

# Ditec COME

IP1775

Manuale di installazione per selettore di funzioni elettronico COME.  
Installation manual for COME electronic functions selector switch.  
Manuel d'installation pour sélecteur de fonctions électronique COME.  
Installationshandbuch für den elektronischen Funktionswahlschalter COME.  
Manual de instalación para el selector de funciones electrónico COME.  
Manual de instalação para selector de funções electrónico COME.

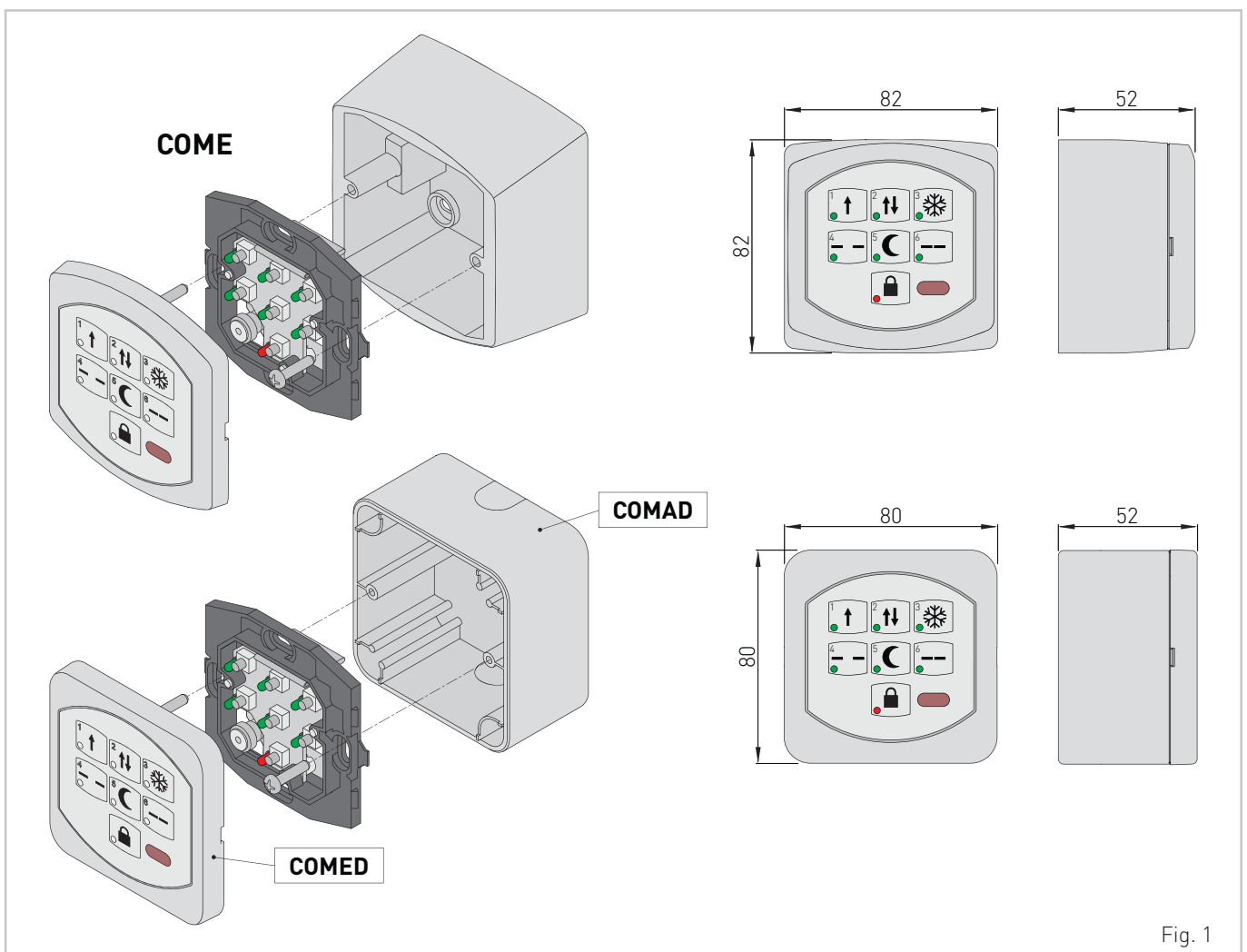

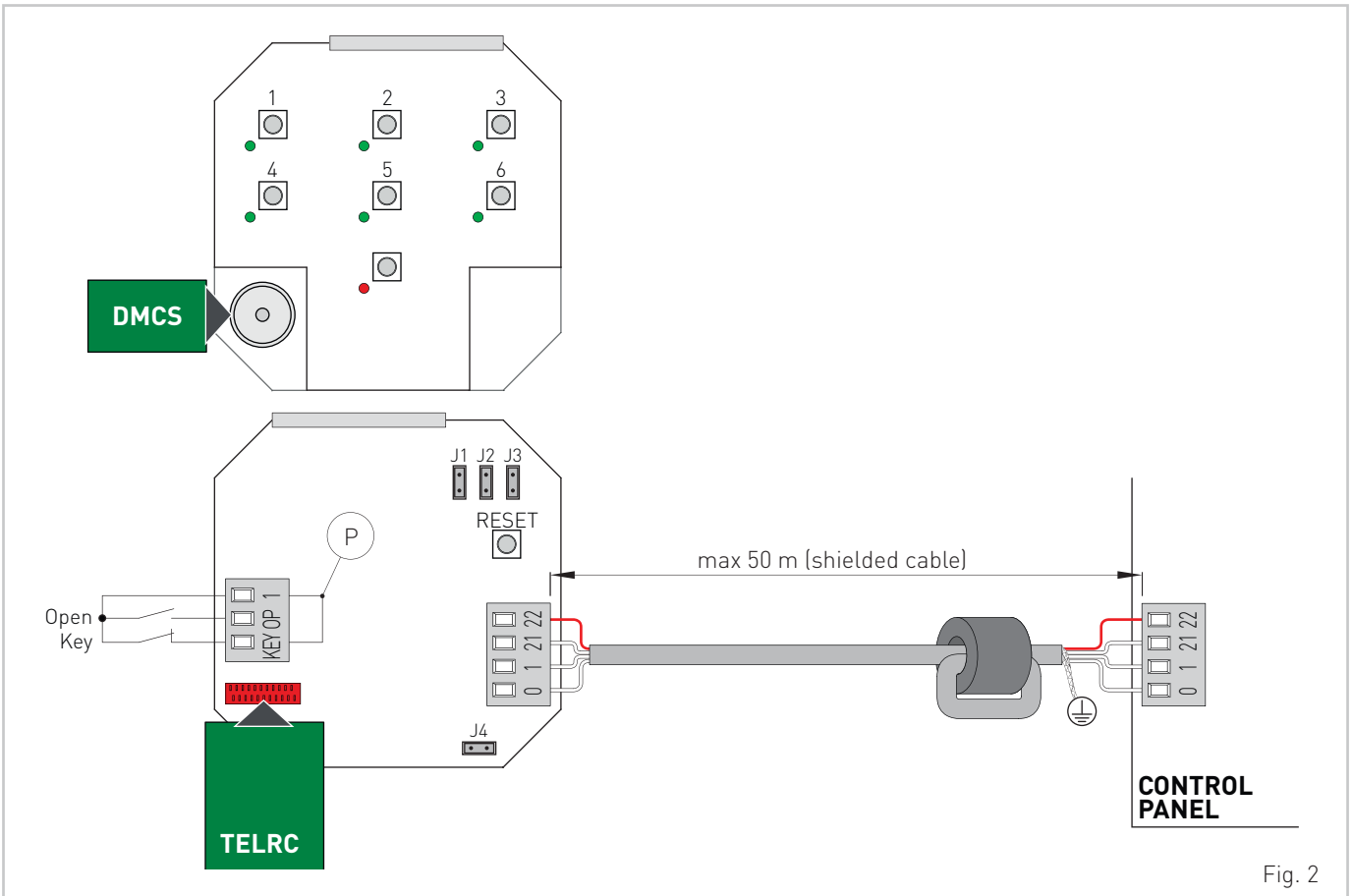

Fig. 2

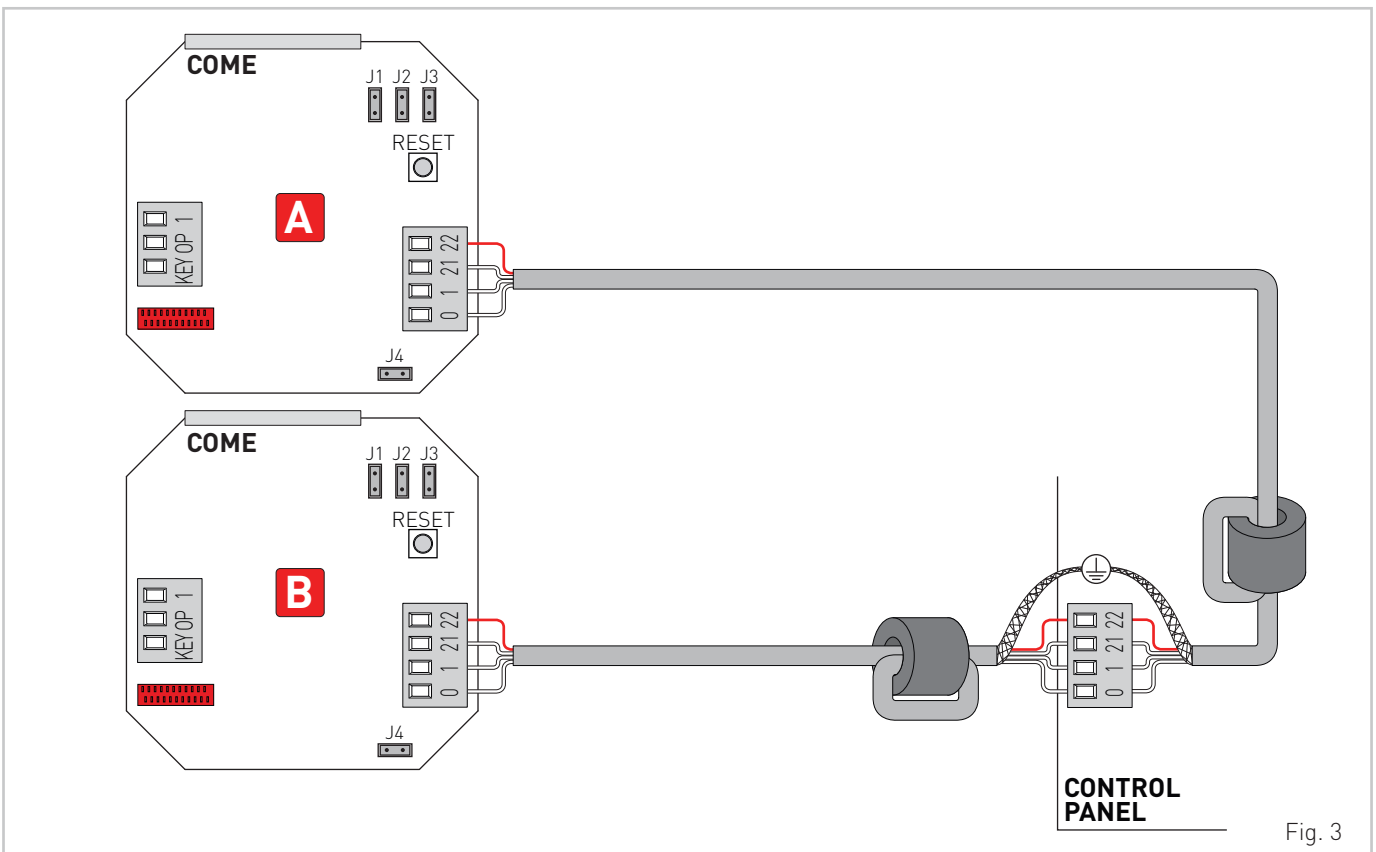
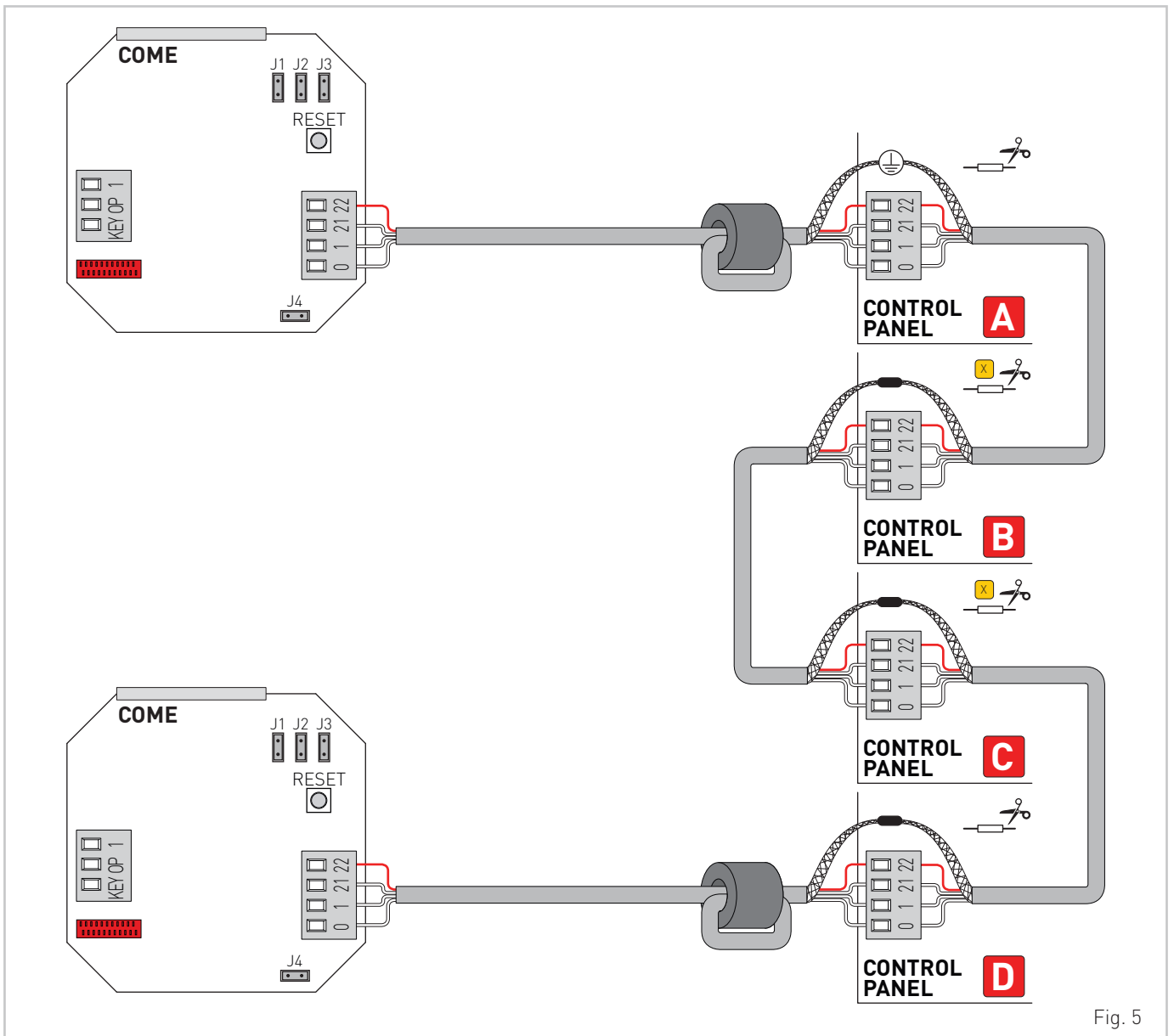
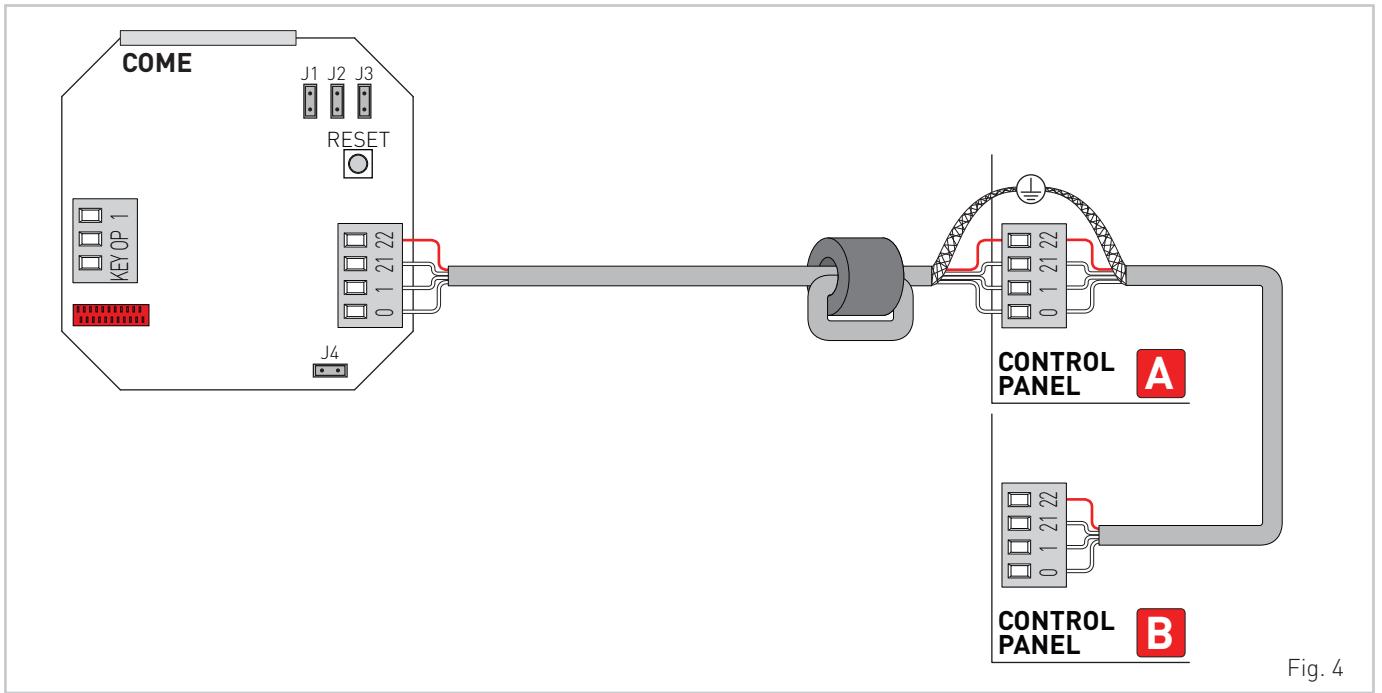



Fig. 3



## General safety precautions

 This installation manual is intended for professionally competent personnel only. Read the instructions carefully before beginning to install the product. Incorrect installation may be a source of danger. Packaging materials (plastic, polystyrene, etc.) must not be allowed to litter the environment and must be kept out of the reach of children for whom they may be a source of danger. Before beginning the installation check that the product is in perfect condition. For repairs or replacements of product only original spare parts must be used. These instruction must be kept and forwarded to all possible future user of the system.

## 1. Technical data

**Degree of protection** IP43  
**Temperature** -20° C / +55° C

## 2. Installation

Properly fasten the COME function selector close to the automation.  
 NOTE: the COME function selector can be wall recessed on circular boxes, not supplied.

## 3. Electrical connections

Carry out the electrical connections as shown in fig. 2.

NOTE: use shielded cable for the electrical connections.

 **WARNING:** in accordance with Directive 2004/108/EC, the supplied ferrites must be installed as shown.

- Pass the cable through the ferrite, make 1 turn and protect it from knocks by using heat-shrink sheathing or similar. The ferrite must be secured to the cable near the terminal boards (approximately 50 mm).
- Two COME function selectors can be connected to one single automation, as shown in fig. 3.
- With one single COME function selector the same function modes can be set in two different automations, by carrying out the electrical connections shown in fig. 4.
- One or two COME function selectors can be connected in order to set the same function modes up to a maximum of four different automations (not redundant type), as shown in fig. 5.

NOTE: for control panel networking, use the shielded cable (not supplied) for data transmission, up to 1000 m total maximum length.



When COME function selector manages more than two automations, cut the resistor  in the intermediate control panels (fig. 5).

- The outlet connecting the automation to the personal computer, through the DMCS software, can be accessed by removing the selector cover (fig. 1). In order to monitor and operate the automation via personal computer, follow the instructions in the DMCS software operating handbook.

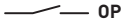

 **WARNING:** if MD1 display modules are used, each MD1 display module must be configured separately with each control panel before connecting to the network.

It is sufficient to supply each control panel for at least 30 seconds with its MD1 display module, then turn off the supply, connect to the network and power all control panels simultaneously.



## 3.1 Commands

Command	Description
1  <b>OP</b>	The closing of the contact opens the automation when the COME functions selector switch is in any operating mode. NOTE: if the operating mode selected is stop, the OPEN command starts the delayed night-time closure sequence.
1  <b>KEY</b>	The opening of the contact deactivates the functions selector switch. WARNING: if an N.C. command is used, remove the jumper [P].
<b>RESET</b> 	Pressing the key eliminates the code set in the functions selector switch.

## 3.2 Settings

	OFF 	ON 
<b>J1</b>	Delayed night locking. 60-second bi-directional sequence.	Delayed night locking. 10-second bi-directional sequence.
<b>J2</b>	Emergency opening. If the OPEN button is held pressed, the COME function selector is set in the open door mode. NOTE: if the function mode selected is stop, the OPEN command triggers the delayed night locking.	Standard opening. Impulse OPEN command.
<b>J3</b>	Access code disabled.	Access code enabled.
<b>J4</b>	DMCS jack disabled.	DMCS jack enabled.

## 3.3 Signals

LED	Description
	<b>LED off</b> The COME function selector is working and no access code is set.
	<b>LED on</b> The COME function selector is protected by an access code. The COME function selector is disabled.
	<b>LED flashing</b> Setting or elimination of access code in progress. Start during the network acquisition phase (for 30 s). The COME function selector or another automation are not recognized by the network (switch off and start again repeating the learning phase).

## 3.4 TELRC infrared beam receiver

Remote adjustment of the control panel settings can be carried out via the TEL2 radio remote control, by installing the TELRC receiver inside the COME function selector as shown in the TELRC receiver handbook.



































## 4. Operation

After having connected the COME function selector and the control panels, turn on all control panels together and wait 30 s.

During the initial learning phase the  key red led flashes and the 1-2-3-4 green leds light up depending on the number of control panels networked. If there are two COME function selectors networked the 6 green led lights up.

Operating modes are shown in the table.

All the rights concerning this material are the exclusive property of Entrematic Group AB. Although the contents of this publication have been drawn up with the greatest care, Entrematic Group AB cannot be held responsible in any way for any damage caused by mistakes or omissions in this publication. We reserve the right to make changes without prior notice. Copying, scanning and changing in any way are expressly forbidden unless authorised in writing by Entrematic Group AB.

Operating modes	Selector without access code 	Selector with access code 
Mono-directional.	Key 1 	CODE ► key 1 
Mono-directional opposite side. (flashing LED).	Key 1  <b>3 s</b>	CODE ► key 1  <b>3 s</b>
Bi-directional.	Key 2 	CODE ► key 2 
Partial opening. (Only for mono-directional and bi-directional). NOTE: if the automation has 2 swinging wings, it allows 1 wing opening only.	Key 3 	CODE ► key 3 
Sliding door open.	Key 4 	CODE ► key 4 
Swing door open.	Key 4 	CODE ► key 4 
Delayed night locking (STOP). Start the sequence: bi-directional (10 s with J1=ON; 60 s with J1=OFF) ◻ door closed (max 60 s) ◻ STOP.	Key 5 	CODE ► key 5 
Immediate night locking (STOP).	Key 5  <b>3 s</b>	CODE ► key 5  <b>3 s</b>
Sliding door closed.	Key 6 	CODE ► key 6 
Swing door closed.	Key 6 	CODE ► key 6 
Opening command.	Key  + any key	Key  + CODE
POWER RESET. Deletes all data learned by the control panel.	Key 1  + key 5 	CODE ► key 1  + key 5 
Code setting (J3=ON). NOTE: the code has a maximum of 5 digits. During the setting operation the red led flashes.	Key  ► CODE  ► key  <b>3 s</b> <b>3 s</b>	
Code erasing (J3=ON) NOTE: during the erasing operation the red led flashes.	Key  ► CODE  ► key  <b>3 s</b> <b>3 s</b>	