

Central heating circulation pumps

SCR 40 - SCR 60 - SCR 80

Technical data

- single-phase motor with a wet rotor
- three rotational speeds
- operating voltage: 1 x 230 V~50 Hz
- max. operating pressure: 10 bar
- media temperature: 5°C to 110°C max.
- ambient temperature: 40°C max.
- protection type: IP 44
- connection: external thread GZ 1", 1 1/4", 1 1/2" (standard), 2"
- length: 180 mm (standard), 130 mm, 110 mm (brass)



The pump has been created to pump warm water in central heating systems, however it can be used to pump liquid media in industrial and commercial usage. The pump may also be a part of a solar heating installation.

The articles are manufactured from the highest quality cast iron and chrome-nickel steel, which guarantees that the products are of high quality. The product has a ceramic bearing ring and a rotor disk made of technical polymer.

Pumps' characteristics

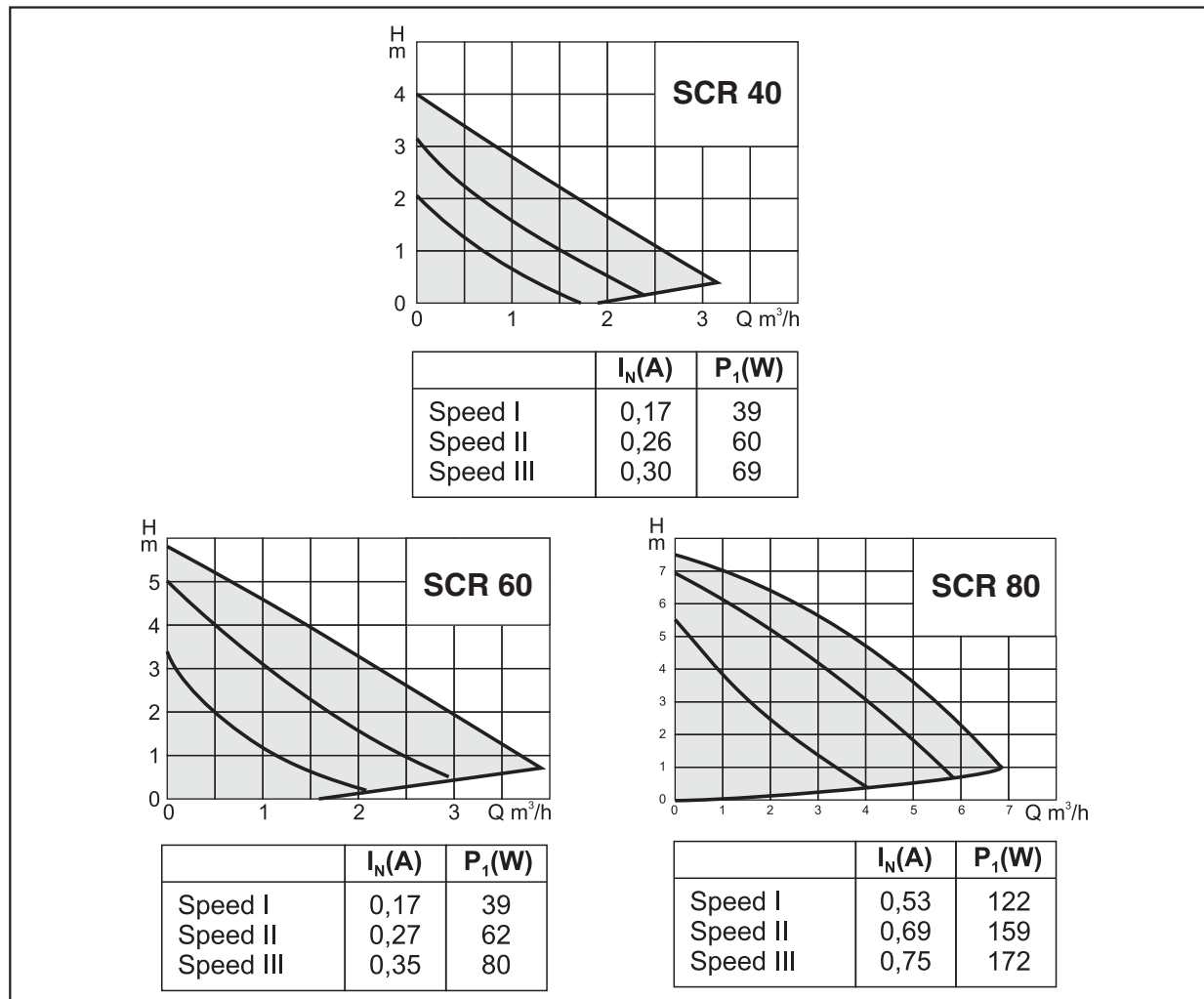

Dimension illustration

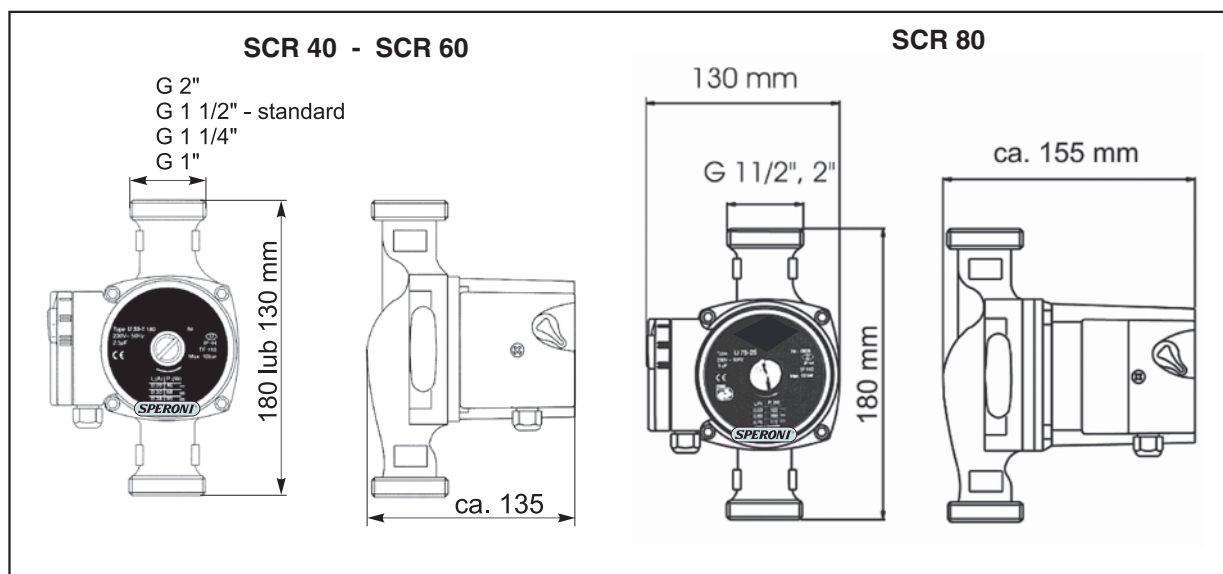

SCR 40

Article	Pump body	Length (mm)	DN	External thread	H(m)	Power consumption (W)
SCR 25/40-180	Cast iron	180	25	G 1 1/2 "	4	28-63
SCR 15/40-130	Cast iron	130	15	G 1 "	4	28-63
SCR 20/40-130	Cast iron	130	20	G 1 1/4"	4	28-63
SCR 25/40-130	Cast iron	130	25	G 1 1/2"	4	28-63
SCR 20/40-180	Cast iron	180	20	G 1 1/4"	4	28-63
SCR 32/40-180	Cast iron	180	32	G 2 "	4	28-63

SCR 60

Article	Pump body	Length (mm)	DN	External thread	H(m)	Power consumption (W)
SCR 25/60-180	Cast iron	180	25	G 1 1/2 "	6	39-80
SCR 15/60-130	Cast iron	130	15	G 1 "	6	39-80
SCR 20/60-130	Cast iron	130	20	G 1 1/4"	6	39-80
SCR 25/60-130	Cast iron	130	25	G 1 1/2"	6	39-80
SCR 20/60-180	Cast iron	180	20	G 1 1/4"	6	39-80
SCR 32/60-180	Cast iron	180	32	G 2 "	6	39-80

SCR 80

Article	Pump body	Length (mm)	DN	External thread	H(m)	Power consumption (W)
SCR 25/80-130	Cast iron	130	25	G 1 1/2 "	8	122-170
SCR 32/80-130	Cast iron	130	32	G 2 "	8	122-170
SCR 25/80-180	Cast iron	180	25	G 1 1/2 "	8	122-170
SCR 32/80-180	Cast iron	180	32	G 2 "	8	122-170

CIRCULATING PUMP



water...is life!



Introduction

Until recently, central heating installations in private house building used mainly gravity water circulation. In such a cycle, the water circulates in the installation thanks to the density difference caused by temperature difference between the supply (the outlet of heated water from the boiler) and the return (the inlet of cool water from the radiators back into the boiler). The faults of such a system include significant inertia, non-uniform distribution of heat and big diameter pipelines. Presence of a pump in a central heating installation allows to reduce considerably the cross section of the wire. Moreover thanks to the automatic system control the fuel consumption decreases. Having a pump in the heating installation helps to reduce capital and operating costs. Pumps designed for central heating installations are equipped with a wet motor, and due to that they are called sealed glandless pumps. The pumped water reduces the friction in slide bearings and cools the motor. Such a construction has many advantages. One of which is no need for constant maintenance. As opposed to gland pumps, they do not require constant maintenance - lubrication or seal replacement. Another advantage is that they are silent running. Silent running has been achieved by using slide bearings in the rotor shaft. Moreover, the turning components of the pump are lipped by water, which also helps to reduce the noise. Glandless pumps are known for their long-term durability. Service life of such a pump is up to 15-20 years, which equals approximately 100 000 hours of work.

We reserve the right to alter technical characteristics of Speroni products at any time without notice, as well as to correct mistakes in our catalogue.

Pumps with rotors working in a liquid medium

In wet-rotor pumps, the rotor is submerged in the medium and at the same time it is a component of the electric motor.

The sleeve sealing the motor is made of high-quality stainless steel and it protects the stator from being flooded. The pump shaft is made of corrosion-resistant material and it is equipped with ceramic/graphite bearings. The pump's sealing is static. The pumped medium fulfils two functions: it cools the pump and reduces the friction in bearings.

Wet-rotor pumps are noiseless and do not require significant expenditure on maintaining them in technical efficiency. Pumps with three rotational speeds, regulated with the use of U type switch, and UE type electronically controlled pumps are also types of wet-rotor pumps.

Selection of a pump

Choosing a pump with three rotational speeds

Characteristic properties of the pumps are shown in the form of characteristic curves illustrating pressure H , power P and the level of pump usage depending on flow Q .

Data on the required pressure flow and drop in the system / installation is included in the project documentation. In order to choose the right pump, the mentioned above data should be compared with technical characteristics of the pumps.

The calculated point R , with the coordinates Q_r and H_r , is the very basis for choosing the right pump. A pump with three rotational speeds has the Q - H characteristics for each speed (see figure 1). The pump operates in the actual working point D .

The estimated point marks at the same time the point of intersection of the hydraulic resistance curve in the installation, and Q - H curve of a certain pump.

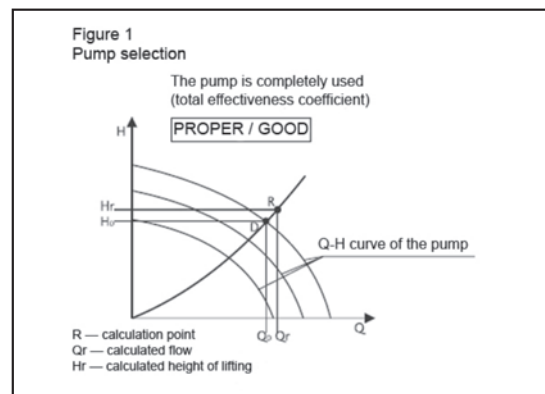

Viscosity of working media

All hydraulic data, as well as other data included in the technical catalogue apply to water as the working media, with the kinematic viscosity of 1 mm²/sec.

If there is no information on working media in the description of a particular pump, then in order to achieve normal functionality of the pump you should provide a pure medium, which is of the same standard as liquid heating water (according to the VDI 2035 requirements specifying water hardness and pH-value) without any aggressive, explosive or mineral oil additives and hard or fibre particles.

Kinematic viscosity of water can be up to 10 mm²/sec.

If viscosity of water ranges from 1 to 10 mm²/sec, then the addition of an antifreeze agent (e.g. glycol) does not influence considerably the functioning of the pump.

Selection of electronically controlled pumps

Functioning of electronically controlled pumps has been adjusted to annual heating energy consumption standards. The average annual consumption is showed in figure 2, illustrating seasonal overload.

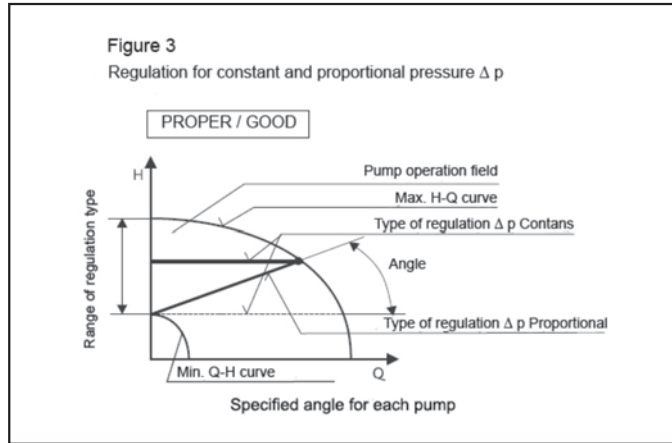
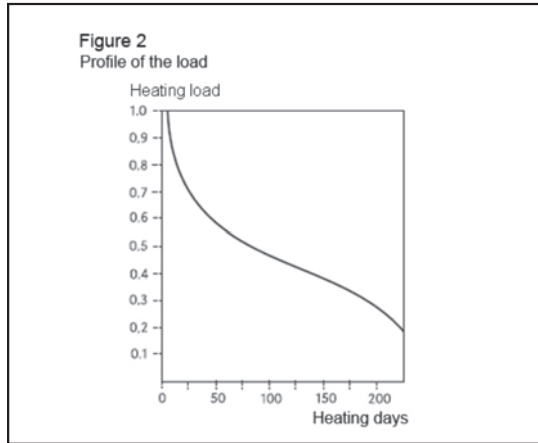

The proper selection of regulated pumps is shown in figures 3, 4 and 5. (Comparison of pump's characteristics determined by the design with actual technical characteristics of a particular pump).

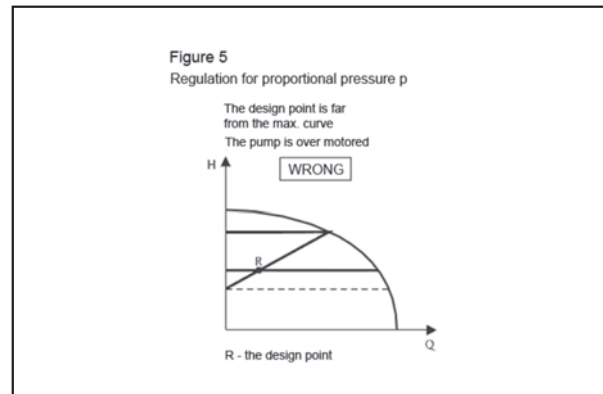
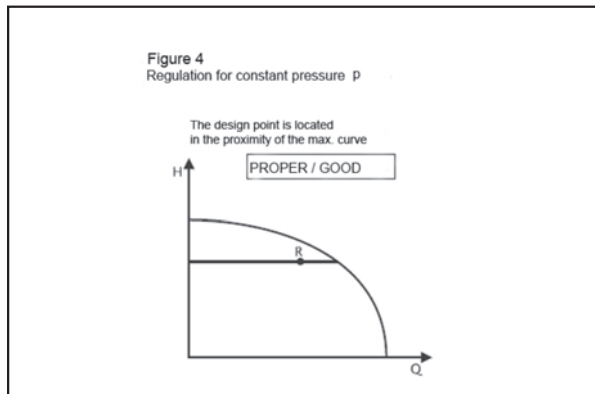

While using regulated pumps you can benefit from the operational field of a particular pump, which ranges from the minimal to the maximal Q-H curves. That is why such a regulation type is called stepless thermal regulation. The R design point should be located as close as possible to the functional max. Q-H curve.

As shown in the figure illustrating the annual heating load, the heating system works on full load of thermal power only for several days throughout the year. Throughout the rest of the year the power consumption is reduced by the electronic pump control system. When it comes to optimal operation of the system (also with the use of thermostatic valves mounted on heating systems), a large amount of energy can be saved thanks to regulated pumps. Therefore, replacing non-regulated pumps with regulated pumps helps to save money and energy. The savings are shown in figure 6.

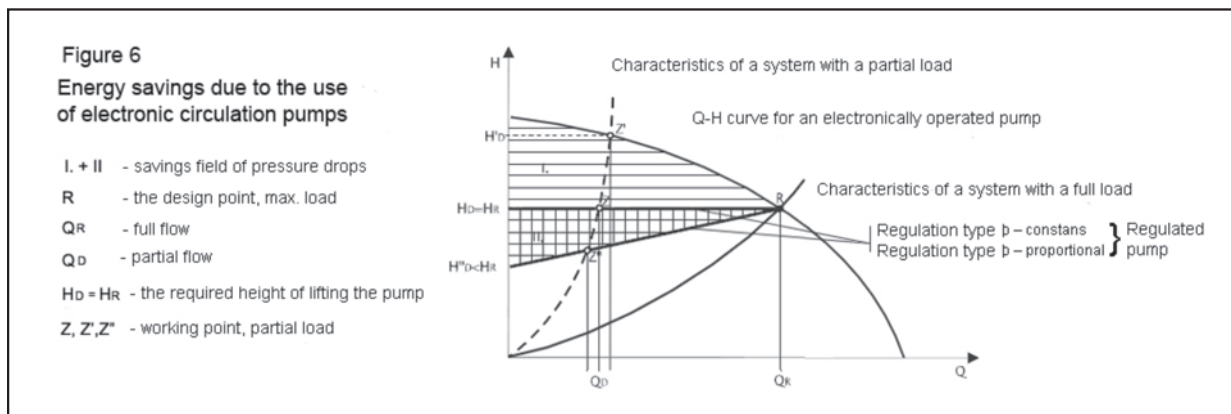

Practical advice

Electrical connection

Connect the electric cables and earthing with a slight sag to the terminal strip, and plug in according to the marking.

- L - phase
- N - neutral conductor
- ⏏ - earthing

External electric protection is not required.

The pump motor can be placed freely at 90° to the pump body, nevertheless it is important that the cable lead is not turned upwards and the terminal box is not located below the motor (see figures 2, A1, A2, A3, A4).

The terminal box connection and the contacts between the box and the motor winding must be protected against humidity. It is forbidden to mount pumps in high humidity rooms.

Starting the pump

In order to reduce the noise, which is caused by the presence of air in a pump, it is necessary to vent the pump properly.

Therefore you should:

- fill the installation with a heating medium
- vent the installation
- open radiator valves to make sure if there is flow in the installation
- start the pump
- change over to the max. rotational speed (speed III)
- twist off the bleeder screw allowing the free flow of air
- eventually turn on the rotational speed

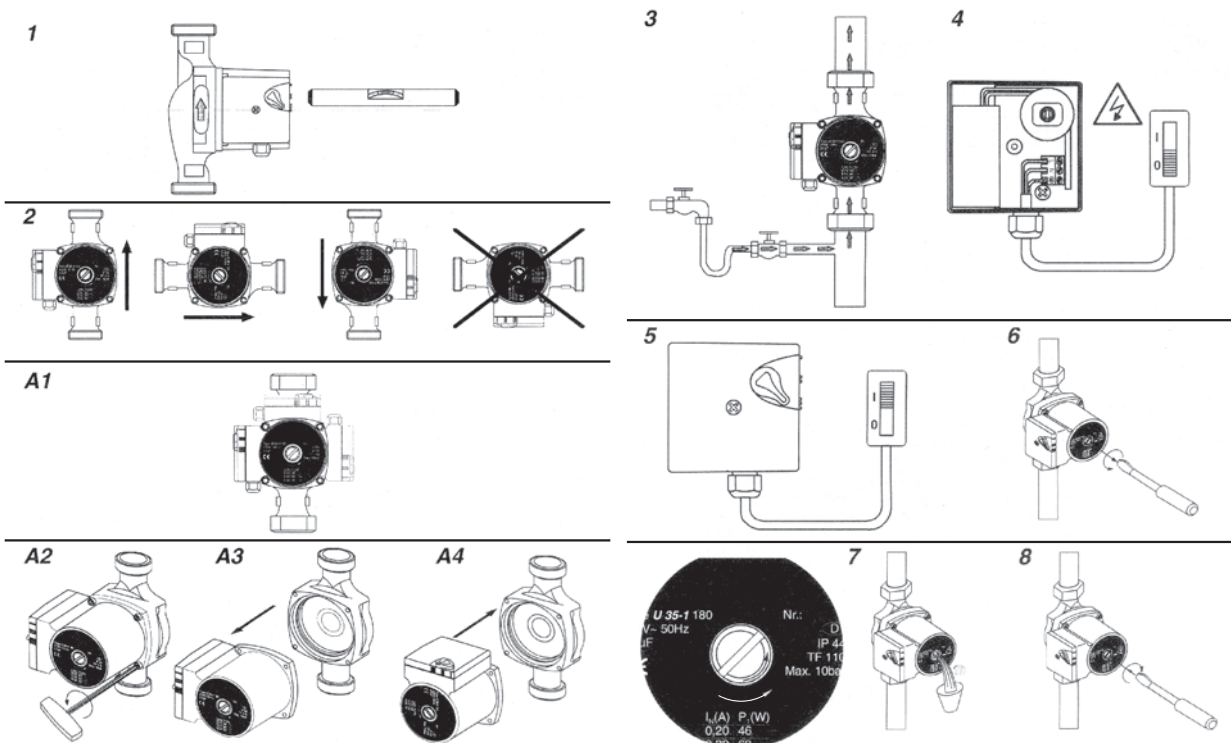

Pump operation

The pump does not require any operation while it is on.

The flow can be controlled by changing the rotational speed with a switch located on the electric box. Adjustments can be made while the pump is operating.

Troubleshooting

Troubleshooting	Cause	Action
Pump is not working	Electricity is not switched on	Check: fuses, loose electrical connections, electric cables
	Capacitor is defective	Replace the capacitor
	Pump fails to start	Change over to max. rotational speed Unlock the rotor - twist off the bleeder screw and turn the pump shaft with a screwdriver Replace the starting capacitor
Poor performance	Dirty rotor	Dismantle the head and clean the rotor
	Air in the pump	Vent the installation Vent the pump Mount an air classifier
	Inlet pressure too low	Increase the inlet pressure Check the air volume in the membrane vessel (if there is any)
	Low rotational speed	Change over to greater rotational speed
Noise in the pump	Air in the pump	Vent the installation Vent the pump Mount an air classifier
	Noise caused by cavitation	Increase the flow pressure Reduce the heating medium temperature Reduce the pump rotational speed Reduce flow on the valve behind the pump
	Too high performance	Reduce the rotational speed