

SKKT 500, SKKH 500

V _{RS}	V _{RRM} V _{DRM}	(dv/dt) _{cr}	I _{TRMS} (maximum values for continuous operation)	
			920 A	
V	V	V/μs	I _{TAV} (sin. 180; T _{case} = 80 °C)	
			585 A	
900	800	500	SKKT 500/08 D	SKKH 500/08 D
1300	1200	1000	SKKT 500/12 E	SKKH 500/12 E
1500	1400	1000	SKKT 500/14 E	SKKH 500/14 E
1700	1600	1000	SKKT 500/16 E	SKKH 500/16 E
1900	1800	1000	SKKT 500/18 E	SKKH 500/18 E

SEMIPACK® 5 Thyristor / Diode Modules

SKKT 500 SKKH 500

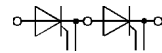

SKKT

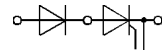

SKKH

Symbol	Conditions	SKKT 500 SKKH 500	Units
I _{TAV}	sin. 180; T _{case} = 85 °C	540	A
I _D	T _{case} = 89 °C	500	A
I _{RMS}	B2/B6	665 / 845	A
	W1/W3	P 16/200 F P 16/300 F	850 / 3 x 670
I _{TSM}	T _{vj} = 25 °C; 10 ms	17 000	A
	T _{vj} = 130 °C; 10 ms	15 000	A
i ² t	T _{vj} = 25 °C; 8,3 ... 10 ms	1 445 000	A ² s
	T _{vj} = 130 °C; 8,3 ... 10 ms	1 125 000	A ² s
t _{gd}	T _{vj} = 25 °C I _G = 1 A di _G /dt = 1 A/μs	1	μs
t _{gr}	V _D = 0,67 · V _{DRM}	2	μs
(di/dt) _{cr}	T _{vj} = 130 °C	200	A/μs
t _q	T _{vj} = 130 °C	typ. 100 ... 200	μs
I _H	T _{vj} = 25 °C; typ./max.	150 / 500	mA
I _L	T _{vj} = 25 °C; R _G = 33 Ω; typ./max.	0,3 / 2	A
V _T	T _{vj} = 25 °C; I _T = 1700 A	max. 1,5	V
V _{T(TO)}	T _{vj} = 130 °C	0,925	V
r _T	T _{vj} = 130 °C	0,27	mΩ
I _{DD} ; I _{RD}	T _{vj} = 130 °C; V _{RD} = V _{RRM} V _{DD} = V _{DRM}	100	mA
V _{GT}	T _{vj} = 25 °C; d.c.	3	V
I _{GT}	T _{vj} = 25 °C; d.c.	200	mA
V _{GD}	T _{vj} = 130 °C; d.c.	0,25	V
I _{GD}	T _{vj} = 130 °C; d.c.	10	mA
R _{thjc}	cont. } per thyristor / sin. 180 } per module rec. 120 }	0,062 / 0,031 0,065 / 0,0325 0,070 / 0,035	°C/W °C/W °C/W
R _{thch}		0,02 / 0,01	°C/W
T _{vj}		- 40 ... + 130	°C
T _{stg}		- 40 ... + 130	°C
V _{isol}	a. c. 50 Hz; r.m.s.; 1 s/1 min	3600/3000	V~
M ₁	to heatsink(M6)	5 ± 15 % ¹⁾	Nm
	SI units	44 ± 15 % ¹⁾	lb.in.
M ₂	to terminals(M10)	12 ± 15 % ²⁾	Nm
	SI units	106 ± 15 % ²⁾	lb.in.
a		5 · 9,81	m/s ²
w	approx.	1420	g
Case		SKKT 500: A 60 SKKH 500: A 66	

Features

- Heat transfer through aluminium nitride ceramic isolated metal baseplate
- Precise metal pressure contacts for high reliability
- UL recognized, file no. E 63 532

Typical Applications

- AC motor softstarters
- Input converters for AC inverter drives
- DC motor control (e.g. for machine tools)
- Temperature control (e.g. for ovens, chemical processes)
- Professional light dimming (studios, theaters)

¹⁾ See the assembly instructions
²⁾ The screws must be lubricated

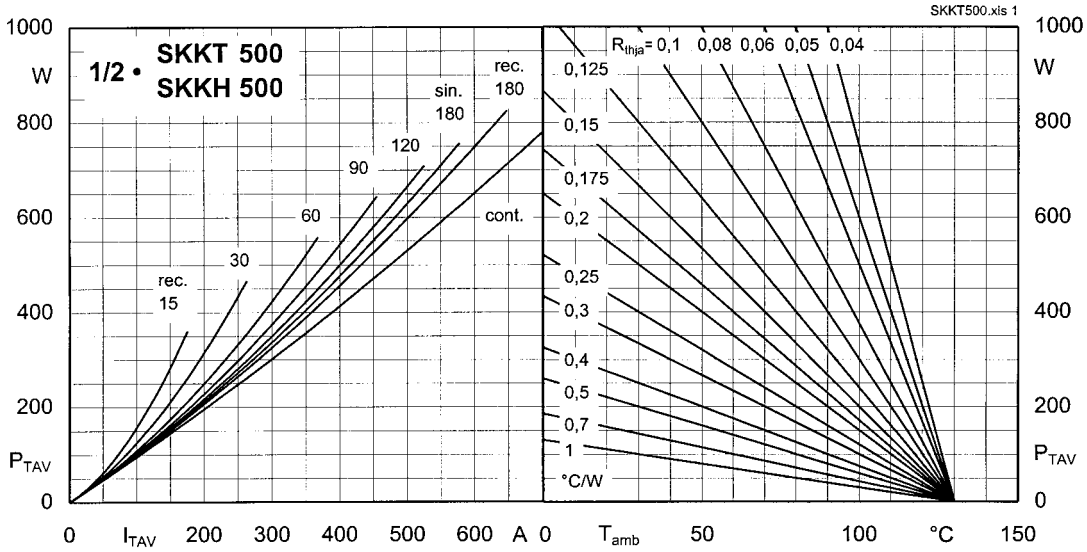

Fig. 1 Power dissipation per thyristor vs. on-state current and ambient temperature

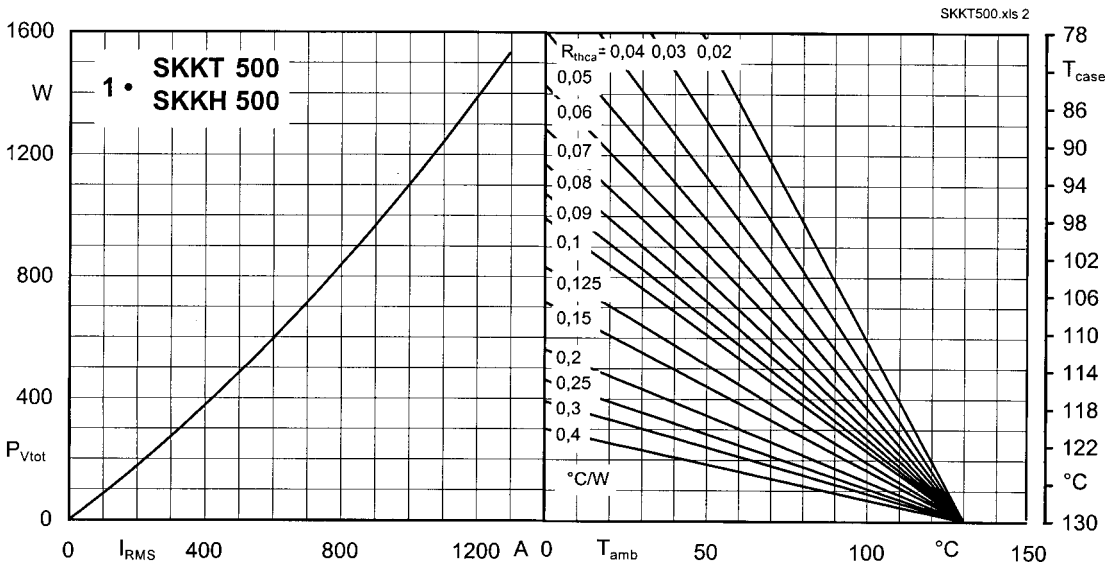

Fig. 2 Power dissipation per module vs. rms current and case temperature

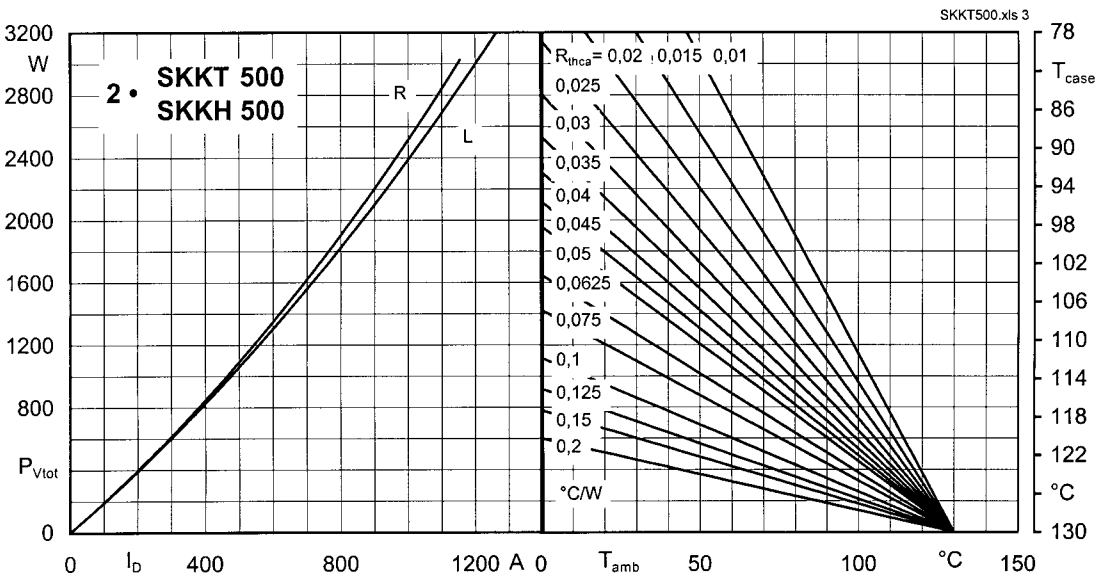

Fig. 3 Power dissipation of two module vs. direct current and case temperature

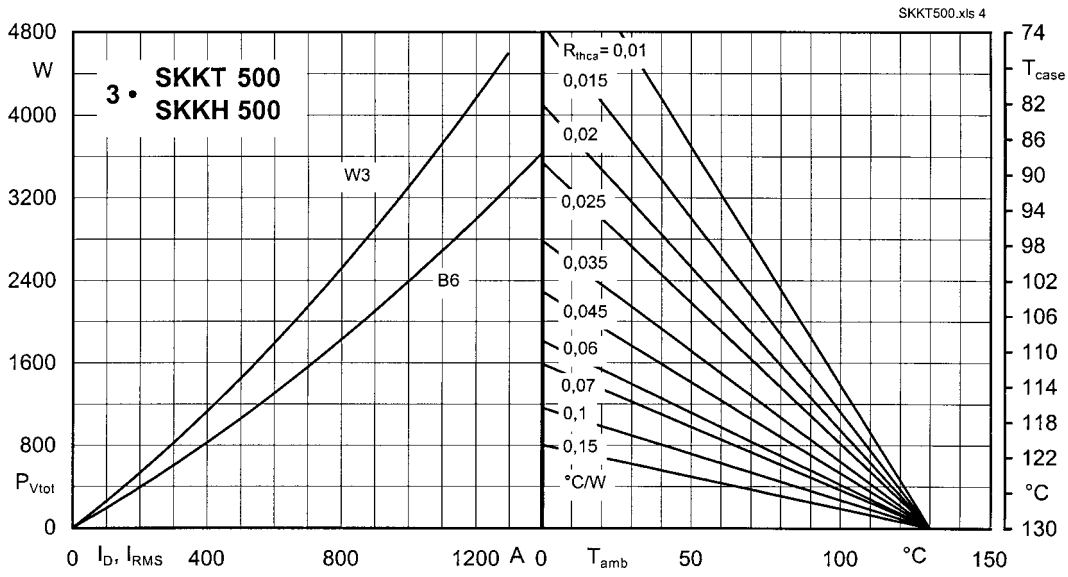

Fig. 4 Power dissipation of three modules vs. direct and rms current and case temperature

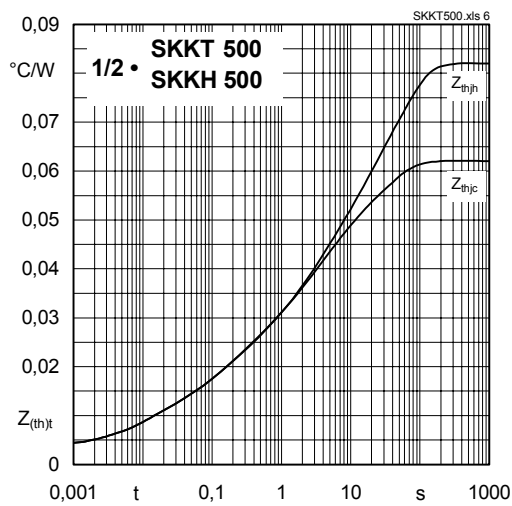

Fig. 6 Transient thermal impedance vs. time

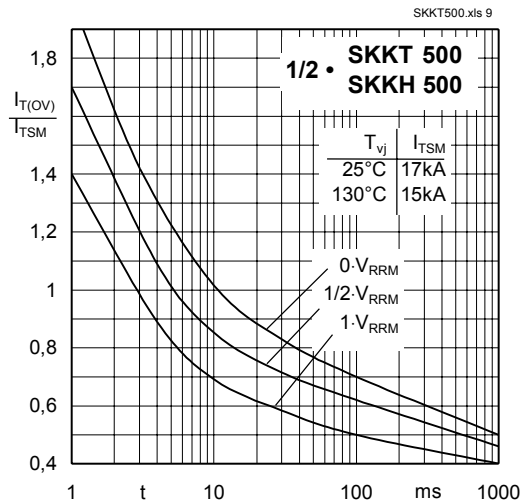

Fig. 9 Surge overload current vs. time

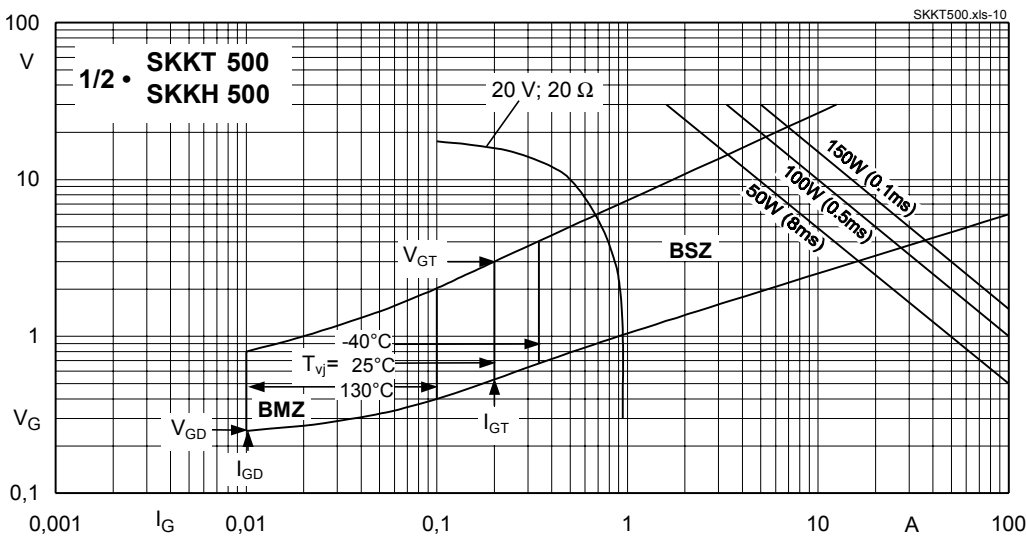

Fig. 10 Gate trigger characteristics

SKKT 500, SKKH 500

SKKT 500

Case A 60
SEMIPACK® 5

UL recognized, file no. E 63 532

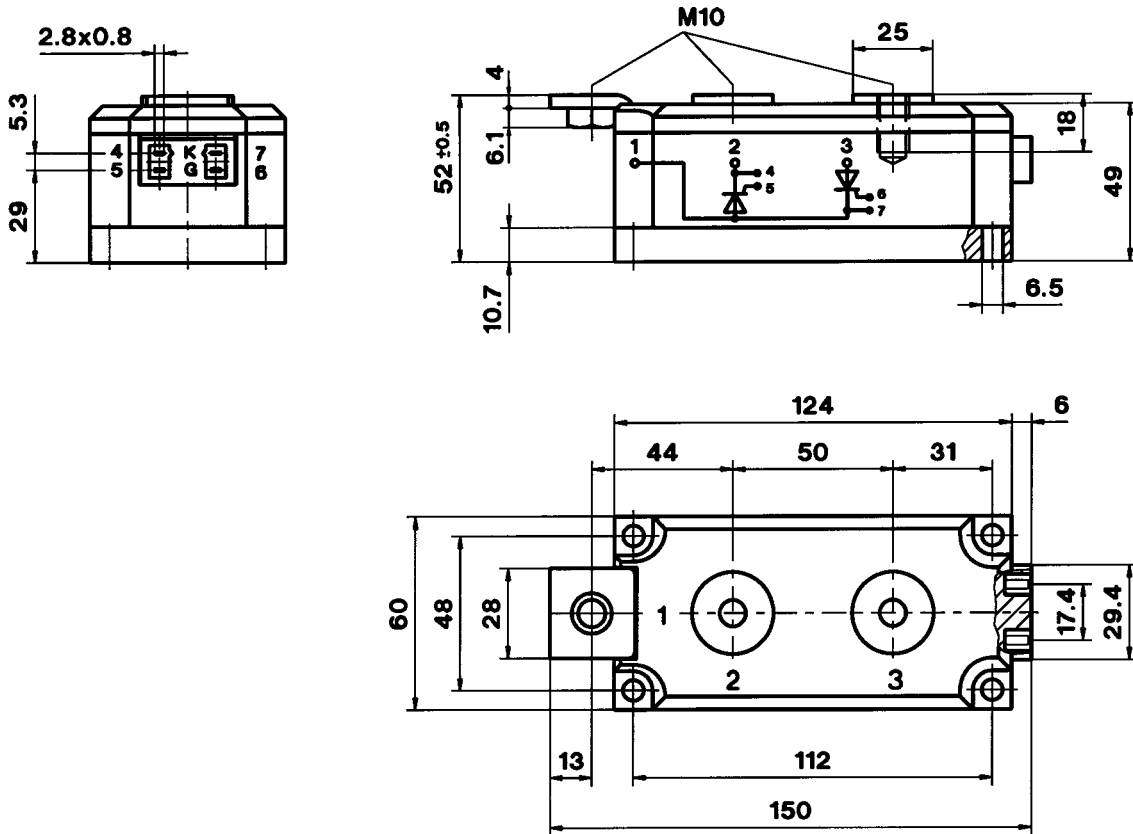

Dimensions in mm

SKKH 500

Case A 66

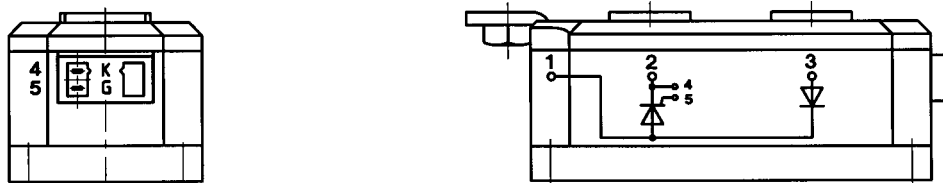

This technical information specifies semiconductor devices but promises no characteristics. No warranty or guarantee expressed or implied is made regarding delivery, performance or suitability.