

Models		DN [mm]	Kvs m <sup>3</sup> /h	Stroke [mm]
2-way	3-way			
VSB1F	VMB1F	15	1,6	16,5
VSB11F	VMB11F		1	
VSB15F	VMB15F		2,5	
VSB2F	VMB2F		4	
VSB3F	VMB3F	20	6,3	
VSB4F	VMB4F	25	10	
VSB5F	VMB5F	32	16	
VSB6F	VMB6F	40	22	
VSB8F	VMB8F	50	30	
VSB8AF	VMB8AF		40	

100 kPa = 1 bar = 10 m H<sub>2</sub>O

### APPLICATION AND USE

Two-way VSB.F and three-way VMB.F valves can be used either for control or fluid detection in air-conditioning, thermoventilation and heating plants, both environmental and industrial, in machines for product thermal process.

Three-way valves should be used only as mixing valves; angle way should never be used for control purposes.

### MANUFACTURING CHARACTERISTICS

The valve body is in G25 cast iron (only DN15 valves have brass body and fitting). The plug is in brass with Contoured-type profile on direct way and V-port on angle way.

The stem is in CrNi steel with threaded M8 end. There are PN16 flanged connections and slip-on flanges. The stem packing is constituted by EPDM O-ring with graphited teflon scraper rings.

**NOTE: The valves are also available in the stainless steel plug version (profile and Kvs are the same of the brass plug). For further sales information, please contact our Sales Support.**

### TECHNICAL CHARACTERISTICS

Body rating 1600 kPa max (16 bar)

Control characteristics

#### DN15÷50

VSB.F-VMB.F direct way equal-percentage

VMB.F angle way linear

#### DN65

VSB.F-VMB.F linear

Leakage\*

VSB.F-VMB.F direct way 0...0,03% of Kvs

VMB.F angle way 0...2% of Kvs

Connections

PN16 flanged

Stroke

16,5 mm (max 18,5)

Allowed fluids

- water

max. temperature 150 °C

min. temperature -10 °C (in case of ice on stem and gasket, use the stem-heater, see actuators data sheets; it is not applicable to V\_B.F Ø 15 valves)

glycol added max 50%

- saturated steam

max. temperature 150 °C

max. pressure 1,5 bar (absolute value)

Weight

See overall dimensions

\* Leakage is measured according to the EN1349 standard.



**NOTE: If V.B.F valves are assembled with MVB+spacer (MVBHT) the max. operating temperature is 140 °C, while without spacer is 120 °C. For other actuators the max. operating temperature is 150 °C.**

### OPERATION

When stem is up, the direct way is closed, with stem down direct way is open.

### INSTALLATION

Before valves are mounted, make sure that pipes are clean, free from welding slags, that are perfectly lined up with the valve body and not subjected to vibrations.

The valve can be mounted in any position except upside-down (for MVH actuators see Fig. 3).

While assembling, respect the flow directions indicated by the letters located on the valve body (see Figures 1 and 2) and the application schemes.

N4060

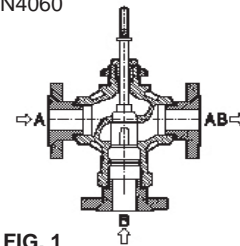

FIG. 1

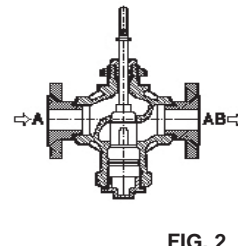
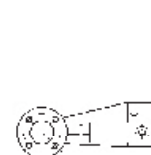

FIG. 2

### MOUNTING POSITIONS



FIG. 3



YES

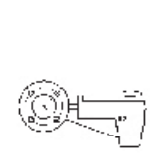

NO

N4062

**For V.B.F DN15 only: the actuator must be rotated 90° with respect to the valve, as shown by Fig. 4**

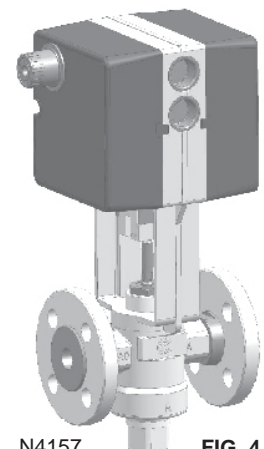

N4157

FIG. 4

**ACTUATORS**

VSB.F and VMB.F are controlled by CONTROLLI MVB, MVF, MVH, MVH56FA/C, MVE actuators.

**ACCESSORIES**

- AG52 Mounting kit for MVF actuator
- AG62 Mounting kit for MVH actuator
- AG63 Mounting kit for MVF..S actuator
- GVB3 Thermal insulation for DN20 valves (V.B3F)
- GVB4 Thermal insulation for DN25 valves (V.B4F)
- GVB5 Thermal insulation for DN32 valves (V.B5F)
- GVB6 Thermal insulation for DN40 valves (V.B6F)
- GVB8 Thermal insulation for DN50 valves (V.B8F)
- GVB8A Thermal insulation for DN50 valves (V.B8AF)

**MAX DIFFERENTIAL PRESSURE (kPa)**

		MVH		MVHA/C*		MVB		MVF54		MVF58		MVF515		MVF59A/C		MVEX06		MVEX10	
U-Bolt Connection	DN	A-AB	B-AB	A-AB	B-AB	A-AB	B-AB	A-AB	B-AB	A-AB	B-AB	A-AB	B-AB	A-AB	B-AB	A-AB	B-AB	A-AB	B-AB
	VSBF VMBF	1/2"	1600	1600	1600	1600	-	-	1490	1140	1600	1600	1600	1600	1600	1600	1600	1600	1600
3/4"		1600	1600	1600	1560	1080	260	1210	760	1600	1600	1600	1600	1600	1600	1600	1310	1600	1600
1"		1600	1600	1380	1030	680	170	760	500	1560	1190	1600	1600	1600	1360	1190	870	1600	1560
1 1/4"		1600	1370	840	650	410	110	460	320	950	750	1600	1500	1070	860	720	540	1210	980
1 1/2"		1170	990	590	470	290	80	320	230	670	540	1270	1090	750	620	500	390	860	710
2"		870	750	440	350	210	60	240	170	490	410	950	820	560	470	370	290	640	540

DP max = max differential pressure value ensured by the actuator for regular operation

**Note:** in case of lack of voltage, with MVH56FA direct way is closed, with MVH56FC angle way is closed.

**APPLICATION SCHEMES**

VSB.F VALVES

a) Variable flow control when used

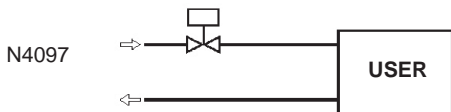

b) Constant flow when used in injection circuits

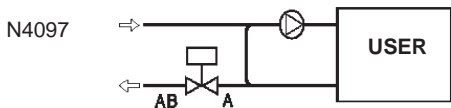

VMB.F VALVES

c) Variable flow mixing when used

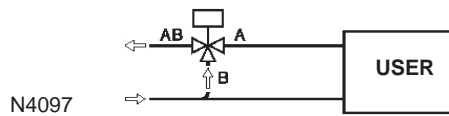

d) Constant flow mixing when used in injection or tapping circuits

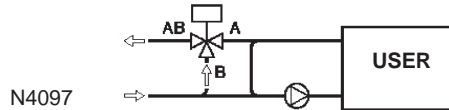

**OVERALL DIMENSIONS (mm.)**

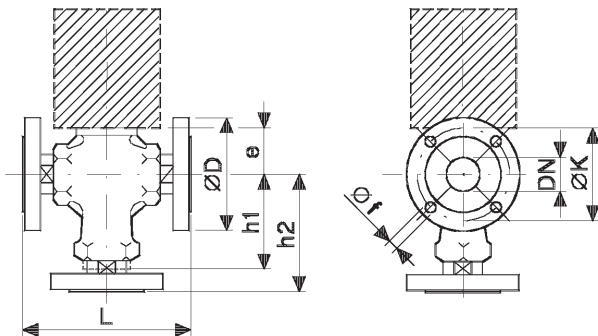

DN	Ø D	Ø K	Ø f	Fori	L	VSB.F/VMB.F		Peso [Kg]	
						h1	h2	VSB.F	VMB.F
15*	95	65	14	4	130	70	95	2,9	3,6
20	105	75	14	150	150	79	100	3,5	4,5
25	115	85	14	160	160	83	105	4,3	5,5
32	140	100	18	180	180	90	114,5	6,2	8
40	150	110	18	200	200	98	125,5	7,5	9,8
50 (V.B8AF)	165	125	18	254	254	111	127	11,5	14,2
50 (V.B8F)	165	125	18	230	230	111	141	11,5	14,2

\*See note on Fig. 4

The performances stated in this sheet can be modified without any prior notice due to design improvements