

R1.1,item L34

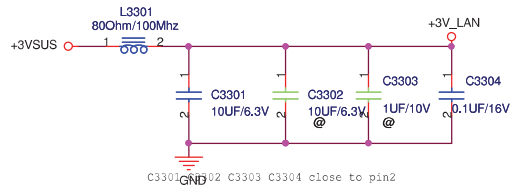

For Design IP: R3325: 0 Ohm

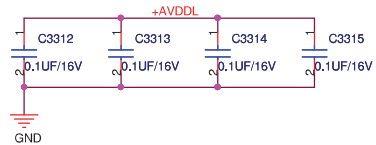
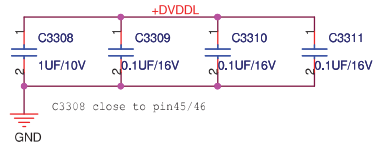
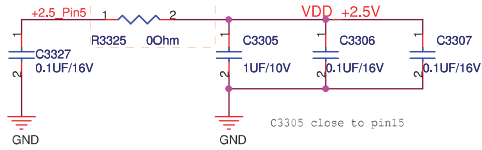

AR8131 with overclock: Remove R3315, R3303
Not overclock: Remove R3304

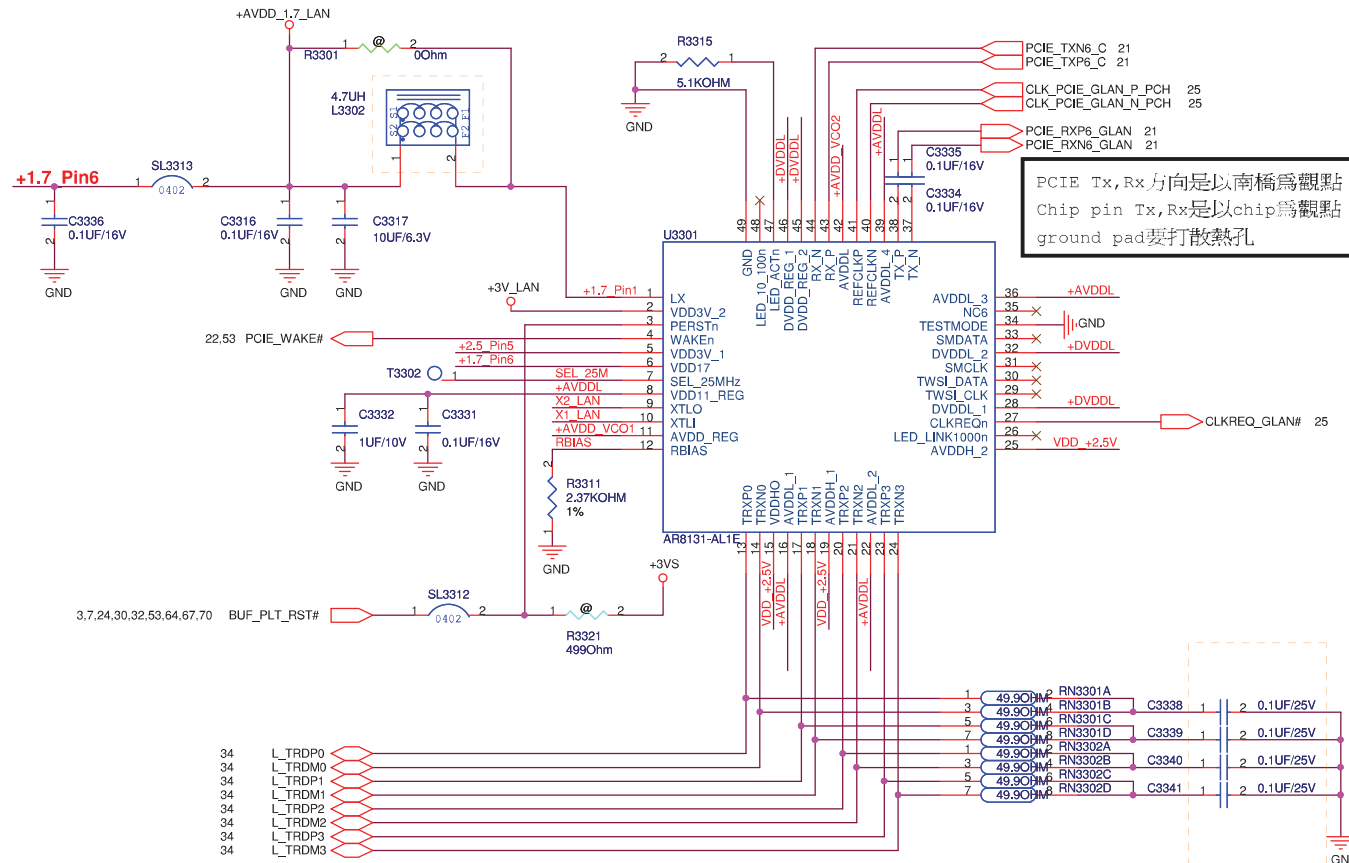
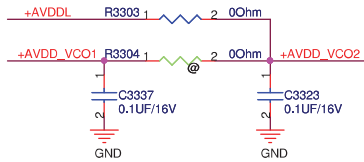

AR8131/25MHz: Remove C3328

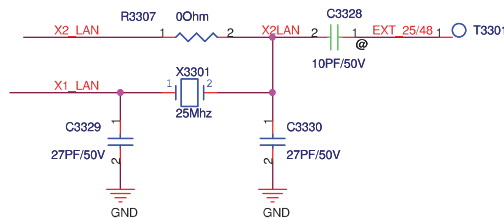

ASUS		Title : LAN-AR8131	
ASUSTek COMPUTER INC. NB4		Engineer: Jerry Mou	
Size B	Project Name K72Jr		Rev 2.0
Date: Friday, December 11, 2009	Sheet 33 of 100		