

ASB-2

S O U N D B A R

- EN** - Quick Start Guide
- FR** - Guide de démarrage rapide
- IT** - Guida rapida
- DE** - Schnellstartanleitung
- ES** - Guía de inicio rápido
- PT** - Guia de Início Rápido
- NL** - Snelstarthandleiding
- 中文** - 快速入门指南
- RU** - Руководство по быстрой установке

EN Table Stand
FR Support pour table
IT Supporto da tavolo
DE Tischaufstellung
ES Soporte para mesa

PT Suporte para mesa
NL Tafelstandaard
中文 座台脚
RU Подставка для установки на столе

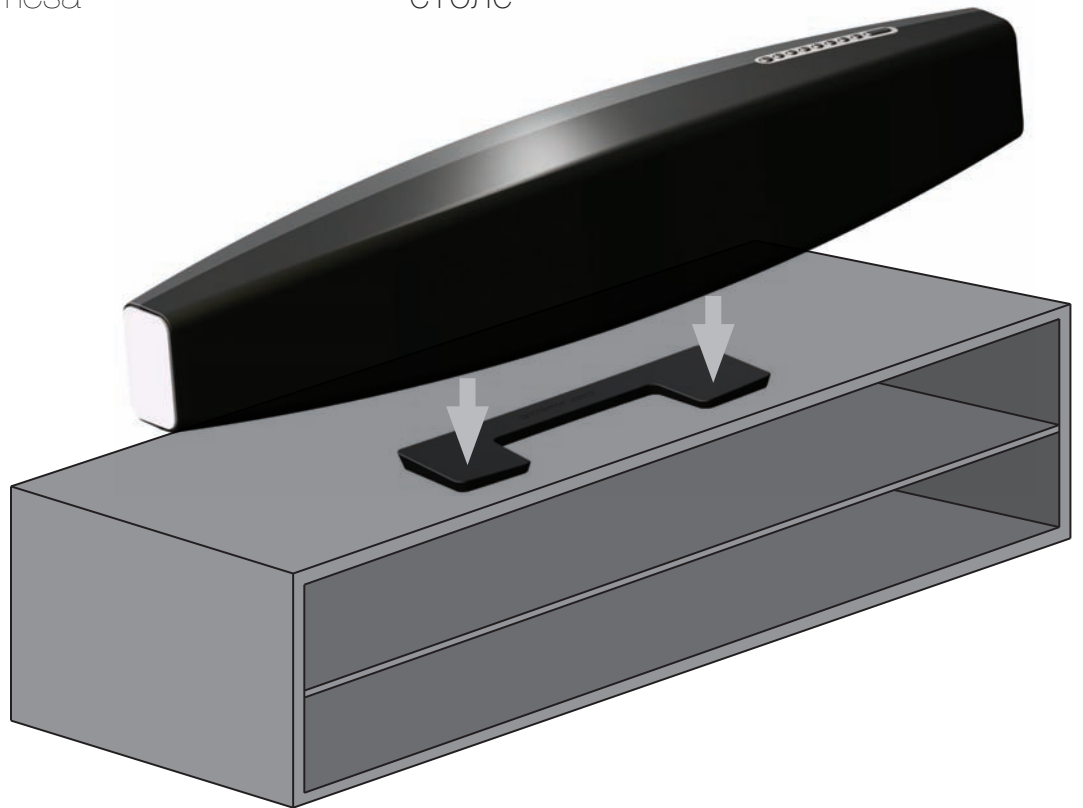

EN Wall Mounting
FR Placement sur un mur
IT Montaggio su muro
DE Wandbefestigung
ES Montaje en pared

PT Montagem na parede
NL Muursteun
中文 壁式安装
RU Кронштейн для крепления на стену

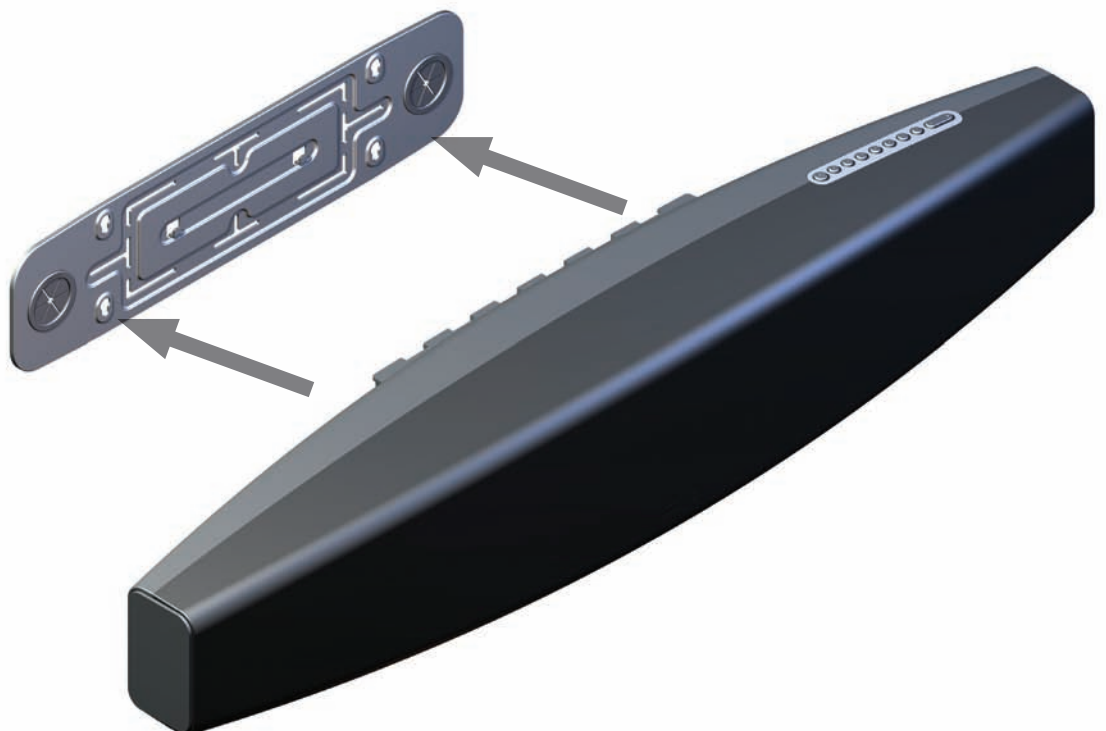

EN Connecting to a TV



NOTE: Do not connect the power to the ABS-2 until you have made all of your audio/video connections.

PT Ligar a um televisor



NOTA: Não colocar o ABS2 em funcionamento até terem sido efetuadas todas as ligações de áudio/vídeo.

FR Connexion à une télévision



REMARQUE : Ne branchez pas l'alimentation de l'ABS2 avant d'avoir effectué toutes les connexions audio/vidéo.

NL Aansluiten op de televisie



LET OP: sluit de ASB2 niet aan op het stroomnet tot alle audio- en videoverbindingen zijn aangesloten

IT Connessione a un apparecchio TV



NOTA BENE: non collegare l'alimentazione all'ABS2 finché non sono state effettuate tutte le connessioni audio/video.

中文 连接电视



注意：先连接音频/视频，然后再连接ABS2电源。

DE Verbindung mit einem Fernseher



HINWEIS: Verbinden Sie die ABS2 erst mit dem Stromnetz, nachdem Sie alle Audio- und Videoverbindungen eingerichtet haben.

RU Подключение к телевизору



ПРИМЕЧАНИЕ: не подключайте питание ABS-2 до завершения всех аудио-видео соединений

ES Conexión a la TV



NOTA: No conecte el ABS2 a la corriente hasta que haya llevado a cabo todas las conexiones de audio / vídeo.

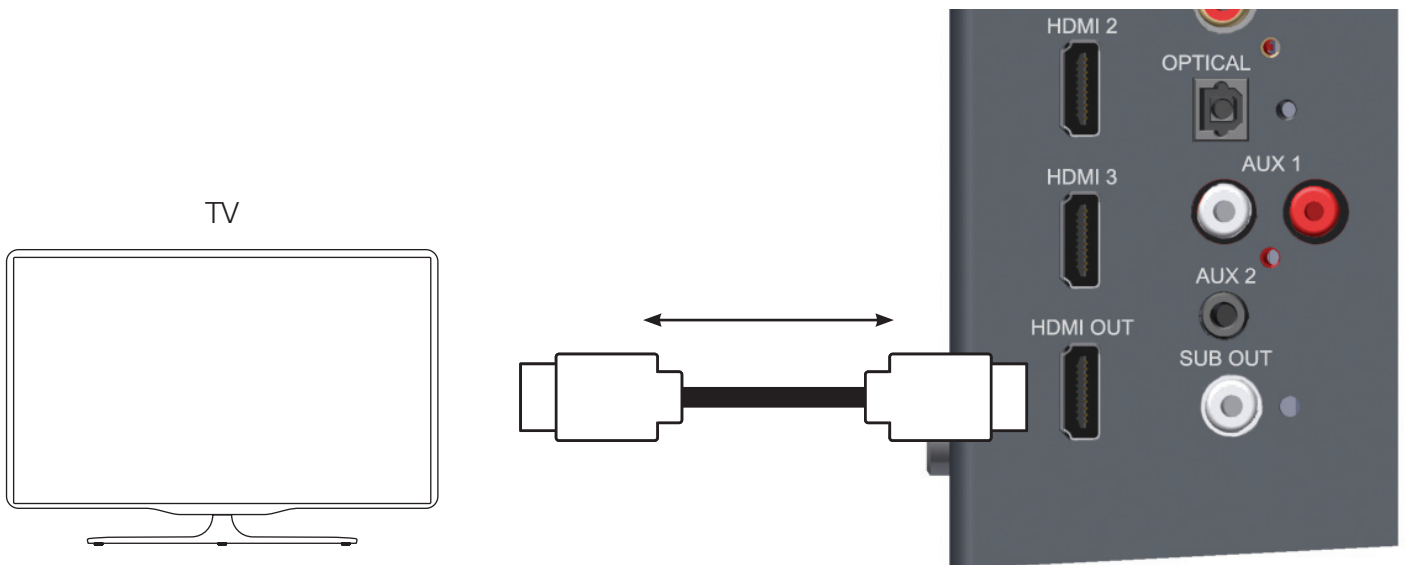

EN Connecting Digital Devices Via HDMI
Examples of HDMI connection:

FR Connexion d'appareils numériques via HDMI

Exemples de connexion HDMI :

IT Connessione di dispositivi digitali tramite HDMI

Esempi di connessione HDMI:

DE Verbindung digitaler Geräte über HDMI
Beispiele einer HDMI-Verbindung:

ES Conexión de dispositivos digitales mediante HDMI

Ejemplos de conexión HDMI:

PT Ligar dispositivos digitais via HDMI

Exemplos de ligação HDMI:

NL Aansluiten digitale apparatuur via HDMI
Voorbeelden van HDMI-aansluiting:

中文 高清晰度多媒体接口连接数码设备
高清晰度多媒体接口连接案例:

RU Подключение цифровых устройств через интерфейс HDMI
Примеры HDMI-соединений:

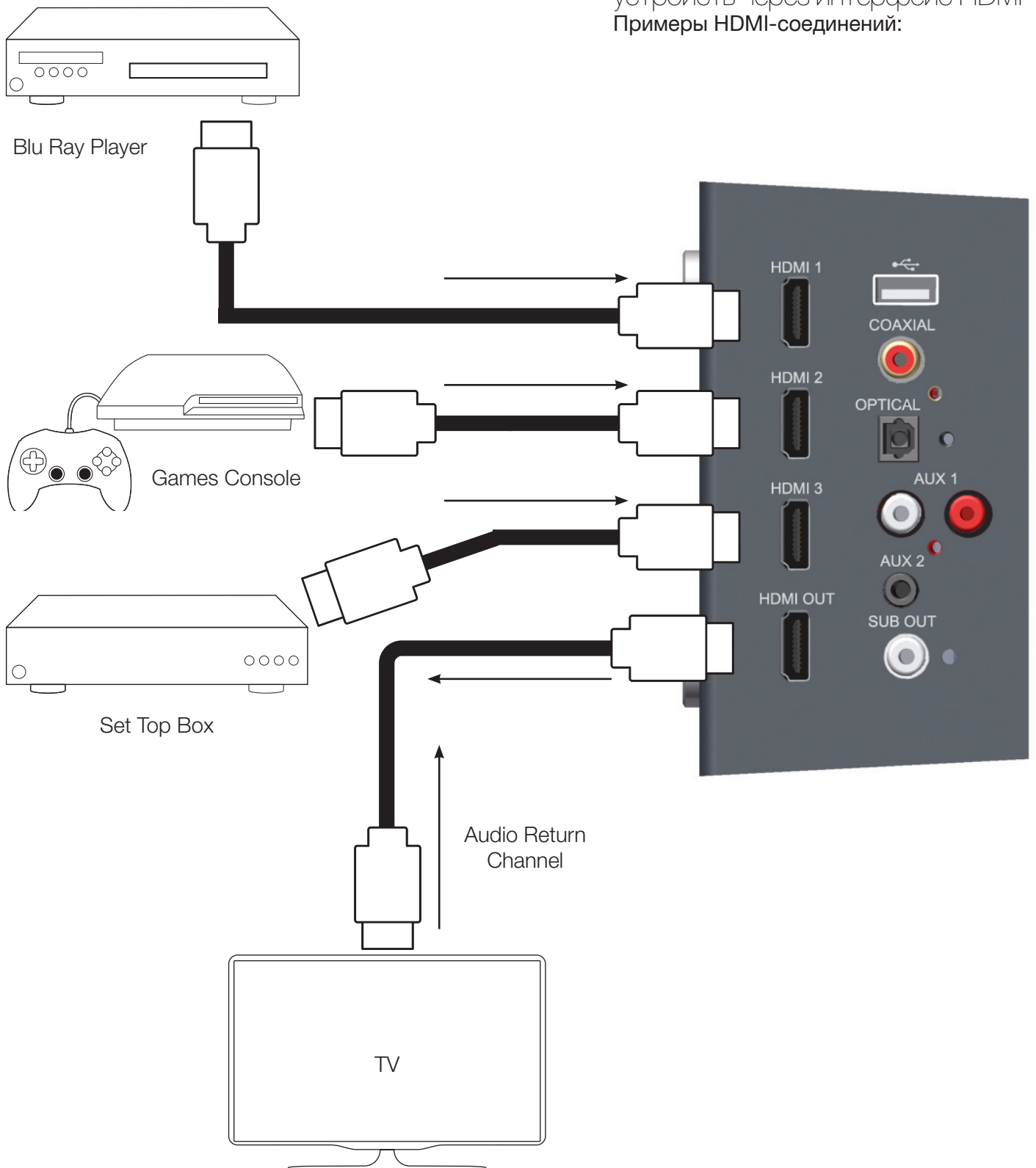

EN Connecting Audio Devices Via Digital Input

FR Connexion d'appareils audio via l'entrée numérique

IT Connessione di dispositivi digitali tramite input digitali

DE Verbindung von Audiogeräten über den digitalen Eingang

ES Conexión de dispositivos de audio mediante la entrada digital

PT Ligar dispositivos digitais através da entrada digital

NL Aansluiten audioapparatuur via digitale input

中文 通过数码输入连接音频设备

RU Подключение устройств к цифровым аудиовходам

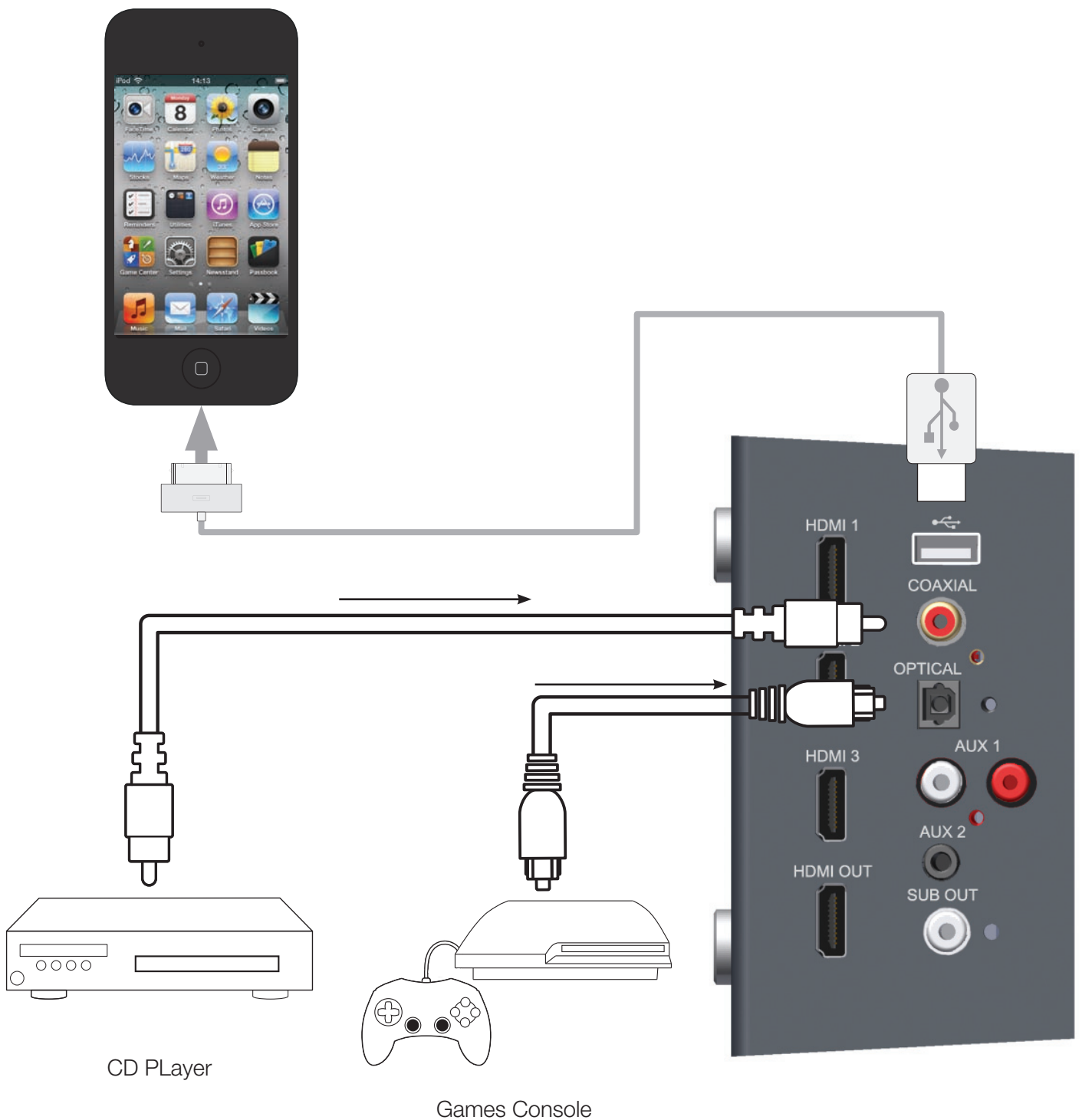

EN Connecting Analog Audio Devices Via Coaxial Input

FR Connexion d'appareils audio analogiques via l'entrée coaxiale

IT Connessione di dispositivi analogici tramite input coassiale

DE Verbindung analoger Audiogeräte über den Koaxialeingang

ES Conexión de dispositivos de audio analógico mediante la entrada coaxial

PT Ligar dispositivos analógicos através da entrada coaxial

NL Aansluiten analoge audioapparatuur via coaxiale input

中文 通过同轴输入连接捕获模拟音频设备

RU Подключение устройств к аналоговым аудиовходам

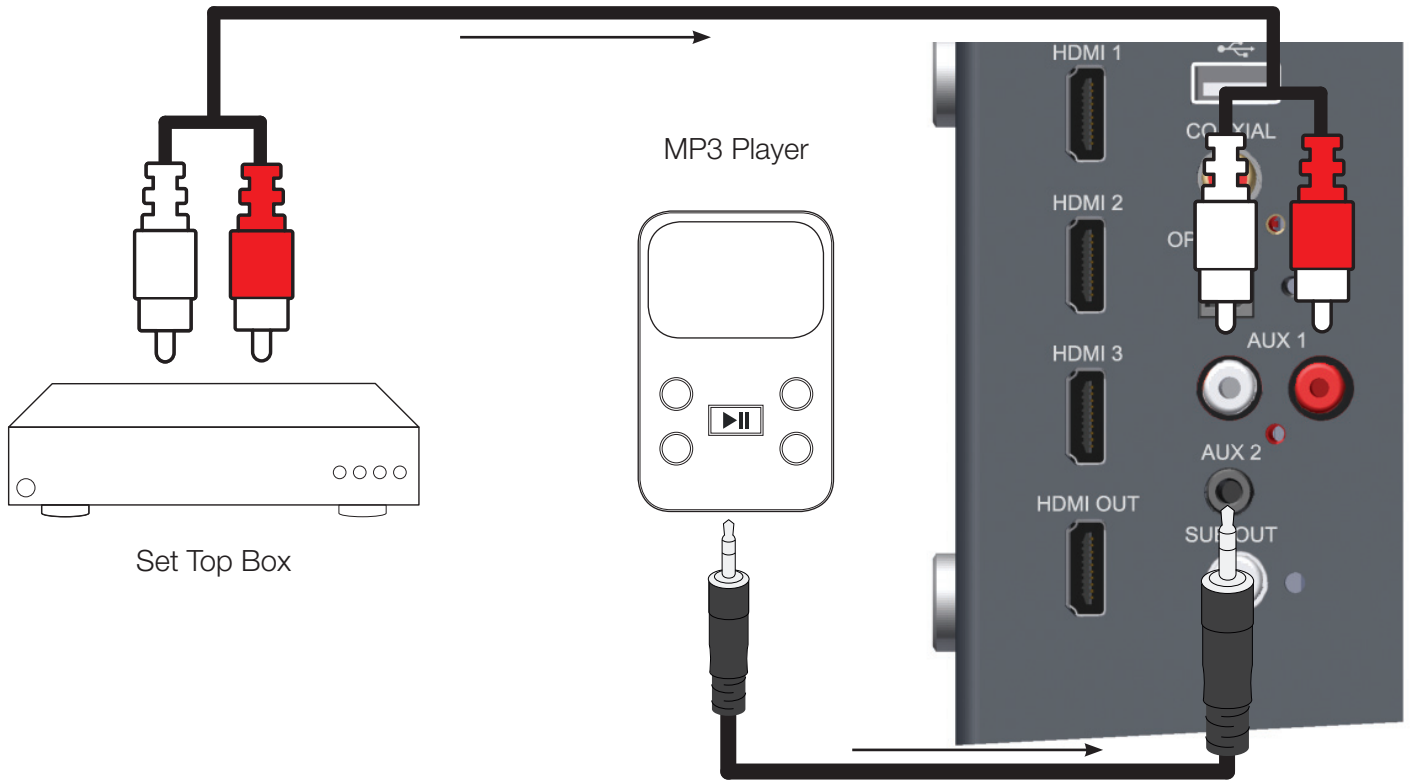

EN Subwoofer Output

FR Sortie de caisson de basse

IT Uscita subwoofer

DE Subwoofer-Ausgang

ES Salida del subwoofer

PT Saída de subwoofer

NL Subwoofer uitgang

中文 低音炮输出

RU Выход на сабвуфер

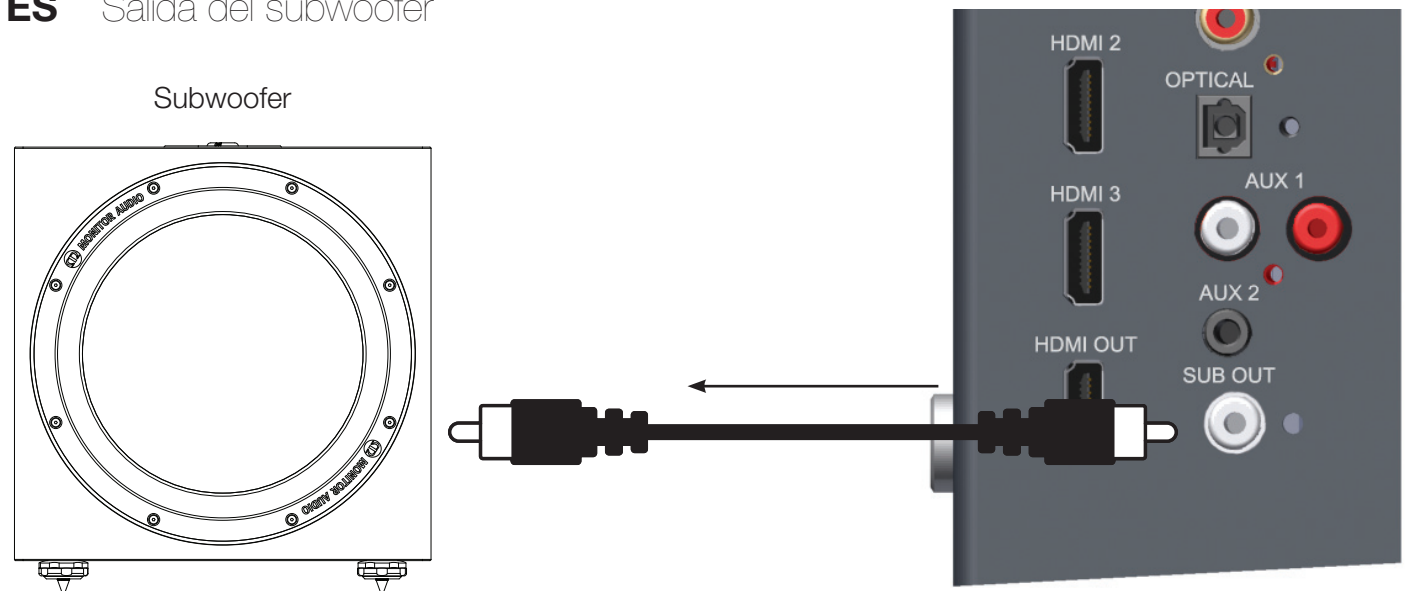

EN Connecting the Power
FR Branchement de l'alimentation
IT Connessione all'alimentazione
DE Netzanschluss
ES Conexión de la alimentación

PT Ligar a alimentação
NL Stroom aansluiten
中文 连接电源
RU Подключение питания

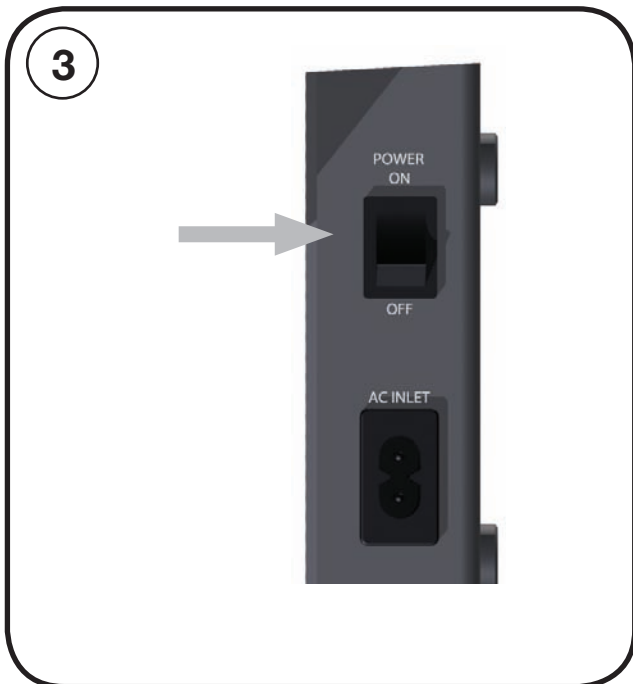
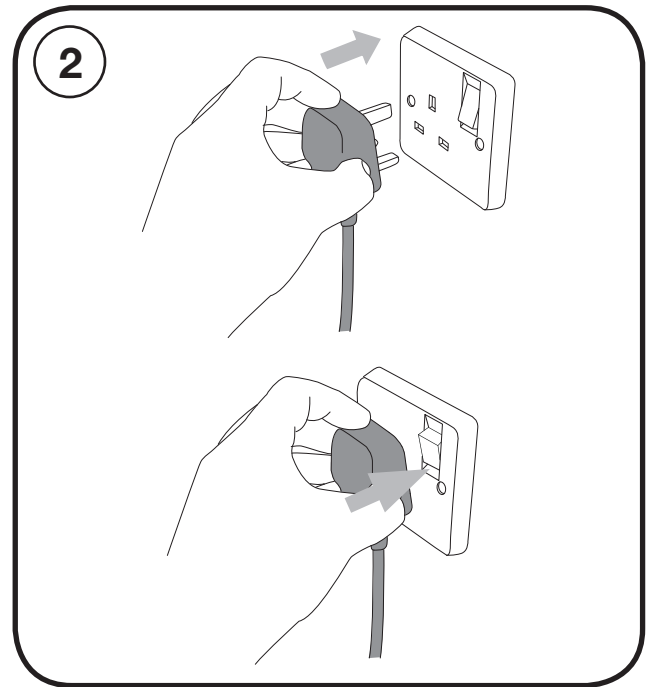
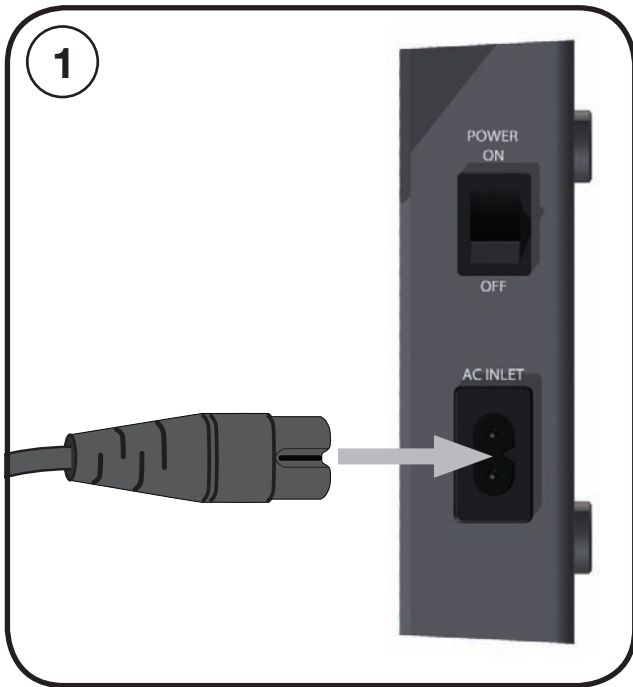

EN Turning On.
FR Allumage
IT Accensione
DE Einschalten
ES Encendido

PT Ligar.
NL Aanzetten.
中文 打开
RU Включение устройства

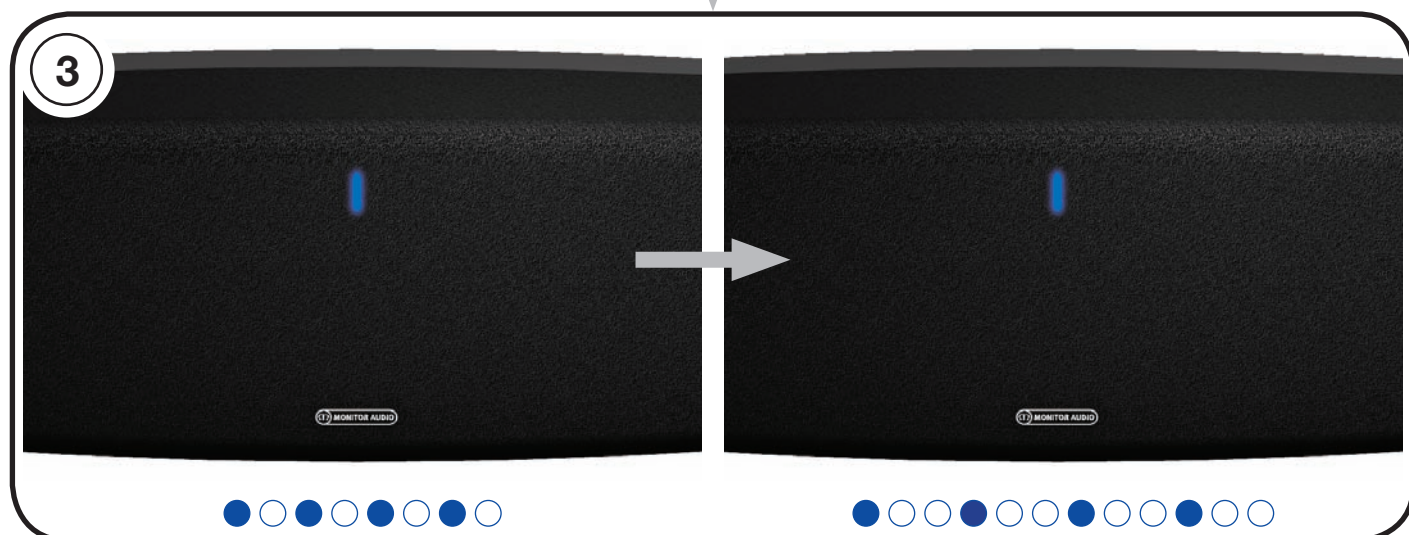
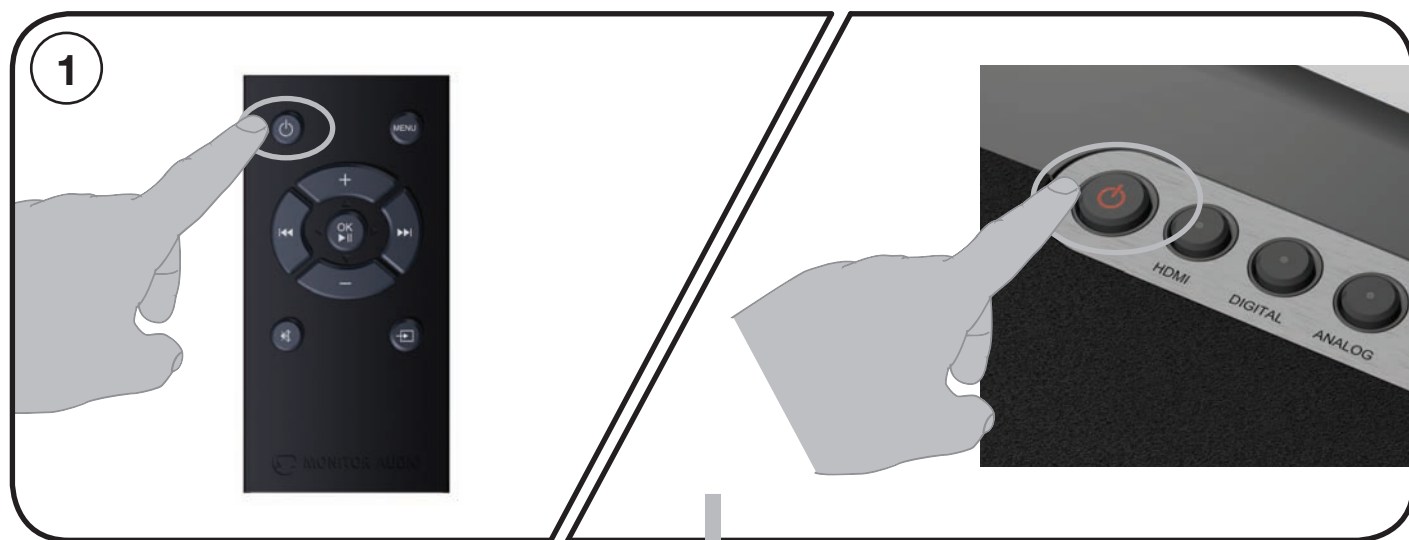

EN Connecting to the WiFi Network
FR Connexion au réseau WiFi
IT Connessione alla rete Wi-Fi
DE Verbindung mit dem WLAN-Netzwerk
ES Conexión a la red WiFi

PT Ligar à rede Wi-Fi
NL Aansluiten op het wifi-netwerk
中文 连接到无线网络
RU Подключение к беспроводной сети

WPS



WiFi

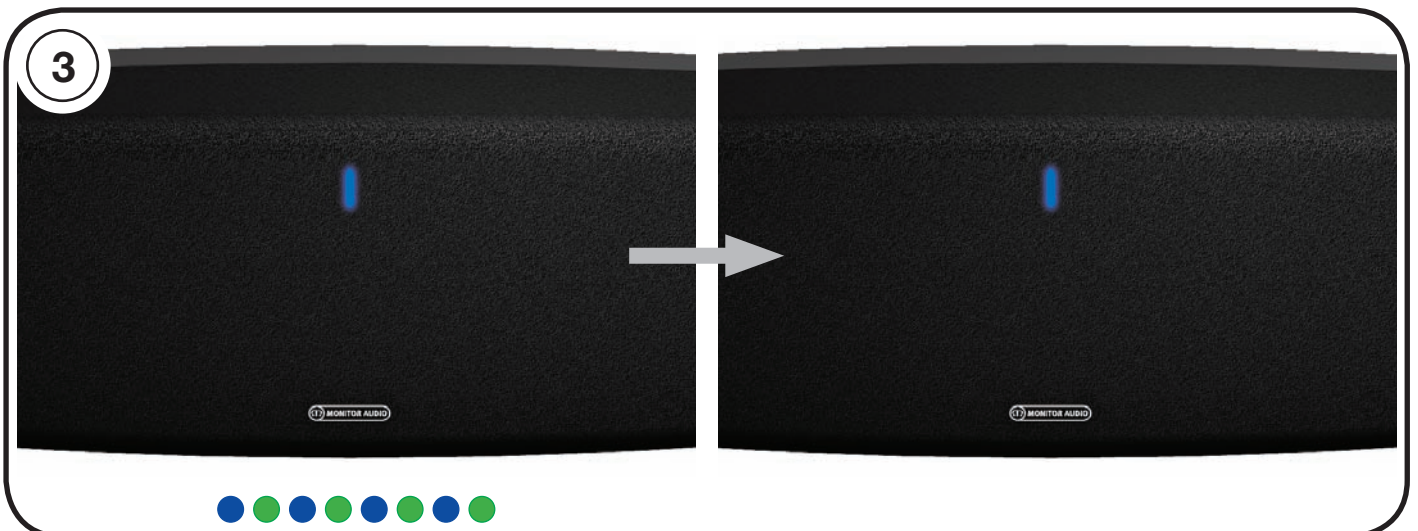
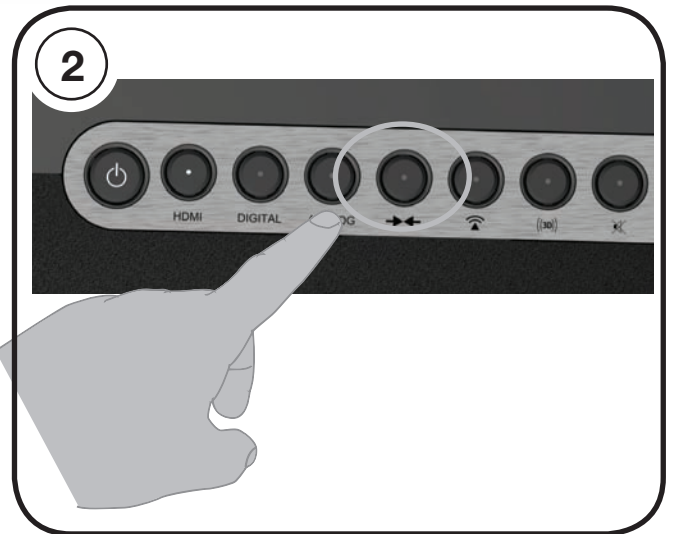
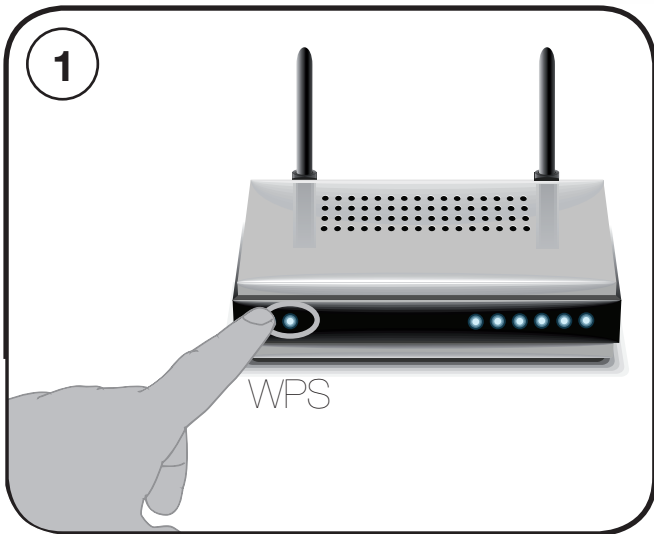



Monitor Audio Ltd.
24 Brook Road
Rayleigh, Essex
SS6 7XJ
England
Tel: +44 (0)1268 740580
Fax: +44 (0)1268 740589
Email: info@monitoraudio.co.uk
Web: www.monitoraudio.co.uk

**Designed and Engineered in the
United Kingdom, made in China**

Version 1. 2013