

TECSUN

TECSUN ELECTRONIC IND. LTD.

Address: Rm 11, 13/F, Block A, Hoi Luen Ind. Ctr.,
55 Hoi Yuen Road, Kwun Tong, Kowloon, Hong Kong.
E-mail: tecsun@on-nets.com
Website: www.tecsun.com.cn

TECSUN

PL-310ET

FM stereo / SW / MW / LW DSP RECEIVER

OPERATION MANUAL

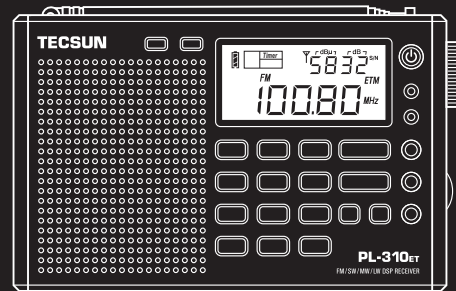

TECSUN ELECTRONIC IND. LTD.

TABLE OF CONTENTS

| | |
|---|----|
| CONTROL LOCATIONS | 2 |
| LCD DISPLAY | 4 |
| HOW TO TURN ON/OFF THE RADIO | 5 |
| TUNE INTO STATIONS | 6 |
| ● ETM (Easy tuning mode) | |
| ● Manual tuning | |
| ● Auto browse stations | |
| ● Direct keypad entry | |
| WORKING WITH STATION MEMORIES | 10 |
| ● Auto tuning storage (ATS) | |
| ● Storing station manually | |
| ● Semi-auto storing stations | |
| LISTENING TO STORED STATIONS | 11 |
| ● Manual memory tuning | |
| ● Auto browse memory | |
| ● Direct key in memory address | |
| DELETE MEMORY | 12 |
| ● Deleting a single memory manually | |
| ● Semi-auto delete memory | |
| ● Manual deletes all memory within the band | |
| SLEEP FUNCTION | 13 |
| CLOCK SETTING | 13 |
| WORKING WITH ALARM | 14 |
| ● How to set the alarm by buzzer | |
| ● How to set the alarm by radio | |
| ● How to activate / deactivate the alarm | |
| ● How to turn off when alarming | |
| SNOOZE FUNCTION | 15 |
| HOW TO CHANGE THE DISPLAY MODE | 16 |
| KEY-LOCK FUNCTION | 16 |
| WORKING WITH INTELLIGENT LIGHT | 16 |
| FM ST. (FM STEREO) | 17 |
| AM BW (BANDWIDTH) | 17 |
| SYSTEM SETTING | 18 |
| APPLYING INTELLIGENT CHARGING FUNCTION | 19 |
| HOW TO IMPROVE FM / SW RECEPTION | 20 |
| IMPORTANT MATTERS FOR USING BATTERIES | 20 |
| TROUBLE SHOOTING | 21 |
| "BEEPING (B)" SOUND VIA FUNCTIONS | 23 |
| SPECIFICATIONS | 25 |

CONTROL LOCATIONS

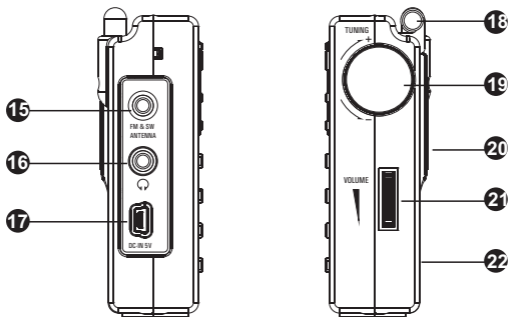
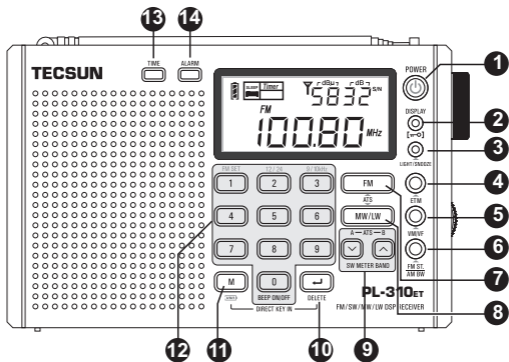

- 1 Power on/off
- 2 Display & Lock button
- 3 Light / Snooze button
- 4 Easy Tuning Mode (ETM)
- 5 VM / VF button
- 6 FM ST. / AM BW (Band width) button
- 7 FM / ATS button (FM band selector and Auto Tuning Storage)
- 8 MW / LW button (MW / LW band selector & Auto Tuning Storage)
- 9 SW/ ATS button (SW meter band selector & Auto Tuning Storage)
- 10 Enter / Delete button
- 11 Memory button
- 12 Numeric keypad
- 13 Time Set
- 14 Alarm Set
- 15 FM & SW Antenna Jack
- 16 Earphone Jack
- 17 USB 5V DC-IN Jack
- 18 FM & SW Telescopic Antenna
- 19 Multifunctional Tuning Knob
- 20 Back Stand
- 21 Volume Knob
- 22 Battery Compartment

LCD DISPLAY

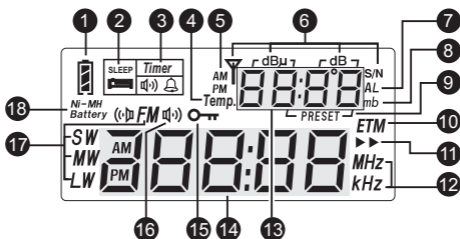

- | | |
|--|---|
| <p>1 Battery consumption indicator</p> <p>2 Sleep indicator</p> <p>3 Alarm indicator " ㊦ " alarm by radio " ㊧ " alarm by buzzer</p> <p>4 Temperature (Temp.)</p> <p>5 AM, PM indicator for 12-hour format clock</p> <p>6 Signal indicators dBu: signal strength unit dB : Signal to Noise Ratio (S/N) unit</p> <p>7 Alarm indicator</p> <p>8 Meter band indicator</p> <p>9 Preset memory address indicator</p> <p>10 ETM indicator</p> <p>11 Tuning speed: " >> " Slow Tuning " > " Fast Tuning</p> | <p>12 kHz: frequency unit for MW, LW & SW MHz: frequency unit for FM</p> <p>13 Digital number display (4 Digits) With radio off: local time, alarm time, temperature With radio on: local time, signal strength / SNR, alarm time, temperature, memory address, meter band.</p> <p>14 Master Digits With radio off: local time With radio on: frequency display, band display</p> <p>15 Key-lock indicator</p> <p>16 FM stereo status indicator</p> <p>17 Band indicator</p> <p>18 Ni-MH Battery Symbol</p> |
|--|---|

HOW TO TURN ON/OFF THE RADIO

1. Open the battery compartment located on the back of the radio; install 3 x AA alkaline batteries observing the battery polarity diagram. Close the battery door.

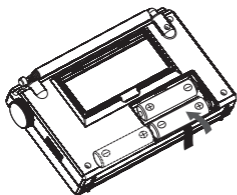

Installing batteries

2. Press the [POWER] button to turn on/off the radio.

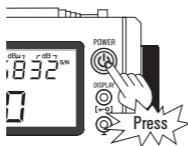

Note:

If the radio is unable to be turned on, please check if the batteries were installed correctly, or the battery capacity is sufficient and the lock function has not been turned on (press & hold the [] button to unlock.)

TUNE INTO STATIONS

Press the [POWER] button to turn on your radio, then select your desired band by pressing the [FM], [MW/LW], SW [∨] or [∧] button. In case of receiving FM/ SW broadcasting, fully extend the telescopic antenna for a better reception. When receiving MW (LW) broadcasting, please rotate the radio or change it's location to achieve optimum reception. Now, you can turn into your favorite stations with any of the below tuning methods:

METHOD 1:

ETM (EASY TUNING MODE)

ETM is a unique tuning method designed by Tecsun. It skillfully combines the reception circuitry & control procedure to pre-select the radio station and temporarily auto stores them into the ETM memory (not the regular 550 memories). This highly enhances the efficiency when tuning into radio stations.

Please follow below steps to tune into your preferred frequencies employing ETM:

1. Press the [ETM] button and "ETM" will appear on screen to enter Easy Tuning Mode.
2. Press & hold the [ETM] button until the frequency start running to auto scan and store stations into ETM memory, within the present band.
3. When the frequency stops running, turn the [TUNING] knob to select those stored stations.

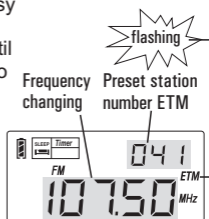

Notes:

While operating ETM to search for stations, a few stations might be missed if there is interference in the surrounding. In this case, you can simply key-in the frequency, then press the [ETM] button to manually store it into the ETM memory.

Tips:

FM station: When you are in a different city or country, you should perform the ETM function again in stead of using ATS function, because this will not delete any of the stations already stored within the memory.

MW station: It is recommendable to perform the ETM function during night time, because there are usually many stations starting broadcasting at night.

SW station: It is recommendable to perform the ETM function in the morning, afternoon as well as night time, because the transmitting signal of SW is very unstable and usually there are more stations that start broadcasting in the late afternoon.

METHOD 2: MANUAL TUNING

Frequency searching: Press the [VM/VF] button to switch into frequency mode, and then rotate the [TUNING] knob to select your desired station.

FAST/SLOW tuning is shown in the chart below for each band.

| step band | ► Slow tuning mode | ►► Fast tuning mode |
|--------------|--------------------|---------------------|
| | turning step | turning step |
| FM | 0.01 MHz | 0.1 MHz |
| MW | 1 kHz | 9 / 10 kHz |
| LW | 1 kHz | 9 kHz |
| SW | 1 kHz | 5 kHz |

Memory searching: Press the [VM/VF] button and “VM” will appear on screen to enter memory mode, and then rotate the [TUNING] knob to select those stored stations.

METHOD 3: AUTO BROWSE STATIONS

1. Turn on the radio and press the [VM/VF] button to switch into frequency mode.
2. Press & hold the [VM/VF] button until [▶▶] advancing to scan from one station to another, staying on each station for about 5 seconds.
3. To stop the auto browse function, simply press the [VM/VF] button.

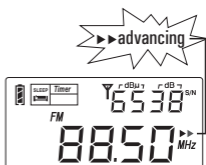

Auto browse station

Note:

While operating the “Auto-browse Station” function, you can press the [M] button anytime to store the station into memory, and the radio will keep on auto browsing the next available station.

METHOD 4: DIRECT KEYPAD ENTRY

To search for a frequency, turn on the radio and press the [VF] button to switch into frequency mode, press the numeric keys [0] - [9] to enter the station frequency directly.

To search for those stored stations, press the [VM/VF] button to switch into memory mode, then press the numeric keys [0] - [9] to enter the preset memory number directly.

Notes:

1. Ignore the decimal point for FM band when inputting the frequency numbers.
For example, FM 89.3 MHz, just enter 8 9 3.
2. If the entered frequency is not within the covering area, the display would display “Err” (error) symbol.

WORKING WITH STATION MEMORIES

There are in total 550 preset memories within the unit. 100 preset memories for each FM, MW, and LW band, and 250 for SW.

METHOD 1: Auto Tuning Storage (ATS)

FM ATS:

1. Fully extend the telescopic antenna and press the [FM] button to select FM band.
2. Press & hold the [FM] button until "PRESET" flashing and the frequency advancing; now the unit starts scanning and storing all available stations into the memories.

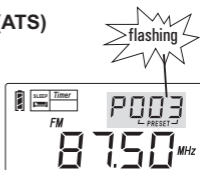

When the frequency stops advancing, it means the ATS operation is done completely. You can rotate the [TUNING] knob to search for those stored stations.

MW/LW ATS:

Press the [MW/LW] button to select MW/LW band, then follow step 2 of FM ATS.

SW ATS:

Fully extend the telescopic antenna and press the SW [∨] or [∧] button to select SW band. There are two modes for SW ATS tuning:

Mode A: Press & hold the [∨] button to ATS the stations within all meter bands

Mode B: Press & hold the [∧] button to ATS the stations within present meter band.

Notes:

1. During ATS process in FM, MW / LW or SW (mode A), pre-stored radio stations will be replaced automatically by the new searched stations.
2. With ATS in SW (mode B), those existing memories will not be replaced; all the newly found radio stations will be stored in the blank memory addresses.

- 3.If there is too many interference in your surrounding or many mirror/blank stations are being stored during ATS, you should contract the telescopic antenna (FM & SW) or rotate the radio for better reception (MW & LW).

METHOD 2: STORING STATION MANUALLY

- 1.Select band and tune to your desired station.
- 2.Press the [M] button with "PRESET" flashing.
- 3.Press the [M] button again to store the station into memory.
- 4.You can also wait for 3 seconds to auto store the station into memory.

METHOD 3: SEMI-AUTO STORING STATIONS

While operating the "Auto Browse Station" function, you can simply press on the [MEMORY] button to store the station into memory to avoid storing unwanted stations and interfering signals.

- 1.Press the [VM/VF] button to switch into frequency mode.
- 2.Press & hold the [VM/VF] button with "▶▶" advancing to auto browse from one station to another.
- 3.While tuning to your desired station, press the [M] button followed by "PRESET" display to directly store the station into the next available memory. The unit will keep on browsing until you deactivate it by pressing on the [VM/VF] button again.

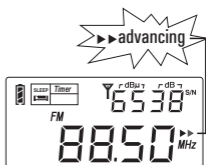

Auto browse station

LISTENING TO STORED STATIONS

METHOD 1: MANUAL MEMORY TUNING

Press the [VM/VF] button and “PRESET” will appear on screen to enter memory mode, then rotate the [TUNING] knob to tune into the stored station one by one.

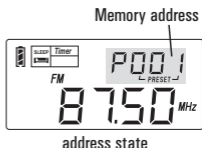

METHOD 2: AUTO BROWSE MEMORY

1. Press the [VM/VF] button and “PRESET” will appear on screen to enter memory mode.
2. Press & hold the [VM] button until “PRESET” flashing to auto scan from one memory to another, staying on each station for about 5 seconds.
3. To stop auto search memory, simply press the [VM/VF] button.

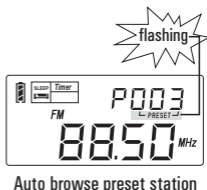

METHOD 3: DIRECT KEY IN MEMORY ADDRESS

1. Press the [VM] button to enter the memory mode.
2. Press the numeric keys [0] - [9] to enter the memory address directly, and then press the  button to confirm.

Note: If the display shows “ - - - - ” symbol after entering the number, it means the entered memory address does not exist.

DELETE MEMORY

Press the [VM/VF] button, then you will see the “Memory address” and “VM” flashing on the upper right corner of the display to enter the memory mode. Then follow one of the below methods to delete those unwanted stations:

METHOD 1. DELETING A SINGLE MEMORY MANUALLY

Rotate the [TUNING] knob to select the memory that you want to delete, press & hold the [DELETE] button until “dEL” and “memory address” flashing; then immediately press the [DELETE] button to remove the unwanted memory address.

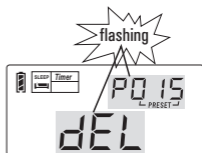

Delete a single station

METHOD 2: SEMI-AUTO DELETE MEMORY

Press and hold the [VM/VF] button until “PRESET” flashing to auto browse those stored stations, press the [DELETE] button at anytime to direct delete the unwanted station; the radio will keep on auto browsing the next available station until you press any other button to stop this function.

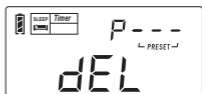

Delete memory

METHOD 3: MANUAL DELETES ALL MEMORY WITHIN THE BAND

Press & hold the [DELETE] button for 3 seconds and notices “ALL” appears on the upper right corner of the display, then press the [DELETE] button to delete all memory within the selected band.

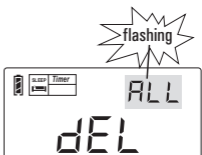

SLEEP FUNCTION

1. Press & hold the [POWER] button until “ SLEEP ” and “On or 1~120” shows on the display.
2. Rotate the [TUNING] knob immediately to select sleep timer from 1 ~ 120 minutes or select permanently “ On ”, then wait until the radio auto turn on to confirm the setting.

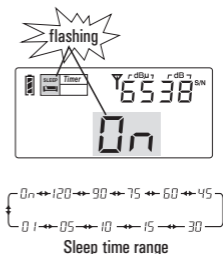

CLOCK SETTING

1. Press & hold the [TIME] button until hours flashing, then rotate the [TUNING] knob to adjust the hour.
2. Press the [TIME] button, then rotate the [TUNING] knob to adjust the minutes while minutes is flashing.
3. Press the [TIME] button to confirm the setting.



※ If the [TIME] button has not been pressed again within 3 seconds, the unit will automatically confirm the setting.

Note: You can also direct key-in the number to set the clock after pressing & holding the [TIME] button.

Example: To set the clock to 6:35, press the numeric key to enter ; then you will hear a prolonged beep (B) sound suggesting that the time has been set.

WORKING WITH ALARM

It is recommended to set the alarm by buzzer if you are not familiar with the local radio frequency and air time.

HOW TO SET THE ALARM BY BUZZER

1. Press & hold the [ALARM] button until hours flashing in the upper right corner, then rotate the [TUNING] knob to adjust the hour.
2. Press the [ALARM] button, then rotate the [TUNING] knob to adjust the minute while minutes flashing.
3. Press the [ALARM] button again to confirm the setting.

※ If the [ALARM] button has not been pressed again within 3 seconds, the unit will automatically confirm the alarm setting.

HOW TO SET THE ALARM BY RADIO

First preset the alarm station following below steps:

1. Turn on the radio, then tune into your favorite station for alarm by radio and adjust your desired alarm volume level.
2. Press the [M] button with "PERSET" flashing,
3. Press the [ALARM] button immediately and notice "🔊" shows on the display to confirm the preset alarm station.

Then set the alarm time:

1. Press & hold the [ALARM] button until hours flashing in the upper right corner, then rotate the [TUNING] knob to adjust the hours.
2. Press the [ALARM] button, then rotate the [TUNING] knob to adjust the minute while minutes flashing.
3. Press the [ALARM] button again and notice "30" shows on display, then rotate the [TUNING] knob to select 1 ~ 90 minutes to set the auto alarm off timer.
4. Press the [ALARM] button again to confirm.







Auto sleep timer

※ If the [ALARM] button has not been pressed again within 3 seconds; the unit will automatically confirm the setting.

The radio will turn on automatically playing the preset station when it reaches the alarm time. It will auto turn off as well when it reaches the preset alarm off timer.

HOW TO ACTIVATE / DEACTIVATE THE ALARM

You can press the [ALARM] button repeatedly to activate/deactivate the alarm by buzzer / radio respectively.

- If “” shows on the display, it means the alarm by buzzer is turned on.
- If “” shows on the display, it means the alarm by radio is turned on.
- If “” / “” does not show on the display, it means the alarm by buzzer / radio is turned off.

HOW TO TURN OFF WHEN ALARMING

Buzzer alarm: Press the [POWER] button to turn off the alarm.

Radio alarm: Press the [POWER] button once to continue listening to the radio, press twice to turn off the station alarm.

Note: If the preset alarm is activated when you are listening to the radio, it will auto switch to the preset radio station.

SNOOZE FUNCTION

When the preset alarm is activated, you can press the [LIGHT / SNOOZE] to temporarily turn off the alarm, the unit will start alarming again 5 minutes later.

HOW TO CHANGE THE DISPLAY MODE

With radio OFF: Repeat pressing the [DISPLAY] button to view temperature, home/world time or alarm time display.

With radio ON: Press the [DISPLAY] button to view home time, world time, alarm time, temperature or signal strength showing on the upper right corner of the display.

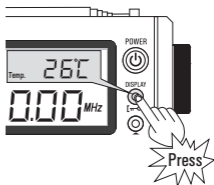

KEY-LOCK FUNCTION

Press & hold the [π-O] button until “O-π” symbol appears on the display to activate the key lock function.

Press & hold it again until “O-π” symbol disappears to deactivate the locking function.

WORKING WITH INTELLIGENT LIGHT

This radio has an intelligent lighting function with which the backlight would be on for 5 seconds when operating any keys or knobs.

You can use the following methods to turn on / off the backlight:

TEMPORARY ILLUMINATION:

Press the [LIGHT/SNOOZE] button with a “B” sound to illuminate the LCD for 5 seconds.

PERMANENT ILLUMINATION:

Press & hold the [LIGHT/SNOOZE] button until a prolonged double beep (BB) sound heard for permanently illumination. Press it again with a double beep (BB) sound to turn off the backlight.

Notes:

1. When the unit is powered by the batteries, please try to avoid setting the backlight to permanent illumination to reduce power consumption.
2. When the unit is turned off, the permanent illumination function will be turned off automatically as well.

FM ST. (FM STEREO)

While listening to FM stereo stations, press the [FM ST.] button and notice “ (◀▶) ” appears in the display to activate the stereo listening. If the received FM broadcast signal is too weak, it is recommendable to turn off the stereo function by pressing the [FM ST.] button again with “ (◀▶) ” disappears.

Note: The stereo function will not be activated if the FM station is not stereo broadcasting.

AM BW (BANDWIDTH)

Repeat pressing the [AM BW] button to select your desired 6, 4, 3, 2, 1 kHz bandwidth.

Wide band: It has better audio fidelity when receiving strong signals or local stations.

Narrow band: It is suitable to receive weak & long distant stations as narrow band is able to limit the interference from adjacent strong signal and reduce background noise.

SYSTEM SETTING

SETTING FM FREQUENCY RANGE:

In radio off mode, press & hold the [FM SET] button until 87.5-108MHz, 64-108MHz, 76-108MHz, or 87-108MHz appears in the display. Quickly keep pressing on the [FM SET] button to select a suitable frequency range for your local FM.

SETTING MW (AM) TUNING STEP:

With radio off, press & hold [9/10 kHz] button until "9kHz" or "10kHz" appears on the display to select your desired AM tuning step



TEMPERATURE:

When the AM tuning step is 10 kHz, the temperature displays will auto switch to Fahrenheit (°F). When the AM tuning step is 9 kHz, the temperature display will auto switch to Centigrade (°C).

TURN ON/OFF THE LW:

With radio off, press & hold the [MW/LW] button until "LW ON" or "LW OFF" appears on the display to turn ON or OFF the LW respectively.

TURN ON/OFF THE CHARGING FUNCTION & EXCHANGE THE BATTERY CONSUMPTION DISPLAY:

With radio off, press & hold the [] key until " [CHRG ON] " & "Ni-MH " show on the display to activate the consumption display of rechargeable batteries and the built-in charging system. Press & hold the [] key until " [CHRG OFF] " showing and "Ni-MH " disappears to activate the consumption display of regular batteries and turn off the built-in charging function.

Note: The default setting of this radio is to use regular batteries for power supply. In case of using rechargeable batteries, you should switch the radio system to rechargeable batteries mode in order to show the correct power capacity.

TURN ON/OFF THE "Beep (B)" SOUND:

With radio off, press & hold the [BEEP ON/OFF] button until "ON" or "OFF" appears in the display to activate or deactivate the "Beep (B)" sound respectively.

INTELLIGENT CHARGING FUNCTION

With radio off, install 3 x UM3 (AA) rechargeable batteries & then press & hold the [] key until "CHRG" and "Ni-MH" displaying to activate the built-in charging function.

Use the 5V external adaptor with USB plug to connect with the radio. The symbol "  " will advance from the bottom to the top during power charging. It stops when the batteries are fully charged.

Connect 5V external adaptor with USB plug

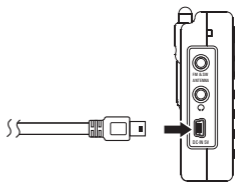

Notes:

1. Insist to use up all power of the rechargeable batteries before charging again. This could extend the life time of the battery and keep it in good conditions.
2. Three batteries should be used as a group and do not apply them for other usage. Also do not mix the batteries with different power capacity.
3. Do not charge any non-rechargeable batteries in the radio, this will cause a hazard or damage to your radio.

HOW TO IMPROVE FM / SW RECEPTION

Plug in the external wire antenna to the [FM & SW] antenna jack of this radio, and then hang its end outside the window for better reception of FM and SW.

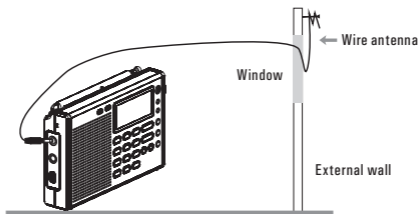

Caution: Do not install any external antenna at the area with thunder & lightning!

IMPORTANT MATTERS FOR USING BATTERIES

1. If no battery has been installed for a long time, the clock of the radio will stop to work. However, pre-stored frequencies are still kept. The clock will work again after new batteries are re-installed.
2. When the battery power is low, the "  " symbol on the display will flash to alert you to change to new batteries. It will turn off automatically when the power is gone.
3. Mixing the used & new batteries may cause damage to the radio and also display the power capacity incorrectly.
4. In case of the radio will not be used for a long period, take out the batteries to prevent liquid leakage that may damage the radio.

TROUBLE SHOOTING

| QUESTIONS | ANSWERS | SOLUTIONS |
|---|--|---|
| Not able to turn on the radio. | <ul style="list-style-type: none"> -Batteries have no power. -Might installed batteries incorrectly. -Power button is locked. | <ul style="list-style-type: none"> -Replace to new batteries. -Re-install all batteries according to "+" or "-" sign. -Press the [] button to unlocked. |
| Radio auto turns off while listening. | <ul style="list-style-type: none"> -Batteries have no power. -Sleep timer is activated. | <ul style="list-style-type: none"> -Replace all the batteries. -Turn on the radio again. |
| <ul style="list-style-type: none"> -Some station is not being stored using ATS. -Some station is being stored with noise using ATS. | <ul style="list-style-type: none"> -Frequency of stations is too weak. -There is interference nearby. | <ul style="list-style-type: none"> -Search the stations manually. -Low down the antenna or move to another location. |
| Only limited FM stations can be received in Japan. | FM frequency is 76~90 MHz for Japan. | Turn off the radio, repeat press & hold the [FM SET] button to select FM frequency range. |
| Poor AM reception in USA. | -USA uses 10kHz tuning step for AM. | Turn off the radio, repeat press & hold the [9/10kHz] button to select 10kHz. |

| QUESTIONS | ANSWERS | SOLUTIONS |
|--|--|---|
| <p>When the alarm activated (alarm by radio), there is only noise with the broadcast</p> | <p>-Did not set the proper radio station for the alarm</p> <p>-Or there are no broadcasting at that radio station</p> <p>-Or you have travelled to other city where does not have a radio station for your preset frequency.</p> | <p>-Preset your alarm station properly (see the above setting)</p> <p>-Make sure it has radio broadcast in your location.</p> <p>-Or set the alarm by buzzer.</p> |
| <p>radio malfunction</p> | <p>This may be caused by interference, and the computer microchip does not function properly.</p> | <p>Remove the battery, then you can reload. If it is still not able to work, please contact your nearest dealer for customer service.</p> |

"BEEPING (B)" SOUND VIA FUNCTIONS

| Function | Button | Status | Sound | Display |
|---------------------------|---|---------------------------------|-------|---|
| Radio on or off | POWER | Radio on | B | |
| | | Radio off | BB | "OFF" displays |
| Adjust auto-off time | POWER & TUNING KNOB | Rotate at 30, 60, 90, 120 mins. | B | Display auto turn off timer |
| | | Radio permanently | BB | "ON" displays |
| Lock |  | Lock | B | "ON" displays |
| | | Unlock | BB | "ON" disappears |
| ETM | ETM | ETM On | B | "ETM" displays |
| VF | VM/VF | Frequency mode | BB | Radio freq. numbers flashing |
| VM | VM/VF | Memory mode | B | "PRESET" displays |
| Auto browsing (Scanning) | VM/VF | Frequency mode | B | Radio freq. running |
| | VM/VF | Memory mode | B | Memory address running |
| FM | FM | FM | B | "FM" displays |
| MW (AM) or LW | MW/LW | MW | BB | "MW" displays |
| | | LW | B- | "LW" displays |
| SW BAND METER BAND | ∨ or ^ | SW | B | SW frequency displays |
| | | METER BAND | B | Meter band shows on the right corner of display |
| ATS (Auto Tuning Storage) | FM MW/LW SW (∨ or ^) | ATS on | B | Freq. & memory address are running |
| | | ATS off | B- | Display 01 memory address and Frequency |
| Store memory | MEMORY | On | B | Memory address flashing on the top right corner |
| | | Confirmed / Auto confirm | B- | Stopped |
| Delete memory | DELETE | Delete single memory | B | Memory address and "dEL" are flashing |
| | | Delete all memory | BB | "ALL" & "dEL" are flashing |
| | | Confirmed | B- | Back to Freq. display |

| Function | Button | Status | Sound | Display |
|------------------------------|---|----------------------------|------------|---|
| Backlight | LIGHT/ SNOOZE | Illuminate short time | B | Backlight on for 5 seconds |
| | | Turn off | BB | Backlight off |
| Snooze | LIGHT/ SNOOZE | Temporary off | B | "🔊" or "🔔" and the auto turn-on time are flashing |
| Time setting | TIME | Hour setting | B | "hour" flashing |
| | | Minute setting | BB | "minute" flashing |
| | | Confirm or Auto confirm | B.. | Flashing stop |
| Auto radio on / off function | ALARM | Hour setting | B | "hours" flashing |
| | | Minute setting | BB | "minutes" flashing |
| | | Adjust the length of alarm | BB | 1 ~ 90 minutes display, "🔊" and "🔔" are flashing |
| | | confirmed | B.. | Display time |
| | | Select alarm by radio | B | "🔊" displays |
| | | Select alarm by buzzer | BB | "🔔" displays |
| | | Select alarm off | B.. (long) | "🔊" and "🔔" disappear |
| In/out SW meter band | TUNING | Inside SW meter band | B | Meter band appears on the top right corner |
| | | Out of SW meter band | B | Meter band disappears |
| FM freq. range | FM SET | Select FM freq. | B | 87.5-108MHz, 64-108MHz, 76-108MHz or 87-108MHz |
| MW(AM) STEP | 9/10kHz | Select 9kHz step | B | "9kHz" and "°C" in the display |
| | | Select 10kHz step | BB | "10kHz" and "°F" in the display |
| Charge on/off |  | On | B | "CHARGE" & "Ni-MH Battery" in display |
| | | Off | BB | "CHARGE OFF" in display & "Ni-MH Battery" disappeared |
| "Bi" sound on/off | BEEP ON/OFF | On | B | "ON" displays |
| | | Off | BB | "OFF" displays |
| LW on/off | MW/LW | On | B | "LW ON" displays |
| | | Off | BB | "LW OFF" displays |

SPECIFICATIONS

| | |
|---|-------------------------------|
| 1. Frequency range | |
| FM | 87~108 MHz |
| Russia | 64~108MHz |
| Japan | 76~108 MHz |
| EU, USA | 87.5~108 MHz |
| MW | 522~1620 kHz |
| USA | 520~1710 kHz |
| LW | 153~513 kHz |
| SW | 2300~21950 kHz |
| 2. Sensitivity | |
| FM (S/N=30dB) | Less than 3 μ V |
| MW (S/N=26dB) | Less than 1mV/m |
| LW (S/N=26dB) | Less than 10mV/m |
| SW (S/N=26dB) | Less than 20 μ V |
| 3. Selectivity | |
| FM | > 60 dB (\pm 150kHz) |
| MW | > 60 dB (BW=3kHz, \pm 9kHz) |
| LW | > 60 dB (BW=3kHz, \pm 9kHz) |
| SW | > 60 dB (BW=3kHz, \pm 5kHz) |
| 4. FM Stereo crosstalk: Less than 35 dB | |
| 5. Memory: 550 | |
| 6. Output (Distortion 10%): 180 mW | |
| 7. Power : UM3 or AA X 3 USB 5V DC | |

8. Speaker: ϕ 57mm, 500mW/16Ohm

9. Earphone Jack: ϕ 3.5mm, 8~32 Ohm, Stereo type

10. Dimensions Approx.: 141(W) X 87(H) X 30(D) mm

11. Weight: 190g (Batteries not included)

