



**DISTRIBUTORI
OLEODINAMICI**

WMM25

MANUALLY OPERATED
DIRECTIONAL CONTROL VALVES

WMM25 SERIES MANUALLY OPERATED DIRECTIONAL CONTROL VALVES ARE DIRECT TYPE DIRECTIONAL SPOOL VALVES. THESE VALVES ARE USED TO THE START, STOP AND DIRECTION OF FLOW. THIS SERIES WITH DETENT OR RETURN SPRING ARE AVAILABLE.

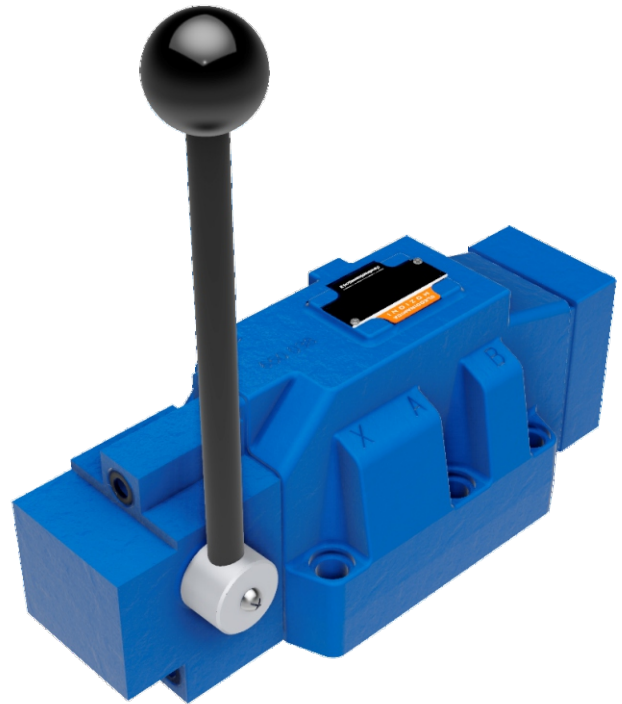

TECHNICAL DATA

SIZE		25
MAX. FLOW RATE (L/MIN)		450
OPERATING PRESSURE (MPA)	A, B, P PORTS	31.5
	T PORT	25
WEIGHT (KG)		39.2
VALVE BODY (MATERIAL)		CASTING PHOSPHATING SURFACE



CHARACTERISTIC CURVES

$\Delta P-Q$ CHARACTERISTIC CURVES - SPOOL TYPE E, R, W

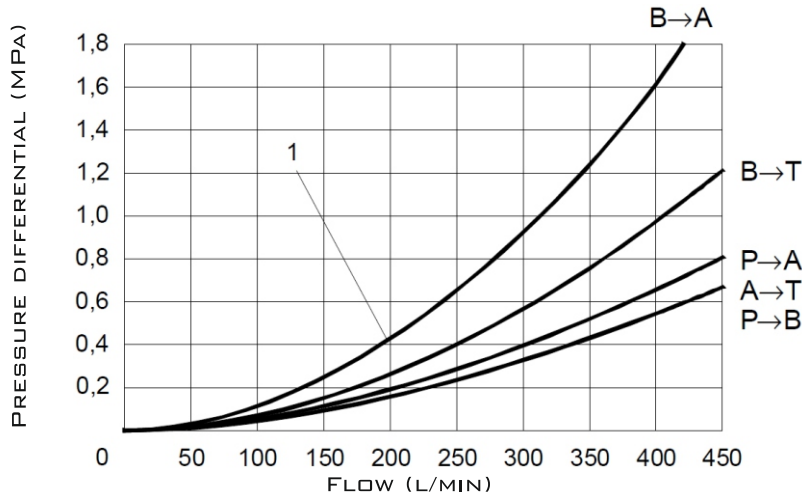

1) ONLY APPLICABLE FOR SPOOL TYPE "R"

$\Delta P-Q$ CHARACTERISTIC CURVES - SPOOL TYPE G, T

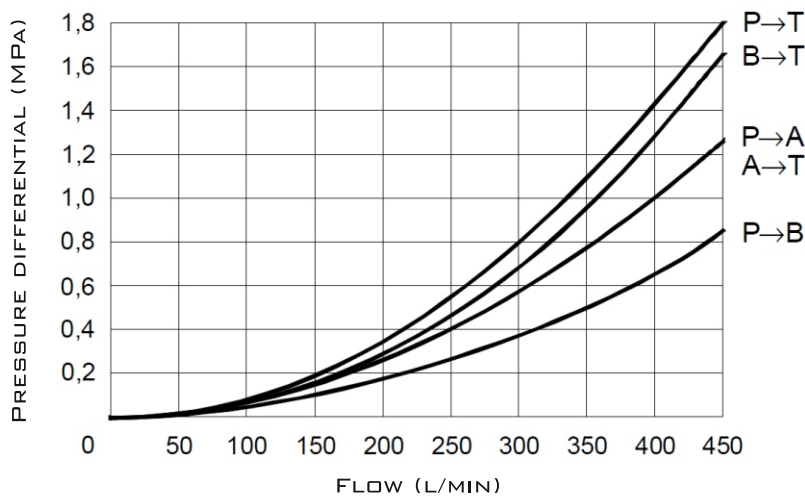

$\Delta P-Q$ CHARACTERISTIC CURVES - SPOOL TYPE S, F, H, J, L, M, Q, U, V, W, C, D, K, Z

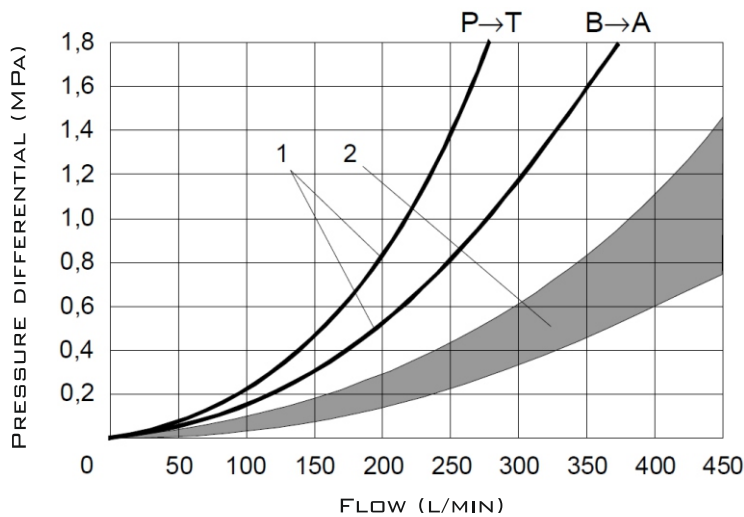

1) ONLY APPLICABLE FOR SPOOL TYPE "S"
2) NOT APPLICABLE FOR SPOOL TYPE "S"



DISTRIBUTORI
OLEODINAMICI

WMM25

MANUALLY OPERATED
DIRECTIONAL CONTROL VALVES

SPOOL SYMBOLS

2-POSITION VALVES

3-POSITION VALVES

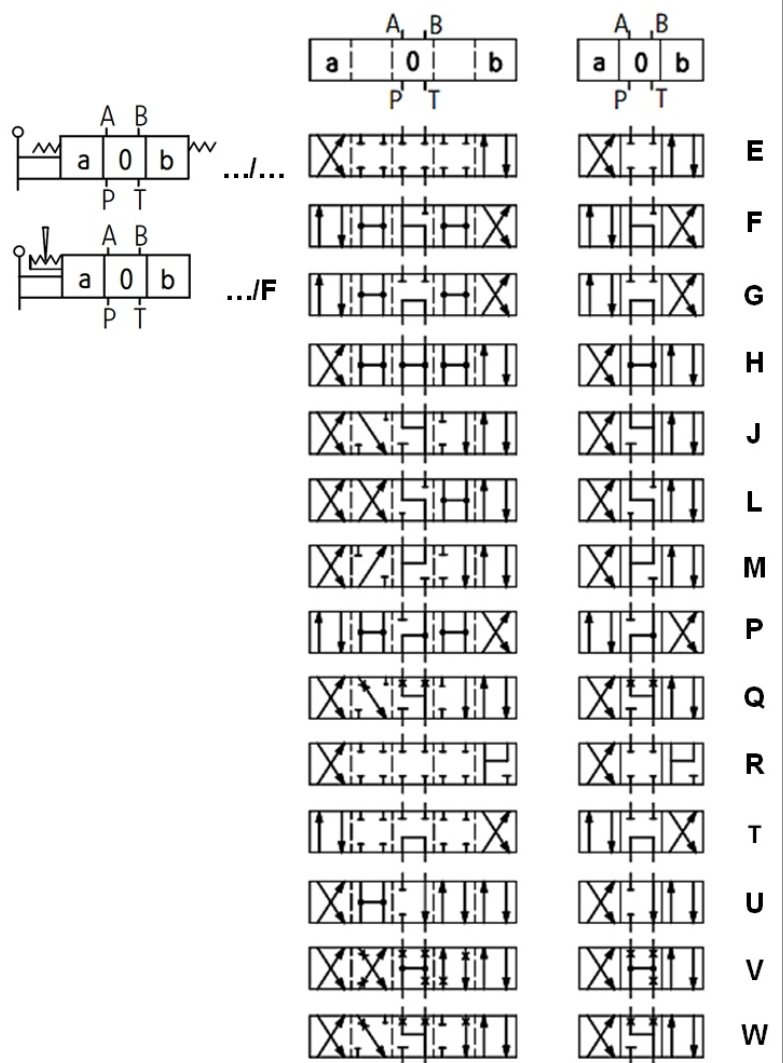
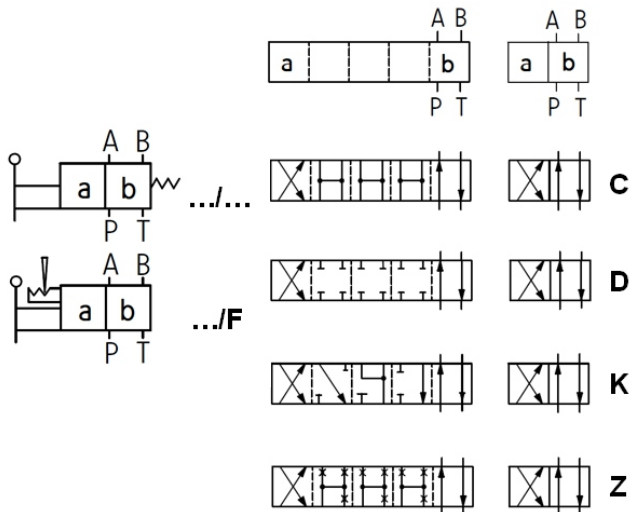

SEE ALSO:
WMM6, WMM10,
WMM16

SUBPLATE INSTALLATION DIMENSIONS

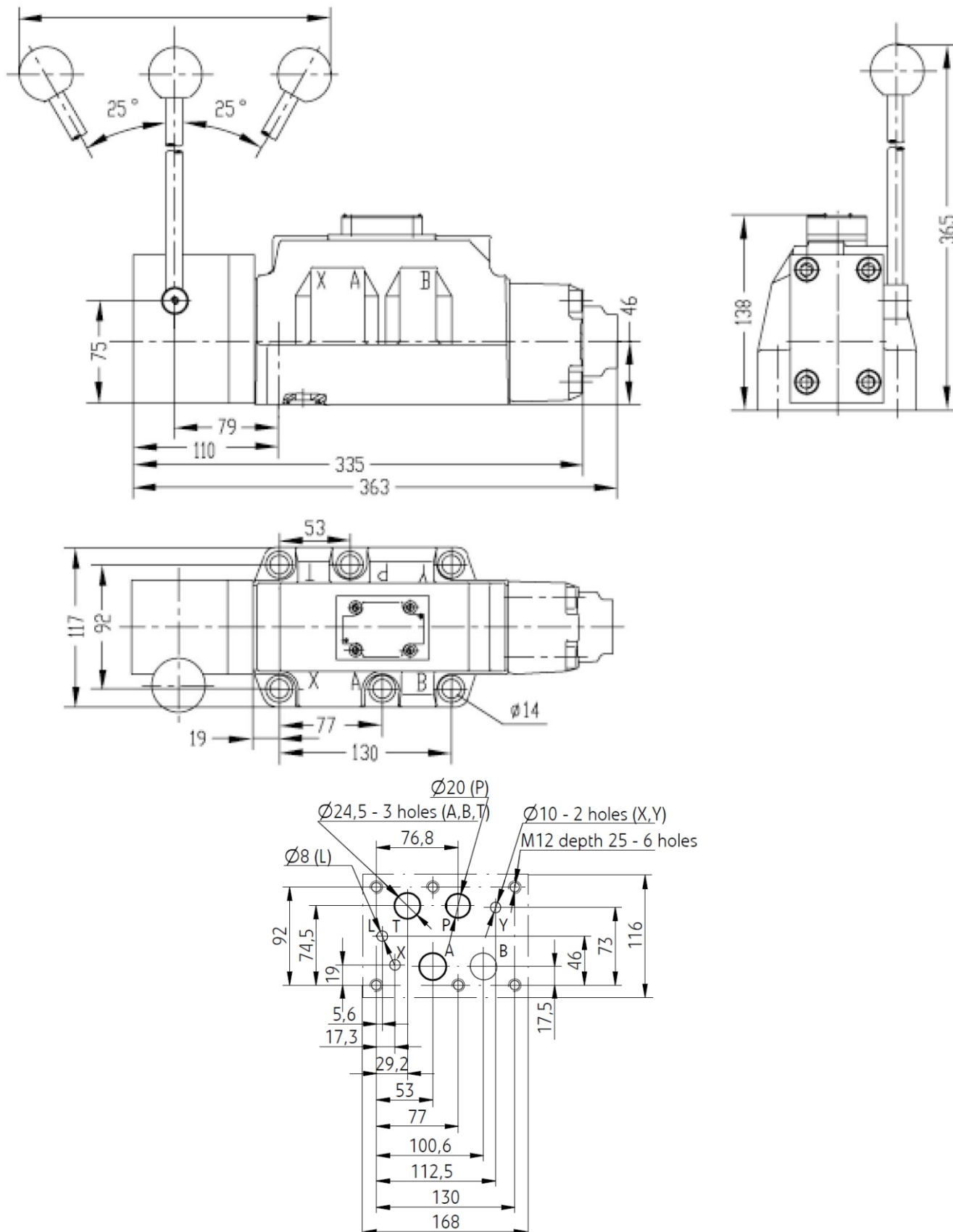



DISTRIBUTORI
OLEODINAMICI

WMM25

MANUALLY OPERATED
DIRECTIONAL CONTROL VALVES

ORDER CODE

		WMM	25							
--	--	-----	----	--	--	--	--	--	--	--

H=35MPA

3=3-WAY
4=4-WAY

25=25 SIZE

SPOOL TYPE

10=10 SERIES
50=50 SERIES

NO CODE=SPRING RETURN WITHOUT DETENT
F=DETENT WITHOUT SPRING RETURN

NO CODE=HANDLE
ON SIDE OF PORT A
L=HANDLE
ON SIDE OF PORT B

NO CODE=MINERAL SUBSTANCE
HYDRAULIC OIL
V=PHOSPHATE EATER
HYDRAULIC OIL

NO CODE=WITHOUT THROTTLE INSERT
B0.8=THROTTLE 0.8 MM
B1.0=THROTTLE 1.0 MM
B1.2=THROTTLE 1.2 MM