

Ventose speciali
con supporti a richiesta

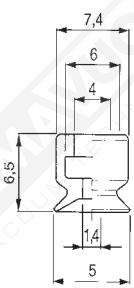

art. VSP 5

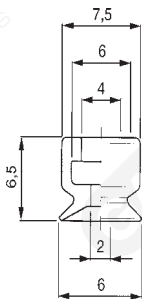

art. VSP 6

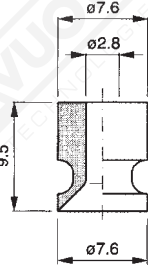

art. VSP 7

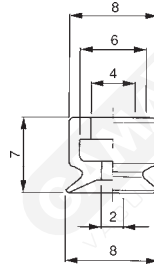

art. VSP 8

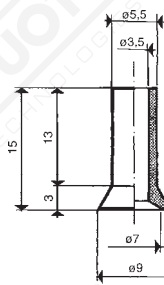

art. VSP 9

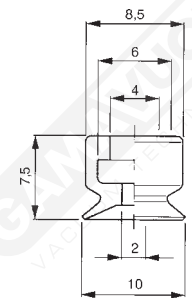

art. VSP 10

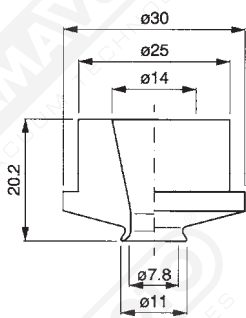

art. VSP 11

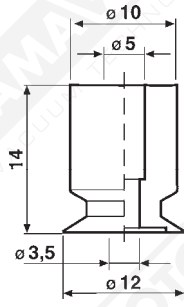

art. VSP 12

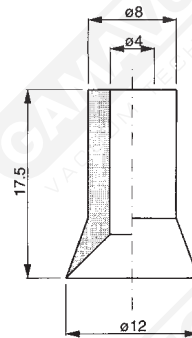

art. VSP 12/1

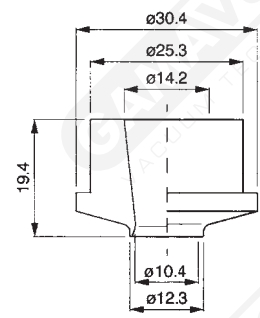

art. VSP 12/2

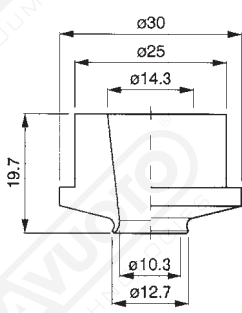

art. VSP 12/3

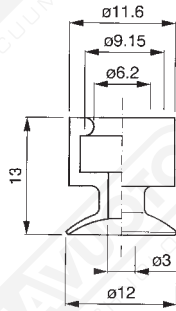

art. VSP 12/4

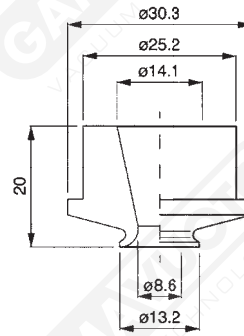

art. VSP 13/1

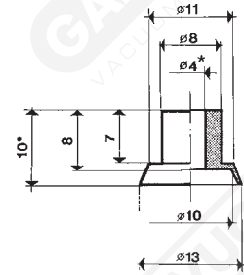

ART. VSP 13/41 * = 4 • 11
ART. VSP 13/4 * = 4
ART. VSP 13/2 * = 2

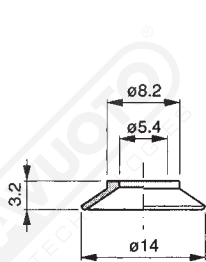

art. VSP 14

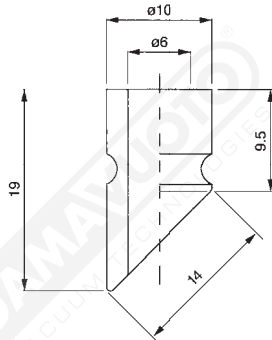

art. VSP 14/1

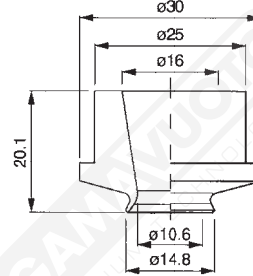

art. VSP 14/2

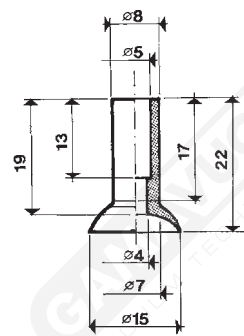

art. VSP 15

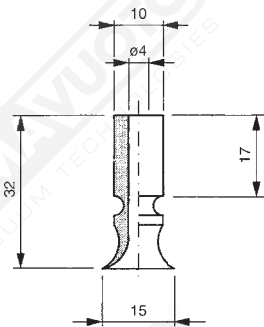

art. VSP 15/1

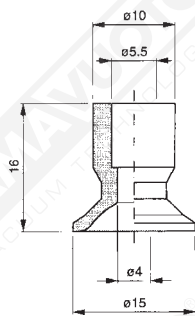

art. VSP 15/2

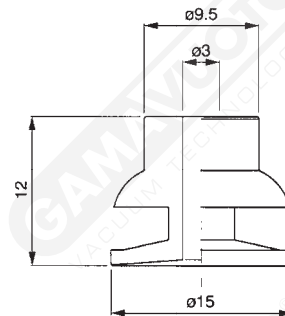

art. VSP 15/3

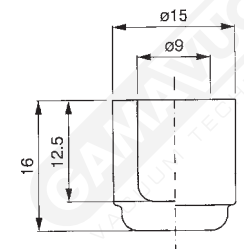

art. VSP 15/4

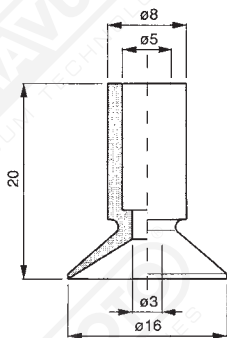

art. VSP 16

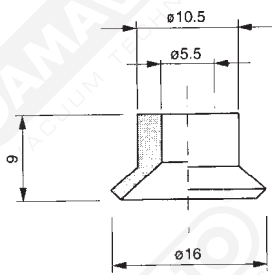

art. VSP 16/1

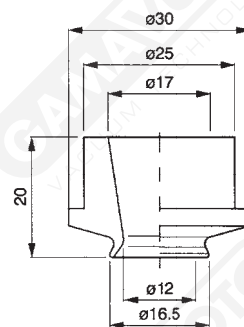

art. VSP 16/2

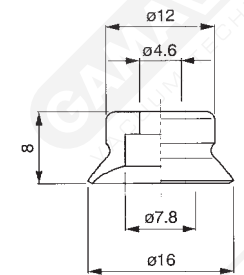

art. VSP 16/3

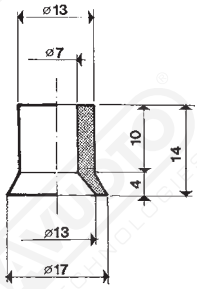

art. VSP 17

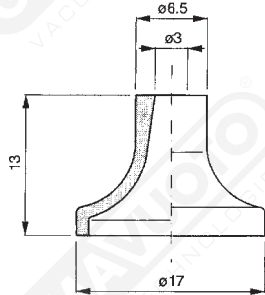

art. VSP 17/1

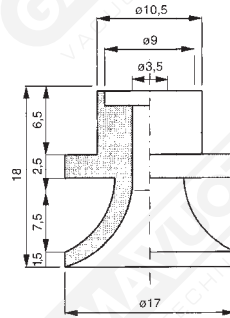

art. VSP 17/2

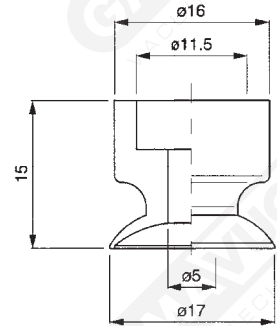

art. VSP 17/3

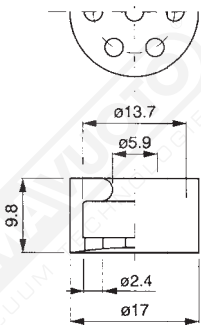

art. VSP 17/4

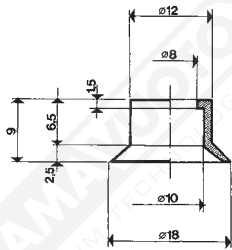

art. VSP 18

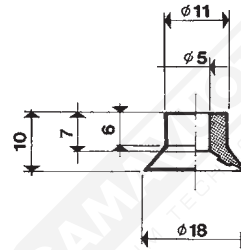

art. VSP 18/1

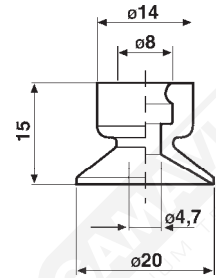

art. VSP 18/2

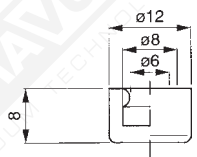

TAP 12x6x8E

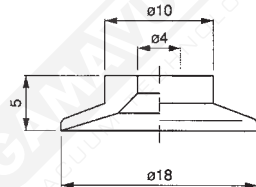

art. VSP 18/3

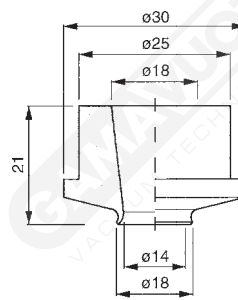

art. VSP 18/4

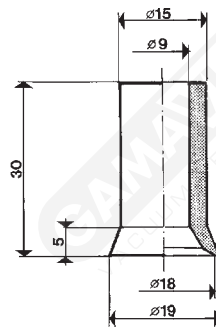

art. VSP 19

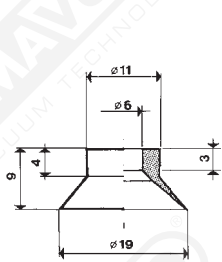

art. VSP 19/1

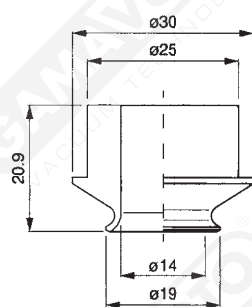

art. VSP 19/2

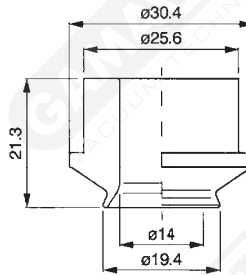

art. VSP 19/3

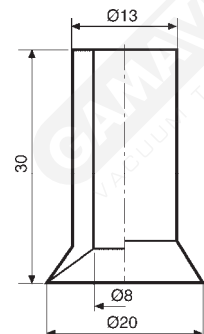

art. VSP 20

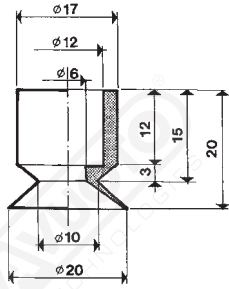

art. VSP 20/1

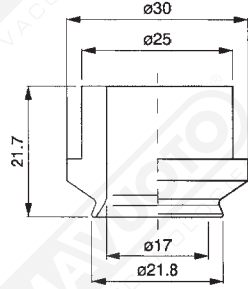

art. VSP 20/2

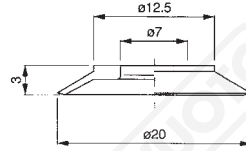

art. VSP 20/3

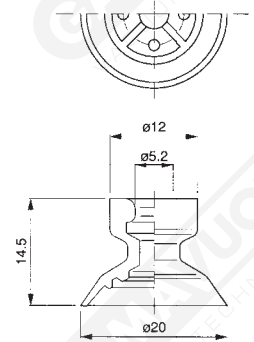

art. VSP 20/4

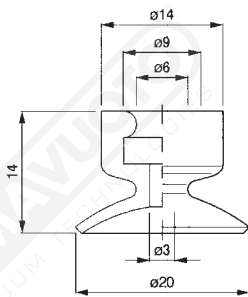

art. VSP 20/5

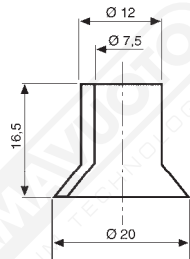

art. VSP 20/6

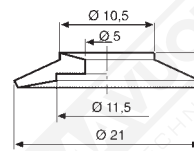

art. VSP 21

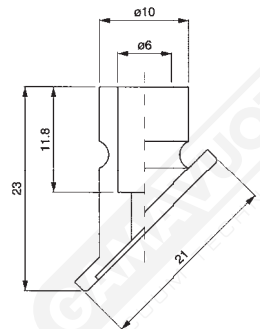

art. VSP 21/1

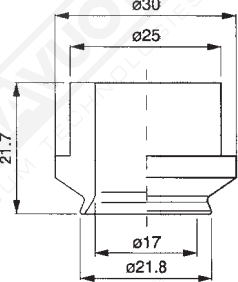

art. VSP 21/2

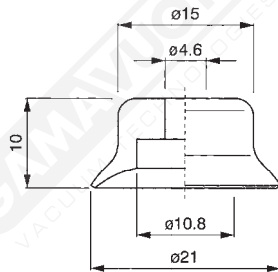

art. VSP 21/3

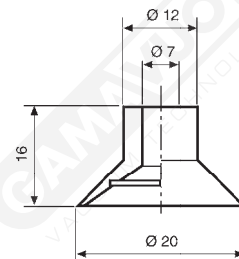

art. VSP 22

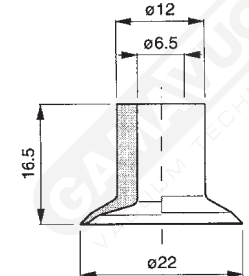

art. VSP 22/1

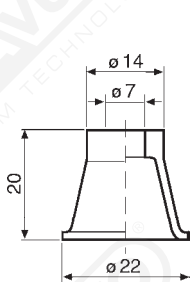

art. VSP 23

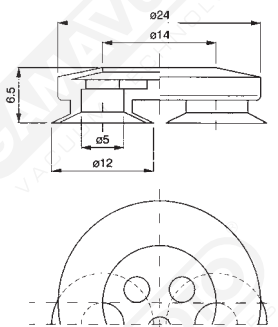

art. VSP 24/2

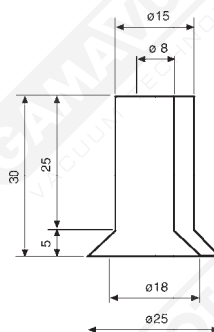

art. VSP 25

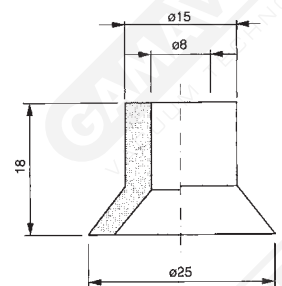

art. VSP 25/1

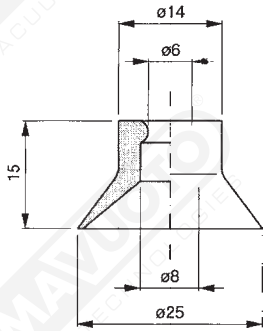

art. VSP 25/2

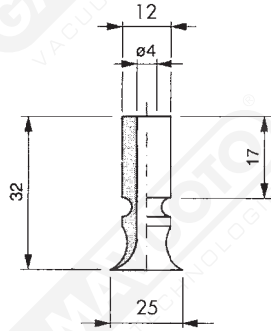

art. VSP 25/3

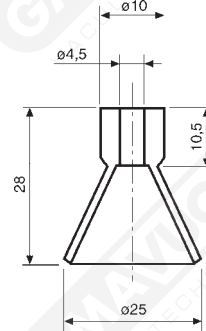

art. VSP 25/4

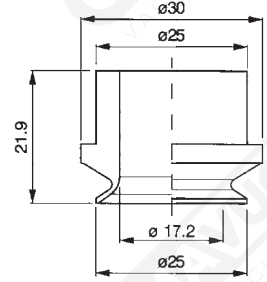

art. VSP 25/5

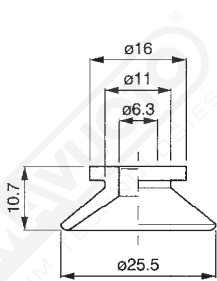

art. VSP 25/6

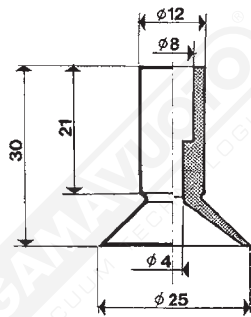

art. VSP 26

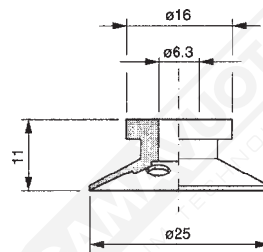

art. VSP 26/1

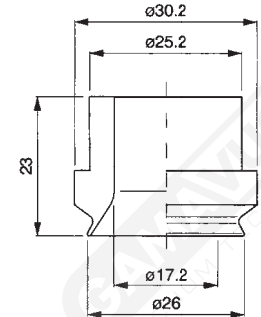

art. VSP 26/2

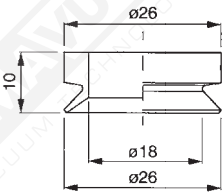

art. VSP 26/3

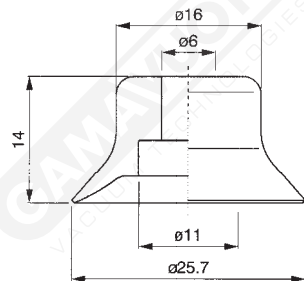

art. VSP 26/4

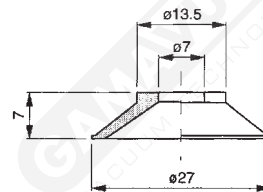

art. VSP 27

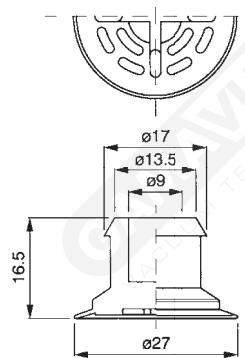

art. VSP 27/1

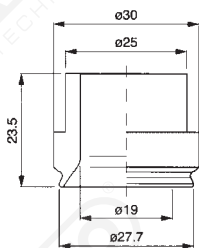

art. VSP 27/2

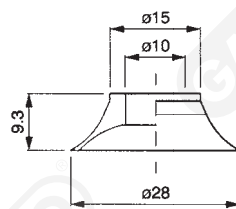

art. VSP 28/1

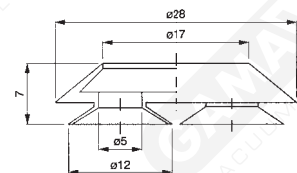

art. VSP 28/2

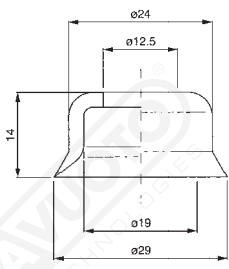

art. VSP 29

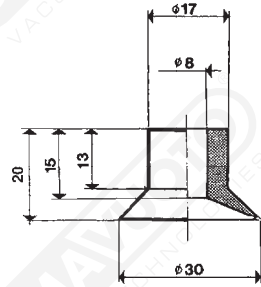

art. VSP 30

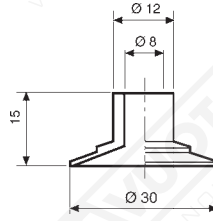

art. VSP 30/1

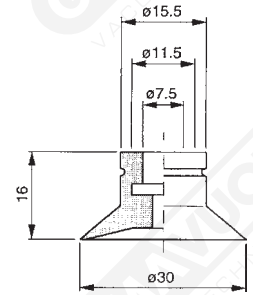

art. VSP 30/2

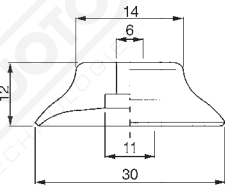

art. VSP 30/3

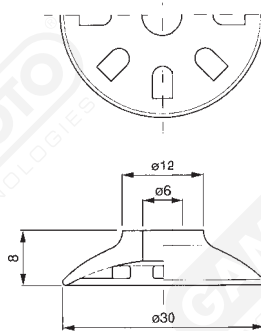

art. VSP 30/4

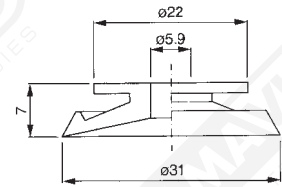

art. VSP 31/1

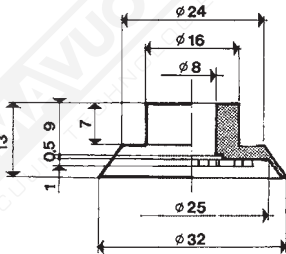

art. VSP 32

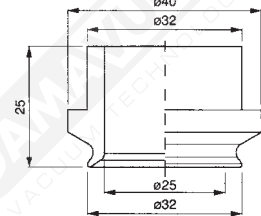

art. VSP 32/1

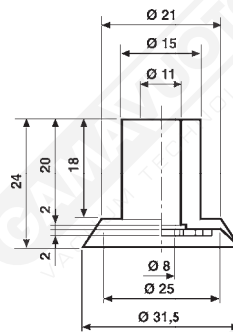

art. VSP 32/L

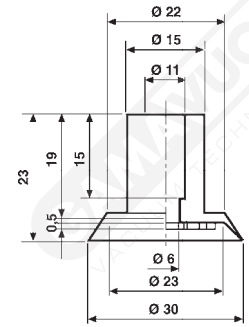

art. VSP 32/L1

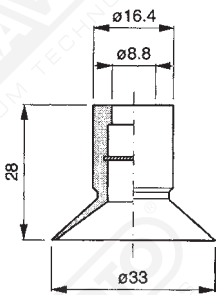

art. VSP 33

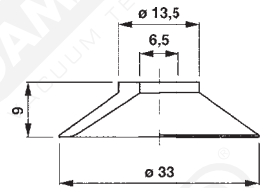

art. VSP 33/1

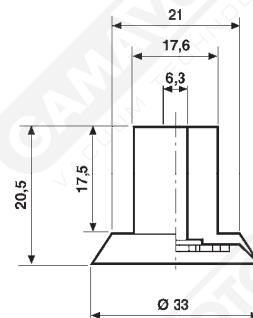

art. VSP 33/2

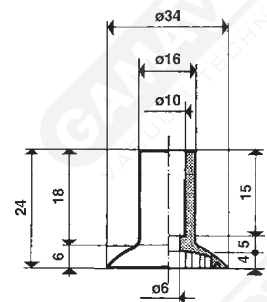

art. VSP 34

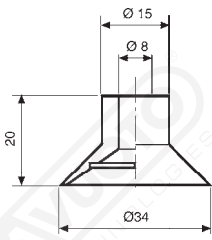

art. VSP 34/A

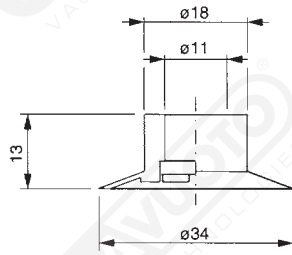

art. VSP 34/1

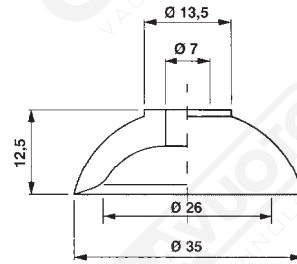

art. VSP 35

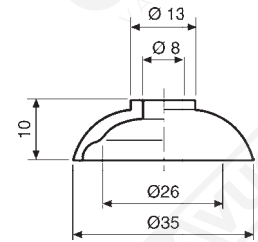

art. VSP 35/A

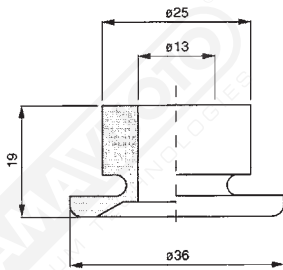

art. VSP 36/1

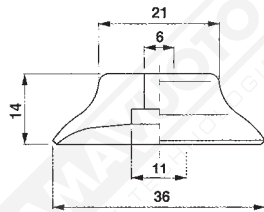

art. VSP 36/2

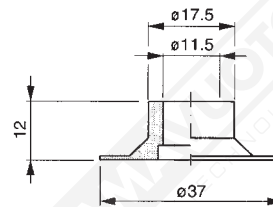

art. VSP 37

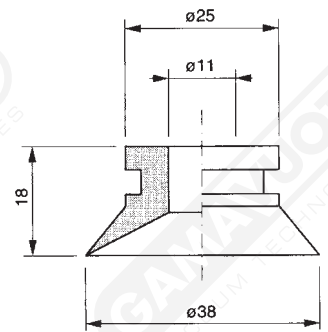

art. VSP 38

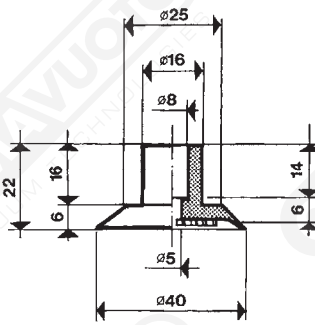

art. VSP 40

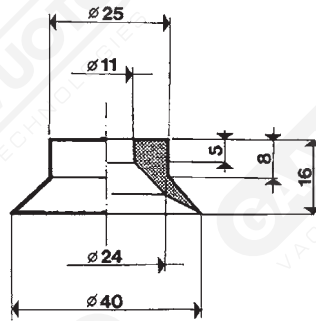

art. VSP 40/1

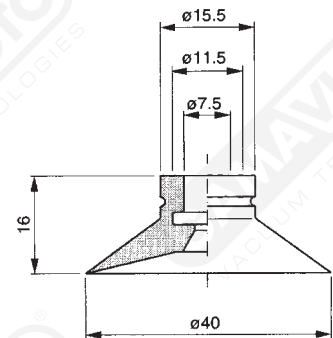

art. VSP 40/2

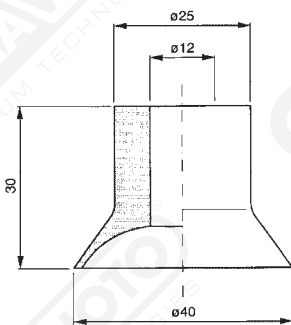

art. VSP 40/3

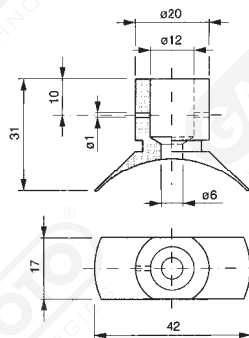

art. VSP 41

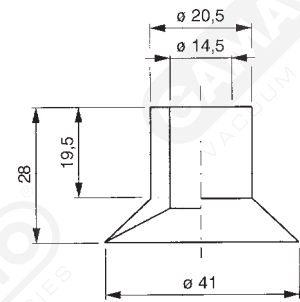

art. VSP 41/1

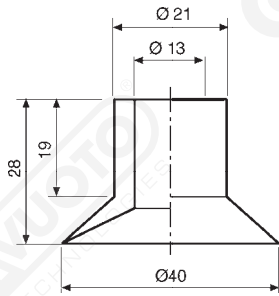

art. VSP 42

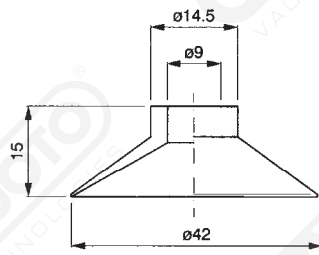

art. VSP 42/1

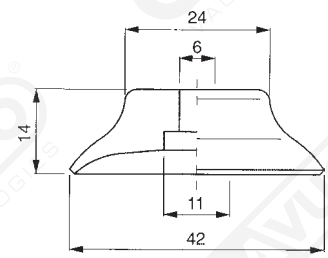

art. VSP 42/3

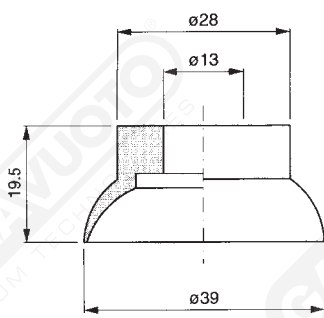

art. VSP 43

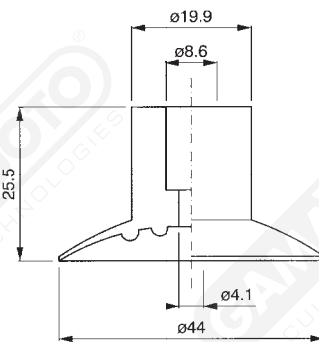

art. VSP 44

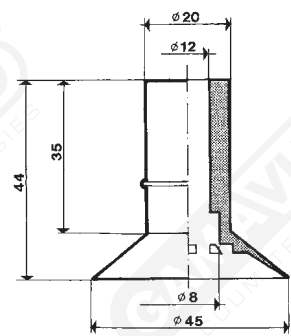

art. VSP 45

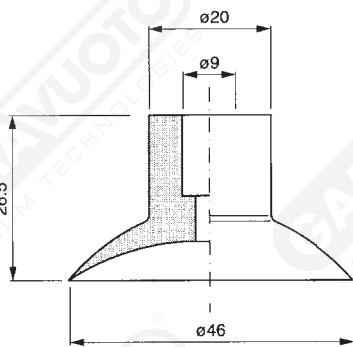

art. VSP 46

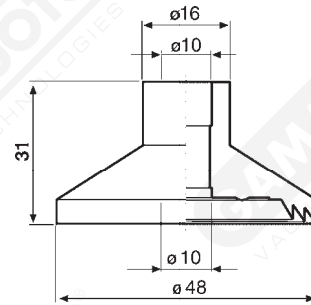

art. VSP 48

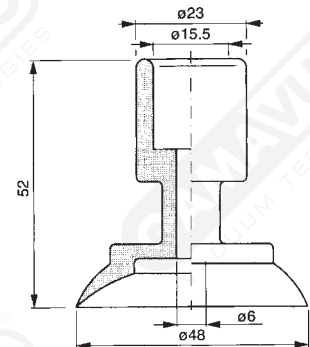

art. VSP 48/1

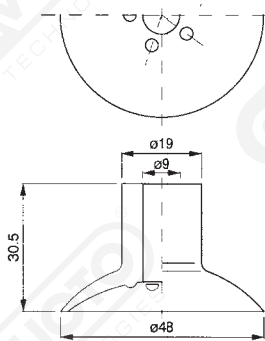

art. VSP 48/2

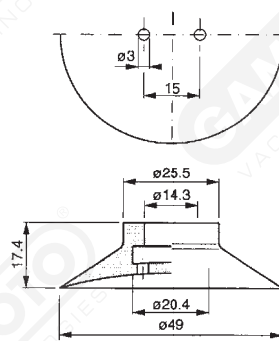

art. VSP 49

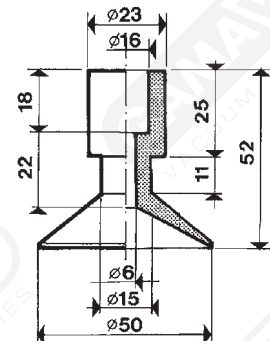

art. VSP 50

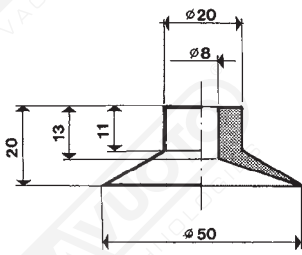

art. VSP 50/1

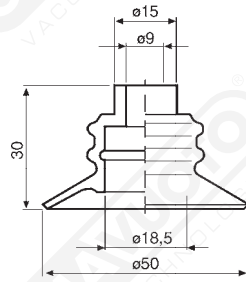

art. VSP 50/2

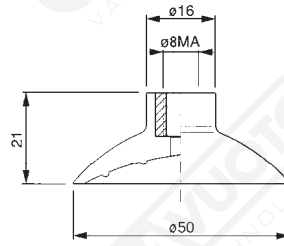

art. VSP 50/3

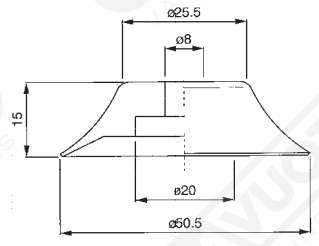

art. VSP 50/4

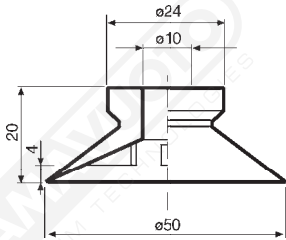

art. VSP 50/8

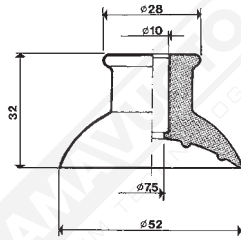

art. VSP 52

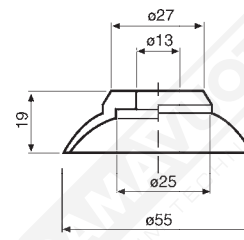

art. VSP 55

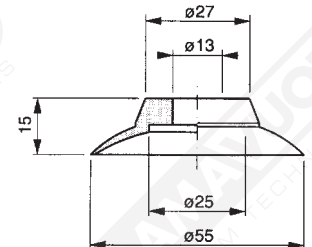

art. VSP 55/1

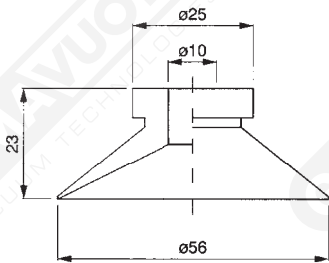

art. VSP 56

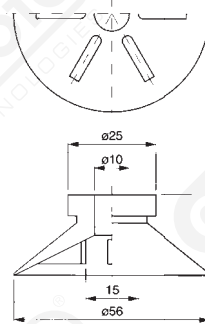

art. VSP 56/8

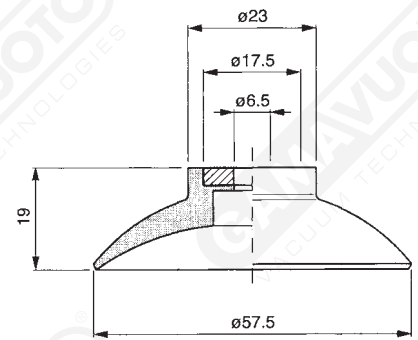

art. VSP 57

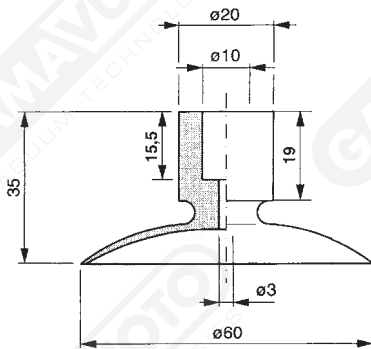

art. VSP 60

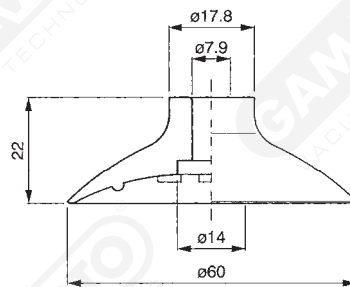

art. VSP 60/1

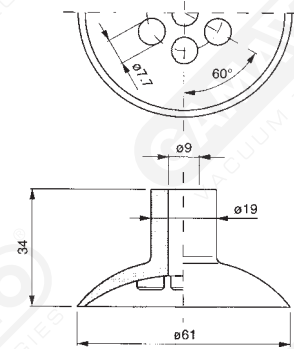

art. VSP 61

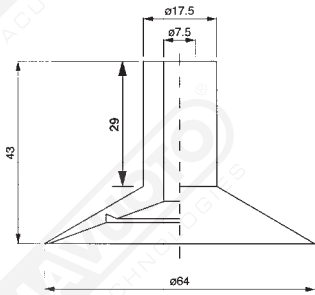

art. VSP 64

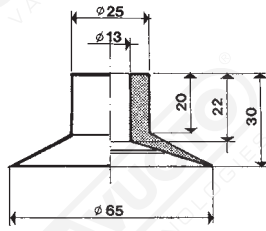

art. VSP 65/1

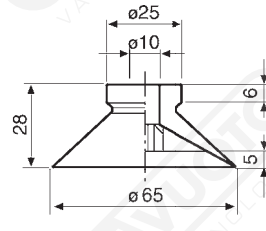

art. VSP 65/8

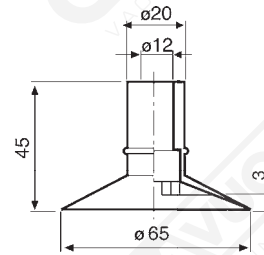

art. VSP 65/8L

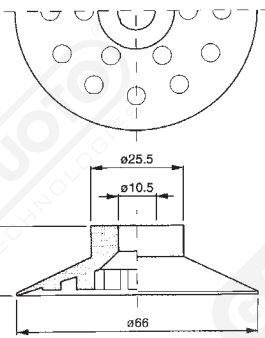

art. VSP 66

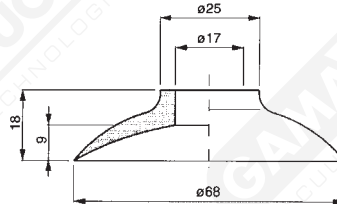

art. VSP 68

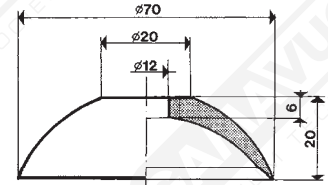

art. VSP 70

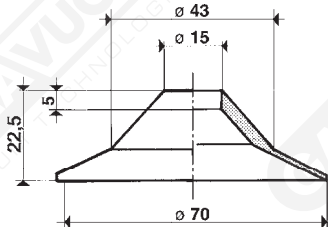

art. VSP 70/1

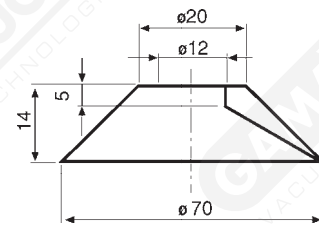

art. VSP 70/2

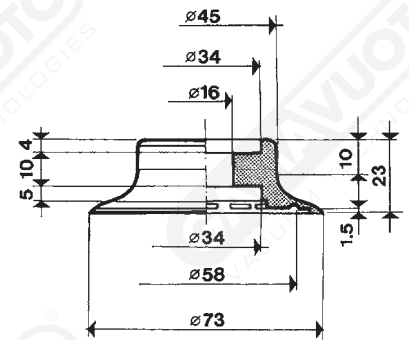

art. VSP 73

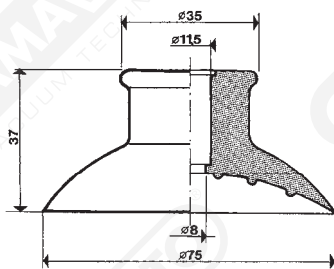

art. VSP 75

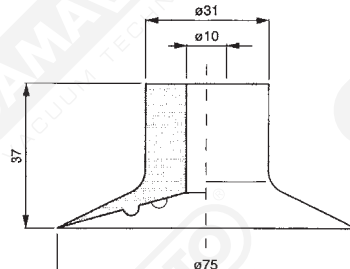

art. VSP 75/1

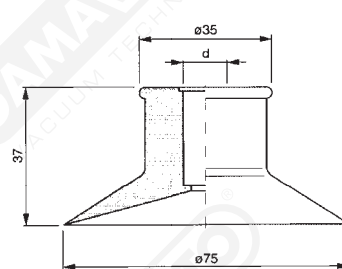

Art.	d
VSP 75/A	11,5
EM 75/A 12	12 MA
EM 75/A 14	1/4"

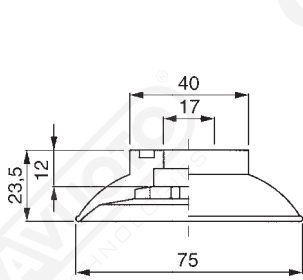

art. VSP 75/3

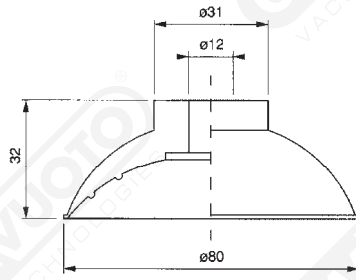

art. VSP 80

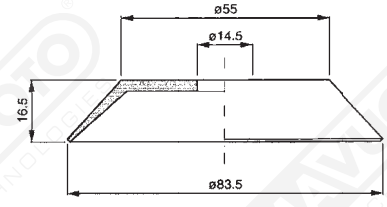

art. VSP 83

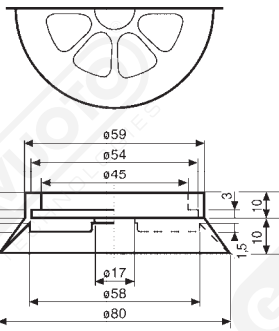

art. VSP 85

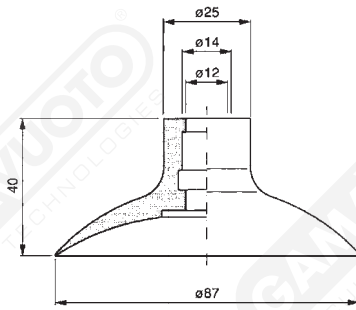

art. VSP 87

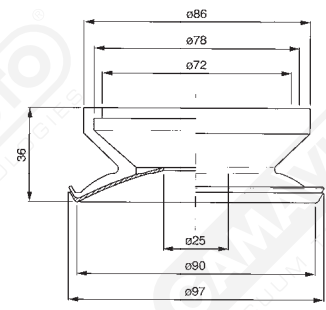

art. VSP 97

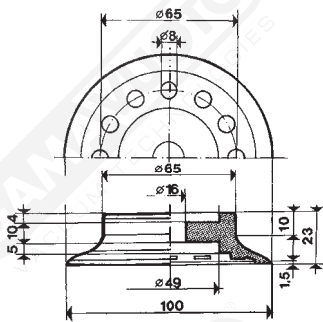

art. VSP 100

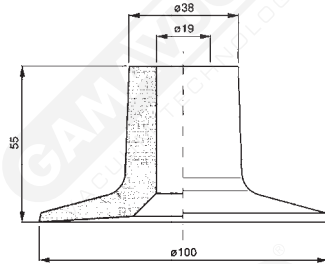

art. VSP 101

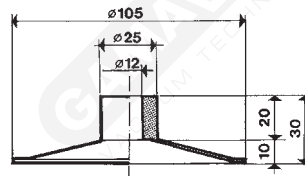

art. VSP 105

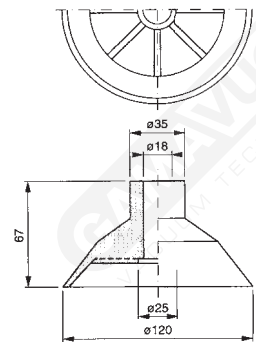

art. VSP 120

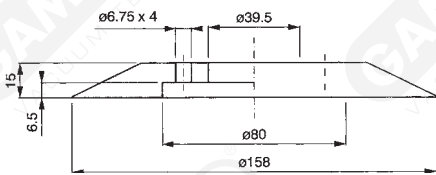

art. VSP 158

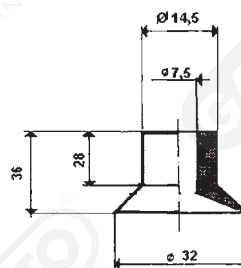

art. VSP 32/2

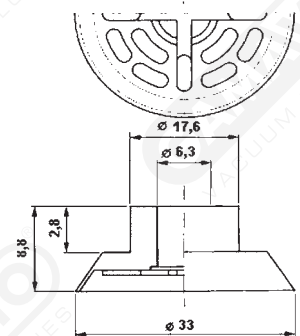

art. VSP 33/3

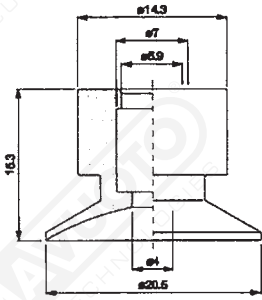

art. VSP 20/7

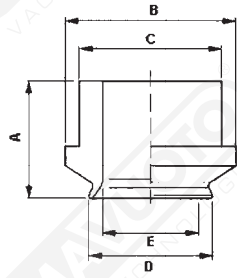

Art.	A	B	C	D	E
VSP 37/1	31	53	44,7	37	29
VSP 45/1	32	53	44,7	45	36,6

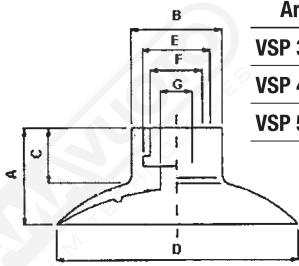

Art.	A	B	C	D	E	F	G
VSP 30/6	17	16	11	30	7	4,7	3
VSP 40/6	16	18,5	9	40	13	10	6
VSP 50/6	21	19	12	50	13	10	6

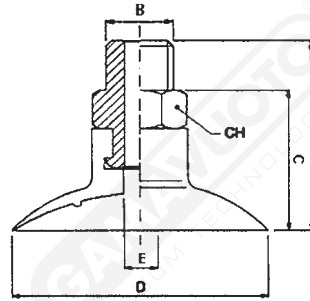

Art.	A	B	C	D	E	CH
VCM 30/6	32,5	1/8	23	30	3	14
VCM 40/6	35	1/4	25	40	6	17
VCM 50/6	39	1/4	29	50	6	17

Ventose speciali per tappi

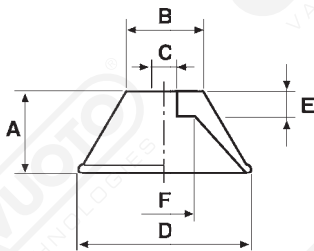

art. OM

Art.	A	B	C	D	E	F
OM 28	13	16,5	6	28	4,5	13
OM 35	16	20	6	35	5	13

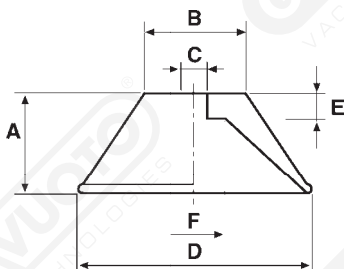

art. OM

Art.	A	B	C	D	E	F
OM 41	16	17	6,5	41	4,5	11
OM 46	15	18,5	6,5	46	5	11
OM 51	17,5	20	6,5	51	5	10