

Solar Lithium Battery Energy Storage System

User Manual Version: 1.0

Model No : HV Battery GSL- R20~60K

For On / Off Hybrid Solar Storage System



Contents

1.Safety Precautions	- 3-
1.1 Before Connecting	- 3-
1.2 During operation	- 3-
2.System Details	- 4-
2.1 Product introductionI	- 4-
2.2 Product label	- 4-
2.3 System Specifications	- 5-
2.3.1 battery module specifications	- 5-
2.3 .2 System specifications	- 6-
3. Component Description	- 7 -
3.1 high voltage control box	- 7 -
3.1.1 Interface Introduction	- 9 -
3.1.2 Indicator light introduction	- 12 -
3.2 Battery module	- 13 -
3.2.1 Bbtery module components introduction	- 14 -
4. Safe handling of lifepo4 battery guide	- 15 -
4.1 Familiar with system	- 15 -
4.2 Tools	- 15 -
4.3 Safety Gear	- 16 -
5.Installation	- 17 -
5.1 Before installation	- 17 -
5.2 Standard package list items	- 18 -
5.3 Installation Location	- 19 -
5.4 Stystem installation	- 20 -
5.5 Cale connectionI	- 23 -
5.5.1 Grounding	- 23 -
5.5.2 Cable	- 24 -
5.5.3 System turns on	- 26 -
5.5.4 System turns off	- 27 -
6.Maintenance	- 28 -
6.1 Troble shooting	- 28 -
6.1.1 Problem determination based on	- 28 -
6.1.2 Preliminary determination steps	- 28 -
6.1.3 The battery cannot be charge or discharge	- 28 -
6.2 Replacement of main component	- 29 -
6.2 .1 Replacement of battery module	- 29 -
6.3 Storage	- 30 -
6.4 Trasportation	- 30 -
6.5 Emergency situations	- 30 -

1.Safety Precautions

The HV Power Storage Battery is a high voltage DC system, operated by skilled/qualified personnel only. Read all safety instructions carefully prior to any work and observe them at all times when working on with the system. Incorrect operation or work may cause: injury or death to the operator or a third party; damage to the system hardware and other properties belonging to the operator or a third party.

- The battery needs to be recharged within 12 hours, after fully discharging.
- Do not expose cable outside.
- All battery terminals must be disconnected before maintenance.
- Do not use cleaning solvents to clean the battery.
- Do not expose the battery to flammable or harsh chemicals or vapors.
- Do not paint any part of the battery, include any internal or external components.
- Do not connect battery with PV solar wiring directly.
- Any foreign object is prohibited to be inserted into any part of the battery.
- Any foreign object is prohibited to be inserted into any part of the battery.
- Any warranty claims are excluded for direct or indirect damage due to items above.
- The HV Power Storage Battery is a high voltage DC system, operated by skilled/qualified personnel only.
- Read all safe instructions carefully prior to any work and observe them at all times when working on with the system.

1.1 Before Connecting

- After unpacking, please check the battery and packing list first, if the battery is damaged or spare parts are missing, please contact the dealer.
- Before installation, be sure to cut off the grid power and make sure the battery is in the turned-off mode;
- Wiring must be correct, do not mix-connect the positive and negative cables, and ensure no short circuit with the external device;
- It is prohibited to connect the battery with AC power directly;
- Please ensure the electrical parameters of battery system are compatible to inverter;
- Keep the battery away from fire or water.

1.2 During operation

- If the battery system needs to be moved or repaired, the power must be cut off first and the battery is completely shutdown;
- It is prohibited to connect the battery with different type of battery;
- It is prohibited to put the batteries working with faulty or incompatible inverter;
- In case of fire, only dry powder fire extinguisher can be used, liquid fire extinguishers are prohibited;
- Please do not open, repair or disassemble the battery. We do not undertake any consequences or related responsibility due to violation of safety operation or violating of design, production and equipment safety standards.

2. System Details

2.1 Production introduction

HV Power Storage Battery system is a high voltage battery storage system based on lithium iron phosphate battery, which is one of the new energy storage products developed and produced by . It can be used to support reliable power for various types of equipment and systems. HV Power Storage Battery system is especially suitable for those application scenes which required high power output, limited installation space, restricted load-bearing and long cycle life.

2.2 Product label

WARNING AVERTISSEMENT



1. Do not disassemble or alter the battery in any way.
Ne démontez ni modifiez la batterie en aucune façon.
2. Do not use the battery for purposes not described in its documentation.
N'utilisez pas la batterie à des fins non décrites dans sa documentation.
3. Do not drop, strike, puncture, or step on the battery.
Ne laissez pas tomber, ne heurtez pas, ne percez pas et ne marchez pas sur la batterie.
4. In case of electrolyte leakage, keep leaked electrolyte away from contact with eyes or skin, immediately clean with water and seek help from a doctor.
En cas de fuite d'électrolyte, évitez tout contact de l'électrolyte qui fuit avec les yeux ou la peau, nettoyez immédiatement avec de l'eau et demandez de l'aide à un médecin.
5. Do not put the battery into a fire. Do not use it or leave it in a place near fire, heaters, or high temperature sources.
Ne mettez pas la batterie au feu. Ne l'utilisez pas et ne la laissez pas à proximité de feux, de radiateurs, ou de sources de températures élevées.
6. Do not submerge the battery in water, or expose it to moisture.
Ne plongez pas la batterie dans l'eau et ne l'exposez pas à l'humidité.
7. Do not allow the terminals to contact exposed wire or metal.
Ne laissez pas les bornes entrer en contact avec du fil ou du métal exposé.
8. The battery is heavy and can cause injury if not handled safely.
La batterie est lourde et peut provoquer des blessures si elle n'est pas manipulée en toute sécurité.
9. Keep out of reach of children or animals. Tenir hors de portée des enfants ou des animaux.

2.3 System Specifications

2.3.1 Battery module specifications



Items	parameters
Battery Module Chemistry	LiFePO4
Battery module Nominal Voltage	51.2V
Battery module Rated Capacity	100Ah
Battery module Energy	5.12kWh
Dimensions (L x W x D)	482.6*132.5*500mm
Nominal working current (A)	50
Peak for 5s(A)	100
Charging temperature range of battery	0-55°C
Discharge temperature range of battery	-20- 60°C
Number of cells in battery pack	16S1P
Lithium Battery Standard	IEC62619, CE-EMC, UN38.3, MSDS
Enclosure protection rating	IP20

2.3.2 System parameters

model of battery	GSL-R20K	GSL-R25K	GSL-R30K	GSL-R35K	GSL-R40K	GSL-R45K	GSL-R50K	GSL-R55K	GSL-R60K
Rated voltage	204.8	256	307.2	358.4	409.6	460.8	512	563.2	614.4
Rated Power(kw)	20.48	25.60	30.72	35.84	40.96	46.08	51.20	56.32	61.44
Maximum Charge and discharge current	100A								
Opetating Voltage range	184-224V	230-276V	276-336V	322-392V	368-448V	414-504V	460-560V	506-616V	552-672V
Dimension (WxDxH mm)	553*503*1011	553*503*1620	553*503*1620	553*503*1620	553*503*1620	553*503*2230	553*503*2230	553*503*2230	553*503*2230
Weight (kg)	201.4	268	309.6	351.2	392.8	434.4	499	540.6	582.2
Opetating temperature	Charge: 0°C to 55°C Discharge: -20°C to 55°C								
Waterproof	IP20								
Cycle life	6500								
Peak Charge/Disc harge Current (@25°C,5S)	125A								

3.Component Description

3.1 high voltage control box

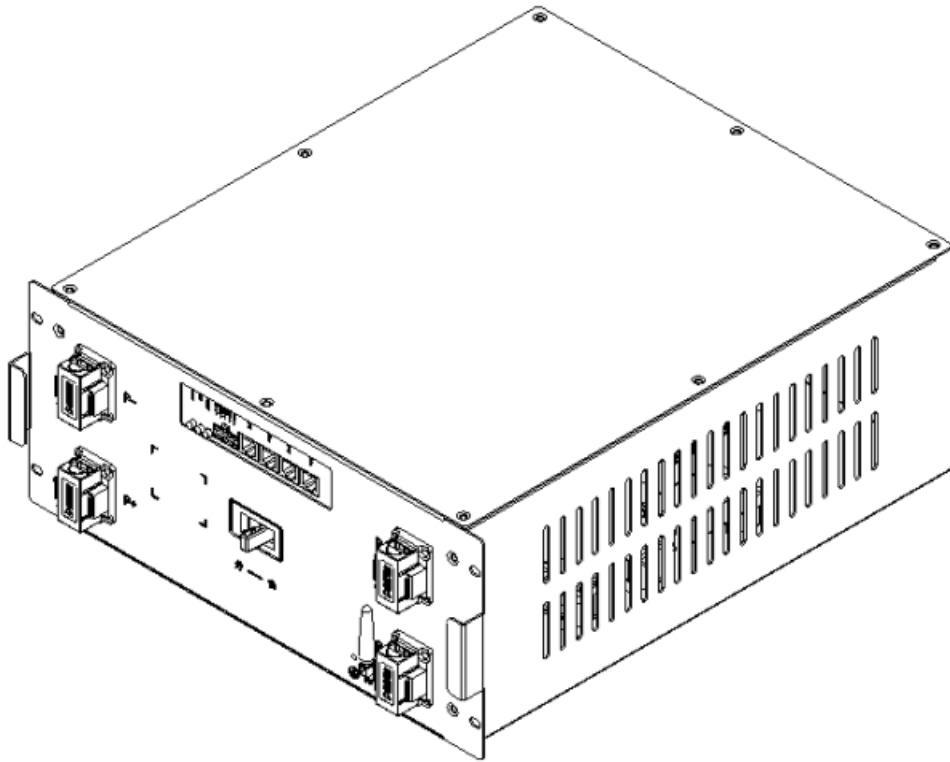

The high voltage control box, referred to as the high pressure box, is equipped with control devices, fuses and obvious power off devices, with fault alarm, fault protection, safety protection and other power and light to ensure battery electrical safety, and has the emergency stop function and the function of disconnecting the system step by step during maintenance.

Technological advantage

- Three-power supply system, 24V direct power supply, battery cluster direct power supply, board level UPS
- dual-range current sampling, sampling rate 10K, sampling accuracy <10mA
- Up to 32 packs
- IP address automatic addressing

The structure size is shown below

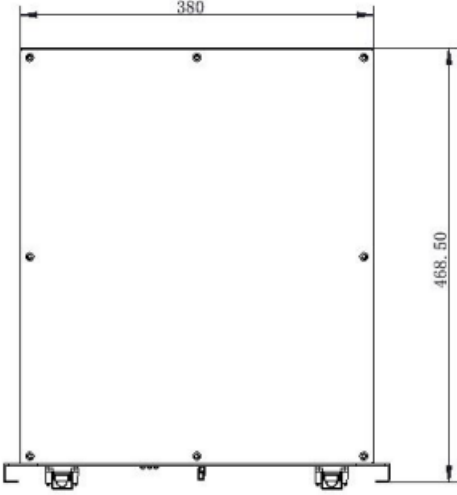
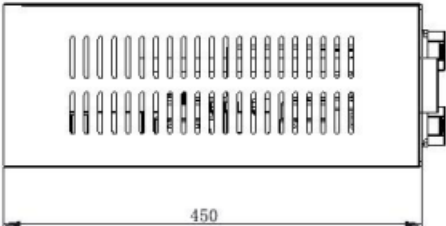
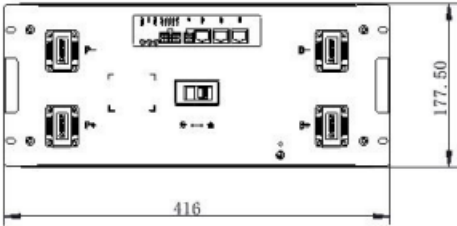

3.1.1 interface introduction

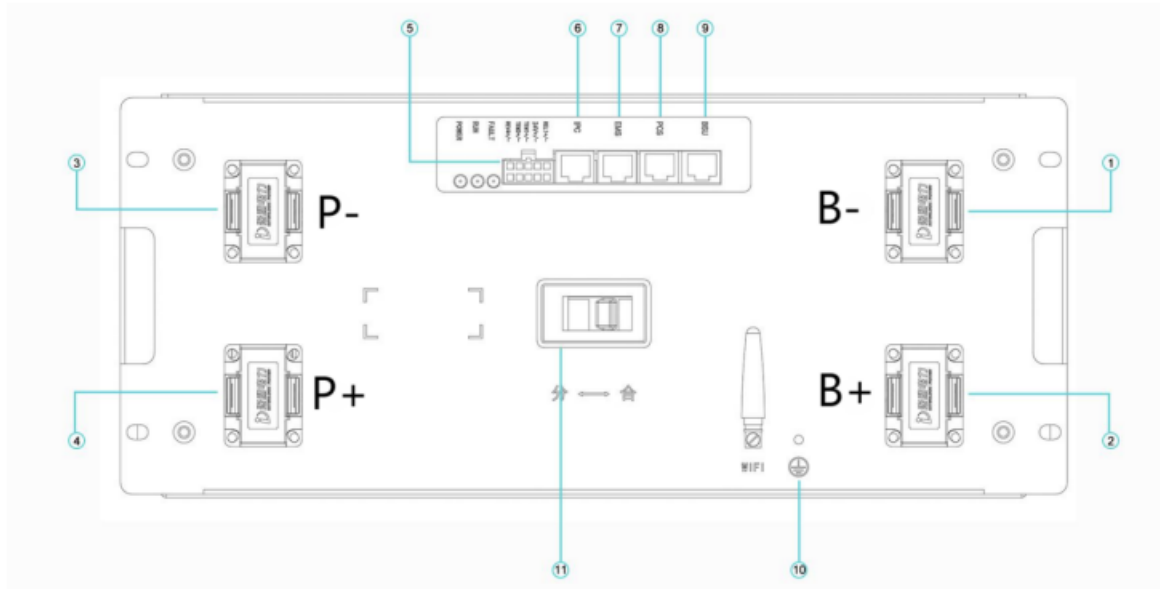

NO	Instructions	Function
1	B-	System battery total negative access point
2	B+	System battery total positive access point
3	P-	System battery negative outlet
4	P+	System battery positive outlet
5	Integrated interface	Reserve
6	IPC	Connect to industrial control equipment
7	EMS	Connect EMS
8	PCS	Connect inverter PCS
9	BSU	Connect slave control BSU
10	Ground	Ground point
11	DC breaker	Turn on/off the system

PCS pin definition (RJ45 crystal head Type B crimping method)

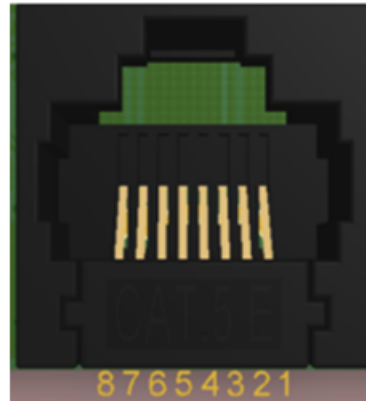
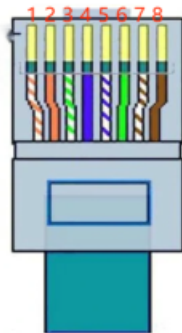

Foot Position	Color	Definition
PIN 1	White Orange	Reserved
PIN 2	Orange	Reserved
PIN 3	White Green	Reserved
PIN 4	Blue	CAN-H
PIN 5	White Blue	CAN-L
PIN 6	Green	Reserved
PIN 7	White Brown	485A
PIN 8	Brown	485B

BSU pin definition (RJ45 crystal head Type B crimping method)



Foot Position	Color	Definition
PIN 1	White Orange	VCC
PIN 2	Orange	GND1
PIN 3	White Green	ADDRESS
PIN 4	Blue	VCC
PIN 5	White Blue	GND
PIN 6	Green	CANL
PIN 7	White Brown	CANH
PIN 8	Brown	CANL

3.1.2 Indicator light introduction

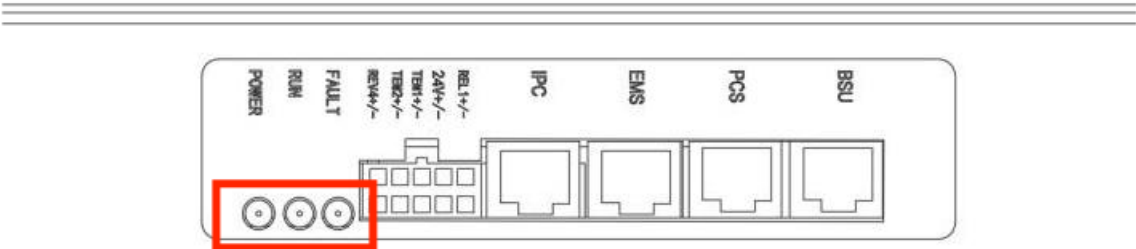

Logo	Color	Description
FAULT	red	Fault warning lamp
RUN	yellow	Normal operation
POWER	green	Power indicator light

3.2 battery module



The lithium iron phosphate battery (LiFePO₄ or LFP) is the safest of the mainstream lithium battery types. A single LFP cell has a nominal voltage of 3.2V. Nominal voltage for 51.2V of LFP battery consists of 16 cells connected in series.

LFP is the chemistry of choice for very demanding applications. Some of its features are:

- Rugged - It can operate in deficit mode during long periods of time.
- High round trip efficiency.
- High energy density - More capacity with less weight and volume.
- High charge and discharge currents - Fast charge and discharges are possible.
- Flexible charge voltages.

The lithium iron phosphate battery is therefore the chemistry of choice for a range of very demanding applications.

3.2.1 Battery module components introduction

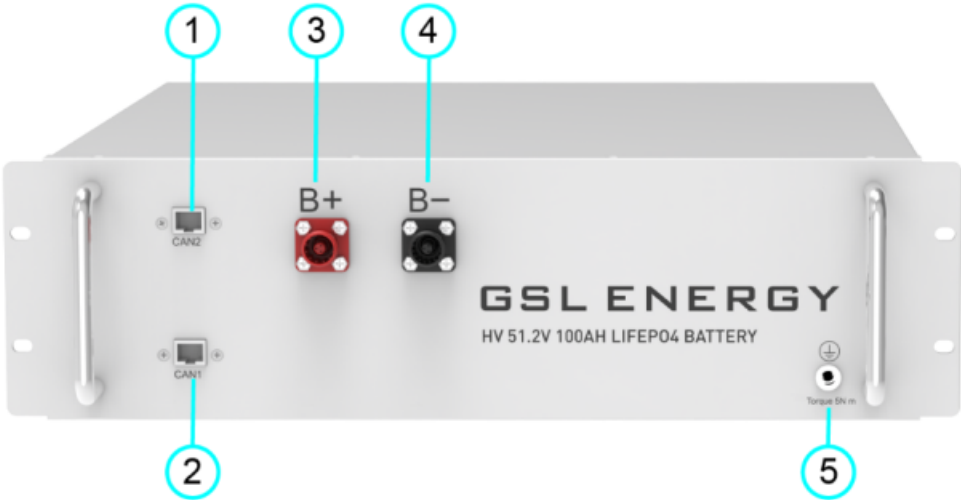

NO	Instructions
1	Battery parallel communication port
2	Battery parallel communication port
3	Power positive
4	Power negative
5	Ground terminal

4.Safe Handling of lithium Batteries Guide

4.1 Familiar with System

Be careful when unpacking the system. The whole system is heavy. Don't lift it with a pole. There are sliding wheels under the system to move. The weight of the battery can be found in the chapter "specifications".

Familiar with batteries. The battery poles are located on the right side of the battery. The battery polarity is shown on the left side of the battery. The positive pole is represented by "+" and the negative pole by "-".

Before installation, be sure to read the contents in Chapter 1 Safety Precautions, which is related to the operation Safety of installation personnel, please pay attention to.

4.2 Tools

The following tools are required to install the battery pack:



Wire cutter



Crimping Modular Plier



Screw Driver



Electronic Screw Driver



Sleeve piece



600VDC Multimeter

NOTE

- Use properly insulated tools to prevent accidental electric shock or short circuits.
- If insulated tools are not available, cover the entire exposed metal surfaces of the available tools, except their tips, with electrical tape.

4.3 Safety Gear

It is recommended to wear the following safety gear when dealing with the battery pack:



Insulated gloves



Safety goggles



Safety shoes

5. Installation

5.1 Before installation

A. Before installation and system power on, the dust and iron scurf must be removed to keep a clean environment. The system cannot be installed in desert area without an enclosure to prevent from sand.

B. HV system working temperature range: 0°C~50°C; Optimum temperature: 18°C—28°C. There is no mandatory ventilation requirements for battery module, but please avoid of installation in confined area. The aeration shall avoid of high salinity, humidity or temperature.

C. It must be equipped with fire-extinguisher system for safety purpose. The fire system needs to be regularly checked to be in normal condition. Refer to the using and maintenance requirements please follow local fire equipment guidance.

D. Before the battery installation must make sure the grounding point of the basement is stable and reliable. If the battery system is installed in an independent equipment cabin (e.g. container), must make sure the grounding of the cabin is stable and reliable. The resistance of the grounding system must $\leq 100\text{M}\Omega$

E. Minimum clearance to heat source is more than 2 meters.
Minimum clearance to battery module (rack) is more than 0.5 meters.

F. Single battery module is 89kg. If without handling tools must have more than 2 men to handling with it. The base is light, single person can handle with it.













Cation:

- **Battery module has active DC power at terminal all the time), must be careful to handle the modules.**
- GSL HV system is IP65 design. But please avoid frost or direct sunlight. Out of the working temperature range will cause the battery system over low temperature alarm or protection which further lead to the cycle life reduction. According to the environment, the cooling system or heating system should be installed if it is necessary.
- The battery pile's power terminals are high voltage DC. It must be installed in a restricted access area
- HV Power Storage Battery is a high voltage DC system, operated by qualified and authorized personnel only.

5.2 Standard package list items

Thoroughly inspect the packaging upon receipt of goods. If there is any item missing or if there is any damage to the external packaging or to the unit itself upon unpacking, please contact us immediately.

NO.	Item	Specification
1	Battery Pack 	5.12kwh
2	Control module 	.
3	Power Cable 	UL3640-4AWG,1100V, Standard+ M8 Terminal L :300mm
4		UL3640-4AWG,1100V L:800mm
5		B+, UL3640-4AWG, 1100V Standard+ M8 Terminal L:350mm
6		B-,UL3640-4AWG,1100V L:800mm
7		P+ and P-, UL3640-4AWG,1100V L:2000mm
8	Communication Cable 	Battery pcs port to Inverter Canbus port L : 2000mm

9	<p>Parallel com cable</p> 	<p>Battery com port to Battery com port L: 200mm x8 L:1000mm x2 L:</p>
10	<p>Ground cable</p> 	<p>Connect to the grounding point of the modules L:1000mm x2 L:300mm x10</p>

5.3 installation location

Make sure that the installation location meets the following conditions:

- The installation site must be suitable for the size and weight of the battery.
- Must be installed on a firm surface to sustain the weight of battery.
- The area is water proof.
- There are no flammable or explosive materials in proximity
- The ambient temperature is within the range from 0°C to 45°C.
- The temperature and humidity is maintained at a constant level.
- There is minimal dust and dirt in the area.
- Installation must be vertical or tilted backwards by maximum 15° avoid forward or side way stilt.



Caution

If the ambient temperature is outside the operating range, the battery pack stops operating to protect, itself. The optimal temperature range for the battery pack to operate is 0°C to 55°C. Frequent exposure, to harsh temperatures may deteriorate the performance and life of the battery pack.

5.4 system installation (take the R60 for example)

(1) Install each battery module in the bracket from bottom to top

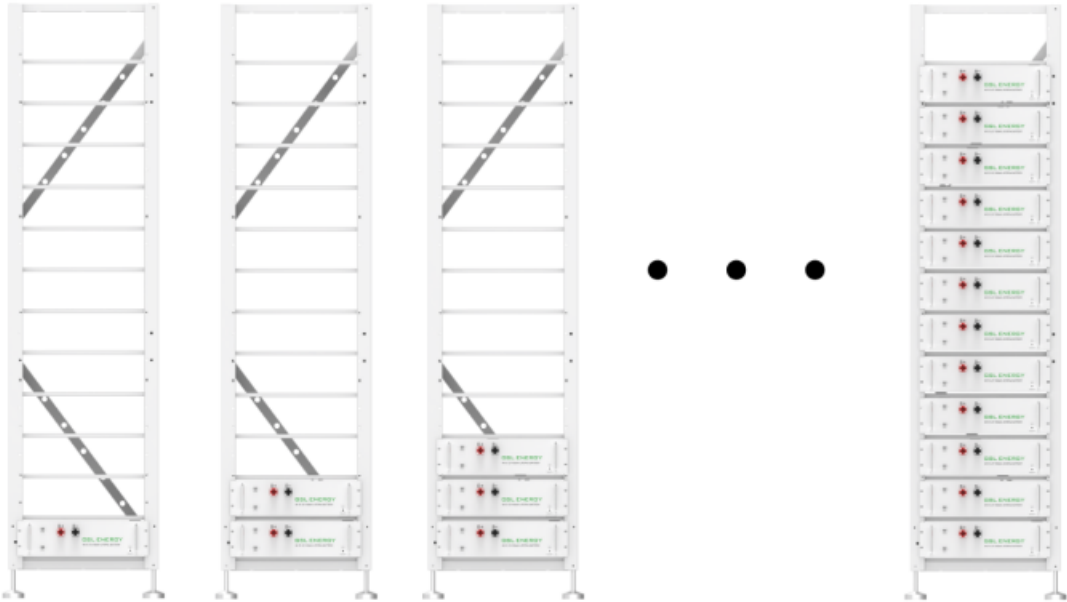

(2) Install the high voltage control box on the top of the bracket



(3) Connect the power cables between battery modules in the system as shown in the figure below , please note that the power cable should be connected from the negative electrode of the previous battery module to the positive electrode of the next battery module. The positive electrode of the top battery module and the negative electrode of the bottom battery module should be connected to the B+ and B- of the high voltage main control box



(4) Connect the communication cables between battery modules in the system as shown in the figure below. Note that the communication cable of the battery module on the top is connected to the BSU port of the high voltage main control box



(5) Connect the ground cable as shown in the figure below

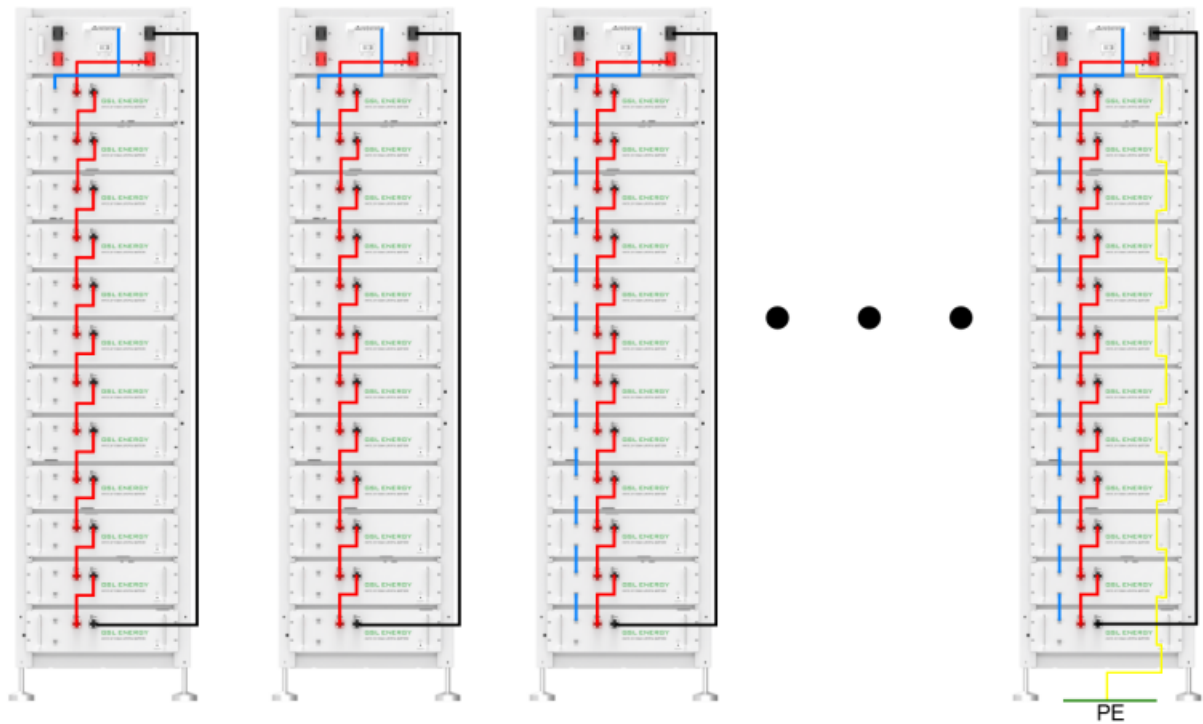

(6) Connect the battery system power positive and negative to the inverter, and the communication line to inverter's BMS port.

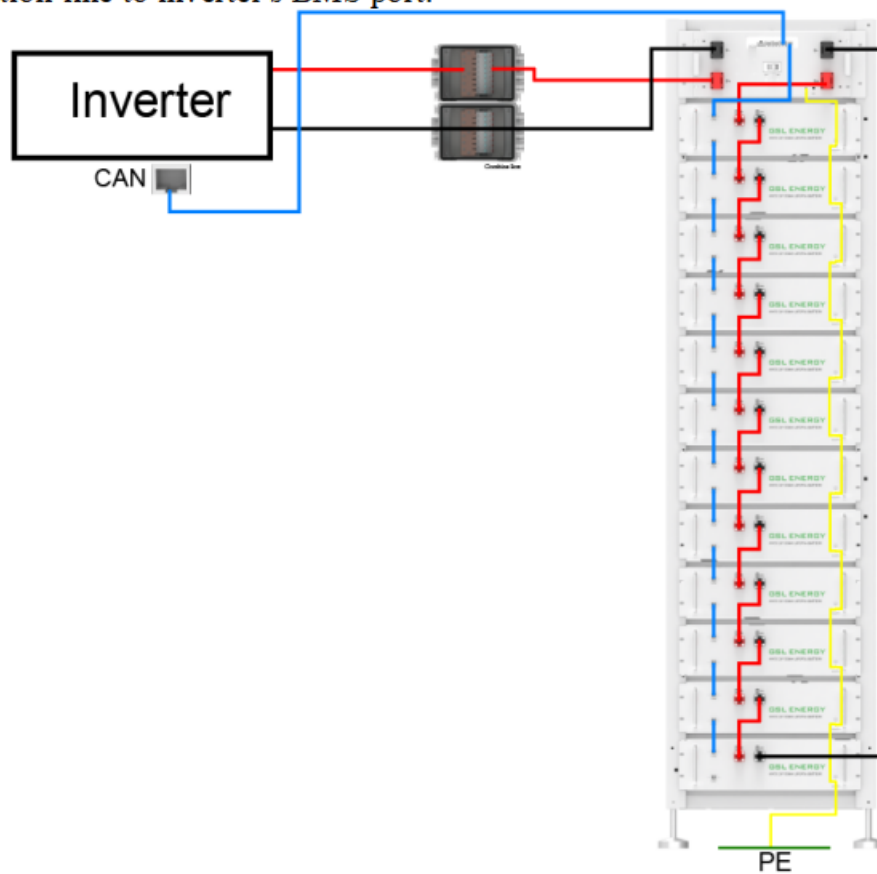

(7) Turn on the system : check that all wiring is correct, and then turn on the control switch for the entire system on the high voltage control box, then check the states of the battery system, make sure there is no abnormal.

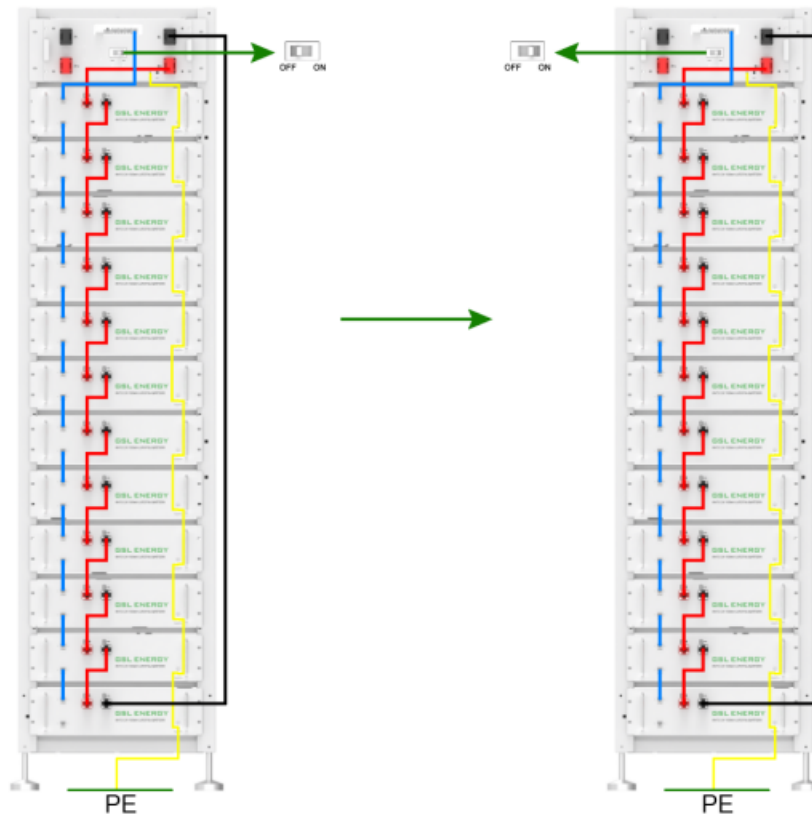

5.5 cable connection



Caution

Danger: The battery system is high voltage DC system. Must make sure the grounding is fixed and reliable

Danger: All the plugs and sockets of the power cables must be not reverse connection. Otherwise it will cause personal injury.

Danger: No short circuit or reserved connection of the battery system's positive and negative port.

Caution: Wrong communication cables connection will cause the battery system failure.

5.5.1 Grounding

The control modules grounding cable on the grounding point .

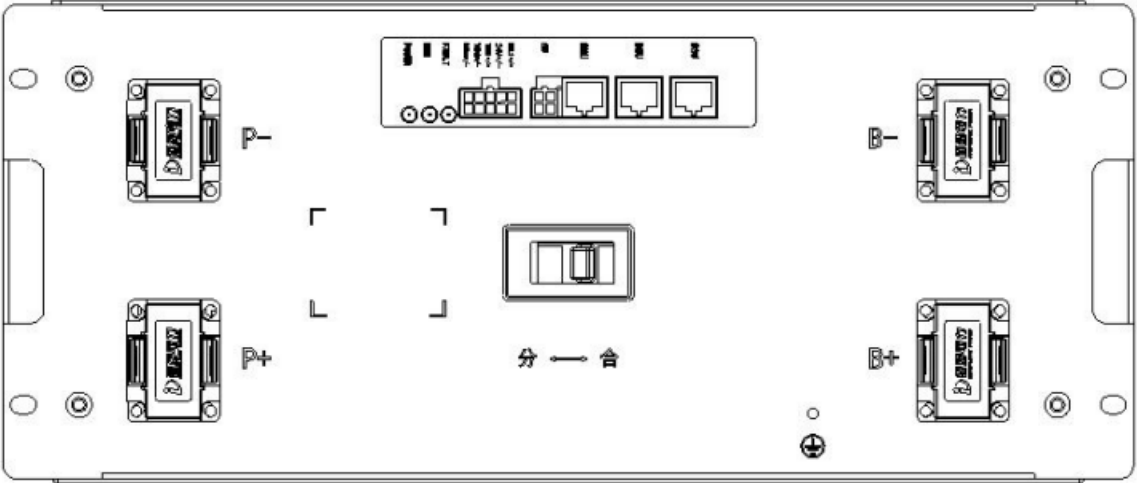

Grounding cable:

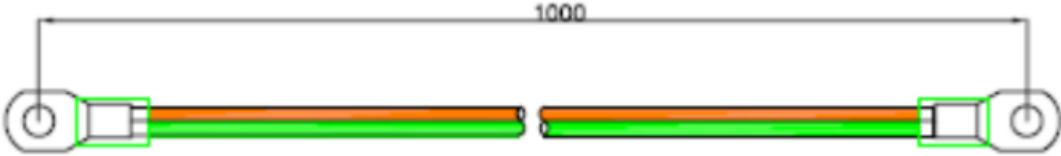

Grounding cable mustz10AWG. The cable shall be copper with yellow-green color.

5.5.2 Cable

Note: Power cable uses water-proofed connectors.Must keep pressing this Lock Button while pulling out the power plug.

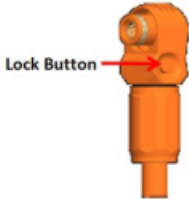

Power cables sets :

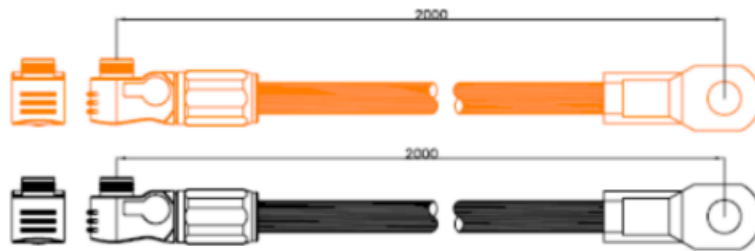

Note: Communication cable uses RJ45 connector and water-proofed cover(M19-RJ45)matched with controller connection port.



5.5.3 System turns on

Warning: Double check all the power cables and communication cables. Make sure the voltage of the inverter/PCS is same level with the battery system before connection. Check all the power switch are OFF.

System turns on step:

- 1) Check all cables are connected correctly. Check grounding is connected.
- 2) If necessary, turn on the switch at inverter's battery side or between inverter and battery. If possible, turn on AC or PV power source to wake up inverter.
- 3) Open protect cover of DC breaker. And turn on DC breaker.
- 4) Press start button, battery takes 10-30s for self checking. If inverter is turned on by AC or PV source, then most inverter can setup communication with BMS automatically, in this case, the BMS will close relay and system is ready for work.

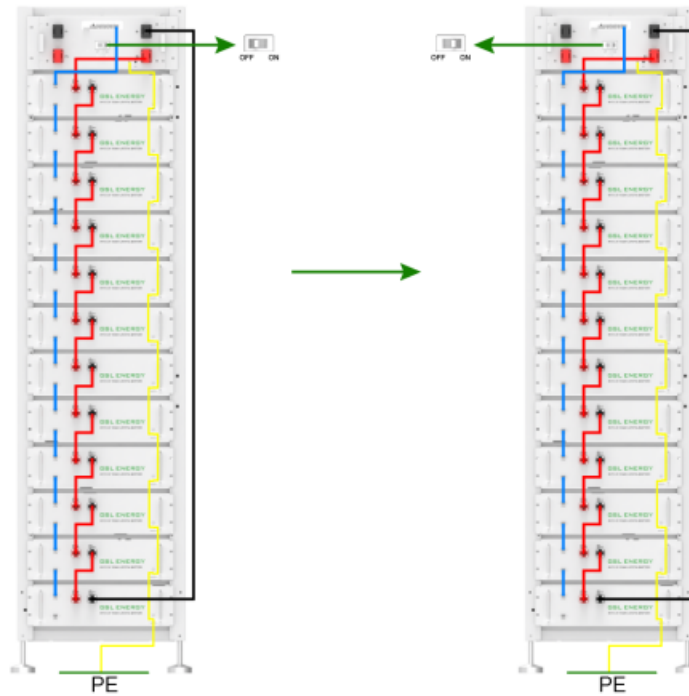

Note:

- When the breaker is tripped off because of over current or short circuit, must wait after 10min to turn on it again, otherwise may cause the breaker damage.
- During first time power on, the system will require to do fully charge progress for SOC calibration purpose.
- It is suggested to fully charge the whole Battery Energy Storage System (BESS) first after installation or after long time storage without charging. Depending on the soc level, there will be a regularly (3 month) fully charge requesting during continuous operation as well, it will be handled automatically by the communication between BESS and external device.

5.5.4 System turns off

When failure or before service, must turn the battery storage system off.

- (1) Turn off inverter or power supply on DC side.
- (2) Turn off the switch between PCS and battery system.
- (3) Turn off the "Power Switch" of the control box.

Note:

- Before replace the battery module for service, must charge/discharge the existing battery module voltage similar to the replacement. Otherwise the system need long time to do the balance for this replaced battery module.
- After the battery system installation is completed and the running is normal, you need to log in to the GSL ENERGY official website to register the product installation and use information to make the product warranty effective. Please follow the instructions on the website to register.

<http://www.gsl-energy.com> → Service → Sign UP

6.Maintenance

6.1 trouble shooting

6.1.1 Problem Determination Based On

- 1) Whether the system can be opened;
- 2) If the system is turned on, check whether the display is on;
- 3) If the display goes off, check whether the system can be charged / discharged.

6.1.2 Preliminary Determination Steps

1) The system cannot be turned on and the system display is not illuminated. If the external switch of the system is turned on and the external power supply voltage exceeds the recommended charge voltage, the system still cannot be started and operated, please contact the dealer.

2) The system can be turned on, but the display shows a fault and cannot be charged or discharged. If the red light is on, it indicates that the system is abnormal. Please check the following values:

a) Temperature: Above 55°C or under -20°C , the system could not work in

discharging. Above 55°C or under 0°C , the system could not work in charging.

b) Current: If current is greater than the maximum current, battery protection will turn on.

Solution: Check whether current is too large or not, if it is, to change the settings on the power Supply side.

c) High Voltage: If the charging voltage is above the maximum charge voltage, battery protection will turn on.

Solution: Check whether the voltage is too high or not, if it is, change the settings on the power supply side.g.

d) Low Voltage: When the battery discharges to the discharge cut off voltage or less, battery protection will turn on.

Solution: Charge the battery for some time.Excluding the four points above, if the faulty is still cannot be located, turn off the battery and repair it

Excluding the four points above, turn off battery and repair.

6.1.3 The Battery Cannot Be Charged or Discharged

1) Cannot be charged:

Disconnect the power cables, measure voltage on power side, if the voltage is between the discharge cutoff voltage and the maximum charge voltage, restart the battery,

connect the power cable.and try again, if still not work, turn off battery and contact distributor.

2) Unable to discharge:

Disconnect the power cables and measure voltage on battery side, if it is under the discharge cutoff voltage, please charge the battery, if voltage is above the normal voltage and still cannot discharge, turn off battery and contact distributor.

6.2 Replacement of main component

Note

- The HV Power Storage Battery is a high voltage DC system,operated by qualified and authorized person only.
- Before replace the main component must shut off the maintenance battery string's power. Must confirm the D+ and D- terminal are without power. The turn off progress refer to chapter 5.5.4.

6.2.1 Replacement of Battery Module

A.Charge existing module to full (SOC 100%). Make sure new battery module is 100% as well.

B.Turn off the whole battery string's power. Must confirm the D+and D-terminal are without power. The turn off progress refer to chapte5.5.4.

C. Dismantle D+ and D- Power Cable, Communication Cable and Grounding Cable.

D.Move the the battery to be replaced from the bracket.

Danger: There is a high current voltage between the red and black terminals of the battery. Cover the battery with a cover during handling to prevent personal injury



Note

- If hands under this red marked side, hands will get hurt.
- Single battery module is 35kg. If without handling tools must more than 2men to handling with it.

E. Pile up the new battery module to the bracket.

F. Install Grounding Cable, Communication Cable and the D+ and D- Power Cable

G. Turn on this battery string. Refer to chapter 5.5.3.

6.3 Storage

Recharge and maintain the battery pack regularly every three months to ensure the battery is in the best condition.

Don't store the battery at 0% SOC for over one month, this may result in permanent damage to the battery and void the warranty.

6.4 Transportation

Battery packs need to be packed before they can be shipped, during transportation, severe impact, extrusion, direct sunlight, and rain should be protected.

6.5 Emergency Situations

1). Leaking Batteries

If the battery pack leaks electrolyte, avoid contact with the leaking liquid or gas. If one is exposed to the leaked substance, immediately perform the actions described below. Inhalation: Evacuate the contaminated area and seek medical attention.

Contact with eyes: Rinse eyes with flowing water for 15 minutes and seek medical attention.

Contact with skin: Wash the affected area thoroughly with soap and water and seek medical attention.

Ingestion: Induce vomiting and seek medical attention.

2). Fire

NO WATER! Only dry powder fire extinguisher can be used; if possible, move the battery pack to a safe area before it catches fire.

3). Wet Batteries

If the battery pack is wet or submerged in water, do not allow any person access, and then contact an authorized dealer for technical support.

4). Damaged Batteries

Damaged batteries are dangerous and must be handled with extreme care. They are not suitable for use and may cause danger to persons or property. If the battery pack appears to be damaged, place it in the original container and return it to an authorized dealer.

Note

- Damaged batteries may leak electrolyte or produce flammable gas.
- In case a damaged battery needs recycling, it shall follow the local recycling regulation to process, and using the best available techniques to achieve a relevant recycling efficiency.

