



User Manual

W620W

Software Version: 2.16.24

Release Date: 2026/01/20

Directory

Directory	2
1 Picture	7
2 Table	12
3 Safety Instruction	13
3.1 Safety Instruction	13
3.2 Battery Warning	13
4 Overview	15
4.1 Overview	15
4.2 Packing Contents	15
5 Desktop Installation	16
5.1 Install the battery	16
5.2 Replacement battery	17
5.3 Connect the charging base	18
5.4 Install the belt clip	18
6 Appendix Table	19
6.1 Appendix I - Icon	19
6.2 Appendix II - Keyboard character query table	21
6.3 Appendix III - LED Definition	22
7 Introduction to the User	23
7.1 Instruction of Keypad	23
7.2 Using Handset / Hands-free Speaker / Headset	25
7.3 Power on/off operation	25
7.4 Connection Wi-Fi	26
7.5 Connect to Bluetooth	28
7.6 Sleep State	30
7.7 Standby Interface	30
7.8 Phone Status	31
7.9 Web Management	32
7.10 SIP Configurations	33
8 Basic Function	35
8.1 Making Phone Calls	35
8.2 Answering Calls	36
8.2.1 Talking	37
8.2.2 Make / Receive Second Call	37

8.3 End of the Call	38
8.4 Redial	39
8.5 Dial-up Query	39
8.6 Auto-Answering	40
8.7 Callback	41
8.8 Mute	42
8.8.1 Mute the Call	42
8.8.2 Ringing Mute	42
8.9 Call Hold/Resume	43
8.10 DND	43
8.11 Call Forward	45
8.12 Call Transfer	47
8.12.1 Blind transfer	48
8.12.2 Semi-Attended transfer	48
8.12.3 Attended transfer	48
8.13 Call Waiting	49
8.14 Conference	50
8.14.1 Local Conference	50
8.14.2 Network Conference	51
8.15 Anonymous Call	52
8.15.1 Anonymous Call	52
8.15.2 Ban Anonymous Call	53
8.16 Hotline	53
8.17 Emergency Call	54
9 Advance Function	56
9.1 Video Preview	56
9.2 Video Call	57
9.3 One-Click to Open Door	58
9.3.1 Door Opening in Standby Mode	58
9.3.2 Door Opening in Standby Mode	59
9.4 Record	60
9.4.1 Server Record	60
9.4.2 SIP INFO Record	61
9.5 Agent	61
9.6 Intercom	63
9.7 MCAST	64
9.8 Message	65
9.8.1 SMS	65

9.8.2 MWI (Message Waiting Indicator)	65
9.9 SIP Hotspot	67
10 Phone Settings	70
10.1 Basic Settings	70
10.1.1 Language	70
10.1.2 Time & Date	70
10.1.3 Screen	72
10.1.3.1 Brightness and backlight	72
10.1.3.2 Screen Saver	73
10.1.4 Ring	73
10.1.5 Voice Volume	73
10.1.6 Greeting Words	73
10.1.7 Reboot	73
10.2 Phone Book	74
10.2.1 Local Contact	74
10.2.1.1 Add / Edit / Delete Contact	74
10.2.1.2 Add / Edit / Delete Group	75
10.2.1.3 Browse and Add / Remove Contacts in Group	76
10.2.2 Blocked List	76
10.2.3 Cloud Contacts	77
10.2.3.1 Configure Cloud Contacts	77
10.2.3.2 Downloading Cloud Contacts	78
10.3 Call Log	78
10.4 Function Key	80
10.5 Wi-Fi	81
10.6 Headset	81
10.6.1 Wired Headset	81
10.6.2 Bluetooth Headset	81
10.7 Advanced	82
10.7.1 Line Configurations	82
10.7.2 Network Settings	83
10.7.2.1 Network Settings	83
10.7.2.2 VPN	85
10.7.2.3 Web Server Type	86
10.7.3 Set The Secret Key	86
10.7.4 Auto provision	88
10.7.5 Firmware Upgrade	91
10.7.6 Factory Reset	93

11 Web Configurations	94
11.1 Web Page Authentication	94
11.2 System >> Information	94
11.3 System >> Account	94
11.4 System >> Configurations	94
11.5 System >> Upgrade	95
11.6 System >> Auto Provision	95
11.7 System >> Tools	95
11.8 System >> Reboot Phone	95
12 Network >> Basic	96
12.1 Network >> Wi-Fi Settings	96
12.2 Network >> Service Port	97
12.3 Network >> VPN	97
12.4 Network >> Advanced	97
12.5 Line >> SIP	98
12.6 Line >> SIP Hotspot	103
12.7 Line >> Dial Plan	103
12.8 Line >> Action Plan	106
12.9 Line >> Basic Settings	107
12.10 Line >> RTCP-XR	107
12.11 Phone settings >> Features	108
12.12 Phone settings >> Media Settings	112
12.13 Phone settings >> MCAST	113
12.14 Phone settings >> Action	114
12.15 Phone settings >> Time/Date	114
12.16 Phone settings >> Time Plan	115
12.16.1 Repeat Period Select Daily	117
12.16.2 Repeat Period Select Weekly	118
12.16.3 Time Plan List	118
12.16.4 Delete	118
12.17 Phone settings >> Tone	119
12.18 Phone settings >> Advanced	119
12.19 Phonebook >> Contact	120
12.20 Phonebook >> cloud contacts	120
12.21 Phonebook >> Call List	121
12.22 Phonebook >> Web Dial	121
12.23 Phonebook >> Advanced	122
12.24 Call Log	122

12.25 Function Key >> Function Key	122
12.26 Function Key >> Softkey	123
12.27 Function Key >> Advanced	124
12.28 Application >> Manage Recording	125
12.29 Security >> Web Filter	125
12.30 Security >> Trust Certificates	125
12.31 Security >> Device Certificates	126
12.32 Security >> Firewall	127
12.33 Device Log >> Device Log	128
13 Trouble Shooting	129
13.1 Get Device System Information	129
13.2 Power on/off	129
13.3 Reboot Device	129
13.4 Reset Device to Factory Default	129
13.5 Screenshot	129
13.6 Network Packets Capture	130
13.7 Get Log Information	130
13.8 Get Bluetooth Data Packet	131
13.9 One-click Export Debug Info	131
13.10 Common Trouble Cases	132

1 Picture

Picture 1 - packing contents	15
Picture 2 - Install the battery	16
Picture 3 - Replacement battery	17
Picture 4 - Connect the charging base	18
Picture 5 - Install the belt clip	18
Picture 6 - W620W key layout	23
Picture 7 - W620W setup wizard	26
Picture 8 - Wi-Fi connection on the device side	26
Picture 9 - Web connection Wi-Fi	27
Picture 10 - Wi-Fi Quick Connection	27
Picture 11 - Mobile phone scanning the Wi-Fi QR code - Available Networks	28
Picture 12 - Mobile phone scanning the Wi-Fi QR code - Manually configure	28
Picture 13 - Connect to Bluetooth	29
Picture 14 - Sync mobile phone contacts	29
Picture 15 - Screen Layout / Default Main Interface	30
Picture 16 - Scroll Icon	31
Picture 17 - The Phone status	32
Picture 18 - WEB phone status	32
Picture 19 - Landing page	33
Picture 20 - Phone line SIP address and account information	33
Picture 21 - Web SIP registration	34
Picture 22 - Default line	35
Picture 23 - Enable voice channel dialing	35
Picture 24 - Open the voice channel and dial the number	36
Picture 25 - Call number	36
Picture 26 - Answering calls	36
Picture 27 - Talking interface	37
Picture 28 - The second call interface	38
Picture 29 - Two way calling	38
Picture 30 - Set redial DSS key	39
Picture 31 - Redial set	39
Picture 32 - Line 1 enables auto-answering	40
Picture 33 - The line has enabled auto-answering	40
Picture 34 - Web page to start auto-answering	41
Picture 35 - Set the callback key on the phone	41
Picture 36 - Set the callback key on the web page	41

Picture 37	- Mute the call	42
Picture 38	- Ringing mute	43
Picture 39	- Call hold interface	43
Picture 40	- Enable DND	44
Picture 41	- DND setting interface	44
Picture 42	- DND timer	44
Picture 43	- DND Settings	45
Picture 44	- Line DND	45
Picture 45	- Select the line to set up call forwarding	46
Picture 46	- Select call forward type	46
Picture 47	- Enable call forwarding and configure the call forwarding number	47
Picture 48	- Set call forward	47
Picture 49	- Transfer interface	48
Picture 50	- Semi-Attended transfer	48
Picture 51	- Attended transfer	49
Picture 52	- Call waiting setting	49
Picture 53	- Web call waiting setting	49
Picture 54	- Web call waiting tone setting	50
Picture 55	- Local conference setting	50
Picture 56	- Local conference (1)	50
Picture 57	- Local conference (2)	51
Picture 58	- Network conference	51
Picture 59	- Enable anonymous call	52
Picture 60	- Enable Anonymous web page call	52
Picture 61	- Anonymous call log	53
Picture 62	- Anonymous calls are not allowed on the phone	53
Picture 63	- Page Settings blocking anonymous call	53
Picture 64	- Phone hotline setting interface	54
Picture 65	- Hotline set up on web page	54
Picture 66	- Set up an emergency call number	55
Picture 67	- Dial the emergency number	55
Picture 68	- Web interface settings for SIP line video preview	56
Picture 69	- Video preview settings for IP calls on the web interface	56
Picture 70	- Web interface settings for default ans/dial mode	57
Picture 71	- Web interface settings for video display mode	58
Picture 72	- Web interface settings for URL door opening	59
Picture 73	- Door opening in standby mode	59
Picture 74	- Web interface settings for door-opening softkey	60

Picture 75	- Door opening via softkey on the handset	60
Picture 76	- Web server recording	61
Picture 77	- Web SIP info recording	61
Picture 78	- Configure the agent account in normal mode	62
Picture 79	- Configure the proxy account-hotel Guest mode	62
Picture 80	- Agent logon page	63
Picture 81	- Web Intercom configure	63
Picture 82	- Multicast Settings Page	64
Picture 83	- SMS icon	65
Picture 84	- New Voice Message Notification	66
Picture 85	- Voice message interface	66
Picture 86	- Configure voicemail number	67
Picture 87	- Register SIP account	67
Picture 88	- SIP Hotspot server configuration	68
Picture 89	- SIP Hotspot client configuration	68
Picture 90	- Phone language setting	70
Picture 91	- Language setting on Web page	70
Picture 92	- Set time & date on phone	71
Picture 93	- Set time & date on web page	71
Picture 94	- Set screen parameters on phone	72
Picture 95	- Page screen Settings	72
Picture 96	- Phone screen saver	73
Picture 97	- Phone book screen	74
Picture 98	- Local Phone book	74
Picture 99	- Add New Contact	75
Picture 100	- Group List	75
Picture 101	- Browsing Contacts in a Group	76
Picture 102	- Add Contacts in a Group	76
Picture 103	- Add Blocked List	77
Picture 104	- Web Blocked List	77
Picture 105	- Cloud phone book list	78
Picture 106	- Downloading Cloud Phone book	78
Picture 107	- Browse contacts in cloud phone book	78
Picture 108	- Call Log	79
Picture 109	- Filter call record types	79
Picture 110	- DSS LCD key Page Configuration Screen	80
Picture 111	- DSS settings	80
Picture 112	- Headset function settings	81

Picture 113	- Bluetooth Settings Screen	82
Picture 114	- SIP address and account information	82
Picture 115	- Configure Advanced Line Options	83
Picture 116	- Network mode Settings	83
Picture 117	- DHCP network mode	83
Picture 118	- PPPoE network mode	84
Picture 119	- Static IP network mode	84
Picture 120	- IPv6 Static IP network mode	85
Picture 121	- The phone configures the web server type	86
Picture 122	- Menu password	86
Picture 123	- Set menu password	87
Picture 124	- Keyboard lock password	87
Picture 125	- Set keyboard lock password	87
Picture 126	- Phone keypad lock password input interface	88
Picture 127	- Web keyboard lock password settings	88
Picture 128	- Page auto provision Settings	88
Picture 129	- Phone auto provision settings	89
Picture 130	- Web page firmware upgrade	91
Picture 131	- Firmware upgrade information display	91
Picture 132	- HTTP server download directory	92
Picture 133	- Network Priority	96
Picture 134	- Wi-Fi Settings	96
Picture 135	- Service Port Settings	97
Picture 136	- Dial plan settings	103
Picture 137	- Custom setting of dial - up rules	104
Picture 138	- Dial rules table (1)	105
Picture 139	- Dial rules table (2)	105
Picture 140	- Action Plan	106
Picture 141	- Time Plan (1)	116
Picture 142	- Time Plan (2)	117
Picture 143	- Time Plan (3)	118
Picture 144	- Time Plan (4)	118
Picture 145	- Time Plan (5)	118
Picture 146	- Time Plan (6)	119
Picture 147	- Tone settings on the web	119
Picture 148	- Web cloud phone book Settings	121
Picture 149	- Global Key Settings	124
Picture 150	- Web Filter settings	125

Picture 151 - Web Filter Table	125
Picture 152 - Certificate of settings	126
Picture 153 - Device certificate setting	126
Picture 154 - Network firewall Settings	127
Picture 155 - Firewall Input rule table	128
Picture 156 - Delete firewall rules	128
Picture 157 - Screenshot	130
Picture 158 - Web capture	130
Picture 159 - Get WLAN Log	131
Picture 160 - Get Bluetooth data packet	131
Picture 161 - One-click export debug info	131

2 Table

Table 1	- Keypad Icons	19
Table 2	- Status Prompt and Notification Icons	19
Table 3	- Look-up Table of Characters	21
Table 4	- Status Indicator LED State	22
Table 5	- Instruction of Keypad of W620W	23
Table 6	- Talking mode	37
Table 7	- Agency mode	62
Table 8	- Intercom configure	63
Table 9	- MCAST Parameters on Web	64
Table 10	- SIP Hotspot Parameters	67
Table 11	- Time Settings Parameters	71
Table 12	- Auto Provision	89
Table 13	- Firmware upgrade	91
Table 14	- Service port	97
Table 15	- Line configuration on the web page	98
Table 16	- Phone 5 dialing methods	104
Table 17	- Dial - up rule configuration table	104
Table 18	- Action Plan	106
Table 19	- Set the line global configuration on the web page	107
Table 20	- VQ RTCP-XR Settings	107
Table 21	- General function Settings	108
Table 22	- Voice settings	112
Table 23	- Multicast parameters	113
Table 24	- Time&Date settings	114
Table 25	- Time Plan	116
Table 26	- Function Key configuration	122
Table 27	- Softkey configuration	123
Table 28	- Network Firewall	127
Table 29	- Trouble Cases	132

3 Safety Instruction

3.1 Safety Instruction

Please read the following safety notices before installing or using this unit. They are crucial for the safe and reliable operation of the device.

- Please use the power adapter specified for the product. In case of special circumstances requiring the use of an adapter from another manufacturer, ensure the voltage and current of the provided adapter comply with the product's specifications. Additionally, it is recommended to use products that have passed safety certifications; otherwise, it may cause fire or electric shock hazards.
- When using this product, do not damage the power cord. Do not forcibly twist, stretch, pull, or tie the power cord; nor should you place heavy objects on it or pinch it between items. Otherwise, the power cord may be damaged, which could lead to fire or electric shock accidents.
- Before using the product, please confirm that the temperature and humidity of its environment meet the product's operating requirements. (When the product is moved from an air-conditioned room to an environment at natural temperature, condensation may form on the product's surface or internal components. Wait for the product to dry naturally before turning on the power.)
- Non-technical service personnel must not disassemble or repair the product by themselves. Improper repair may cause accidents such as electric shock or fire, and the warranty service of your product will also become invalid.
- Do not insert metal foreign objects such as pins or iron wires into the vents or gaps of the product. Otherwise, it may cause injury accidents like electric shock due to electric current passing through the metal foreign objects. If any foreign objects or similar metal items fall into the product, stop using it immediately.
- Do not discard or store the plastic bags used for packaging in places accessible to young children. This is to prevent young children from putting the plastic bags over their heads, which may block their noses and mouths and cause suffocation.
- Please use this product correctly in accordance with the instructions provided in the product manual. Prolonged improper operation may cause damage to the product and pose potential safety hazards.

3.2 Battery Warning

To prevent the battery pack from leaking, overheating and catching fire. Please observe the following precautions:

- Soft aluminum packaging foil is easily damaged by sharp edged parts such as nickel sheets, pins and needles.
- Do not hit the battery pack with any sharp parts.
- Do not immerse the battery pack in water or seawater.
- Do not use and place the battery pack near heat sources such as fire or heaters.

- Do not reverse the positive and negative poles.
- Do not connect the battery pack to the power outlet.
- Do not throw the battery pack into fire or heat.
- Do not connect the positive and negative poles directly to metal objects such as wires, which may cause a short circuit of the battery pack.
- Do not transport and store batteries together with metal items such as necklaces and hairpins.
- Do not knock or throw the battery pack.
- Do not directly solder the battery pack or battery, and do not pierce the battery with nails or other sharp objects.
- Please use the charger configured at the time of purchase when charging. [Product Overview](#).

4 Overview

4.1 Overview

W620W is a portable enterprise-grade Wi-Fi IP phone, specifically designed to meet the needs of modern mobile office environments. Equipped with Bluetooth 5.0 and dual-band 2.4G/5G Wi-Fi 6 modules, combined with advanced seamless roaming technology, it delivers stable and efficient communication performance even in dynamic wireless network environments. W620W supports 6-way voice conferences and features a 1.8-meter drop-resistant design. It is also equipped with a high-definition speaker and highly sensitive dual microphones; thanks to the dual-mic noise reduction algorithm, clear call quality is ensured even in noisy surroundings. In addition, the device has a built-in 3000mAh high-capacity battery, which can support up to 13 hours of talk time and 240 hours of standby time, significantly enhancing work continuity and flexibility. W620W is widely applicable to various mobile office scenarios such as office buildings, hotels, shopping malls, and security patrols, making it an ideal choice for enterprises looking to improve mobile communication efficiency.

To help interested users gain a better understanding of the product details, this user manual can serve as a reference guide for device usage. This document may not apply to the latest software version. If you have any questions, you can use the help prompt interface built into the device phone, or download and update your user manual from <https://fanvil.com/>.

4.2 Packing Contents

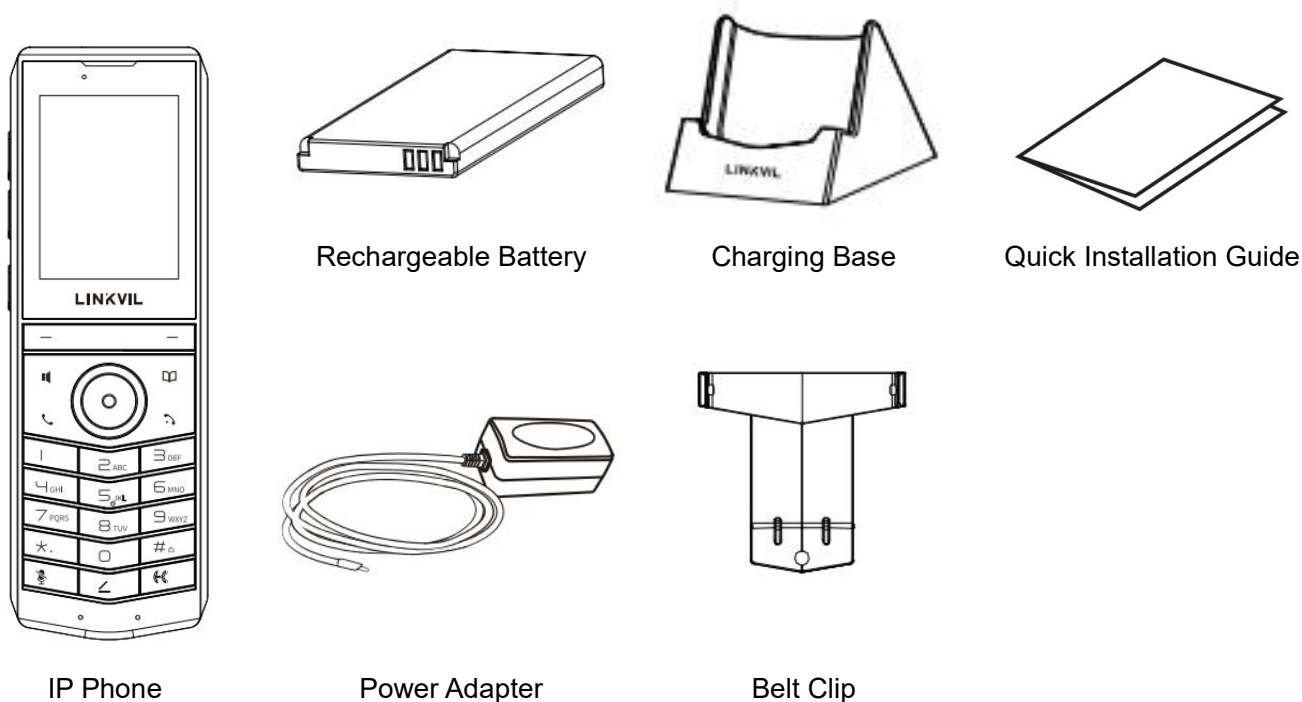

Picture 1 - packing contents

5 Desktop Installation

5.1 Install the battery

1. Removing the rear case: Remove the rear case of the whole machine with a little force from the handle position A of the rear case of the main unit.

2. Install the battery: Take out the battery from the packaging box, with the battery with the notch facing up, put the battery B at the battery compartment B.

3. Install the back cover: Align the back cover with the buckle on the back of the main unit, press your hands along the edge of the main unit from top to bottom (there will be a "click" sound during the process), and ensure that there is no gap, it means that the back cover is fastened.

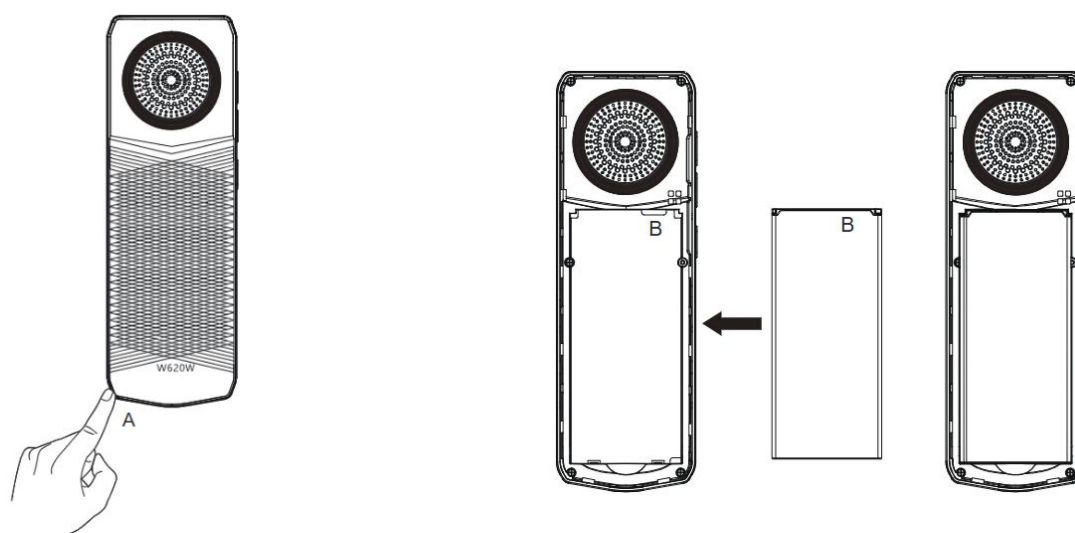

Remove the rear case

Install the battery

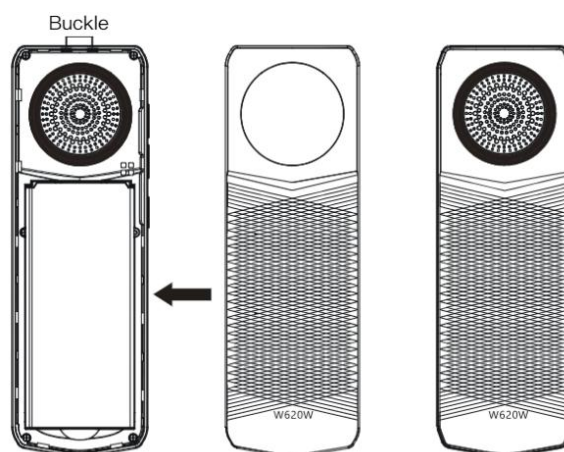

Install the back cover

Picture 2 - Install the battery

5.2 Replacement battery

1. Remove the rear case: Remove the rear case of the whole machine with a little force from the handle position A of the rear case of the main unit.
2. Remove the old battery: Push up at B to remove the old battery.
3. Install the new battery: Take out the battery from the packaging box, with the battery with the notch facing up, put the battery C at the battery compartment C.
4. Install the back cover: Align the back cover with the buckle on the back of the main unit, press your hands along the edge of the main unit from top to bottom (there will be a "click" sound during the process), and ensure that there is no gap, it means that the back cover is fastened.

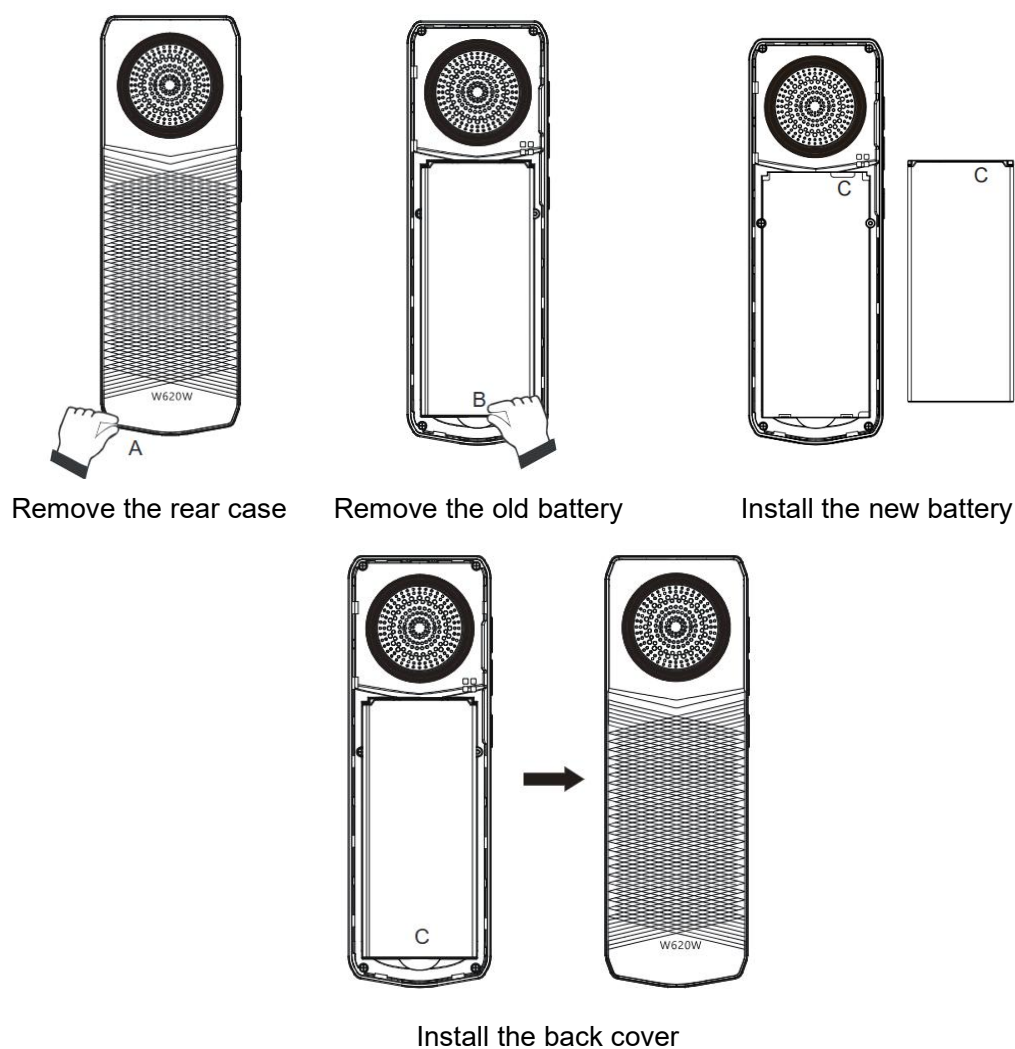

Picture 3 - Replacement battery

5.3 Connect the charging base

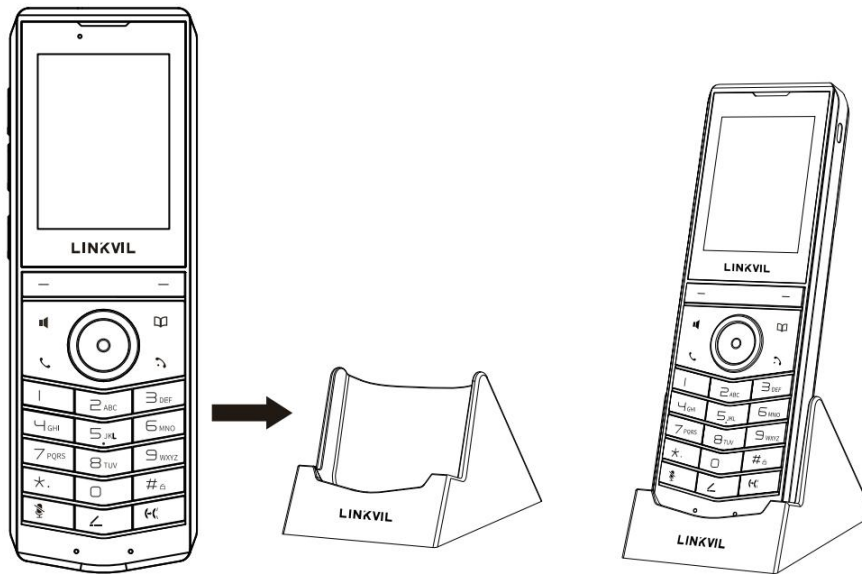

Picture 4 - Connect the charging base

Note:

1. Use Fanvil-supplied power adapter (5V/2A). A third-party power adapter may damage the handset.
2. Check the charging status on the top-right corner of the LCD screen.

5.4 Install the belt clip

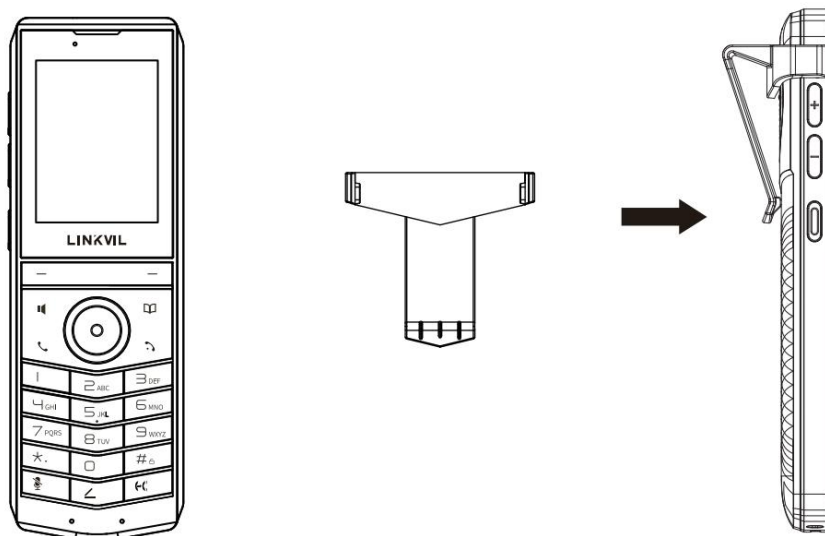

Picture 5 - Install the belt clip

6 Appendix Table



















6.1 Appendix I - Icon

Table 1 - Keypad Icons

Icon	Description
	Programmable keys, the default is PTT key, which can be set to function key/speed dial key, etc.
	Volume key, in standby or ringing mode: increase or decrease ringtone volume In call mode: increase or decrease the headset, handset, and hands-free volume
	Soft keys
	Up, down, left, right navigation keys, and OK key By default, the functions of each key during standby: Up key: Call history DSS Key Down key: status DSS Key Left key: Enter the DSS Key Page1 settings page Right key: Enter the DSS Key Page2 settings page OK key: Long press to restore factory settings, press the [OK] key to enter the menu when the device is in standby mode..
	Return to the homepage; Hang up the call; Entering sleep mode; Exit sleep mode Long press to power on/off
	Dialing; Switching call channels
	Phone book keyboard
	Hands-free key, enable/disable the hands-free channel
	Mute key, turn on/off mute
	DSS Key, can be set to different functions
	Call transfer key, during a call can transfer the call to another number

Table 2 - Status Prompt and Notification Icons

Screen Icon	Description
-------------	-------------

	In hands-free mode
	In headset mode
	In handset mode
	Mute activated
	Silent mode
	Call is on hold
	Auto-answering activated
	Call forward activated
	Do not disturb activated (Red)
	SIP hotspot activated
	VPN activated
	Bluetooth device paired connection
	Voice quality level of call
	Keypad locked
	Forward call(s)
	Missed call(s)
	Received call(s)
	Dialed call(s)

	Wireless network connected
	Wireless network disconnected
	Wireless network failure

6.2 Appendix II - Keyboard character query table

Table 3 - Look-up Table of Characters

Mode Icon	Text Mode	Key key	Characters Of Each Press
	Numeric	1	1
		2	2
		3	3
		4	4
		5	5
		6	6
		7	7
		8	8
		9	9
		0	0
		*	*.:@[],+_-='?\"';()<>{}#
#	Switch input method		
	Lower Case Alphabets	1	@:;()<>[]{}
		2	a b c
		3	d e f
		4	g h i
		5	j k l
		6	m n o
		7	p q r s
		8	t u v
		9	w x y z
		0	(space)
		*	.,*/+:-_='?\" #^!&\$\$%
#	Switch input method		
		1	@:;()<>[]{}

	Upper Case Alphabets	2	A B C
		3	D E F
		4	G H I
		5	J K L
		6	M N O
		7	P Q R S
		8	T U V
		9	W Z Y X
		0	(space)
		*	.,*/+.-:'?\" #^!&\$%
		#	Switch input method
	Mixed type input	1	1
		2	2 a b c A B C
		3	3 d e f D E F
		4	4 g h I G H I
		5	5 j k l J K L
		6	6 m n o M N O
		7	7 p q r s P Q R S
		8	8 t u v T U V
		9	9 w z y x W Z Y X
		0	0
		*	.*/@[],+._='?\" ;()<>{}# ^!&\$%
#	Switch input method		

6.3 Appendix III - LED Definition

Table 4 - Status Indicator LED State

Type	LED Light	State
Status Indicator	Yellow On	Charging
	Green On	Fully Charged
	Red and Yellow Blinking alternately	Low Battery/Abnormal charging
	Yellow Breathing Blinking	Missed calls or unread messages
	Yellow Blinking Quickly	Ringling

7 Introduction to the User

7.1 Instruction of Keypad

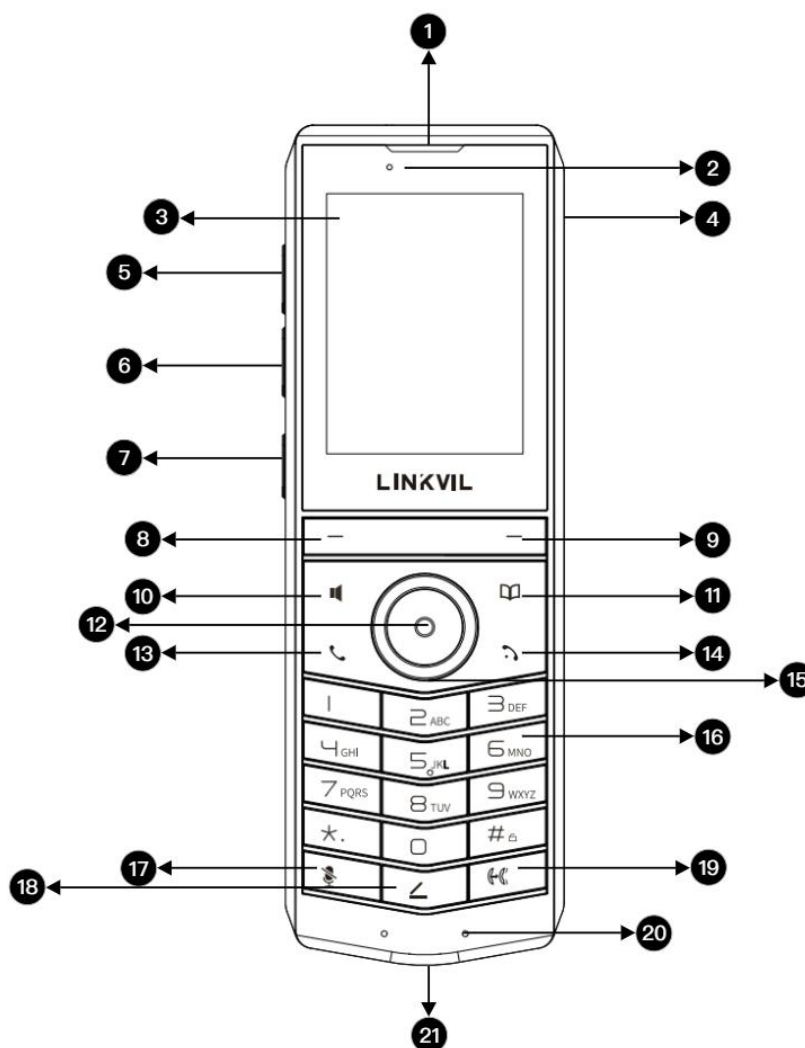

Picture 6 - W620W key layout

Table 5 - Instruction of Keypad of W620W

Index	Key Name	Description
①	Earpiece	Play sound when talking in handset mode.
②	Status indicator	Indicates the status of the device during calls and charging.
③	Screen	Display information and users complete interaction through physical keys.
④	Belt clamping hole	The position for installing the belt clip.
⑤	Volume Key +	In standby mode, on the ringing and ringing configuration interface, press this key to increase the volume of the ringtone;

		On the call or volume adjustment interface, press this key to increase the volume.
⑥	Volume Key -	In standby mode, on the ringing and ringing configuration interface, press this key to decrease the volume of the ringtone; Press this key to decrease the volume on the call or tone/brightness adjustment interface.
⑦	PTT key	Before configuration, short/long press to enter the function key setting interface and configure the required functions; After configuration, press to implement the corresponding function.
⑧	Soft key	These two keys provide corresponding menu functions displayed on the screen. This key is designated as DSS Key on the handset's standby interface.
⑨	Soft key	These two keys provide corresponding menu functions displayed on the screen. This key is designated as CallLog Key on the handset's standby interface.
⑩	Hands-free	Users can press this key to turn on the audio channel of the hands-free speaker.
⑪	Phonebook	By pressing the "PhoneBook" key, users can enter the device book interface and select a contact person to make a call.
⑫	OK key	It is equivalent to the confirmation software key by default, press it to enter the menu when the device is in standby mode..
⑬	Off-hook key	Dialing; Switch call channels.
⑭	On-hook key/Power	Return to the homepage; Hang up the call; Enter sleep mode; Exit sleep mode; Long press to enable/restart.
⑮	Navigation key	On some settings and text editing pages, users can press the left/right/up/down navigation keys to change options or move the cursor left/right/up/down in the screen list. Users can configure different functions for navigation keys on the Manager website.
⑯	Keypad	These 12 standard keys provide standard device key functions. At the same time, long pressing certain keys can trigger the provision of special functions. Lone press [#] key to lock the device (enable keyboard lock configuration).
⑰	Mute key	Press this key on the standby interface to mute the incoming call ringtone; Press this key on the call interface to mute the call.
⑱	DSS Key	Before configuration, short/long press to enter the DSS Key

		settings interface and configure the required functions; After configuration, press to implement the corresponding function.
⑱	Call transfer key	Press this key during a call can transfer the call to another number.
⑳	Microphone	Receive audio during calls.
㉑	Charging interface	Users can charge the handset here via the charging base or power adapter, and it also serves as a Type-C wired headphone jack.

7.2 Using Handset / Hands-free Speaker / Headset

■ Using Handset

For using the handset: Enter the number via the [Dial key], then press the [Dial key] / [#] key / [soft key-dial] to make the call; alternatively, press the [Dial key] after entering the number to initiate the call. When the speakerphone is on, press the [Dial key] to switch the device's audio channel.

■ Using Hands-free Speaker

For using the hands-free speaker: Either press the [Hands-free key] first then make the call, or enter the number first followed by pressing the [Hands-free key]. When the audio channel of the handset is active, press the [Hands-free key] to switch the device's audio channel.

■ Using Headset

In the factory settings, after inserting headset, the headset channel is turned on by default. When the headset is plugged in, the user can press the [dial key] to enter the number, and then press the [dial key] / [#] key; Or enter the number first and then press the [dial key]. The number will be dialed out and a call will be established through the headset channel. When the speaker is turned on, the user can switch the audio channel of the phone by pressing the [dial key].

7.3 Power on/off operation

Shutdown operation

- Shutdown: long press the [red on-hook key - Automatic shutdown when low battery: When the battery is about to run out, it will prompt "low battery". The phone automatically shuts down when the battery runs out.

Reboot

- Press [OK] key in standby mode to enter menu >> [Settings] >> [Reboot System], and select [OK] to reboot.
- long press the [red on-hook key 

Boot operation

- Long press the [red on-hook key] until the device turns on, or turn it on by connecting a charger.
- There is a setup wizard when the device is powered on under factory settings:
 - Select the language, time & date in sequence, then connect to the network.

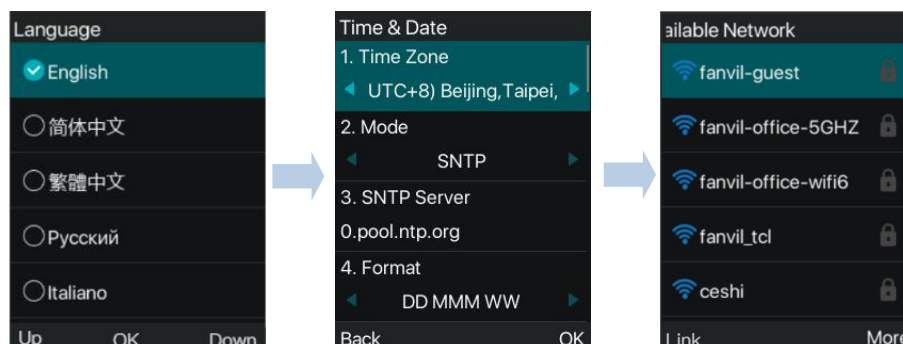

Picture 7 - W620W setup wizard

7.4 Connection Wi-Fi

Users can connect to Wi-Fi through the device or the web.

● Device side

1. Press [OK] key in standby mode to enter menu >> [WLAN], and enable the wireless network.
2. Select an available network and click to enter.
3. Select the corresponding Wi-Fi network from the Wi-Fi list, click [soft key-More] >> [Link], and enter the password.
4. After clicking [OK], the Wi-Fi connection is successful, and the corresponding Wi-Fi display will show ✓.

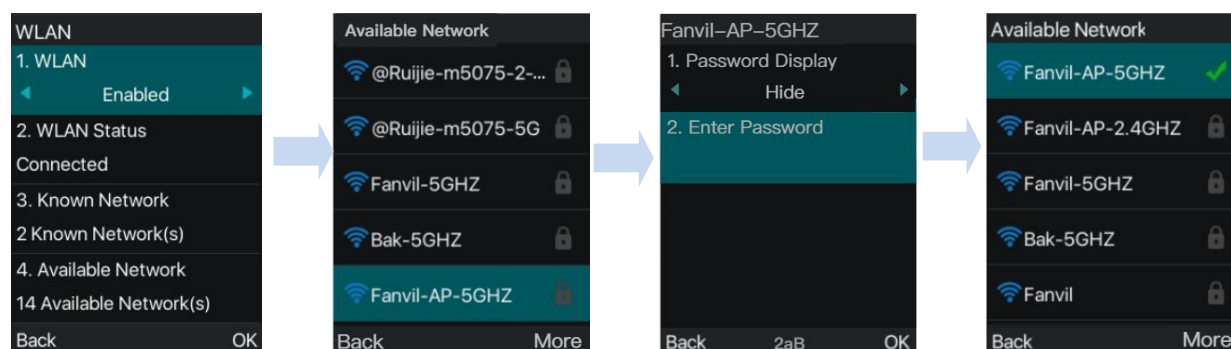

Picture 8 - Wi-Fi connection on the device side

● web side

Log in to the device web page, and go to [Network] >> [Wi-Fi Settings]. Select to enable Wi-Fi, and configure the corresponding SSID, username and password.

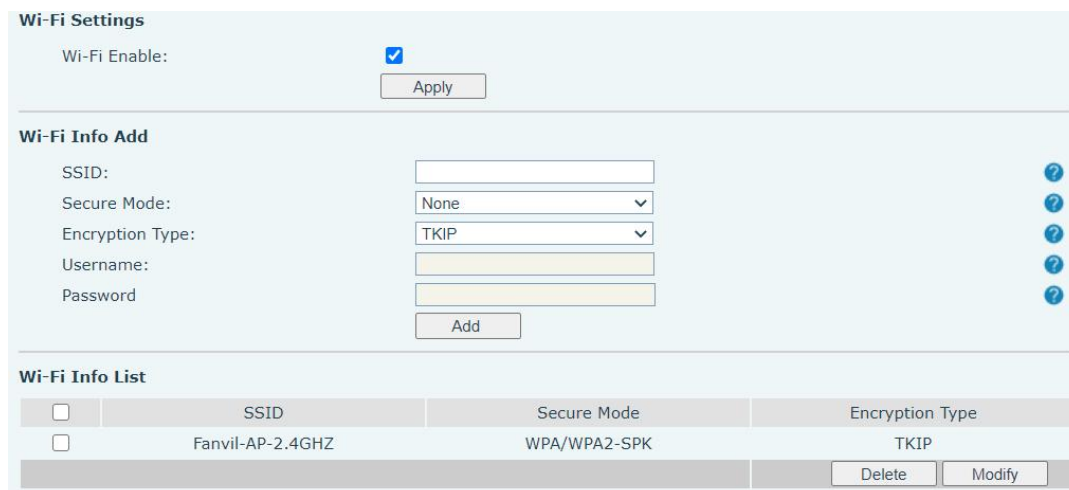

Picture 9 - Web connection Wi-Fi

● **Wi-Fi Quick Connection**

- On the handset's standby screen, press the [OK] key to enter the menu >> [WLAN] >> [Wi-Fi Quick Connection], click to [enter], and a QR code will be displayed.

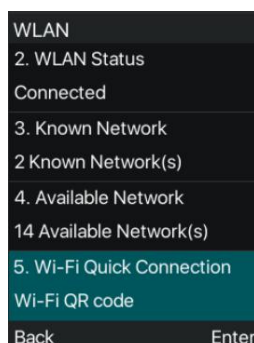

Picture 10 - Wi-Fi Quick Connection

- Scan the Wi-Fi QR code with your mobile phone, and you can select [Available Networks] or [Manually configure] in the Network Setup.
 - ◆ After selecting [Available Networks], the mobile phone will display the list of scanned WiFi networks. Users can select the network to connect to, enter the password, choose the network mode, and then connect to the network.

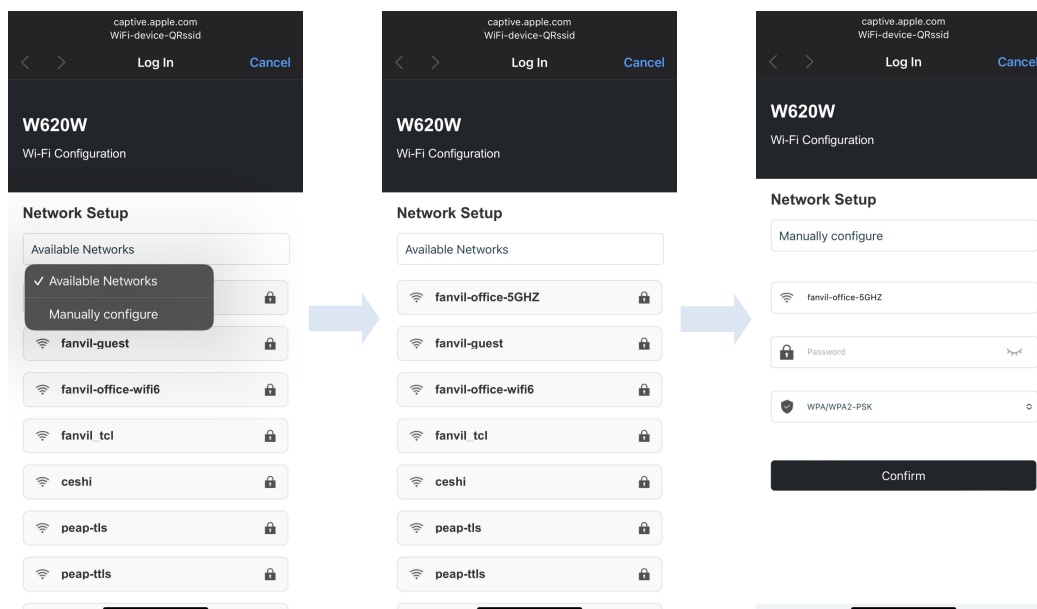

Picture 11 - Mobile phone scanning the Wi-Fi QR code - Available Networks

- ◆ After selecting [Manually configure], enter the Wi-Fi SSID, password, and security mode to connect to the network.

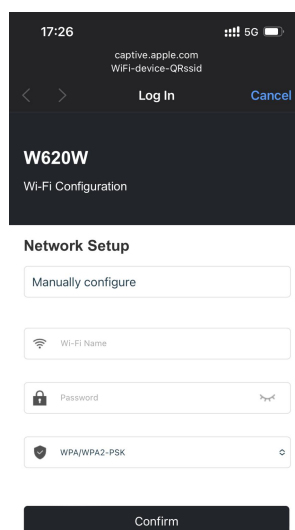

Picture 12 - Mobile phone scanning the Wi-Fi QR code - Manually configure

7.5 Connect to Bluetooth

W620W supports Bluetooth external line.

The method of connecting W620W to a Bluetooth device is as follows:

1. Press [OK] key in standby mode to enter menu >> [Basic] >> [Bluetooth Settings] to enable Bluetooth settings.
2. Select the [Paired Device] and press the [OK] key to scan for available Bluetooth around.
3. Select the corresponding Bluetooth device in the Bluetooth list, click [Link], the screen will prompt the

pairing key.

4. After the pairing confirmation is clicked on both the corresponding Bluetooth device and W620W, the Bluetooth connection is successful.

5. If the Bluetooth device is a mobile phone, W620W will prompt "Sync Phone Book Now?" After confirming, the phone contacts will be synchronized to the W620W contact directory, which can be viewed in [Menu] >> [Contacts] >> [Mobile Contacts].

6. After the Bluetooth is connected, the Bluetooth icon will be displayed after the Bluetooth device in the Bluetooth list. At the same time, the status bar of the standby interface will also display the Bluetooth icon.

Connect to Bluetooth

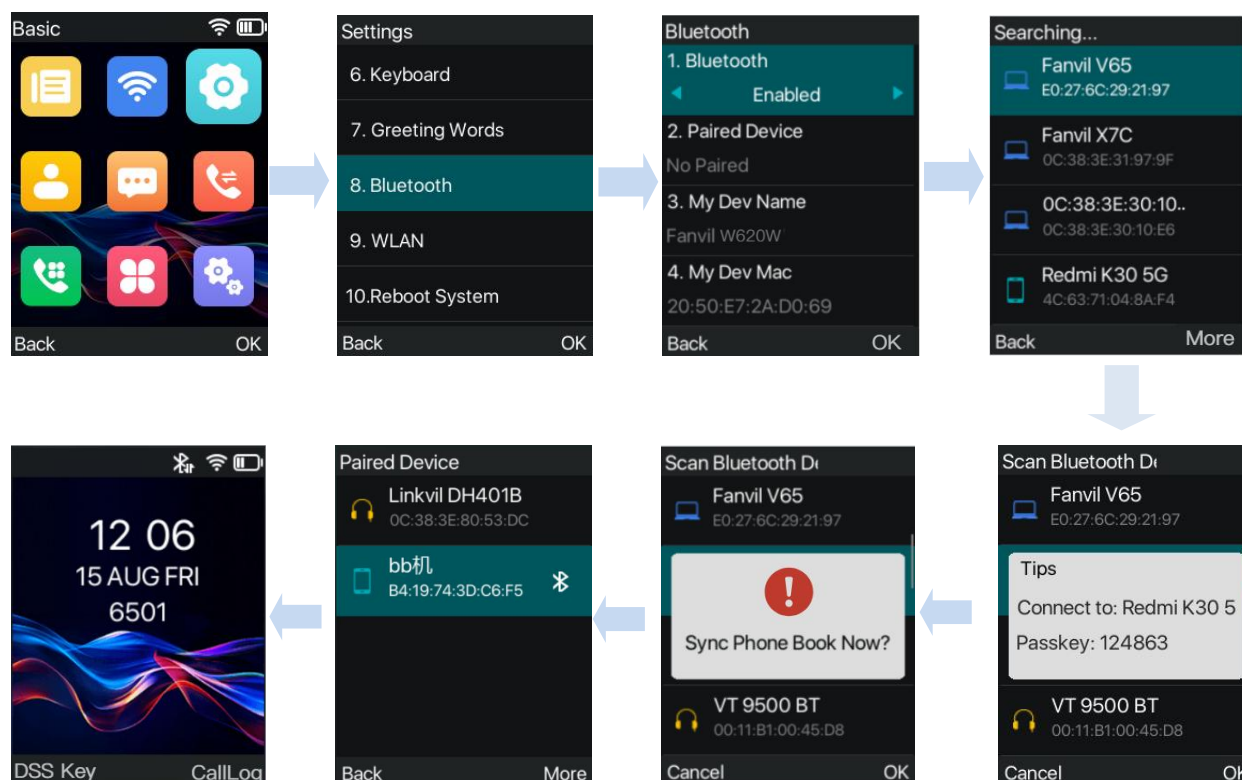

Picture 13 - Connect to Bluetooth

View Synced Mobile Contacts

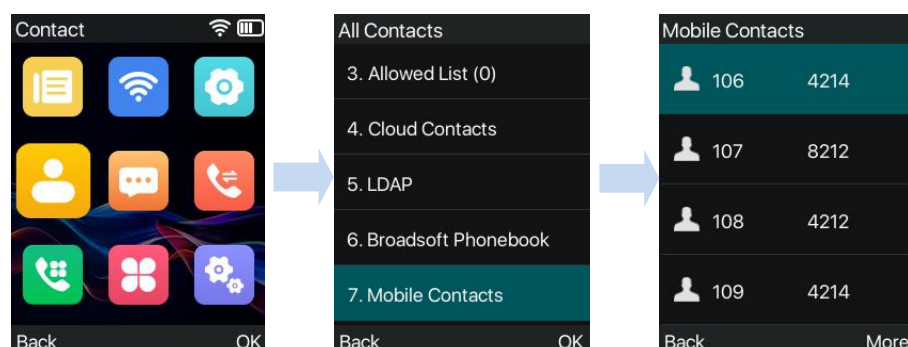

Picture 14 - Sync mobile phone contacts

7.6 Sleep State

Enter sleep state

- When the W620W is in no operation state, it enters the sleep state by default for 30 s.
- Standby press the [red hang up key ] to enter the sleep state.

Exit sleep state

- The phone automatically exits the sleep state when there is an incoming call.
- Press the phone key to exit the sleep state.

7.7 Standby Interface



Picture 15 - Screen Layout / Default Main Interface

The image above shows the default idle screen interface, which is the state of the user interface most of the time.

The status bar on the main screen displays the device status, information and data that can be edited (such as voice messages, missed calls, auto answer, do not disturb, locked status, network connection status, etc.).

The middle area shows the time and the registration status of the account.

The area below is the function menu keys, which is also the first layer of the function menu keys, through which the user can operate the phone.

The user can restore the phone to the default idle screen interface by pressing the [on-hook key 

Icon description is described in [6.1 Appendix I](#).

On some screens, the screen does not fully display due to too many items or too long text. They will be grouped together into a list with scroll icons. If the user sees a scroll icon, they can use the up/down navigation keys to scroll through the list.

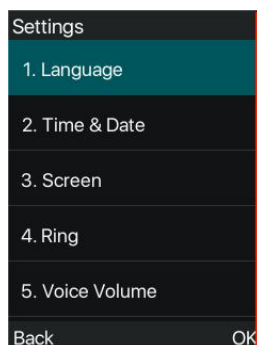

Picture 16 - Scroll Icon

7.8 Phone Status

The phone status includes the following information about the phone:

- Network Status:
 - IPv4 or IPv6 status
 - IP Address
 - Network mode
 - Wi-Fi Name
- The Phone Device Information:
 - Wi-Fi MAC address
 - Bluetooth MAC address
 - Phone Mode
 - Hardware Version number
 - Software Version number
 - Phone Storage (RAM and ROM)
 - System Running Time
- SIP Account Information:
 - SIP Account
 - SIP Account Status (register / uncommitted / trying / time out)
- TR069 Connect Status (Displays only in the phone interface state)

The user can view the phone status through the phone interface and the web interface.

- Phone interface: When the phone is in standby mode, press [OK] key in standby mode to enter menu >> [Status] and select the option to view the corresponding information, as shown in the figure:

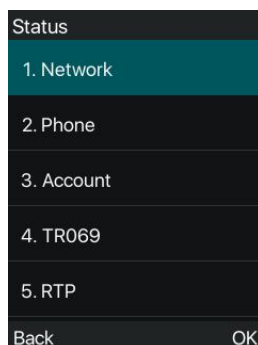

Picture 17 - The Phone status

- WEB interface: Refer to [7.9 Web management](#) to log in the phone page, enter the [System] >> [Information] page, and check the phone status, as shown in the figure:

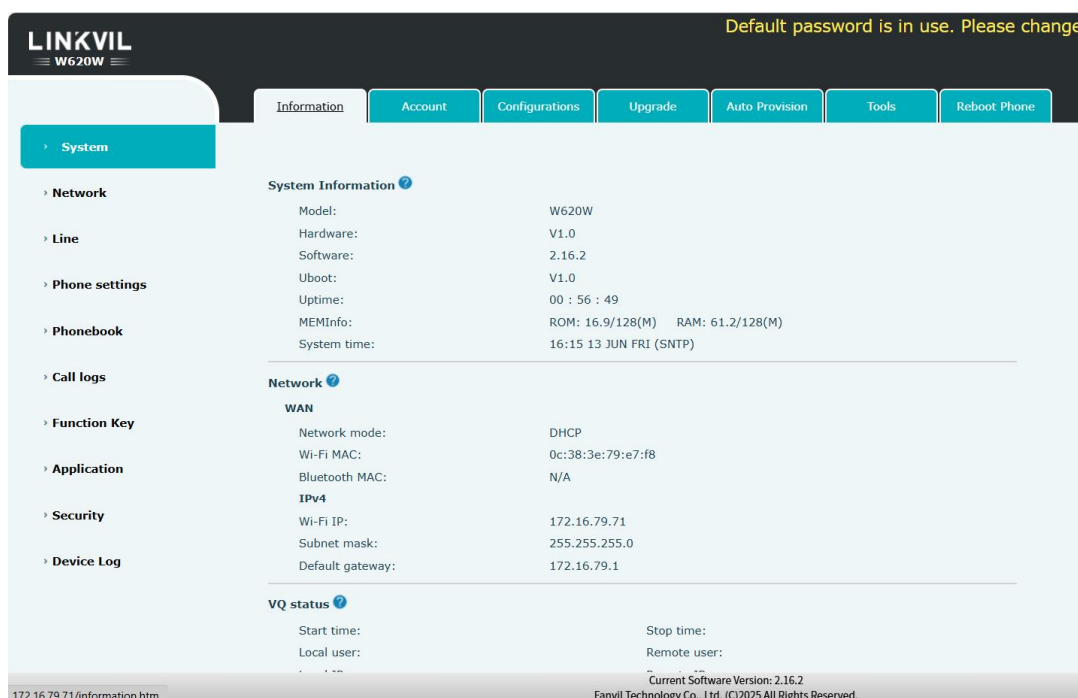

Picture 18 - WEB phone status

7.9 Web Management

Phone can be configured and managed on the web page of the phone. The user needs to enter the IP address of the phone in the browser and open the web page of the phone firstly. The user can check the IP address of the phone by pressing [OK] key in standby mode to enter menu >> [Status].

Open the browser, enter the phone IP, log in to the phone web page, the first thing to see is the phone landing page.



Picture 19 - Landing page

Users must correctly enter the user name and password to log in to the web page. **The default user name and password are "admin"**. For the specific details of the operation page, please refer to [11Web Configurations](#).

7.10 SIP Configurations

A line must be configured properly to be able to provide telephone service. The line configuration is like a virtualized SIM card on a mobile phone which stores the service provider and the account information used for registration and authentication. When the device is applied with the configuration, it will register the device to the service provider with the server's address and user's authentication as stored in the configurations.

The user can conduct line configuration on the interface of the phone or the web page, and input the corresponding information at the registered address, registered user name, registered password, SIP user and registered port respectively, which are provided by the SIP server administrator.

- Phone interface: To manually configure a line, the user can press the line key for a long time, or press [OK] key in standby mode to enter menu >> [Advanced] >> [Accounts] >> [Line n] configuration, click OK to save the configuration.

NOTICE! User must enter correct PIN code to be able to System to edit line configuration. (The default PIN is 123)

The parameters and screens are listed in below pictures,.

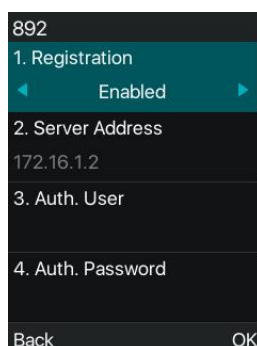

Picture 20 - Phone line SIP address and account information

- WEB interface: After logging into the phone page, enter [Line] >> [SIP] and select SIP for configuration, click apply to complete registration after configuration, as shown below:

LINKVIL W620W Default password is in use. Please change

SIP SIP Hotspot Dial Plan Action Plan Basic Settings RTCP-XR

- System
- Network
- Line**
- Phone settings
- Phonebook
- Call logs
- Function Key
- Application
- Security
- Device Log

Line: 802001@SIP1

Register Settings >>

Line Status: Registered	Activate: <input checked="" type="checkbox"/>
Username: 802001	Authentication User: 802001
Display name:	Authentication Password:
Realm: fanvil.com	Server Name:

SIP Server 1:	SIP Server 2:
Server Address: 172.16.1.97	Server Address:
Server Port: 7060	Server Port: 5060
Transport Protocol: UDP	Transport Protocol: UDP
Registration Expiration: 3600 second(s)	Registration Expiration: 3600 second(s)
Proxy Server Address:	Backup Proxy Server Address:
Proxy Server Port: 5060	Backup Proxy Server Port: 5060
Proxy User:	
Proxy Password:	

Basic Settings >>

Codecs Settings >>

Advanced Settings >>

Current Software Version: 2.16.2
Fanvil Technology Co., Ltd. (C)2025 All Rights Reserved.

Picture 21 - Web SIP registration

8 Basic Function

8.1 Making Phone Calls

■ Default Line

The phone provides multiple SIP line services. If both lines are configured, user can make or receive phone calls on either line. If default line is configured by user, there will be a default line to be used for making outgoing call which is indicated on the intermediate area. Enable or disable default line, user can press [OK] to enter Menu >> [Features] >> [General] >> [Default Line] or configure from Web Interface ([Web] >> [Phone settings]>>[Features] >> [Basic Settings]).



Picture 22 - Default line

■ Dialing Methods

User can dial a number by,

- Entering the number directly
- Selecting a phone number from local contacts (Refer to [10.2.1 Local Contact](#))
- Selecting a phone number from cloud contacts (Refer to [10.2.3 Cloud Contact](#))
- Selecting a phone number from call logs (Refer to [10.3 Call Log](#))
- Redialing the last dialed number

■ Dialing Number then Opening Audio

To make a phone call, user can firstly dial a number by one of the above methods. When the dialed number is completed, user can press [Dial] key on the soft-menu, or press hand-free key, or user can press the dial key to call out with specified line.

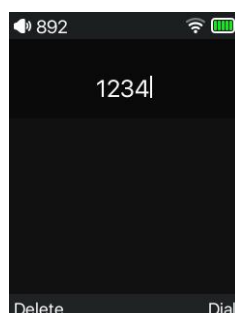

Picture 23 - Enable voice channel dialing

■ **Opening Audio then Dialing the Number**

Another alternative is the traditional way to firstly open the audio channel by lifting the handset, and then press the dial key  or hands-free key, dial the number with one of the above methods. When completing the number dial, user can press [soft key-Dial] key / [OK] key / [dial key] to call out.

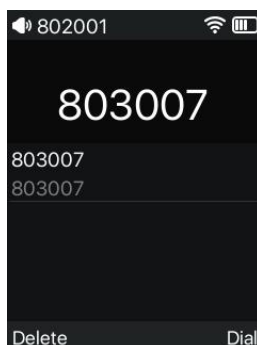

Picture 24 - Open the voice channel and dial the number

■ **Cancel Call**

When making a call, the user can press the [soft key-End] or [Hang-up key] to close the voice channel.

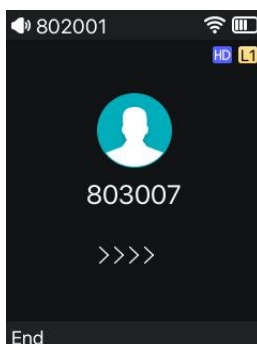

Picture 25 - Call number

8.2 Answering Calls

When the idle device receives an incoming call, the below incoming call appears on the screen.

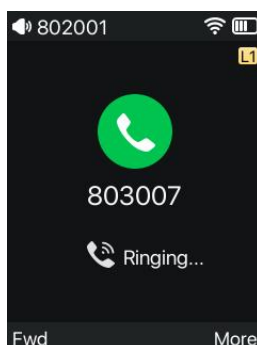

Picture 26 - Answering calls

User can answer the call by turning on the handset/headset/hands-free channel by pressing the [dial key] / [hands-free key]. To reject an incoming call, the user should press the [hang up key].

8.2.1 Talking

When the call is connected, user will see a talking mode screen as the following figure.

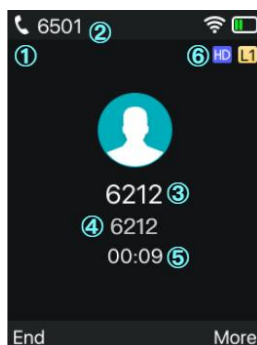

Picture 27 - Talking interface

Table 6 - Talking mode

Number	Name	Description
①	Voice channel	The icon shows the voice channel mode being used.
②	Default line	The line currently used by the phone.
③	Call-to-end name	The name of the person on the other end of the call.
④	Call-to-end number	The number of the person on the other end of the call.
④	Call duration	The duration of a call after it has been established.
⑤	Speech quality	Displays the current voice quality of the call.

8.2.2 Make / Receive Second Call

The phone can support multiple calls. When there is already a call established, user can still answer another incoming call on either lines or make a second call on either lines.

■ Second Incoming Call

When there is another incoming call during talking a phone call, this call will be waiting for user to answer. User will see the call message in the middle of current screen. The device will not be ringing but playing call waiting tone in the audio channel of the current call and the LED will be flashing in orange. User can accept or reject the call as same as normal incoming call. When the waiting call is answered, the first call will be held on automatically.

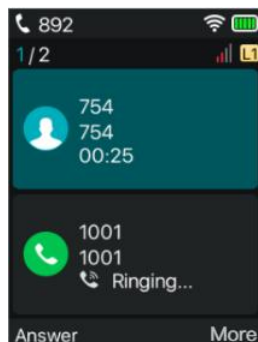

Picture 28 - The second call interface

■ **Second Outgoing Call**

To make a second call, User can press [More] >> [New Call] / [Transfer] / [Conf] or the physical key-[Call transfer] to dial the second call. Then dial the number the same way as making a phone call. Another alternative for making second call is to press DSS Keys or dial out from the configured Keys (BLF/Speed Dial). When the user is making a second call with the above methods, the first call could be held on manually or will be held on automatically at second dial.

■ **Switching between Two Calls**

When there are two calls established, user will see a dual calls screen as the following figure.

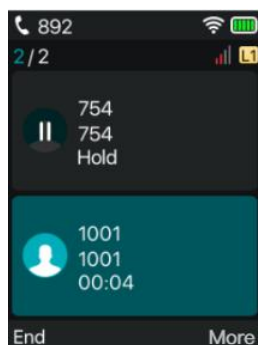

Picture 29 - Two way calling

User can press up/down navigator keys to switch screen page, and switch call focus by pressing [More] >> [Resume].

■ **Ending One Call**

User may hang up the current talking call by closing the audio channel or press [End] key. The device will return to single call mode in holding state. Users can also resume the current call by pressing the [More] >> [Resume] key.

8.3 End of the Call

After the user finishes the call, the user can press the [hands-free key] or [soft key-End] to close the voice channel and end the call.

Note! When the phone is in the reserved state, the user must press the [soft key-Resume] to return to the call state, or put the receiver back and press the [hands-free key] to end the call.

8.4 Redial

W620W has no physical redial key, users can set the side function key as redial key when using. Setting method: In standby, press [OK] key in standby mode to enter menu >> [Basic] >> [Keyboard] >> [DSS Key Settings], select the DSS Key to be set, select the type of DSS Key for the type, and select Redial for the name of the DSS Key. You can set the name of the callback key in the name input box, and press the [OK] key to save.

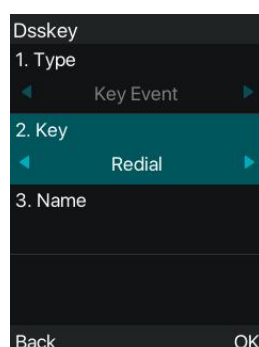

Picture 30 - Set redial DSS key

- Redial the last outgoing number:
When the phone is in standby mode, press the redial key and the phone will call out the last outgoing number.
- Call out any number with the redial key:
Enter the number, press the redial key, and the phone will call out the number on the dial.
- Press the redial key to enter the call record:
Log in the phone page, enter [Phone Settings] >> [Features] >> [Redial Settings], check Redial to enter the call record page, press the redial key when standby to enter the call record page, and press again to call out the current located number.

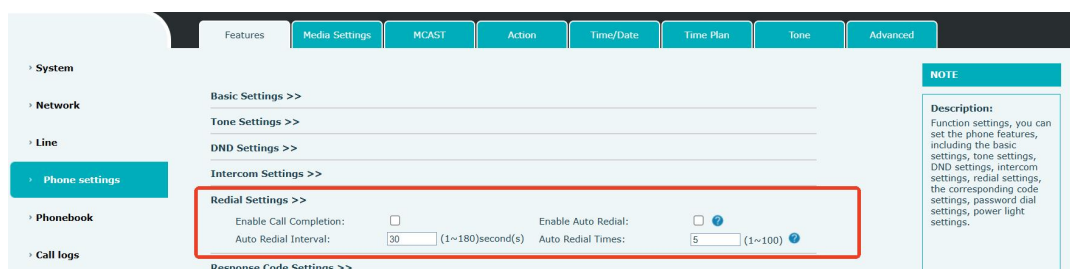

Picture 31 - Redial set

8.5 Dial-up Query

The phone is defaulted to turn on the dial-up inquiry function, dial-out, enter one or more numbers. The

dial interface will automatically match the call records, contacts in the number list. Use the navigation key and up and down keys to select the number, press the [Dial] key to call out.

8.6 Auto-Answering

User may turn on the auto-answering mode on the device and any incoming call will be automatically answered. The auto-answering can be enabled on line basis.

The user can start the automatic answer function in the phone interface or the web page interface.

- **Phone interface:**

Press [OK] key in standby mode to enter menu >> [Features] >> [Auto Answer];

Select the line, use the left/right navigation key to turn on/off the auto answer option, and set the auto answer time. The default auto answer time are 5 seconds.

After completion, press [OK] key to save;

The icon in the upper right corner of the screen  indicates that auto answer is enabled.

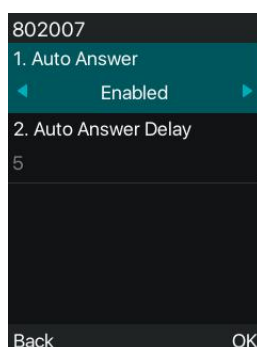

Picture 32 - Line 1 enables auto-answering



Picture 33 - The line has enabled auto-answering

- **WEB interface:**

Log in the phone page, enter [Line] >> [SIP], select [SIP] >> [Basic settings], start auto-answering, and click apply after setting the auto answering time.

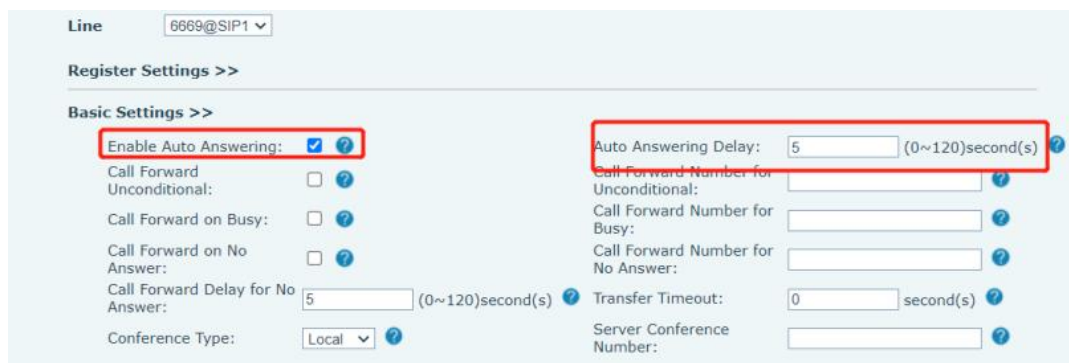

Picture 34 - Web page to start auto-answering

8.7 Callback

The user can dial back the number of the last call. If there is no call history, press the [Callback] key and the phone will say "can't process".

- Set the callback key through the phone interface:

Under standby, press [OK] key to enter menu >> [Basic] >> [Keyboard] >> [DSS Key Settings] or the physical key [DSS Key]. Choose [Call Back] function, input the callback key name, press [OK] key to save.

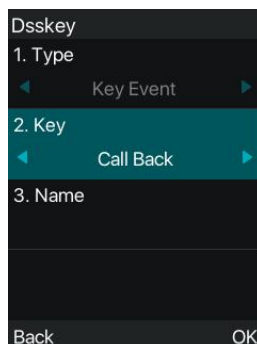

Picture 35 - Set the callback key on the phone

- Set the callback key through the web interface:

Log in the phone page, enter the [Function Key] >> [Function Key Settings], select the function Key, set the type as the function Key, and set the subtype as the callback, as shown in the figure:

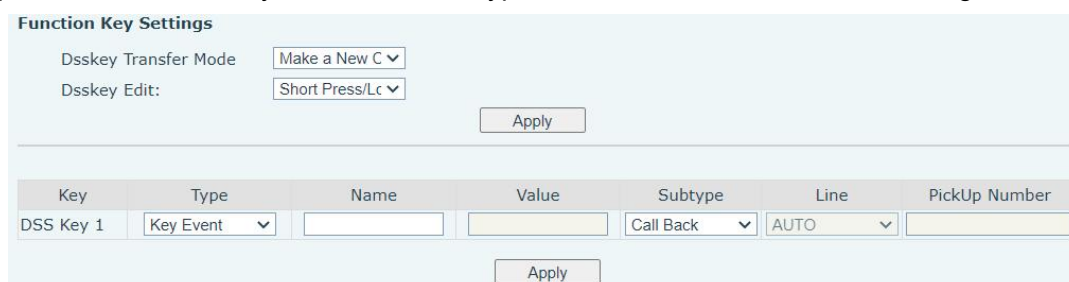

Picture 36 - Set the callback key on the web page

8.8 Mute

You can turn on mute mode during a call and turn off the microphone so that the local voice is not heard. Normally, mute mode is automatically turned off at the end of a call. You can also turn on mute on any screen (such as the free screen) and mute the ringtone automatically when there is an incoming call.

Mute mode can be turned on in all call modes (handset, headsets or hands-free).

8.8.1 Mute the Call

- Press [More] >> [Mute] or the physical key [Mute key] during a call. Mute icon is displayed in the call interface, as shown in the figure:

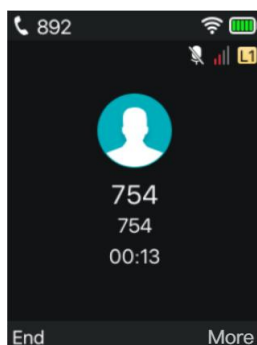

Picture 37 - Mute the call

- Cancel mute: Press [More] >> [Mute] or the physical key [Mute key] again. The mute icon is no longer displayed in the call screen.

8.8.2 Ringing Mute

Users can set shortcut key function key as mute key: Under standby, press [OK] key to enter menu >> [Basic] >> [Keyboard] >> [DSS Key Settings] or the physical key [DSS Key]. Choose [Mute] function, input the callback key name, press [OK] key to save.

Mute can also be turned on/off with the [volume up and down keys] or the physical key [Mute key] .

Turn on ringing mute

- Press the [DSS Key-Mute] or the physical key [Mute key] when the phone is in standby mode.
- Press the [volume down key] to mute when the phone is in standby

The top right corner of the phone shows the bell mute icon , when there is an incoming call, the phone will display the incoming call interface but will not ring.



Picture 38 - Ringing mute

Cancel ring tone mute:

- Press the [Mute] function key or the physical key [Mute key] when the phone is in standby mode.
- Press the [volume up key] to mute when the phone is in standby.

The mute icon  is no longer displayed in the upper right corner after canceling.

8.9 Call Hold/Resume

The user can press the [More] >> [Hold] to maintain the current call, and this key will become the [More] >>[Resume], and the user can press the [More] >> [Resume] to restore the call.

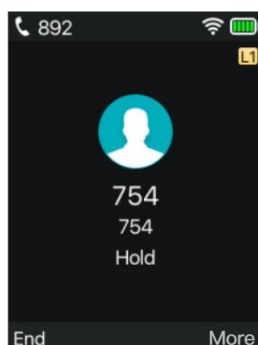

Picture 39 - Call hold interface

8.10 DND

User may enable Do-Not-Disturb (DND) feature on the device to reject incoming calls (including call waiting). The DND can be enabled on line basis.

Phone user interface enable/disable DND

- Enable/Disable phone all lines DND, the methods as the following:
 - 1) Press [OK] key in standby mode to enter menu >> [Features] >> [DND] to enter the [DND] edit page.
 - 2) Use the left/right navigation keys to select the mode as [Phone], and press the [OK] key to save after completion.
 - 3) The user will see the DND icon in the status bar, and the device has enabled Do Not Disturb Mode.

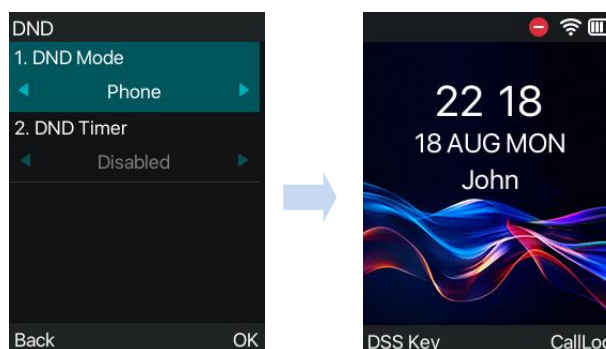

Picture 40 - Enable DND

- If the user wants to enable/disable the uninterrupted function on a specific line, the user can set the methods as the following:
 - 1) Press [OK] key in standby mode to enter Menu >> [Features] >> [DND] to enter the [DND] edit page.
 - 2) Use the left/right navigation keys to select the line to adjust the DND mode and status, and press the [OK] key to save after completion.
 - 3) The user will see the DND icon in the status bar, and the sip-line has enabled the mode of "DND".

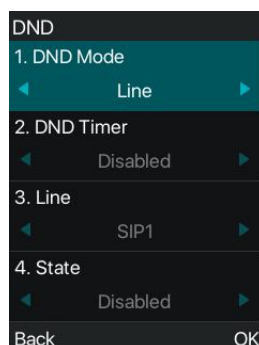

Picture 41 - DND setting interface

- The user can also use the DND timer. After the setting, the DND function will automatically turn on and the DND icon will turn red when ringing.

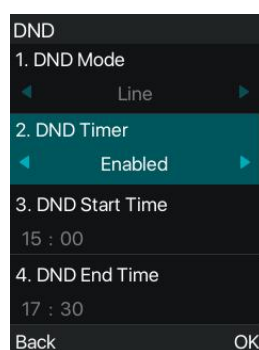

Picture 42 - DND timer

WEB interface enable/disable DND

- After logging into the web page, enter [Phone setting] >> [Features] >> [DND settings], set the DND type (off, phone, line), and DND timing function.

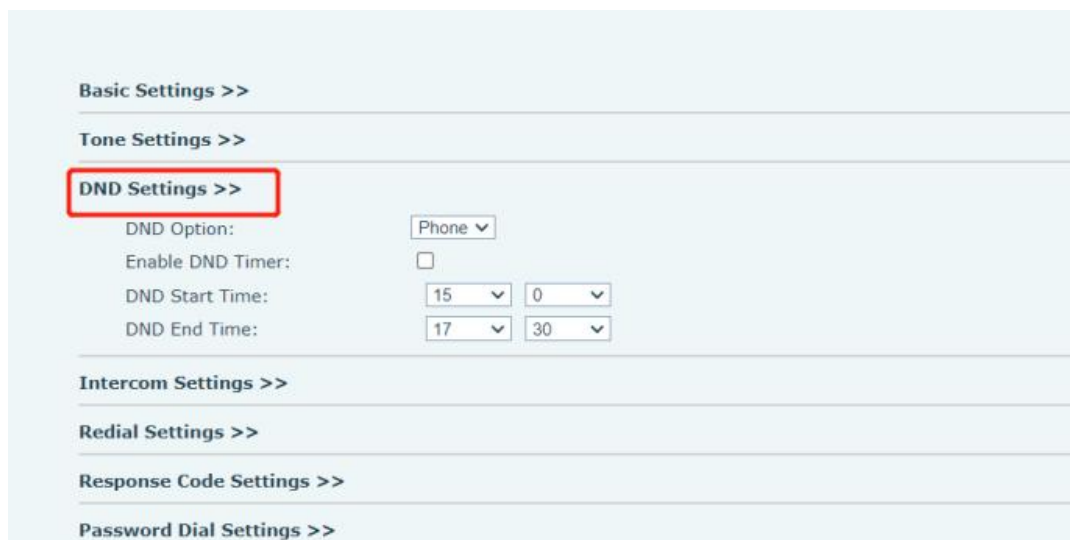

Picture 43 - DND Settings

The user turns on the DND for a specific route on the web page: Enter [Line] >> [SIP], select a [Line] >> [Basic settings], and enable DND.

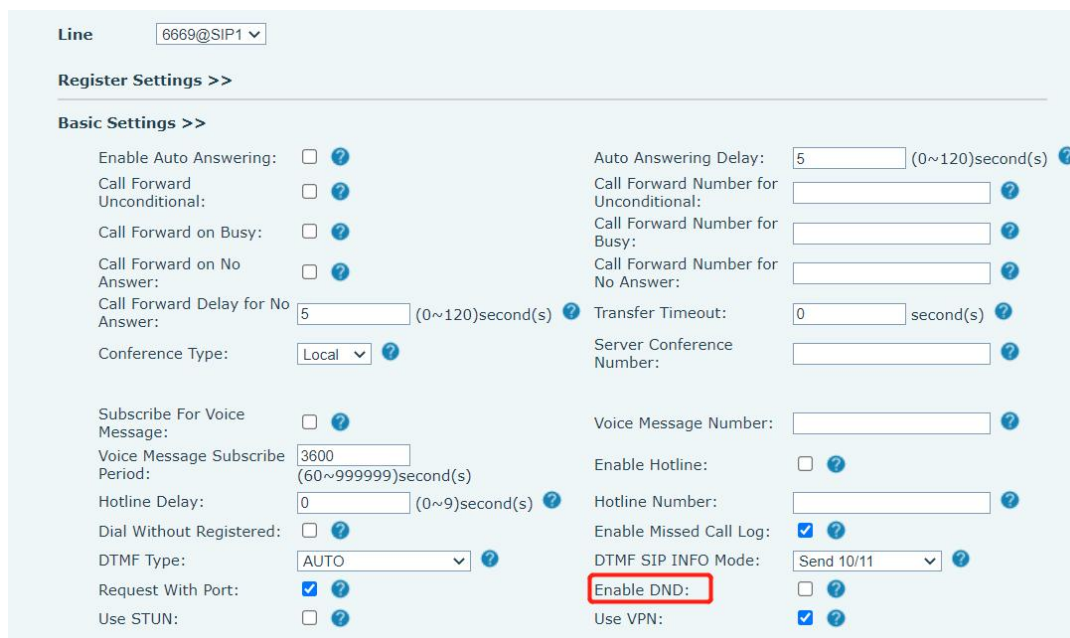

Picture 44 - Line DND

8.11 Call Forward

Call forward is also known as 'Call Divert' which is to divert the incoming call to a specific number based

on the conditions and configurations. User can configure the call forward settings of each line. There are three types,

- **Unconditional Call Forward** – Forward any incoming call to the configured number.
- **Call Forward on Busy** – When user is busy, the incoming call will be forwarded to the configured number.
- **Call Forward on No Answer** – When user does not answer the incoming call after the configured delay time, the incoming call will be forwarded to the configured number.

Phone interface: Default standby mode

- 1) Press [OK] key in standby mode to enter menu >> [Features] >> [Call Forward], select the line by up/down navigation key, press [OK] key to set call forward.

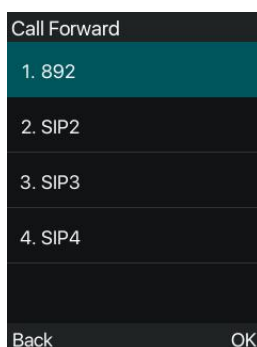

Picture 45 - Select the line to set up call forwarding

- 2) Select the call forward type by pressing the up/down navigation key. Click [OK] to configure call forwarding and delay time.

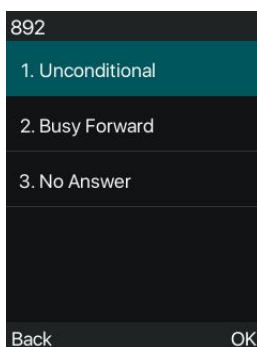

Picture 46 - Select call forward type

- 3) Select enable/disable by pressing the left/right navigation key.

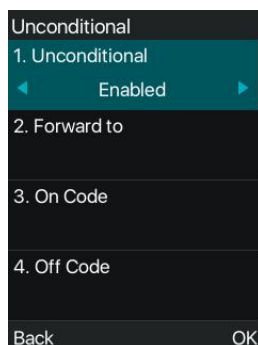

Picture 47 - Enable call forwarding and configure the call forwarding number

4) Browse the parameters set by the up/down navigation key and enter the required information. When finished, press the [OK] key to save the changes.

WEB interface: Enter [Line] >> [SIP], Select a [Line] >> [Basic settings], and set the type, number and time of forward forwarding.

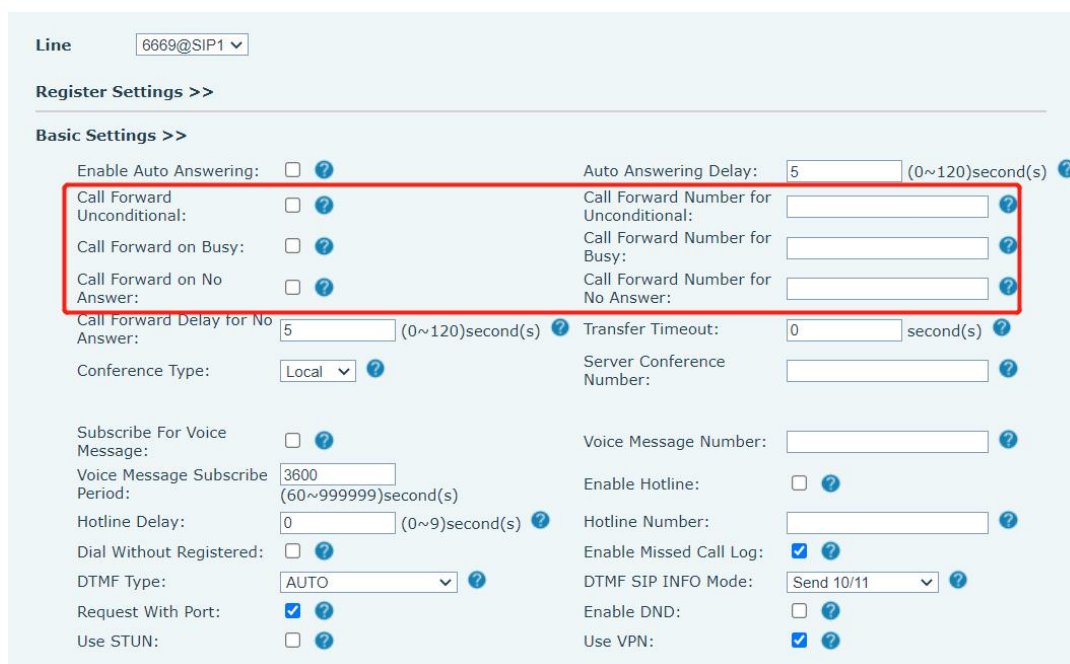

Picture 48 - Set call forward

8.12 Call Transfer

When the user is talking with a remote party and wish to transfer the call to another remote party, there are three ways to transfer the call, blind transfer, attended transfer and Semi-Attended transfer.

- Blind transfer: No need to negotiate with the other side, directly transfer the call to the other side.
- Semi-Attended transfer: When you hear the ring back, transfer the call to the other party.
- Attended transfer: When the caller answers the call, transfer the call to the other party.

Note! For more transfer Settings, please refer to [12.7 Line >> Dial Plan](#)

8.12.1 Blind transfer

During the call, the user can press [soft key-Xfer] or the physical key [Call transfer key] , enter the number to transfer or press the [Phonebook] key or the [CallLog] key to select the number, press the [transfer key] again to a third party. After the third party rings, the phone will show that the transfer is successful and hang up.

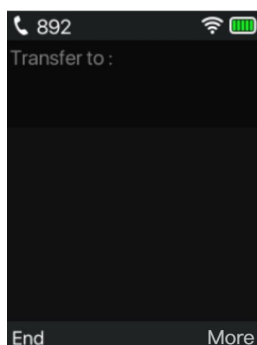

Picture 49 - Transfer interface

8.12.2 Semi-Attended transfer

During the call, the user can press [soft key-Xfer] / [Call transfer key] to input the number to be transferred or press the [Phonebook] key or the [CallLog] key to select the number, and then press the [dial key]. When the third party is not answered, press the transfer on the call interface to make the semi-attendance transfer or press the [end] key to cancel the semi-attendance transfer.

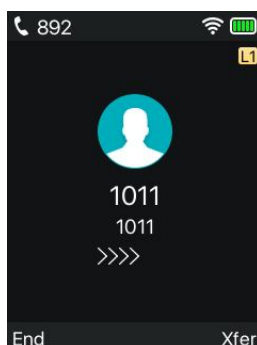

Picture 50 - Semi-Attended transfer

8.12.3 Attended transfer

Attendance transfer is also known as "courtesy mode", which is to transfer the call by calling the other party and waiting for the other party to answer the call.

The same procedure to calling. In dual call mode, press [soft key-Xfer] / [Call transfer key] to transfer the first call to the second call.

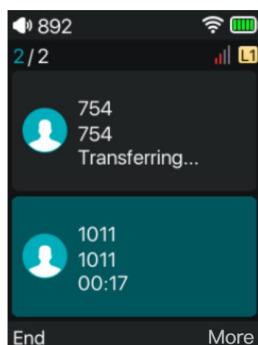

Picture 51 - Attended transfer

8.13 Call Waiting

- Enable call waiting: new calls can be accepted during a call.
- Disable call waiting: new calls will be automatically rejected and a busy tone will be prompted.
- Enable call waiting tone: when you receive a new call on the line, the tone will beep.

The user can enable/disable the call waiting function in the phone interface and the web interface.

- Phone interface: Press [OK] key in standby mode to enter menu >> [Features] >> [Call waiting], the navigation key and left/right key enable/disable call waiting and call waiting tone.

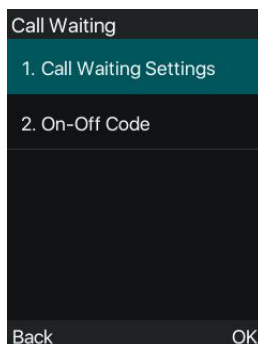

Picture 52 - Call waiting setting

WEB interface: Enter [Phone Settings] >> [Features] >> [Basic Settings], enable/disable call waiting and call waiting tone.

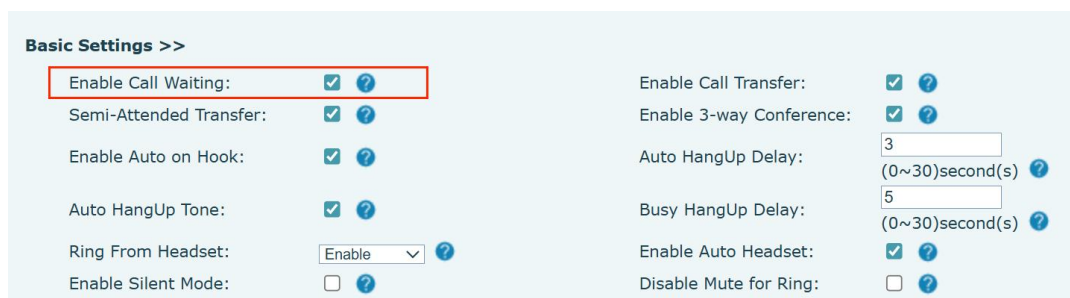

Picture 53 - Web call waiting setting

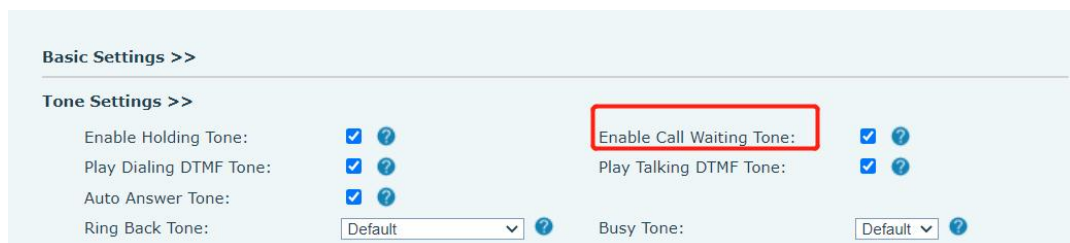

Picture 54 - Web call waiting tone setting

8.14 Conference

8.14.1 Local Conference

To conduct local conference, the user needs to log in the web page and enter [Line] >> [SIP] >> [Basic settings]. The meeting mode is set as local (the default is local mode), as shown in the figure:

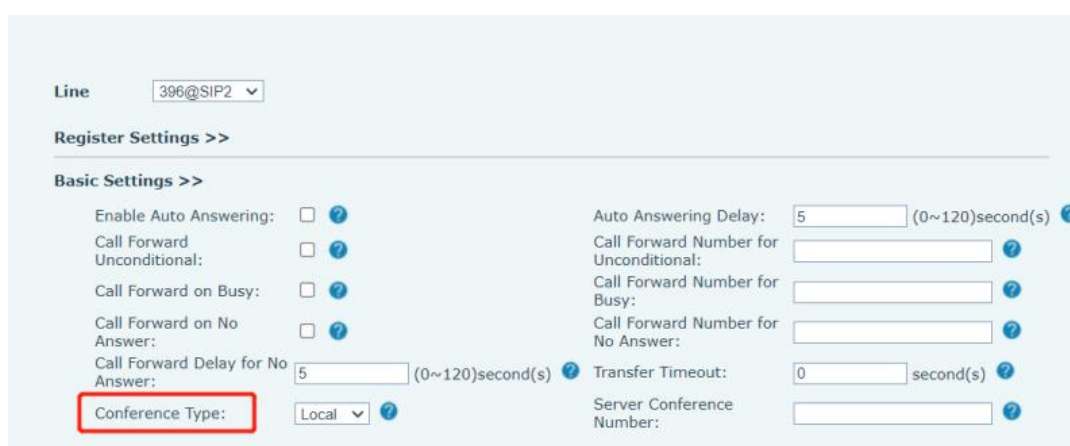

Picture 55 - Local conference setting

Two ways to create a local conference:

1) The device has two calls, press [soft key-More] >> [Conf] on the call interface, select another existing number when selecting the conference number, and press the [OK] key to establish a local 3-way conference as shown in the figure.

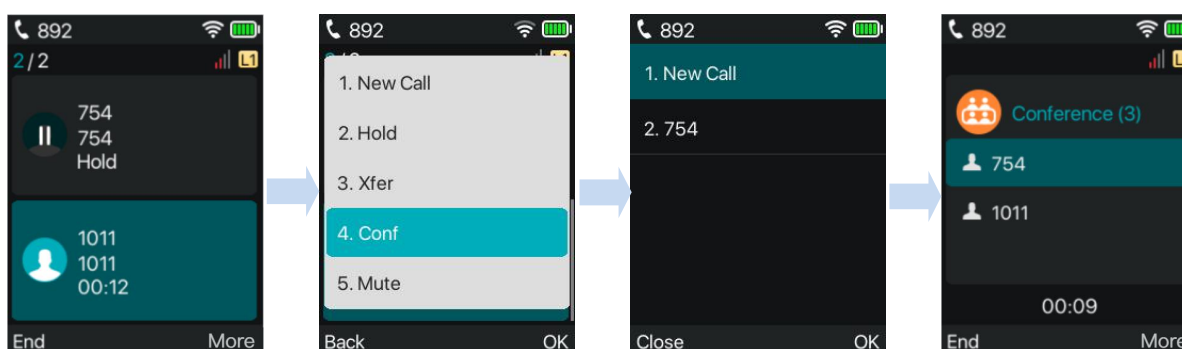

Picture 56 - Local conference (1)

2) There is a call on the device, press [soft key-More] >> [Conf] on the call interface, enter the number to join

the conference, and press [soft key-Dial]; after the opposite end answers, press the [conf] again to establish a local three-party conference. As shown in the figure:

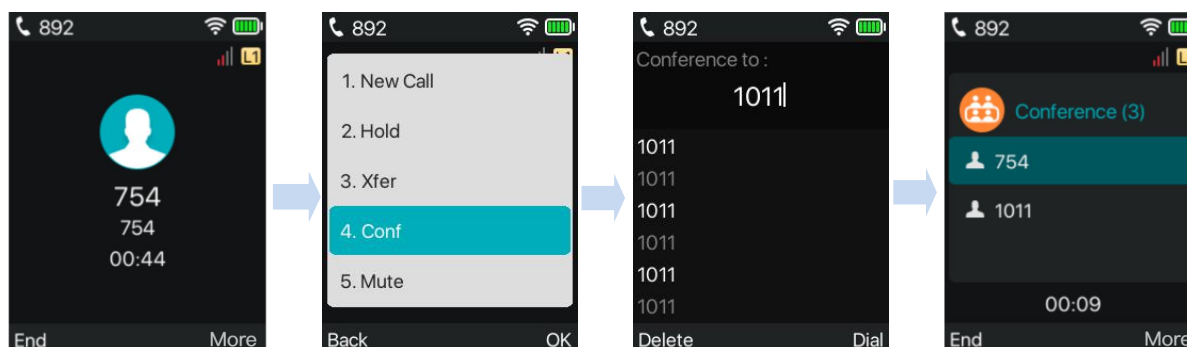

Picture 57 - Local conference (2)

Note: During a conference, press the [More] >> [Separate] key to separate the conference, and press the end key to end the call.

8.14.2 Network Conference

Users need server support for network conference.

Log in the web page, enter [Line] >> [SIP] >> [Basic settings], set the conference mode as server mode (default is local mode), set the server conference room number (please consult your system administrator), as shown in the figure:

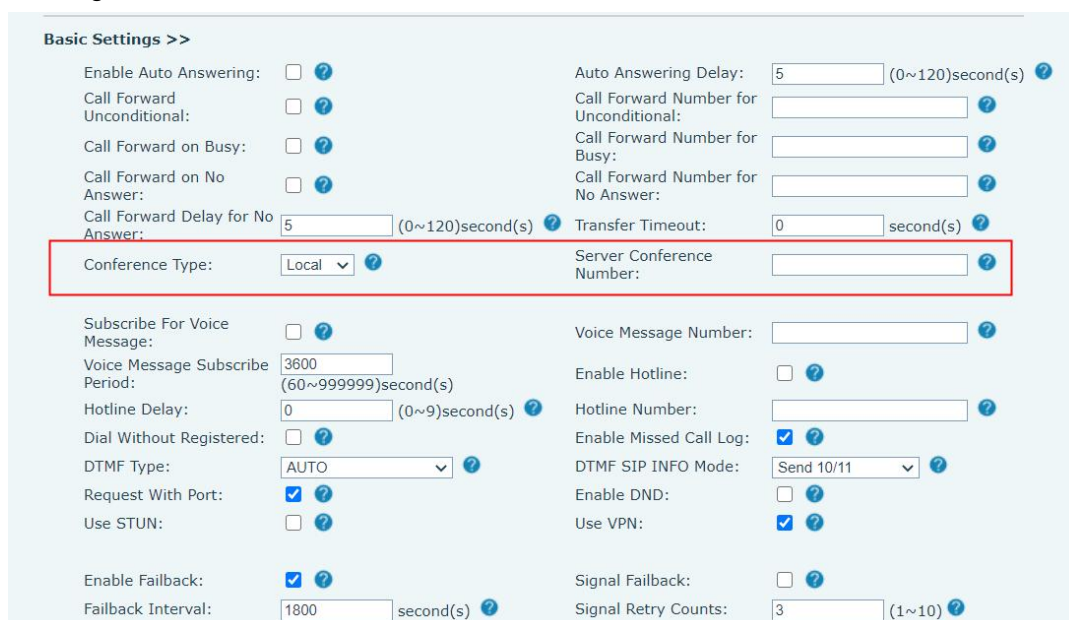

Picture 58 - Network conference

Method to join a network conference:

- Multi-way call number of network conference room and enter the password then all enter the conference room.
- The two phones have established common calls. Press the conference key to invite new members to the conference. Follow the voice prompt to operate.

Note: the upper limit of the number of participants in the network conference varies according to the server.

8.15 Anonymous Call

8.15.1 Anonymous Call

The phone can set up anonymous calls to hide the calling number and the calling name.

- Phone interface: press [OK] key in standby mode to enter menu >> [Advanced] >> [Accounts] >> [SIP Line] >> [Advanced].
- The default is none, which is off, and RFC3323 and RFC3325 are optional.
- Select any one to open the anonymous call.

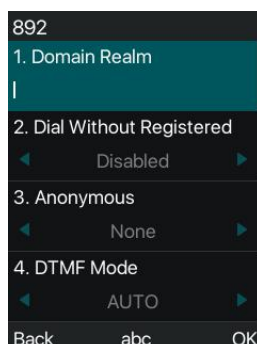

Picture 59 - Enable anonymous call

- On the web page [Line] >> [SIP] >> [System] can also open the mode of anonymous calls.
- Setting to enable anonymous calls also corresponds to the SIP line. That is, the setting under the SIP1 page can only take effect on the SIP1 line.

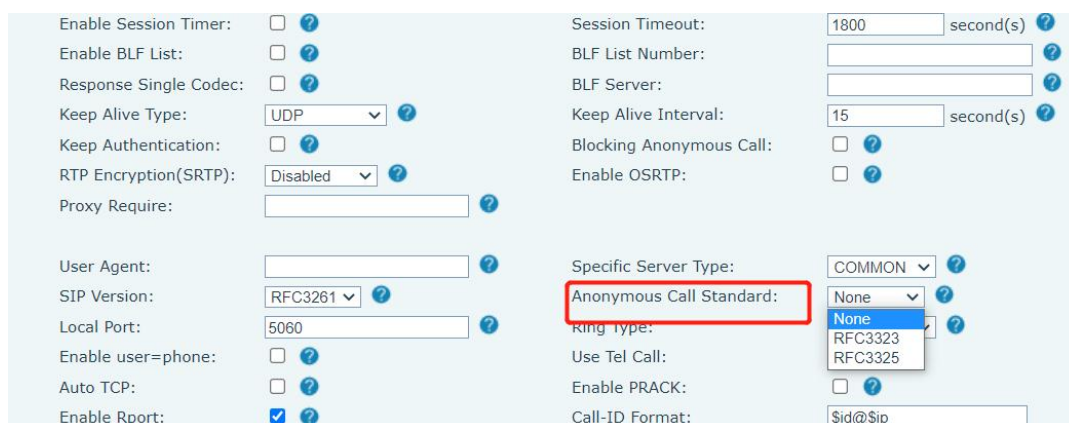

Picture 60 - Enable Anonymous web page call

The following is a transcript of an anonymous call received by the phone.

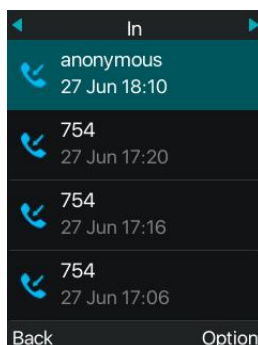

Picture 61 - Anonymous call log

8.15.2 Ban Anonymous Call

The device can be set to prohibit anonymous calls, that is anonymous calls to the number will be directly rejected.

- Phone interface: press [OK] key in standby mode to enter menu >> [Features] >> [Ban anonymous call], click to enter and all SIP lines will be displayed.
- Use navigation key-left/right to switch the SIP line and enable anonymous call.

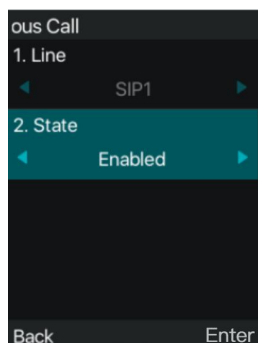

Picture 62 - Anonymous calls are not allowed on the phone

- On the web page [Line] >> [SIP] >> [System], also can disable anonymous calls.
- The setup to disable anonymous calls also corresponds to the SIP line. That is, the setting under the SIP1 page can only take effect on the SIP1 line.

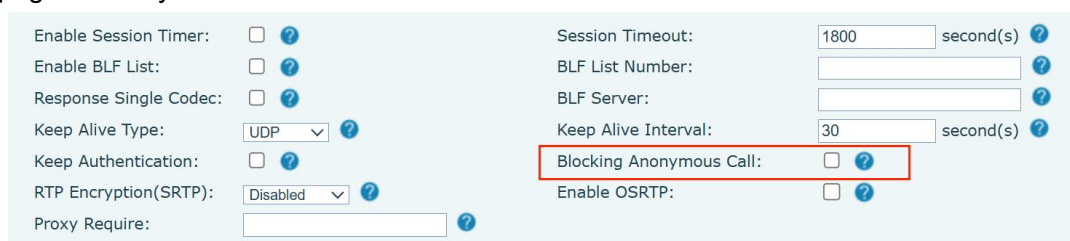

Picture 63 - Page Settings blocking anonymous call

8.16 Hotline

The device supports hotline dialing. After setting up the hotline dialing, directly pick up the handset, hands-free, headset, etc., and the phone will automatically call according to the hotline delay time.

- Press the [OK] key in the phone's standby mode to enter the menu >> [Features] >> [Advanced] >> [Hot Line], click to enter and all SIP lines will be displayed.
- Then set the hotline for each SIP line, which is off by default.
- Open the hotline, set the hotline number, set the delay time of the hotline.

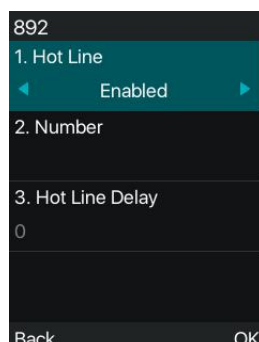

Picture 64 - Phone hotline setting interface

- On the website [Line] >> [SIP] >> [Basic Settings], can also set up a hotline.
- The setup hotline also corresponds to the SIP line. That is, the hotline set in the SIP1 web page can only be activated in the SIP1 line.

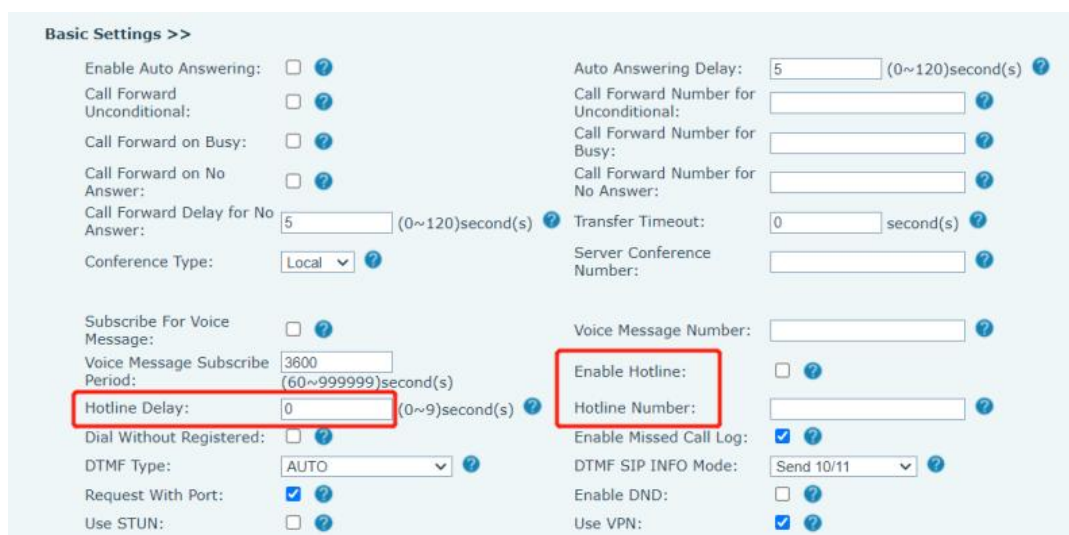

Picture 65 - Hotline set up on web page

8.17 Emergency Call

The emergency call function is used to set the corresponding emergency call number on the phone after enabling the keypad lock. You can also call emergency services when your phone is locked.

- 1) Configure the emergency call number: log in the phone page, enter the [Phone Settings] >> [Features]>> [Basic Settings] page, set up the emergency call code, if you need to set up more than one emergency call code, please use ", "to separate.

Allow IP Call:	<input checked="" type="checkbox"/>	P2P IP Prefix:	<input type="text"/>
Caller Name Priority:	LocalContact-NetContact-SIP DisplayName	Emergency Call Number:	110
Search path:	LDAP	LDAP Search:	LDAP 1
Caller Display Type:	Normal	Push XML Server:	<input type="text"/>
Restrict Active URI Source IP:	<input type="text"/>	Enable Multi Line:	<input checked="" type="checkbox"/>
Enable Pre-Dial:	<input checked="" type="checkbox"/>	Contact As Allowed List Type:	NONE
Line Display Format:	xxx@SIPn	SIP Notify:	Enable
Block XML When Call:	Enable	Auto Resume Current:	Disable
Call Number Filter:	<input type="text"/>	Ring Timeout:	120 (1~3600)second(s)
Call Timeout:	120 (1~3600)second(s)	Display BLF PickUp Popup:	<input type="checkbox"/>
Enable Push XML Auth:	<input type="checkbox"/>	Ring Type For BLF PickUp:	Splash
Play BLF PickUp Tone:	<input type="checkbox"/>	Enable Display To Info:	<input type="checkbox"/>
Ring Priority:	Priority		

Picture 66 - Set up an emergency call number

- 2) When the phone set the keyboard lock, you can call the emergency call number without unlocking, as shown in the figure:

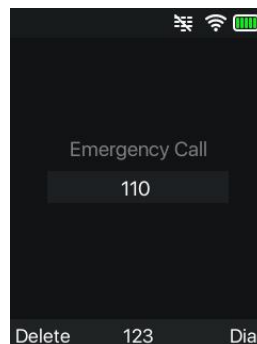

Picture 67 - Dial the emergency number

9 Advance Function

9.1 Video Preview

W620W supports video preview and video calls with a maximum video resolution of 4CIF, and the default value is CIF. When the video preview function is enabled, the W620W can preview the caller's video content before answering when another device initiates a video call to it.

Setting Method:

- Video preview for SIP lines: Access W620W device's web interface >> [Line] >> [SIP] >> [Advanced Settings], check to [enable preview], and select the preview mode.

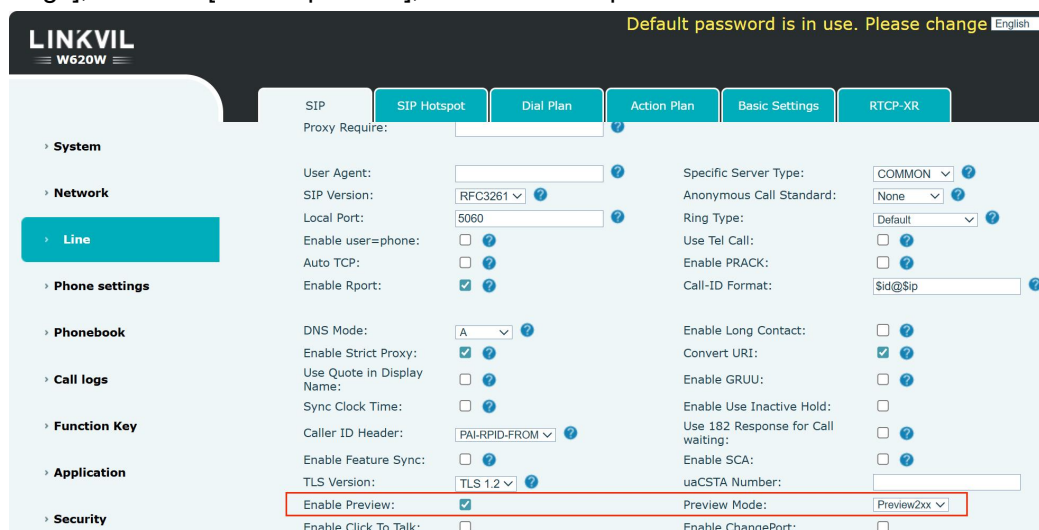

Picture 68 - Web interface settings for SIP line video preview

- Setting up video preview for IP calls: Access W620W device's web interface >> [Line] >> [Basic Settings] >> [SIP P2P Settings], check to [enable preview], and select the preview mode.

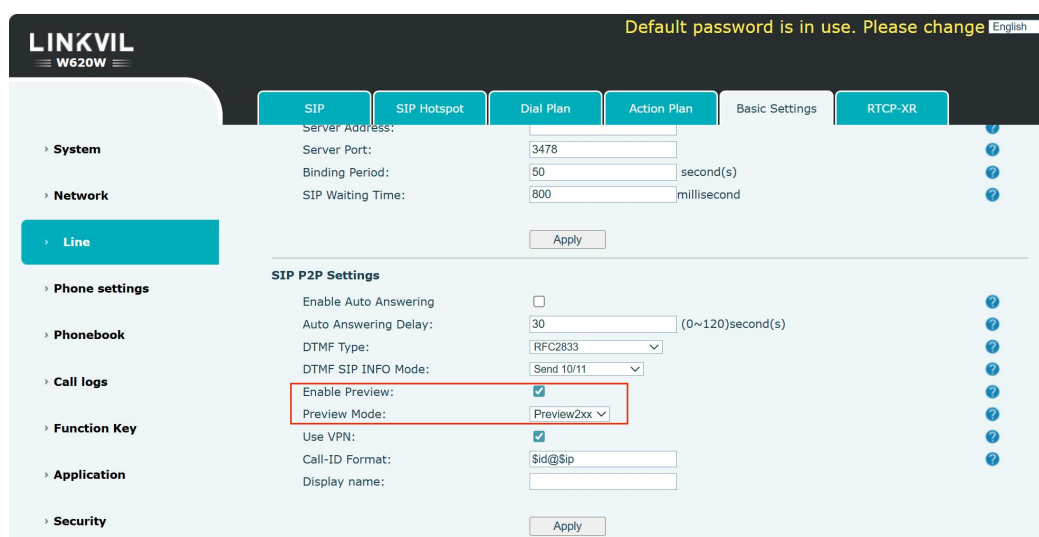

Picture 69 - Video preview settings for IP calls on the web interface

Preview Mode:

- Preview2xx: Default value. Preview is performed by replying with a 2XX message. During preview, the other end displays the call timing interface, while the local end displays the video preview interface, and the voice call is not connected.
- Preview18x: Preview is performed via 18X messages and requires SIP server support.

9.2 Video Call

After setting the value of [Default Ans Mode] / [Default Dial Mode] to [Video], when the device answers a call from or makes a call to a video-enabled device, the video interface of the other party will be displayed after the call is connected.

Setting method: Access W620W device's web interface >> [Phone settings] >> [Features] >> [Basic Settings]

- Default Ans Mode:
 - Video: Default value. When the device receives an incoming video call from the other party, it initiates a video call after answering.
 - Audio: When the device receives an incoming video call from the other party, it initiates a voice call after answering.
- Default Dial Mode:
 - Video: Call the other party's device in video mode. If the other party's device also answers in video mode, a video call will be initiated after the call is answered.
 - Audio: Default value. Call the other party's device in voice mode, and a voice call will be initiated after the call is answered.

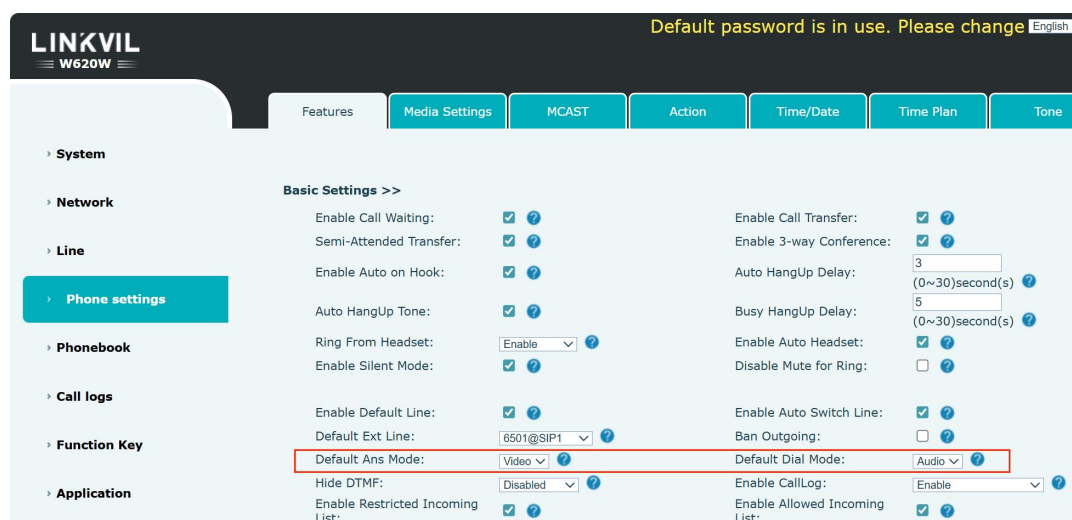

Picture 70 - Web interface settings for default ans/dial mode

- Video Display Mode

Setting method: Access W620W device's web interface >> **【Phone Settings】** >> **【Media Settings】** >> **【Media Settings】** >> **【Video Display Mode】**

- Aspect Ratio Crop: Current setting. Crops the image in equal proportion to enable full-screen video display with no distortion (default value).
- Fit: Compresses the original video in equal proportion and fills the blank areas with black, ensuring no distortion.
- Original Size: Displays the original video in full screen, which may result in stretching distortion.

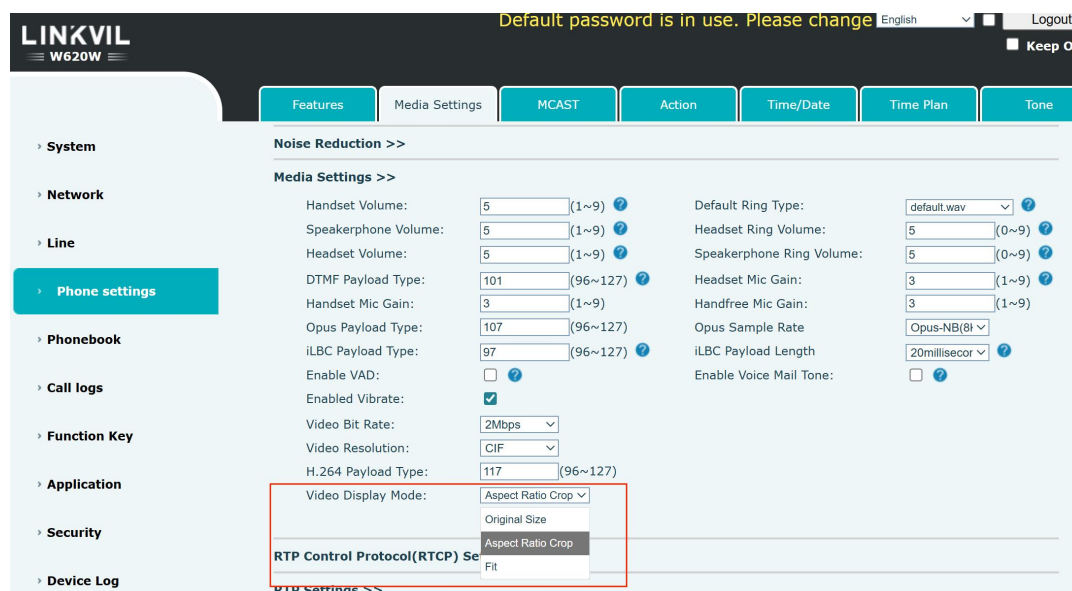

Picture 71 - Web interface settings for video display mode

9.3 One-Click to Open Door

The device supports one-touch door opening for Fanvil access control via function keys both in standby mode and during a call. W620W detects that the peer end complies with the number rules in the access control list, and dynamically displays [Soft key - Open], which is displayed on the far left by default.

9.3.1 Door Opening in Standby Mode

Setting Method: Set the function key type to URL >> Open Door, edit the value of the function key, and save:

- URL or IP: Set the IP address of the access control device.
- Username: Set the username for accessing the access control web interface.
- Password: Set the password for accessing the access control web interface.
- When setting via a configuration file or LCD, the value of the function key can be set to:
`http://[Username]:[Password]@[Access Control IP]/cgi-bin/ConfigManApp.com?key=F_LOCK&code=*[Access Control Password]`

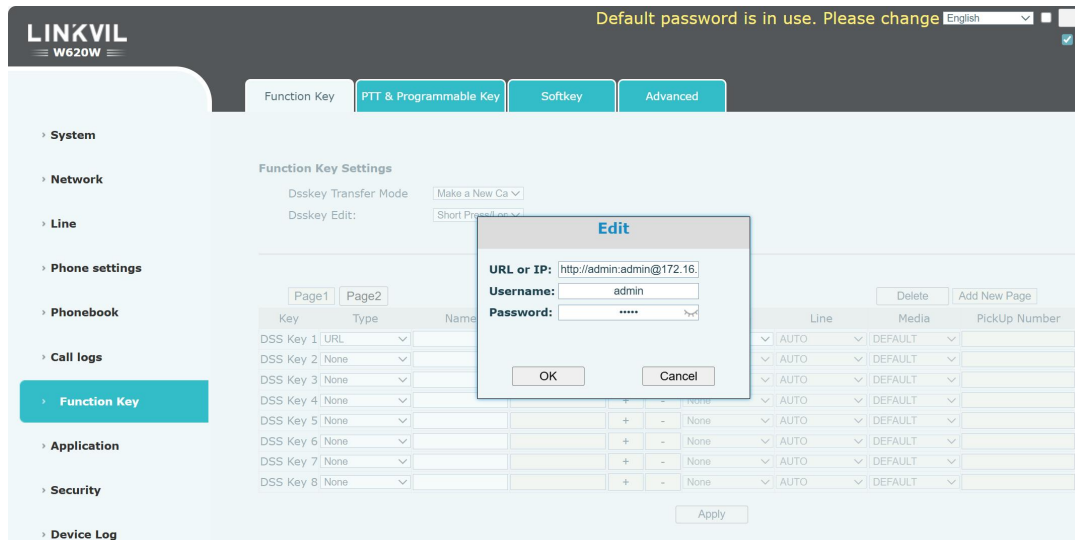

Picture 72 - Web interface settings for URL door opening

Operation: Press this [DSS Key] to open the door when in standby/call mode.

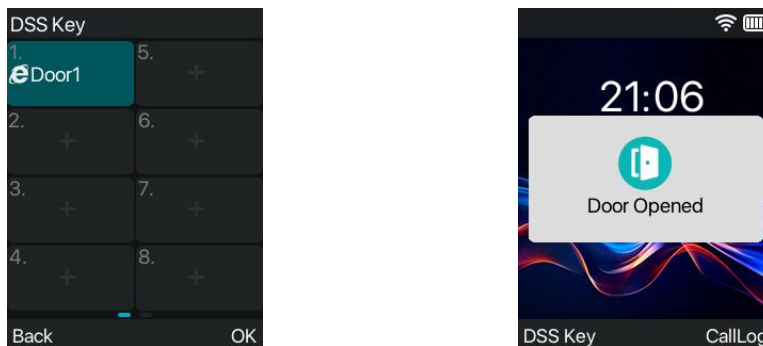

Picture 73 - Door opening in standby mode

9.3.2 Door Opening in Standby Mode

Setting Method: Access W620W device web page >> Function Key >> Softkey, select the display page as "Ringing", "Voice Call" or "Video Call", and move SoftDsskey2 (which has been set as the default Type of Open Door) to the "Selected Softkeys" area on the right.

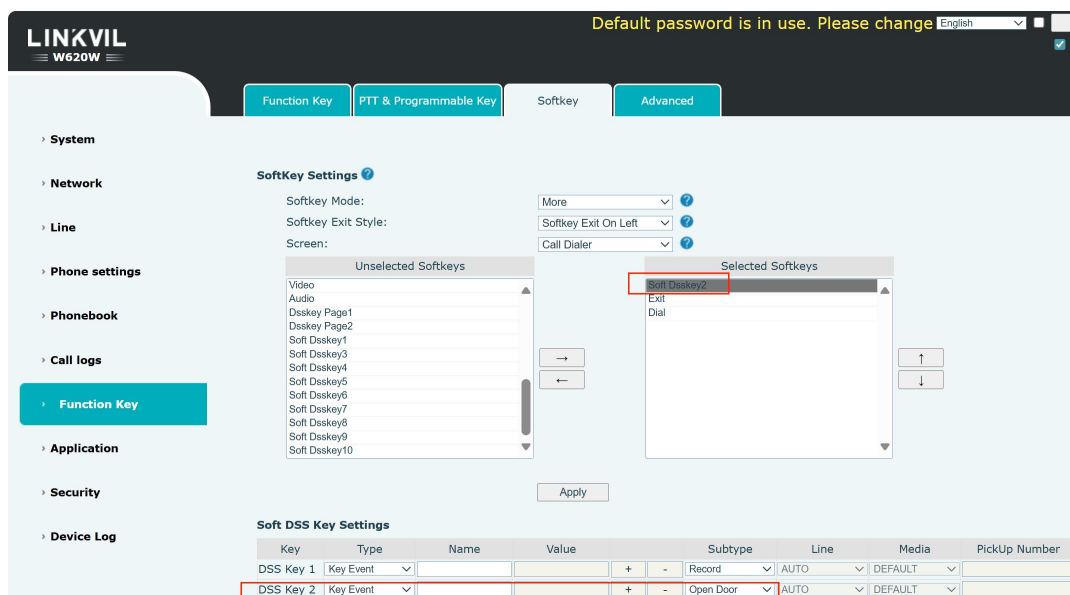

Picture 74 - Web interface settings for door-opening softkey

Operation: When there is an incoming call from the Fanvil access control device, press the [soft key-Open] on the W620W during ringing or a call to open the door with one touch.

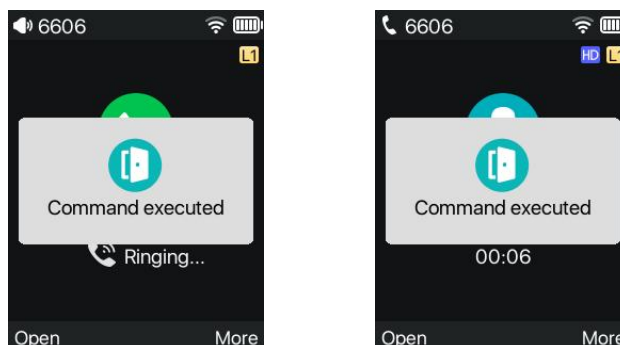

Picture 75 - Door opening via softkey on the handset

9.4 Record

The device supports recording during a call.

9.4.1 Server Record

When using the network server to record, it is necessary to open the recording in the phone web page [Application] >> [Manage recording]. The type is selected as network, and the address and port of the recording server are filled in and the voice coding is selected. The web is as follows:

Picture 76 - Web server recording

Note: to be used with Fanvil recording software.

9.4.2 SIP INFO Record

The phone is registered with a server that supports SIP INFO recording. After registering the account, check the recording module of [Application] >> [Record Setting] to open the recording, and the record type is SIP INFO.

Picture 77 - Web SIP info recording

9.5 Agent

Agent (Agent function) of the phone can be realized: when multiple people use a device for Agent services at different times, he or she can quickly register his or her SIP account on the same server. The Agent functions of the phone can be divided into Normal and Hotel Guest. The Hotel Guest mode requires server support.

Normal Mode:

Configure agent function: set a DSS Key as agent, press the function key or press [OK] key in the phone's standby mode to enter menu >> [Features] >> [Agent] to enter the agent page. The SIP server needs to be configured before the account can be configured.

Note: The password to enter the proxy configuration is the same as the menu password, the default is 123.

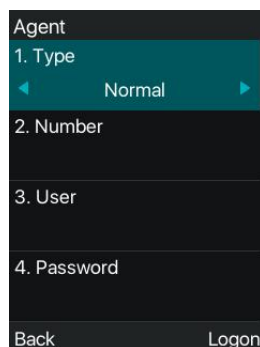

Picture 78 - Configure the agent account in normal mode

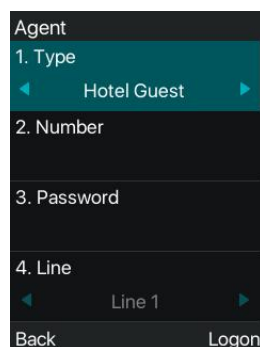

Picture 79 - Configure the proxy account-hotel Guest mode

Table 7 - Agency mode

Parameter	Description
Normal mode	
Number	Set the proxy account number.
User	Set the proxy account number to verify the user name.
Password	Set the proxy account number to verify the password.
Line	Select the SIP line.
Hotel Guest mode	
Number	Set the proxy account number.
User	Set the proxy account number to verify the user name.
Password	Set the proxy account number to verify the password.
Line	Select the SIP line.
CallLog	Users can choose to save all types, or delete.
Status	The user can select the status of the number, including Login, Logout, Unavailable, Available, and Wrap-up

Using agent functions:

- 1) When the phone has been configured on SIP server, fill in the correct number and user name password,

- click login and then the phone can be registered to the SIP server;
- 2) After registration, click logout and the phone can delete the user name and password, and log out of the SIP account.
 - 3) Click Unregister and the phone retains the user name and password, and logs out of the SIP account.

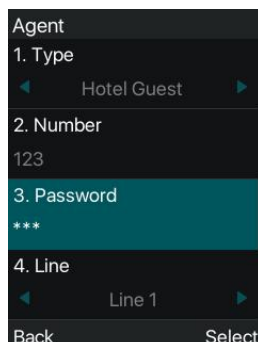

Picture 80 - Agent logon page

9.6 Intercom

When the Intercom is enabled, it can automatically receive calls from the intercom.

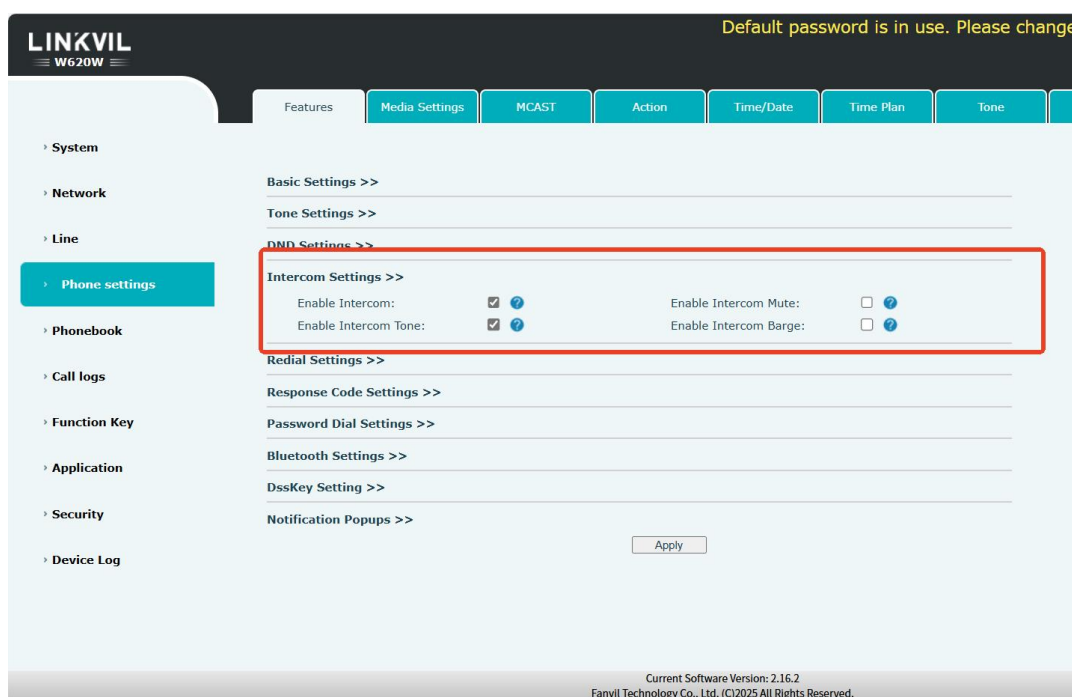

Picture 81 - Web Intercom configure

Table 8 - Intercom configure

Parameter	Description
Enable Intercom	When intercom is enabled, the device will accept the incoming call request with a SIP header of Alert-Info instruction to automatically answer the call after specific delay.
Enable Intercom	Enable mute mode during the intercom call.

Mute	
Enable Intercom Tone	If the incoming call is intercom call, the phone plays the intercom tone.
Enable Intercom Barge	Enable Intercom Barge by selecting it, the phone auto answers the intercom call during a call. If the current call is intercom call, the phone will reject the second intercom call.

9.7 MCAST

Using the multicast function, voice broadcasts can be easily and conveniently sent to all members within the multicast group. By setting the multicast key on the phone, the multicast RTP stream is sent to the pre-configured multicast address. By configuring the listening multicast address on the phone, the RTP stream of that multicast address is listened to and played.

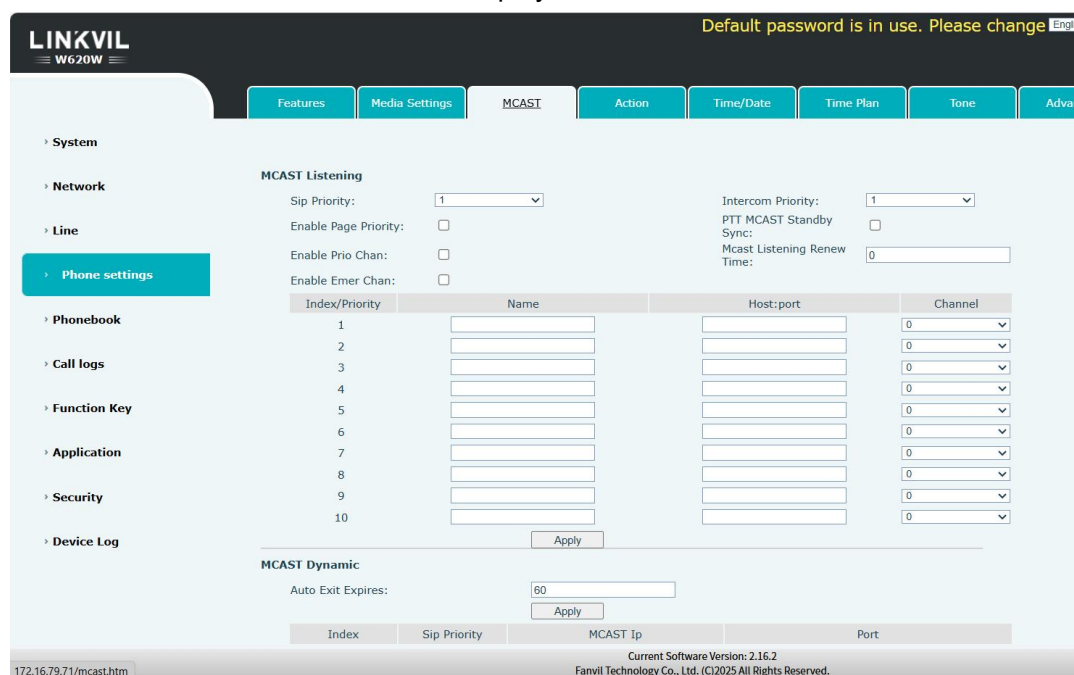

Picture 82 - Multicast Settings Page

Table 9 - MCAST Parameters on Web

Parameters	Description
Normal Call Priority	Define the priority of the active call. 1-10: Define the priority of normal calls, 1 is the highest priority, 10 is the lowest.
Enable Page Priority	The voice call in progress shall take precedence over all incoming paging calls.
Name	Listened multicast server name.
Host:port	Listened multicast server's multicast IP address and port.

Multicast:

- Go to web page of [Function Key] >> [Function Key Settings] , select the type to multicast, set the multicast address, and select the code.
- Click Apply.
- Set up the name, host and port of the receiving multicast on the web page of [Phone Settings] >> [MCAST].
- Press the DSS Key of Multicast Key which you set.
- Receive end will receive multicast call and play multicast automatically.

9.8 Message

9.8.1 SMS

If the service of the line supports the function of the short message, when the other end sends a text message to the number, the user will receive the notification of the short message and display the icon of the new SMS on the standby screen interface.

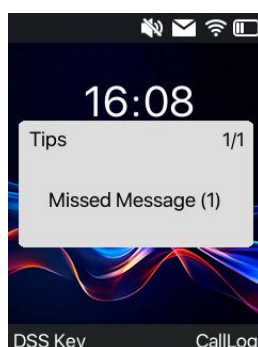

Picture 83 - SMS icon

Send messages:

- Press [OK] key in phone's standby mode to enter menu >> [Message] >> [SMS].
- Users can create new messages, select lines and send numbers.
- After editing is completed, click Send.

View SMS:

- Press [OK] key in phone's standby mode to enter menu >> [Message] >> [SMS].
- Select [Inbox] to enter the SMS inbox interface.
- Select the unread message and press [OK] to read the unread message.

Reply to SMS:

- Press [OK] key in phone's standby mode to enter menu >> [Message] >> [SMS].
- Select [Inbox] to enter the SMS inbox interface.
- Select the message you want to reply to, select [Option] >> [Reply], edit it, and click [Send].

9.8.2 MWI (Message Waiting Indicator)

If the service of the lines supports voice message feature, when the user is not available to answer the call, the caller can leave a voice message on the server to the user. User will receive voice message

notification from the server and device will prompt a voice message waiting icon on the standby screen.

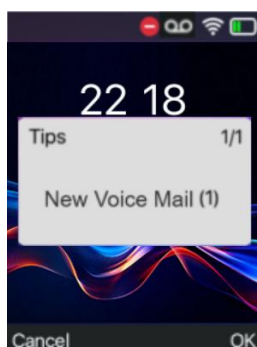

Picture 84 - New Voice Message Notification

Voice message icon

To listen to a voice message, the user must first configure the voicemail number. After the voicemail number is configured, the user can retrieve the voicemail of the default line.

When the phone is in the default standby state,

- Press [OK] key to enter menu >> [Message] >> [Voice Message]
- Open the voice message configuration interface, and select the line to be configured by pressing the up/down navigation keys.
- Press the [Edit] key to edit the voice message number. When finished, press the [OK] key to save the configuration.
- SIP1(m/n), “m” in front of Fanvil line brackets represents unread voice messages, and “n” represents the total number of voice messages.

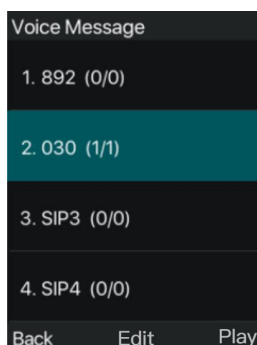

Picture 85 - Voice message interface

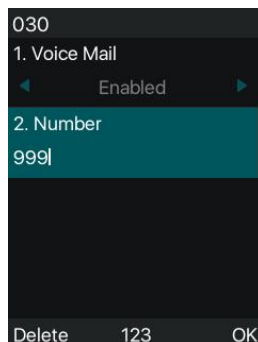

Picture 86 - Configure voicemail number

9.9 SIP Hotspot

SIP Hotspot is a simple and practical function. With simple configurations, the SIP Hotspot function can implement group ringing. SIP accounts can be expanded.

The users can set functions as a SIP Hotspot and other phones set (B and C) function as SIP Hotspot clients. When somebody calls phone set A, phone sets A, B, and C all ring at the same time. When any phone set answers the call, other phone sets stop ringing. The call can be answered by only one phone set. When B or C initiates a call, the SIP number registered by phone set A is the calling number.

To set a SIP Hotspot, register at least one SIP account.

Picture 87 - Register SIP account

Table 10 - SIP Hotspot Parameters

Parameters	Description
Enable Hotspot	Set it to be Enable to enable the feature.
Mode	Choose Hotspot, phone will be a “SIP Hotspot server”; Choose Client, phone will be a “SIP Hotspot Client”
Monitor Type	Either the Multicast or Broadcast is ok. If you want to limit the broadcast packets, you’d better use broadcast. But, if client choose broadcast, the SIP Hotspot phone

	must be broadcast.
Monitor Address	The address of broadcast, hotspot server and Hotspot client must be same.
Remote Port	Type the Remote port number.
Name	Fill in the name of the SIP Hotspot. This configuration is used to distinguish different hotspots in the network and avoid connection conflicts.
Line Settings	Set whether to associate and enable the SIP Hotspot function on the corresponding SIP line.

Configure SIP Hotspot server:

The screenshot shows the configuration page for a SIP Hotspot server. It includes a 'Client Table' with one entry (IP: 172.16.7.150, MAC: 0c:38:3e:36:d0:6f, Alias: 1, Line: 2,1). Below is the 'SIP Hotspot Settings' section with fields for: Enable Hotspot (Enabled), Mode (Hotspot), Monitor Type (Broadcast), Monitor Address (224.0.2.0), Local Port (16360), Name (SIP Hotspot), and Ring Mode (All). At the bottom is the 'Line Settings' section with Line 1 set to Enabled and an empty Ext Prefix 1 field.

Picture 88 - SIP Hotspot server configuration

Configure SIP Hotspot client:

To set as a SIP hotspot client, no SIP account needs to be set. The Phone set will automatically obtain and configure a SIP account. On the SIP Hotspot tab page, set Mode to Client. The values of other options are the same as those of the Hotspot.

The screenshot shows the configuration page for a SIP Hotspot client. It includes a 'Hotspot Table' with two entries: one at IP 172.16.7.160 (SIP Hotspot, OnLine, Disconnected) with a 'Connect' button, and one at IP 172.16.7.150 (SIP Hotspot, OnLine, Connected) with a 'Disconnect' button. Below is the 'SIP Hotspot Settings' section with fields for: Enable Hotspot (Enabled), Mode (Client), Monitor Type (Broadcast), Monitor Address (224.0.2.0), Local Port (16360), and Name (SIP Hotspot). At the bottom is the 'Line Settings' section with Line 1 and Line 2 both set to Enabled.

Picture 89 - SIP Hotspot client configuration

As the Hotspot server, the default extension number is 0. When the phone is used as the client, the extension number is increased from 1, you can view the extension number through the [SIP Hotspot] page.

Call extension number:

- The Hotspot server and the client can dial each other through the extension number.
- For example, extension 1 dials extension 0.

10 Phone Settings

10.1 Basic Settings

10.1.1 Language

The user can set the phone language through the phone interface and web interface.

- Phone interface: After resetting the factory settings, the user needs to set the language; when setting the language during standby, press [OK] key to enter menu >> [Basic] >> [Language] Settings, as shown in the figure.

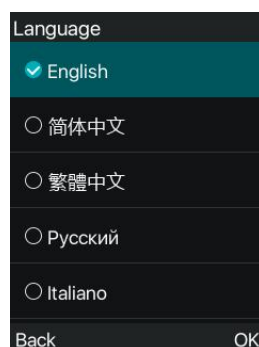

Picture 90 - Phone language setting

- Web interface: Log in to the phone web page and set the language in the drop-down box at the top right corner of the page, as shown in the figure:

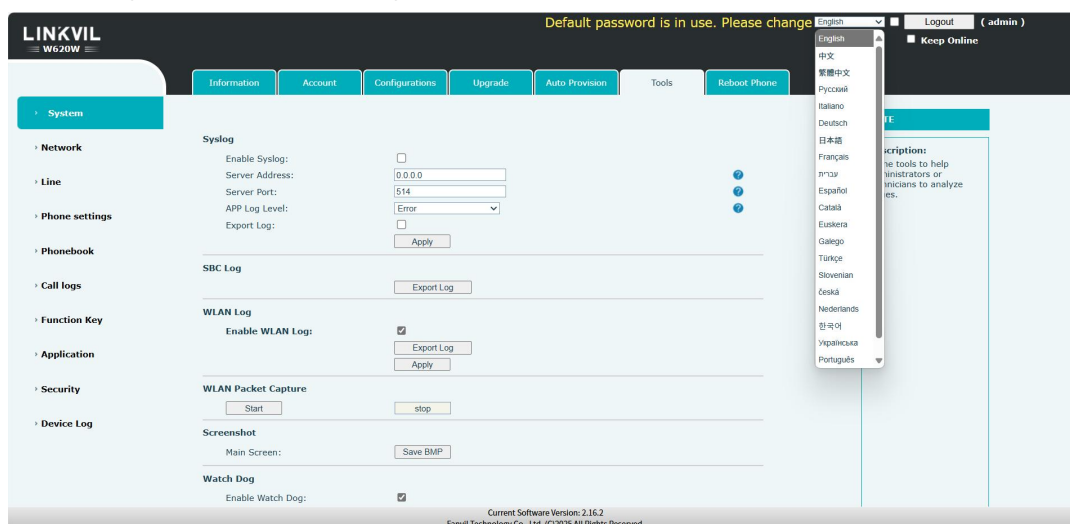

Picture 91 - Language setting on Web page

- The function box on the right side of the web interface language setting box is [Synchronize language to phone]; if selected, the phone language will be synchronized with the web page language. If it is not selected, it will not be synchronized.

10.1.2 Time & Date

Users can set the phone time through the phone interface and web interface.

- Phone interface: When the phone is in the default standby state, press [OK] key to enter menu >> [Basic] >> [Time & Date] , use the up/down navigation key to edit parameters, press the [OK] to save after completion, as shown in the figure:

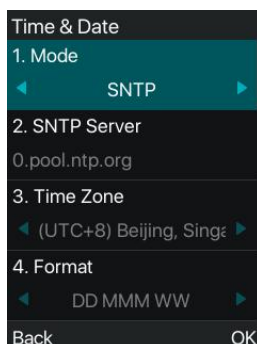

Picture 92 - Set time & date on phone

- Web end: Log in to the phone web page and enter [Phone Settings] >> [Time/Date] , as shown in the figure:

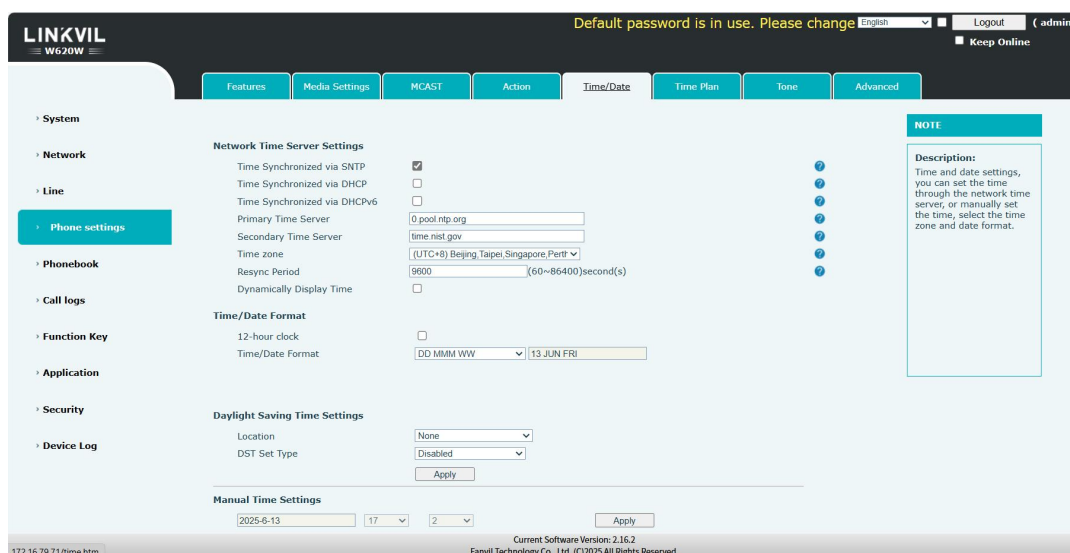

Picture 93 - Set time & date on web page

Table 11 - Time Settings Parameters

Parameters	Description
Mode	Auto/Manual Auto: Enable network time synchronization via SNTP protocol, default enabled. Manual: User can modify data manually.
SNTP Server	SNTP server address
Time zone	Select the time zone
Time format	Select time format from one of the followings: ■ DD MMM WW

	<ul style="list-style-type: none"> ■ WW DD MMM ■ WW MMM DD ■ DD MM YY ■ DD MM YYYY ■ MM DD YY ■ MM DD YYYY
Separator	Choose the separator between year and moth and day
12-Hour Clock	Display the clock in 12-hour format
Daylight Saving Time	Enable or Disable the Daylight Saving Time

10.1.3 Screen

The user can set the phone screen parameters through both of the phone interface and web interface.

- Phone: When the phone is in the default standby state, press [OK] key to enter menu >> [Basic] >> [Screen] to edit the screen parameters. After editing, click [OK] to save, as shown in the figure:

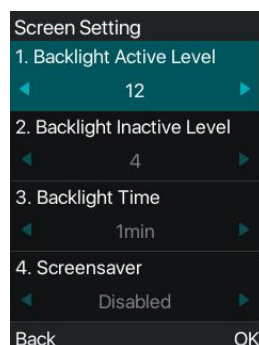

Picture 94 - Set screen parameters on phone

- Web : Go to [Phone Settings] >> [Advanced], edit the screen parameters, and click [Apply] to save.

10.1.3.1 Brightness and backlight

- Set the brightness level in use from 1 to 16, [<] or [>] switch brightness level.
- Set the brightness level in the energy-saving mode from 0 to 16, [<] or [>] switch the brightness level.
- Set the backlight time to 1 minute by default. You can turn it off or select 15 seconds / 30 seconds / 1 minute / 2 minutes / 5 minutes / 10 minutes / 30 minutes / 1 hour / 2 hours / 3 hours / 6 hours / 15 hours / Customer Value.
- Web interface: enter [Phone Settings] >> [Advanced], edit screen parameters, and click submit to save.

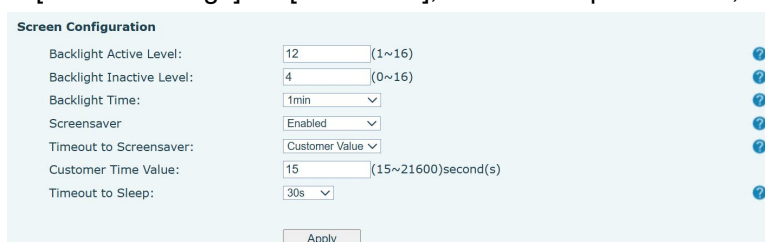

Picture 95 - Page screen Settings

10.1.3.2 Screen Saver

- Press [Screen Settings] to find the [Screensaver] key, press [left] / [right] key to open/close the screen protection, set the timeout time, the default is 15 s, after completion, press [OK] key to save.
- After saving, return to standby mode and enter the screen saver after 15 s, as follows:

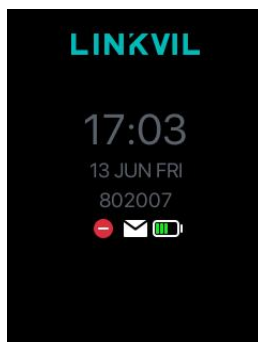

Picture 96 - Phone screen saver

10.1.4 Ring

- When the device is in the default standby mode, press [OK] key to enter menu >> [Basic].
- Enter [Basic] item till you find [Ring] item.
- Enter [Ring] item and you will find [Headset] or [Hands-free] item, press left/right navigator keys to adjust the ring volume, save the adjustment by pressing [OK] when done.
- Enter [Ring type] item, press left/right navigator keys to change the ring type, save the adjustment by pressing [OK] when done.

10.1.5 Voice Volume

- When the device is in the default standby mode, press OK key to enter menu >> [Basic].
- Enter [Basic] item till you find [Voice Volume] item.
- Enter [Voice Volume] item and you will find [Headset], [Hands-free] and [Headset] item.
- Enter [Headset] or [Hands-free] or [Headset] item, press Left/Right navigator keys to adjust the audio volume for different mode.
- Save the adjustment by pressing [OK] when done.

10.1.6 Greeting Words

- When the device is in the default standby mode, press [OK] key to enter menu >> [Basic].
- Enter [Basic] item till you find [Greeting Words] item.
- Press [OK] to enter the setting interface to edit the Greetings Words.
- Save the adjustment by pressing [OK] when done.

NOTICE! *The welcome message can only be displayed in the upper left corner of standby mode when the default option is disabled.*

10.1.7 Reboot

- When the device is in the default standby mode, press OK key to enter menu >> [Basic].
- Enter [Basic] item till you find [Reboot System] item.
- Press [OK] a prompt message, "restart now," prompts the user.

- Press [OK] to restart the phone or [Cancel].
The phone is in standby mode,
- The configurable [OK] key is the restart key. Press [OK], a prompt message, "restart now" prompts the user.
- Press [OK] to restart the phone or [Cancel] to exit.

10.2 Phone Book

10.2.1 Local Contact

User can save contacts' information in the phone book and dial the contact's phone number(s) from the phone book. To open the phone book, user should press [Menu] >> [Contact] in the default standby screen or keypad. By default the phone book is empty, user may add contact(s) into the phone book manually or from call logs.

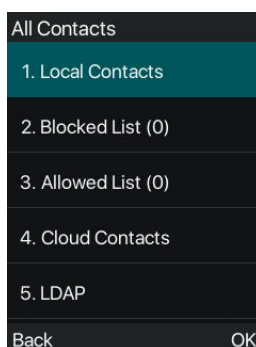

Picture 97 - Phone book screen

Note!Phone user account can store contact information, different models and specifications.

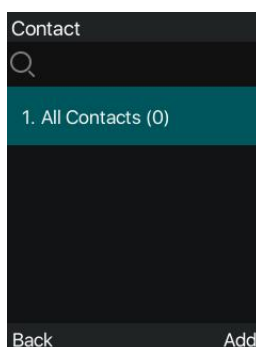

Picture 98 - Local Phone book

When there are contact records in the phone book, the contact records will be arranged in the alphabet order. User may browse the contacts with up/down navigator keys. The record indicator tells user which contact is currently focused. User may check the contact's information by pressing [OK] key.

10.2.1.1 Add / Edit / Delete Contact

To add a new contact, user should press [Add] key to open Add Contacts screen and enter the contact

information of the followings,

- Contact Name
- Tel. Number
- Mobile Number
- Other Number
- Line
- Ring Tone
- Contact Group

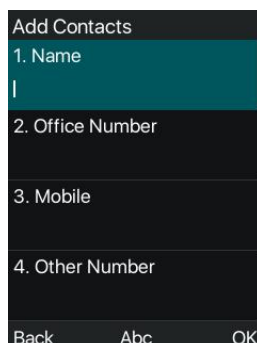

Picture 99 - Add New Contact

User can edit a contact by pressing [Option] >> [Edit] key.

To delete a contact, user should move the record indicator to the position of the contact to be deleted, press [Option] >> [Delete] key and confirm with [OK].

10.2.1.2 Add / Edit / Delete Group

By default, the group list is blank. User can create his/her own groups, edit the group name, add or remove contacts in the group, and delete a group.

- To add a group, press [Add Group] key.
- To delete a group, press [Option] >> [Delete] key.
- To edit a group, press [Edit] key.

The Number behind the group name means the total contacts number of selected groups.

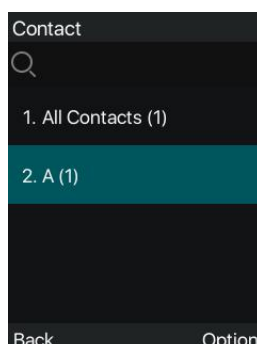

Picture 100 - Group List

10.2.1.3 Browse and Add / Remove Contacts in Group

User can browse contacts in a group by opening the group in group list with [OK] key.

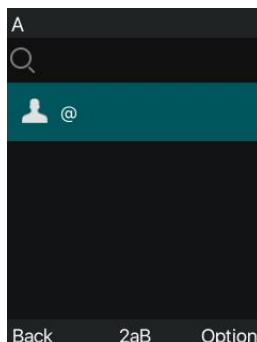

Picture 101 - Browsing Contacts in a Group

When user is browsing contacts of a group, user can also add contacts in that group by pressing [Add] key to enter the group contacts management interface, then press [OK] key to save the contact. The contact will also be added in local contacts. User can delete contact from group by [Option] >> [Delete].



Picture 102 - Add Contacts in a Group

10.2.2 Blocked List

The device Support Blocked List, such as the number added to the Blocked List, the number of calls directly refused to the end, the end of the phone shows no incoming calls. (Blocked Listed Numbers can be called out normally)

- There are multiple ways to add a phone number to the Call Block List on the phone. You can press [OK] key in standby mode to access menu, then navigate to [Contact] >> [Blocked List] to add it.
- Select any number in the phone book (both local and network) for configuration addition.
- Select any number in the call log for configuration addition.

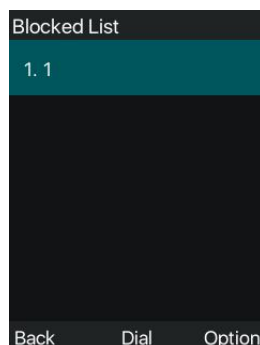

Picture 103 - Add Blocked List

- There are various ways to add number to the Blocked List on web page, which can be added in the [Contact] >> [Call list] >> [Restricted Incoming Calls].
- Select any number in the phone book (both local and network) for configuration addition.
- Select any number in the call log for configuration addition.

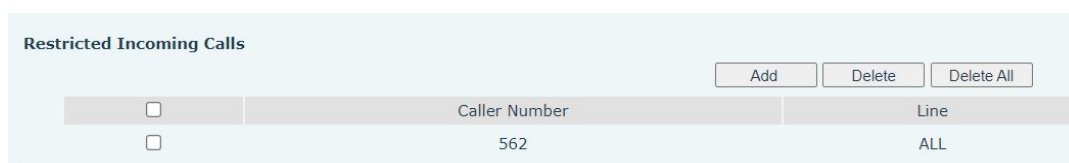

Picture 104 - Web Blocked List

10.2.3 Cloud Contacts

10.2.3.1 Configure Cloud Contacts

Cloud contacts allows user to configure the device by downloading a contacts from a cloud server. This is convenient for office users to use the contacts from a single source and save the effort to create and maintain the contact list individually. It is also a useful tool to synchronize his/her contacts from a personal mobile phone to the device with Fanvil Cloud contacts Service and App which is to be provided publicly soon.

NOTICE! The cloud contacts is ONLY temporarily downloaded to the device each time when it is opened on the device to ensure the user get the latest phonebook. However, the downloading may take a couple seconds depending on the network condition. Therefore, it is highly recommended for the users to save important contacts from cloud to local phonebook for saving download time.

Open cloud contacts list, press [OK] key in standby mode to enter menu >> [Contact] >> [Cloud Contacts].

TIPS! The first configuration on cloud phone should be completed on Web page by selecting [Contact] >> [Cloud Contacts]. The setting of addition/deletion on device could be done after the first setting on Web page.

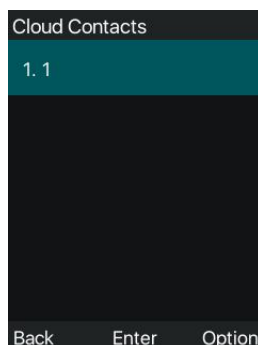

Picture 105 - Cloud phone book list

10.2.3.2 Downloading Cloud Contacts

In cloud contacts screen, user can open a cloud contact by pressing [OK] / [Enter] key. The device will start downloading the phone book. The user will be prompted with a warning message if the download fails. Once the cloud phone book is downloaded completely, the user can browse the contact list and dial the contact number same as in local contacts.

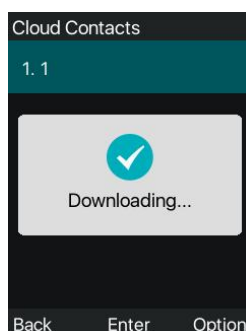

Picture 106 - Downloading Cloud Phone book

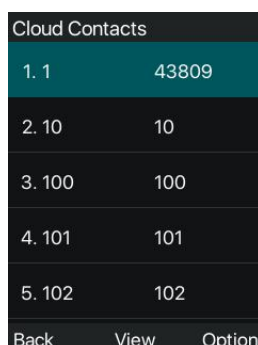

Picture 107 - Browse contacts in cloud phone book

10.3 Call Log

The phone can store the call record (the quantity of storage varies according to different specifications). The user can press [soft key-CallLog] in standby mode >> [Local Call Logs] to open the call record and check

the records of all incoming calls, outgoing calls and missed calls.

In the call logs interface, user may browse the call logs with up/down navigator keys.

Each call log record is presented with 'call type' and 'call party number / name'. User can check further call log detail by pressing [OK] key and dial the number with [Dial] key, or add the call log number to phonebook with pressing [Option] >> [Add to Contact] .

User can delete a call log by pressing [Delete] key and clear all call logs by pressing [Delete All] key.

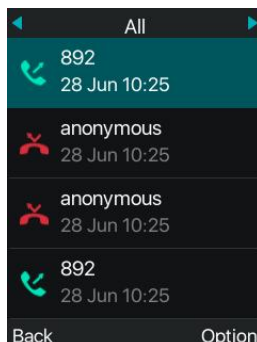

Picture 108 - Call Log

Users can also filter the call records of specific call types to narrow down the scope of search records, and select a call record type by left and right navigation keys.



- Missed Call Log



- Incoming Call Log



- Outgoing Call Log



- Forward Call Log

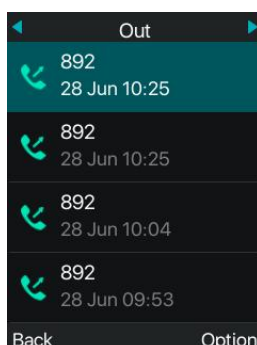

Picture 109 - Filter call record types

10.4 Function Key

Users can customize and configure the function keys on the side of the phone, and users can modify the settings of the corresponding keys by short/long press on the unconfigured shortcut keys.

Note: When the configuration key is configured as a function key type (such as PTT) triggered by a long press, and the health value is configured, users can press [OK] key in phone's standby mode to enter menu >> [Basic] >> [Keyboard] >> [DSS Key Settings] or push the physical key [DSS Key] or configure and change the value of the function key on the web page.

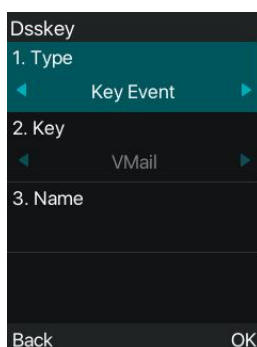

Picture 110 - DSS LCD key Page Configuration Screen

The DSS Key could be configured as followings,

- Memory Key
 - Speed Dial / Intercom / MWI / Call Forward (to someone)
- Line
- Key Event
 - MWI / DND / Hold / Transfer / Phonebook / Redial / Pickup / Call Forward (to specified line) / Headset / SMS / Release
- DTMF
- Action URL
- Multicast
- XML Browser
- PTT

web page interface: **[Function key]** >> **[Side key]**.

Function Key Settings

Dsskey Transfer Mode: ▾

Dsskey Edit: ▾

Key	Type	Name	Value	Subtype	Line	PickUp Number
DSS Key 1	Key Event ▾	<input type="text"/>	<input type="text"/>	Redial ▾	AUTO ▾	<input type="text"/>

Picture 111 - DSS settings

Moreover, user also can add the user-defined title for the DSS Keys, which is configured as Memory Key / Line / URL / Multicast / Prefix.

More detailed information *refers to* [12.25 Function Key](#) and [6.3 Appendix III –LED](#) .

10.5 Wi-Fi

The device has built-in Wi-Fi and supports wireless Internet access. For more details, please refer to [7.4 Connection Wi-Fi](#).

10.6 Headset

10.6.1 Wired Headset

The device supports wired headset with a Type-C headset jack, enabling functions such as playing incoming call alert tones through the headset and making calls via the headset.

After the phone is connected to the headset, the status bar displays the headset icon, indicating that the headset channel is available.

On the web page [Phone settings] >> [Features], you can set the headset answering function, and the ring tone for headset.

Note: W620W enables these two configurations by default.

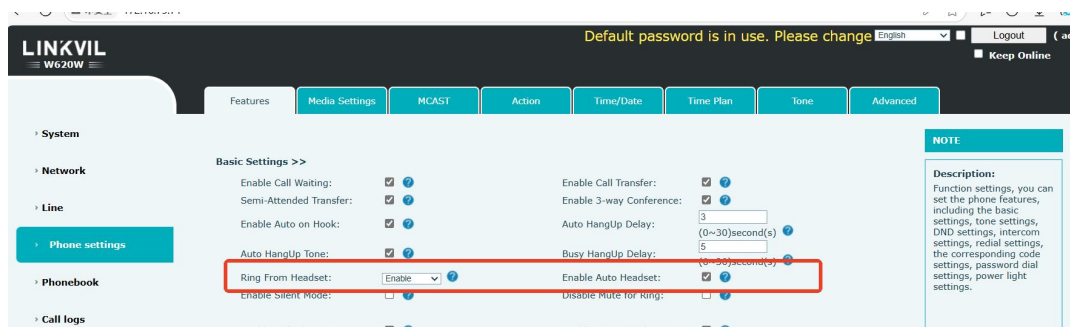

Picture 112 - Headset function settings

10.6.2 Bluetooth Headset

The device has a built-in Bluetooth 5.0 module

- Press [OK] key to enter Menu till you find the [Basic] item.
- Press [Bluetooth] to enter the setup interface.
- Select Bluetooth, and use the left and right keys to enable Bluetooth. Select Paired Device. If no paired is displayed, press [OK] key to search and select the scanned device to connect.

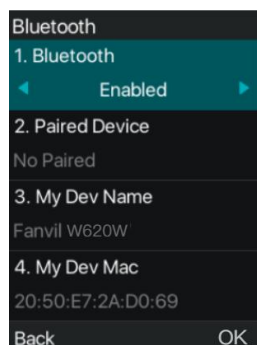

Picture 113 - Bluetooth Settings Screen

The use of Bluetooth headset can be divided into three types: call answering; Hang up; Bluetooth redial.

- call answering

When the Bluetooth headset is connected to the phone, the incoming call can be answered by pressing the Bluetooth answer key.

- Hang up

1) When talking with Bluetooth headset, you can hang up the phone by pressing the key on Bluetooth headset.

2) When there is an incoming call, double-click the answer key to reject the call.

3) When the caller is in the ringing state, press the answer key of the headset to cancel the call.

- Bluetooth redial

When the Bluetooth headset is connected, double-click the answer key to redial the number dialed last time.

NOTICE! Some models do not support double - click redial function. Whether this function is supported or not, you can check the instruction of the headset, or connect the Bluetooth headset to the phone, and double-click the answer key to see whether it will redial.

10.7 Advanced

10.7.1 Line Configurations

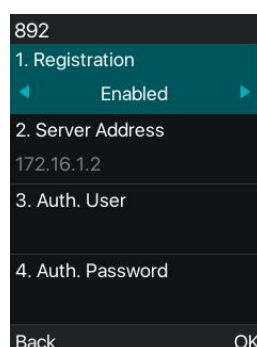

Picture 114 - SIP address and account information

Save the adjustment by pressing [OK] when done.

Users who want to configure more options should use web management portal to modify or system in accounts on the individual line to configure those options.

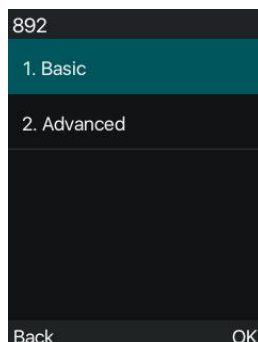

Picture 115 - Configure Advanced Line Options

10.7.2 Network Settings

10.7.2.1 Network Settings

■ IP Mode

There are 3 network protocol mode options, IPv4, IPv6 and IPv4 & IPv6.

Users can set it on the web page [Network] >> [Basic]. Select Wi-Fi for the net type, and you can set the network mode.

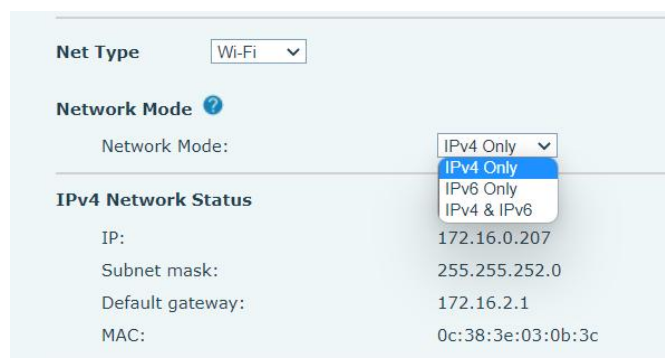

Picture 116 - Network mode Settings

■ IPv4

In IPv4 mode, there are 3 connection mode options: DHCP, PPPoE and Static IP.

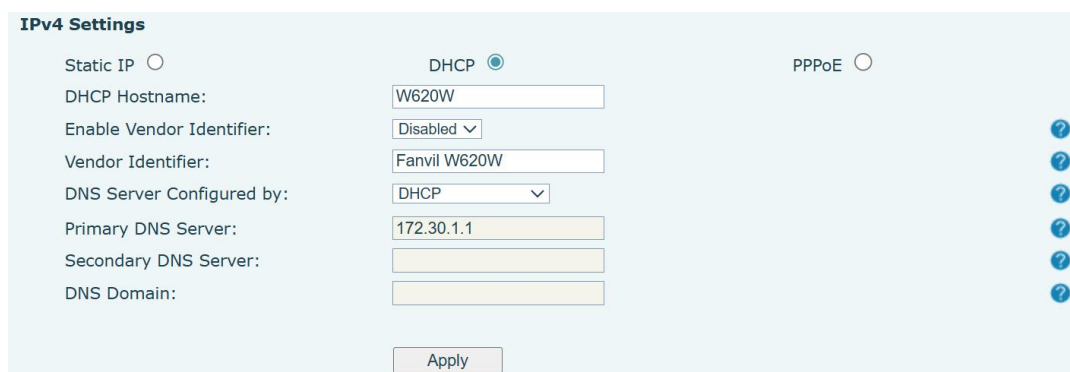

Picture 117 - DHCP network mode

When using DHCP mode, phone will get the IP address from DHCP server (router).

- Use DHCP DNS: It is enabled as default. “Enable” means phone will get DNS address from DHCP server and “disable” means not.
- Use DHCP time: It is disabled as default. “Enable” to manage the time of get DNS address from DHCP server and “disable” means not.

Picture 118 - PPPoE network mode

When using PPPoE, phone will get the IP address from PPPoE server.

- Username: PPPoE user name.
- Password: PPPoE password.

Picture 119 - Static IP network mode

When using Static IP mode, user must configure the IP address manually.

- IP Address: Phone IP address.
- Mask: sub mask of your LAN.
- Gateway: The gateway IP address. Phone could access the other network via it.
- Primary DNS: Primary DNS address. The default is 8.8.8.8, Google DNS server address.
- Secondary DNS: When primary DNS is not available, Secondary DNS will work.

■ **IPv6**

In IPv6, there are 2 connection mode options, DHCP and Static IP.

- DHCP configuration refers to IPv4 introduction in last page.
- Static IP configuration is almost same as IPv4's, except the IPv6 Prefix.
- IPv6 Prefix: IPv6 prefix, it is similar with mask of IPv4.

Picture 120 - IPv6 Static IP network mode

10.7.2.2 VPN

Virtual Private Network (VPN) is a technology to allow device to create a tunneling connection to a server and becomes part of the server’s network. The network transmission of the device may be routed through the VPN server.

For some users, especially enterprise users, a VPN connection might be required to be established before activate a line registration. The device supports two VPN modes, Layer 2 Transportation Protocol (L2TP) and OpenVPN.

The VPN connection must be configured and started (or stopped) from the device web portal.

■ L2TP

NOTICE! The device only supports non-encrypted basic authentication and non-encrypted data tunneling. For users who need data encryption, please use OpenVPN instead.

To establish a L2TP connection, users should log in to the device web portal, open web page [Network] >> [VPN]. In VPN Mode, check the [Enable VPN] option and select [L2TP], then fill in the L2TP server address, Authentication Username, and Authentication Password in the L2TP section. Press [Apply] and the device will try to connect to the L2TP server.

When the VPN connection established, the VPN IP Address should be displayed in the VPN status. There may be the delay of the connection establishment. User may need to refresh the page to update the status.

Once the VPN is configured, the device will try to connect with the VPN automatically when the device boots up every time until user disable it. Sometimes, if the VPN connection does not establish immediately, user may try to reboot the device and check if VPN connection established after reboot.

■ OpenVPN

To establish an OpenVPN connection, user should get the following authentication and configuration files from the OpenVPN hosting provider and name them as the following,

- OpenVPN Configuration file: // client.ovpn
- CA Root Certification: // ca.crt
- Client Certification: // client.crt
- Client Key: // client.key

User then upload these files to the device in the web page [Network] >> [VPN], select OpenVPN Files.

Then user should check “Enable VPN” and select [OpenVPN] in VPN Mode and click [Apply] to enable OpenVPN connection. Same as L2TP connection, the connection will be established every time when system rebooted until user disable it manually.

10.7.2.3 Web Server Type

Configure the Web Server mode to be HTTP or HTTPS and will be activated after the reboot. Then user could use HTTP / HTTPS protocol to access phone web page. Press [OK] key in phone’s standby mode to enter menu >> [Advanced] >> [Network] >> [Web Server Type]

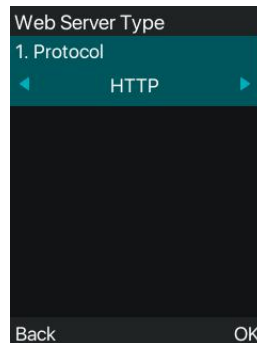

Picture 121 - The phone configures the web server type

10.7.3 Set The Secret Key

When the device is in the default standby mode,

- Press [OK] key to enter menu >> [Advanced].
- As default, the Advance setting password is 123. Select [Security] ,then user will see the follow page Security.

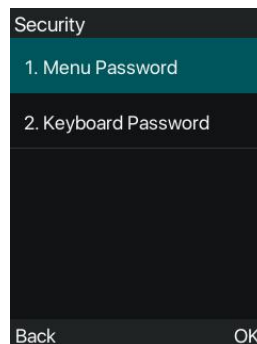

Picture 122 - Menu password

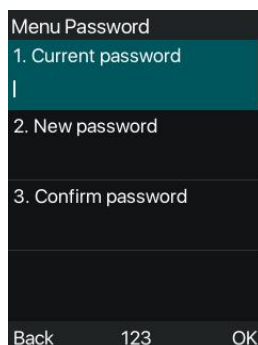

Picture 123 - Set menu password

Menu password is the permission for accessing the advanced setting.

- [Current password] is the password user configured before. If no configuration before, the default password is 123.
- [New password] is the new password user to use.
- After configuring the menu password, it will work immediately.

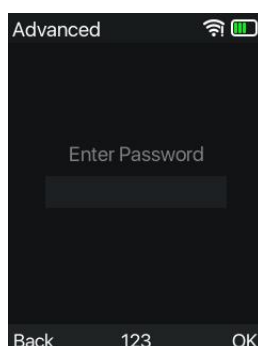

Picture 124 - Keyboard lock password

Keyboard password is used to unlock the phone once it's locked.

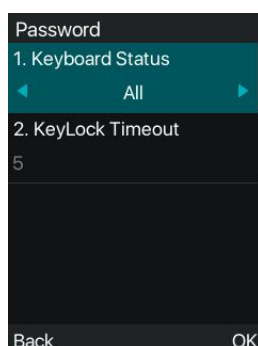

Picture 125 - Set keyboard lock password

User could only set to enable or disable the keyboard password in LCD screen.

- Enter [Keyboard password] setting by pressing [soft key-OK] or [OK] key after password entered. If no menu password configuration before, it is 123 as default.

- If the menu password is correct, phone will go to keyboard password interface. As default, the keyboard password is disabled. When it is enabled, the keyboard will be locked after timeout.
- If user does not configure the keyboard lock time, (it is 0 as default). Long pressing [#] will lock the phone. There will be a lock icon in the top of LCD. Phone will reminder “Enter Password” after pressing any keys.

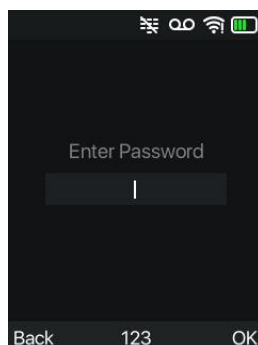

Picture 126 - Phone keypad lock password input interface

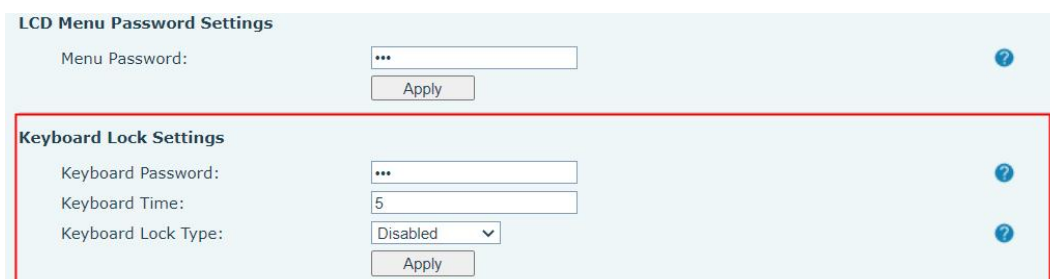

Picture 127 - Web keyboard lock password settings

10.7.4 Auto provision

Phone Web page: Login and go to [System] >> [Auto provision].

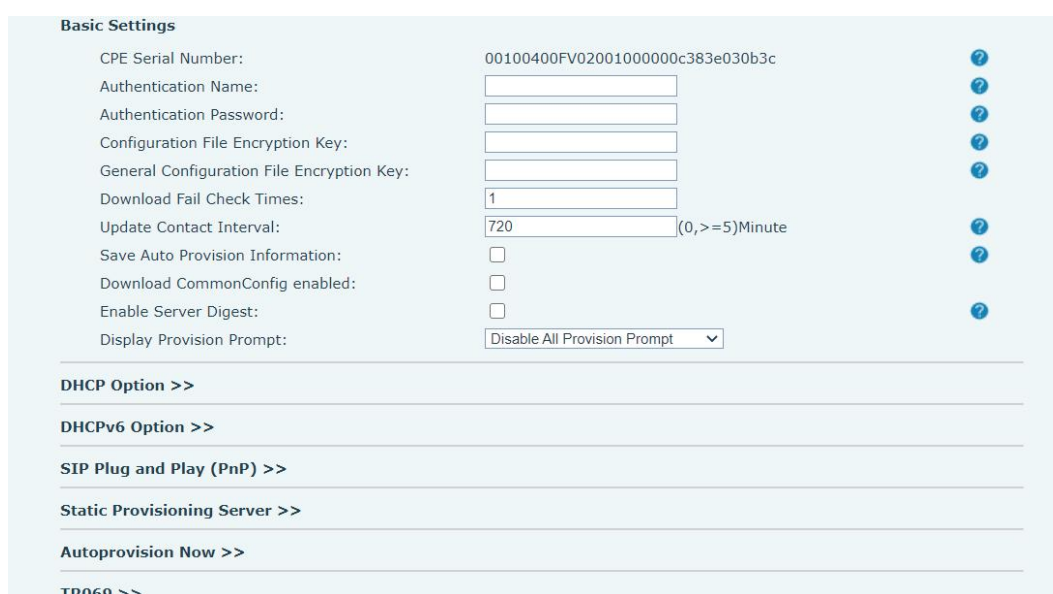

Picture 128 - Page auto provision Settings

LCD: Press [OK] key in standby mode to enter menu >> [Advanced] >> [Maintenance] >> [Auto Provision].

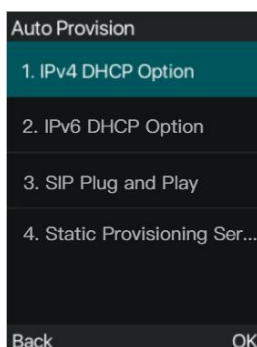

Picture 129 - Phone auto provision settings

Fanvil devices support SIP Plug and Play, DHCP options, Static provision, TR069. If all of the 4 methods are enabled, the device will be upgraded according to the method obtained first.

Transferring protocol: FTP, TFTP, HTTP, HTTPS

This article only briefly introduces automatic deployment. For details, please refer to the document **Fanvil Auto Provision**.

Table 12 - Auto Provision

Parameters	Description
Basic settings	
CPE Serial Number	Display the device SN
Authentication Name	The user name of provision server
Authentication Password	The password of provision server
Configuration File Encryption Key	If the device configuration file is encrypted , user should add the encryption key here.
General Configuration File Encryption Key	If the common configuration file is encrypted, user should add the encryption key here.
Download Fail Check Times	If there download is failed, phone will retry with the configured times.
Update Contact Interval	Phone will update the phonebook with the configured interval time. If it is 0, the feature is disabled.
Save Auto Provision Information	Save the HTTP/HTTPS/FTP user name and password. If the provision URL is kept, the information will be kept.
Download Common Config enabled	Whether phone will download the common configuration file.
Enable Server Digest	When the feature is enable, if the configuration of server is changed, phone will download and update.
DHCP Option	
Option Value	Configure DHCP option, DHCP option supports DHCP custom option

	DHCP option 66 DHCP option 43, 3 methods to get the provision URL. The default is Option 66.
Custom Option Value	Custom Option value is allowed from 128 to 254. The option value must be same as server define.
Enable DHCP Option 120	Use Option120 to get the SIP server address from DHCP server.
SIP Plug and Play (PnP)	
Enable SIP PnP	Whether enable PnP or not. If PnP is enable, phone will send a SIP SUBSCRIBE message with broadcast method. Any server can support the feature will respond and send a SIP Notify with URL to phone. Phone could get the configuration file with the URL.
Server Address	Broadcast address. As default, it is 224.0.0.0.
Server Port	PnP port
Transport Protocol	PnP protocol, TCP or UDP.
Update Interval	PnP message interval
Static Provisioning Server	
Server Address	Provisioning server address. Support both IP address and domain address.
Configuration File Name	The configuration file name. If it is empty, phone will request the common file and device file which is named as its MAC address. The file name could be a common name, \$mac, \$input. The file format supports CFG/TXT/XML.
Protocol Type	Transferring protocol type , supports FTP、TFTP、HTTP and HTTPS
Update Interval	Configuration file update interval time. As default it is 1, means phone will check the update every 1 hour.
Update Mode	Provision Mode. 1. Disabled. 2. Update after reboot. 3. Update after interval.
TR069	
Enable TR069	Enable TR069 after selection
ACS Server Type	There are 2 options Serve type, Common and CTC.
ACS Server URL	ACS server address
ACS User	ACS server username (up to is 59 characters)
ACS Password	ACS server password (up to is 59 characters)
Enable TR069 Warning Tone	If TR069 is enabled, there will be a prompt tone when connecting.
TLS Version	TLS version (TLS 1.2, TLS 1.3)
INFORM Sending Period	INFORM signal interval time. It ranges from 1s to 999999s
STUN Server Address	Configure STUN server address

STUN Enable	To enable STUN server for TR069
-------------	---------------------------------

10.7.5 Firmware Upgrade

- Web page: Login phone web page, go to [System] >> [Upgrade]

Picture 130 - Web page firmware upgrade

- LCD interface: press [OK] in phone's standby mode to enter menu>> [Advanced setting] >> [Firmware Upgrade] .

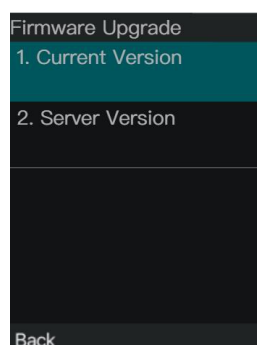

Picture 131 - Firmware upgrade information display

Table 13 - Firmware upgrade

Parameter	Description
Upgrade server	
Enable Auto Upgrade	Enable automatic upgrade, If there is a new version TXT and new software firmware on the server, phone will show a prompt upgrade message after Update Interval.
Upgrade Server Address1	Set available upgrade server address.
Upgrade Server Address2	Set back up available upgrade server address.

Update Interval	Set Update Interval. Enable Auto Upgrade and configure the Update Interval. If the server has a new firmware, the phone will prompt for upgrade at the interval.
Firmware Information	
Current Software Version	It will show Current Software Version.
Server Firmware Version	It will show Server Firmware Version.
[Upgrade] key	If there is a new version TXT and new software firmware on the server, the page will display version information and upgrade key will become available; Click [Upgrade] key to upgrade the new firmware.
New version description information	When there is a corresponding TXT file and version on the server side, the TXT and version information will be displayed under the new version description information.

- The file requested from the server is a TXT file called vendor_model_hwv1_0.txt. hwv followed by the hardware version number, it will be written as hw1_0 if no difference on hardware. All Spaces in the filename are replaced by underline.
For example, the TXT file name requested by W620W phone is fanvil_w620w_hwv1_0.txt.
- The URL requested by the phone is HTTP:// server address/, the new version and the requested file should be placed in the download directory of the HTTP server, as shown in the figure:

名称	修改日期	类型	大小
fanvil_w620w_hwv1_0.txt	2024/2/19 11:26	文本文档	1 KB
w620w-Linkvil-release-9011-a00e-2.16.10-Ukrvt2025-07-22-09.43.48.z	2025/7/29 18:51	360压缩	39,580 KB

Picture 132 - HTTP server download directory

- TXT file format must be UTF-8
- The format of the file “ vendor_model_hwv1_0.txt ” is as follows:
Version=2.16.10 #Firmware version
Firmware=xxx/xxx.z #URL, Relative paths are supported and absolute paths are possible, distinguished by the presence of protocol headers.
BuildTime=2022.05.06 20:00
Info=TXT

Xxxxx
Xxxxx
Xxxxx
Xxxxx
- After the update cycle interval time arrives, if the server has available files and versions, the phone will prompt as shown below, click View to view the version information and upgrade.

10.7.6 Factory Reset

- 1) The phone is in default standby mode.
 - Press [OK] key to enter menu >> [Advanced], and press [OK].
 - Press [Advanced] to enter the password (default password is 123) to enter the interface.
 - Press the [Factory Reset] key to select the file to be cleared.
 - Press [OK] to clear after completion. When you select clear configuration file and clear all, the phone will restart automatically after clearing.

- 2) In standby, press and hold the [OK] key for 6 s to perform the reset operation.

11 Web Configurations

11.1 Web Page Authentication

The user can log into the web page of the phone to manage the user's phone information and operate the phone. Users must provide the correct user name and password to log in.

11.2 System >> Information

User can get the system information of the device in this page including,

- Model
- Hardware Version
- Software Version
- Uboot
- Uptime
- Memory information
- System time

And contains network status,

- Network Mode
- Ethernet MAC
- Wi-Fi MAC
- Bluetooth MAC
- Ethernet IP
- Wi-Fi IP
- Subnet Mask
- Default Gateway

Besides, contains SIP account status,

- SIP User
- SIP account status (Registered / Inactive / Trying / Timeout)

11.3 System >> Account

On this page the user can change the password for the login page.

Users with administrator rights can also add or delete users, manage users, and set permissions and passwords for new users.

11.4 System >> Configurations

On this page, users with administrator privileges can view, export, or import the phone configuration, or restore the phone to factory Settings.

■ Clear Configurations

Select the module in the configuration file to clear.

SIP: account configuration.

Basic Network: Basic network configuration.

AutoProvision: automatically upgrades the configuration

TR069:TR069 related configuration

MMI: MMI module, including authentication user information, web access protocol, etc.

Dsskey: DSS Key configuration

■ Clear Userdata

Select the local data table to be cleared, all selected by default.

■ Clear ETC

Select the ETC files to be cleared, including authentication cert, https, SIP Accounts, OpenVPN, mmiset, language, and wallpaper.

■ Reset Phone

The phone data will be cleared, including configuration and database tables.

11.5 System >> Upgrade

Upgrade the phone software version, customized ringtone, background, boot logo icon, etc, can also be upgraded to delete the file. Ring tone support “.wav” format.

11.6 System >> Auto Provision

The Auto Provision settings help IT manager or service provider to easily deploy and manage the devices in mass volume. For the detail of Auto Provision, please refer to [10.7.4 Auto provision](#).

11.7 System >> Tools

Tools provided in this page help users to identify issues at trouble shooting. Please refer to [13 Trouble Shooting](#) for more detail.

11.8 System >> Reboot Phone

This page can reboot the phone.

12 Network >> Basic

This page allows users to configure network connection types and parameters.

12.1 Network >> Wi-Fi Settings

The default network priority is Wi-Fi.

The current device supports coexistence of Wi-Fi and Ethernet, and users can log in to the web page with any network address for configuration.

For example, Wi-Fi access IP is 172.16.3.138 and Ethernet access IP is 172.16.7.116.

Page login 172.16.7.116, 172.16.3.138 Any network address login page for configuration.

The screenshot shows the 'Network Adapter' configuration page. At the top, there is a 'Network Adapter Priority' section with a list containing 'Wi-Fi' and 'Ethernet'. 'Wi-Fi' is selected and highlighted. To the right of the list are up and down arrow buttons. Below the list is an 'Apply' button. The 'Net Type' is set to 'Wi-Fi'. The 'Network Mode' is set to 'IPv4 Only'. Below this is the 'IPv4 Network Status' section with the following details:

IP:	172.16.3.138
Subnet mask:	255.255.252.0
Default gateway:	172.16.7.1
MAC:	08:e9:f6:11:0e:b8

Picture 133 - Network Priority

This page can turn on Wi-Fi, add Wi-Fi information, and view the wireless network list.

The screenshot shows the 'Wi-Fi Settings' configuration page. It includes the following sections:

- Wi-Fi Settings:**
 - Wi-Fi Enable:
 - Roaming Delta: (3~30)dB
 - Roaming Scan Period: (1~3600)s
 - Wi-Fi Country Code:
 - Band Mode:
 - Roaming Trigger: (-70~-50)dBm
 - Full Roam Scan Period: (1~3600)s
- Wi-Fi Info Add:**
 - Wi-Fi Name:
 - SSID:
 - Secure Mode:
- Wi-Fi Info List:**

<input type="checkbox"/>	SSID	Secure Mode	Encryption Type
<input type="checkbox"/>	WiFi-device-ssid	WPA/WPA2-PSK	None
<input type="checkbox"/>	Fanvil	WPA/WPA2-PSK	None

Picture 134 - Wi-Fi Settings

12.2 Network >> Service Port

This page provides settings for Web page login protocol, protocol port settings and RTP port.

Picture 135 - Service Port Settings

Table 14 - Service port

Parameter	Description
Web Server Type	Reboot to take effect after settings. Optionally, the web page login is HTTP/HTTPS.
Web Logon Timeout	Default as 15 minutes, the timeout will automatically exit the login page, need to login again.
Web auto login	After the timeout does not need to enter a user name password, will automatically login to the web page.
HTTP Port	The default is 80. If you want system security, you can set ports other than 80. Such as :8080, web page login: HTTP://ip:8080
HTTPS Port	The default is 443, the same as the HTTP port.
TLS Version	The version of TLS.
RTP Port Range Start	The value range is 1025 to 65535. The value of RTP port starts from the initial value set. For each call, the value of voice and video port is added 2.
RTP Port Quantity	Number of calls.

12.3 Network >> VPN

Users can configure a VPN connection on this page. See [10.7.2.2 VPN](#) for more details.

12.4 Network >> Advanced

Advanced network Settings are typically configured by the IT administrator to improve the quality of the phone service. For configuration, query the [10.7 Advanced](#) Settings.

12.5 Line >> SIP

Configure the Line service configuration on this page.

Table 15 - Line configuration on the web page

Parameters	Description
Register Settings	
Line Status	Display the current line status at page loading. To get the up to date line status, user has to refresh the page manually.
Activate	Whether the service of the line is activated.
Username	Enter the username of the service account.
Authentication User	Enter the authentication user of the service account.
Display Name	Enter the display name to be sent in a call request.
Authentication Password	Enter the authentication password of the service account.
Realm	Enter the SIP domain if requested by the service provider.
Server Name	Input server name.
SIP Server 1	
Server Address	Enter the IP or FQDN address of the SIP server
Server Port	Enter the SIP server port, default is 5060
Transport Protocol	Set up the SIP transport line using TCP or UDP or TLS.
Registration Expiration	Set SIP expiration date.
Proxy Server Address	Enter the IP or FQDN address of the SIP proxy server.
Proxy Server Port	Enter the SIP proxy server port, default is 5060.
Proxy User	Enter the SIP proxy user.
Proxy Password	Enter the SIP proxy password.
SIP Server 2	
Server Address	Enter the IP or FQDN address of the SIP server.
Server Port	Enter the SIP server port, default is 5060.
Transport Protocol	Set up the SIP transport line using TCP or UDP or TLS.
Registration Expiration	Set SIP expiration date.
Backup Proxy Server Address	Enter the IP or FQDN address of the backup proxy server.
Backup Proxy Server Port	Enter the backup proxy server port, default is 5060.
Basic Settings	
Enable Auto Answering	Enable auto-answering, the incoming calls will be answered automatically after the delay time.
Auto Answering Delay	Set the delay for incoming call before the system automatically answered it.
Call Forward	Enable unconditional call forward, all incoming calls will be forwarded to the

Unconditional	number specified in the next field.
Call Forward Number for Unconditional	Set the number of unconditional call forward.
Call Forward on Busy	Enable call forward on busy, when the phone is busy, any incoming call will be forwarded to the number specified in the next field.
Call Forward Number for Busy	Set the number of call forward on busy .
Call Forward on No Answer	Enable call forward on no answer, when an incoming call is not answered within the configured delay time, the call will be forwarded to the number specified in the next field.
Call Forward Number for No Answer	Set the number of call forward on no answer.
Call Forward Delay for No Answer	Set the delay time of not answered call before being forwarded.
Transfer Timeout	Set the timeout of call transfer process.
Conference Type	Set the type of call conference, Local=set up call conference by the device itself, maximum supports two remote parties, Server=set up call conference by dialing to a conference room on the server.
Server Conference Number	Set the conference room number when conference type is set to be Server.
Subscribe For Voice Message	Enable the device to subscribe a voice message waiting notification, if enabled, the device will receive notification from the server if there is voice message waiting on the server.
Voice Message Number	Set the number for retrieving voice message.
Voice Message Subscribe Period	Set the interval of voice message notification subscription.
Enable Hotline	Enabling hotline configuration, the device will dial to the specific number immediately at audio channel opened by off-hook handset or turn on hands-free speaker or headset.
Hotline Delay	Set the delay for hotline before the system automatically dialed it.
Hotline Number	Set the hotline dialing number.
Dial Without Registered	Set call out by proxy without registration.
Enable Missed Call Log	If enabled, the phone will save missed calls into the call history record.
DTMF Type	Set the DTMF type to be used for the line.
DTMF SIP INFO Mode	Set the SIP INFO mode to send '*' and '#' or '10' and '11'.
Request With Port	Whether the URI carries port number.
Enable DND	Enable Do-not-disturb, any incoming call to this line will be rejected automatically.

Use VPN	Set the line to use VPN restrict route.
Use STUN	Set the line to use STUN for NAT traversal.
Enable Failback	Whether to switch to the primary server when it is available.
Failback Interval	A Register message is used to periodically detect the time interval for the availability of the main Proxy.
Signal Failback	Multiple proxy cases, whether to allow the invite/register request to also execute failback.
Signal Retry Counts	The number of attempts that the SIP Request considers proxy unavailable under multiple proxy scenarios.
Codecs Settings	Set the priority and availability of the codecs by adding or remove them from the list.
Advanced Settings	
Use Feature Code	When this setting is enabled, the features in this section will not be handled by the device itself but by the server instead. In order to control the enabling of the features, the device will send feature code to the server by dialing the number specified in each feature code field.
Enable DND	It configures the DND on code to activate the server-side DND feature.
DND Disable	It configures the DND off code to deactivate the server-side DND feature.
Enable Call Forward Unconditional	It configures the always forward on code to activate the server-side always forward feature.
Disable Call Forward Unconditional	It configures the always forward off code to deactivate the server-side always forward feature.
Enable Call Forward on Busy	It configures the busy forward on code to activate the server-side busy forward feature.
Disable Call Forward on Busy	It configures the busy forward off code to deactivate the server-side busy forward feature.
Enable Call Forward on No Answer	It configures the no answer forward on code to activate the server-side no answer forward feature.
Disable Call Forward on No Answer	It configures the no answer forward off code to deactivate the server-side no answer forward feature.
Enable Blocking Anonymous Call	It configures the Blocking Anonymous Call On code activate the server-side Blocking Anonymous Call feature.
Disable Blocking Anonymous Call	It configures the Blocking Anonymous Call Off code deactivate the server-side Blocking Anonymous Call feature.
Call Waiting On Code	It configures the call waiting on code to activate the server-side call waiting feature.
Call Waiting Off Code	It configures the CallWaiting Off code to deactivate the server-side call waiting feature.

Send Anonymous On Code	It configures the Anonymous Call On code activate the server-side Anonymous Call feature.
Send Anonymous Off Code	It configures the Anonymous Call Off code deactivate the server-side Anonymous Call feature.
Enable Session Timer	When the call timer is enabled, when the configuration item is switched on, the phone periodically sends the message and terminates the call without a reply.
Session Timeout	Set the session timer timeout period.
Enable BLF List	Open the BLF List function.
BLF List Number	Set the BLF List number and bind the BLF List of this number to the DSS Key.
Response Single Codec	If setting enabled, the device will use single codec in response to an incoming call request.
BLF Server	The BLF server is used in conjunction with the BLF list.
Keep Alive Type	Set the line to use dummy UDP or SIP OPTION packet to keep NAT pinhole opened.
Keep Alive Interval	Set the keep alive packet transmitting interval.
Keep Authentication	Keep the authentication parameters from previous authentication.
Blocking Anonymous Call	Reject any incoming call without presenting caller ID.
RTP Encryption(SRTP)	RTP encryption. When this configuration is open, the voice of the phone is encrypted, the conversation is normal, and the phone is not heard by the grab bag.
Enable OSRTP	When RTP Encryption(SRTP) is Optional, It decides whether SRTP applies OSRTP or Optional.It is OSRTP when it is enabled, otherwise it is Optional.
User Agent	Set the user agent, the default is Model with Software Version.
Specific Server Type	Set the line to collaborate with specific server type.
SIP Version	Set the SIP version.
Anonymous Call Standard	Set the standard to be used for anonymous.
Local Port	Set the local port.
Ring Type	Set the ring tone type for the line.
Enable user=phone	Sets user=phone in SIP messages.
Use Tel Call	Set use tel call.
Auto TCP	Using TCP protocol to guarantee usability of transport for SIP messages above 1500 bytes.
Enable Rport	Set the line to add rport in SIP headers.
Enable PRACK	Set the line to support PRACK SIP message.
Call-ID Format	It configures the Call-ID Header format of SIP message. Valid input: \$id, \$id@\$ip.

DNS Mode	Select DNS mode, A, SRV, NAPTR.
Enable Long Contact	Allow more parameters in contact field per RFC 3840.
Enable Strict Proxy	Enables the use of strict routing. When the phone receives packets from the server, it will use the source IP address, not the address in via field.
Convert URI	Enable URI conversion Whether or not.
Use Quote in Display Name	Whether to add quote in display name, i.e. "Fanvil" vs Fanvil.
Enable GRUU	Support Globally Routable User-Agent URI (GRUU).
Sync Clock Time	Time Sync with server.
Enable Inactive Hold	With the post-call hold capture package enabled, you can see that in the INVITE package, SDP is inactive.
Caller ID Header	Set the Caller ID Header.
Use 182 Response for Call waiting	Set the device to use 182 response code at call waiting response.
Enable Feature Sync	Feature Sync with server.
Enable SCA	Enable/Disable SCA (Shared Call Appearance).
TLS Version	Choose TLS Version.
uaCSTA Number	Set uaCSTA Number.
Enable Preview	Whether to enable preview.
Preview Mode	Set the preview mode.
Enable Click To Talk	With the use of special server, click to call out directly after enabling.
Enable ChangePort	Whether to enable changeport.
VQ Name	Set VQ name.
VQ Server	Set VQ server.
VQ Server Port	Set VQ server port..
VQ Http/Https server	Set VQ http/https server.
Server Expire	Use the timeout of the server.
PickUp Number	Set the scramble number when the Pickup is enabled.
JoinCall Number	Set JoinCall Number.
Intercom Number	Set Intercom Number.
CallPark Number	CallPark number. Keep the call to the configured number, record the number of voice broadcasts, and then use the number of other terminal call records to retrieve the call.
Retrieve Number	Set retrieve number.
Unregister On Boot	Whether to enable logout function.
Enable MAC Header	When opening the registration, are IP package and user agent with MAC.
Enable Register MAC	When opening the registration, is user agent with MAC.

Header	
BLF Dialog Strict Match	Whether to enable accurate matching of BLF sessions.
PTime(ms)	Set whether to bring ptime field, default no.
Enable Deal 180	Set whether to enable deal 180.
Transaction Timer T1	It configures the SIP Transaction Timer T1(in millionseconds).
Transaction Timer T2	It configures the SIP Transaction Timer T2(in millionseconds).
Transaction Timer T4	It configures the SIP Transaction Timer T4(in millionseconds).
SIP Global Settings	
Strict Branch	Set up to strictly match the Branch field.
Enable Group	Set open group.
Enable RFC4475	Set to enable RFC4475.
Enable Strict UA Match	Enable strict UA matching.
Registration Failure Retry Time	Set the registration failure retry time.
Local SIP Port	Modify the phone SIP port.
Enable uaCSTA	Enable uaCSTA.
SMS direct Enabled	Set enable or disable or show only a period of time.
SMS Save Enabled	Whether to enable SMS save.
SMS Ring Enabled	Whether to enable SMS ring.
SMS Display Time	Set SMS display time.

12.6 Line >> SIP Hotspot

Please refer to [9.9 SIP Hotspot](#)

12.7 Line >> Dial Plan

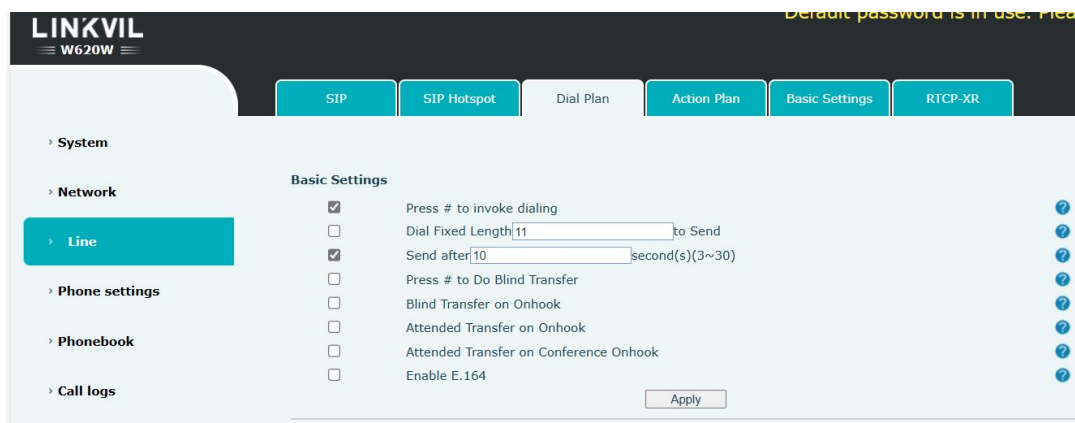

Picture 136 - Dial plan settings

Table 16 - Phone 5 dialing methods

Parameters	Description
Press # to invoke dialing	The user dials the other party's number and then adds the # number to dial out.
Press # to Do Blind Transfer	With "#" end blind transfer, enter the number in the transfer dial, then enter # for the blind transfer.
Dial Fixed Length	The number entered by the user is automatically dialed out when it reaches a fixed length.
Timeout dial	The system dials automatically after timeout.
Enable E.164	Please refer to E. 164 standard specification.

Add dialing rules:

Picture 137 - Custom setting of dial - up rules

Table 17 - Dial - up rule configuration table

Parameters	Description
Dial rule	<p>There are two types of matching: Full Matching or Prefix Matching. In Full matching, the entire phone number is entered and then mapped per the Dial Peer rules.</p> <p>In prefix matching, only part of the number is entered followed by T. The mapping with then take place whenever these digits are dialed. Prefix mode supports a maximum of 30 digits.</p>
<p>Note: Two different special characters are used.</p> <ul style="list-style-type: none"> ■ x -- Matches any single digit that is dialed. ■ [] -- Specifies a range of numbers to be matched. It may be a range, a list of ranges separated 	

by commas, or a list of digits.	
Destination	Set Destination address. This is for IP direct.
Port	Set the Signal port, and the default is 5060 for SIP.
Alias	Set the Alias. This is the text to be added, replaced or deleted. It is an optional item.
<p>Note: There are four types of aliases.</p> <ul style="list-style-type: none"> ■ all: xxx – xxx will replace the phone number. ■ add: xxx – xxx will be dialed before any phone number. ■ del: The characters will be deleted from the phone number. ■ rep: xxx – xxx will be substituted for the specified characters. 	
Suffix	Characters to be added at the end of the phone number. It is an optional item.
Length	Set the number of characters to be deleted. For example, if this is set to 3, the phone will delete the first 3 digits of the phone number. It is an optional item.

For Example

This feature allows the user to create rules to make dialing easier. There are several different options for dial rules. The examples below will show how this can be used.

Example 1: All Substitution -- Assume that it can make a direct IP call to IP address 172.168.2.208. Using this feature, 123 can be substituted for 172.168.2.208.

Index	Digit Map	Call	Match to Send	Line	Alias Type: Number(length)	Suffix	Media
1	"123"	Out	No	SIP DIALPEER(172.16.1.15:5560)			Default

Picture 138 - Dial rules table (1)

Example 2: Partial Substitution -- To dial a long distance call to Beijing requires dialing area code 010 before the local phone number. Using this feature 1 can be substituted for 010. For example, to call 62213123 would only require dialing 162213123 instead of 01062213123.

Index	Digit Map	Call	Match to Send	Line	Alias Type: Number(length)	Suffix	Media
1	"1T"	Out	No	Fanvil@SIP1	rep:010(1)		Default

Picture 139 - Dial rules table (2)

Example 3: Addition -- Two examples are shown. In the first case, it is assumed that 0 must be dialed before any 11 digit numbers beginning with 131. In the second case, it is assumed that 0 must be dialed before any 11 digit numbers beginning with 135, 136, 137, 138, or 139.

Two different special characters are used:

x -- Matches any single digit that is dialed.

[] -- Specifies a range of numbers to be matched. It may be a range, a list of ranges separated by

commas, or a list of digits.

12.8 Line >> Action Plan

Action Plan application: a technical implementation defined and designed by Fanvil for remote control and behavior linkage between Fanvil terminal equipment and other equipment. That is, when an event occurs on the Fanvil terminal, the terminal can perform an action, and this action is completed according to a Plan rule.

Log in to the phone web page, access [Line] >> [Action Plan], and configure the linkage plan rules.

Picture 140 - Action Plan

Table 18 - Action Plan

Parameter	Description
Action	<p>Default: when the rule is triggered, the phone displays video or converts multicast according to the RTSP URL or multicast address port set by the website.</p> <p>Video: when the rule is triggered, the phone accesses the RTSP URL configured by the URL to display the video.</p> <p>MCAST-XFER: when the rule is triggered, the phone converts the incoming call or multicast into multicast and sends it to the set multicast address port.</p> <p>Record: the phone automatically turns on the recording function when the rule is triggered.</p> <p>Mute: the phone will mute automatically when the rule is triggered.</p> <p>Answer: when the rule is triggered, the phone automatically answers the incoming call.</p>
Number	Auxiliary phone number.
Type	<p>Early: trigger execution before call establishment.</p> <p>Connected: trigger execution after call establishment.</p>
Direction	For call mode, incoming/outgoing call.

Line	Set up outgoing lines.
MCAST Codec	Multicast coding.
Username	Bind the user name of the IP camera.
Password	Bind IP camera password.
URL	Video streaming information or MCAST IP address.
User Agent	Set user agent information.

12.9 Line >> Basic Settings

Set up the register global configuration.

Table 19 - Set the line global configuration on the web page

Parameters	Description
STUN Settings	
Server Address	Set the STUN server address.
Server Port	Set the STUN server port, default is 3478.
Binding Period	STUN valid time.
SIP Waiting Time	Set the timeout of STUN binding before sending SIP messages.
The TLS authentication	
TLS Certification File	Upload or delete the TLS certification file used for encrypted SIP transmission.

12.10 Line >> RTCP-XR

RTCP-XR mode is based on RFC3611 (RTP Control Extended Report), which can measure and evaluate network packet loss, delay and voice quality by sending RTCP-XR packets.

Table 20 - VQ RTCP-XR Settings

Parameters	Description
VQ RTCP-XR Settings	
VQ RTCP-XR Session Report	VQ report on whether session mode is enabled or not.
VQ RTCP-XR Interval Report	Whether to turn on Interval mode for VQ report sending.
Period for Interval Report(5~99)	The time interval at which VQ reports are sent periodically.
Warning threshold for Moslq(15~40)	When the phone calculated the Moslq value x10 below the set threshold, a warning was issued.
Critical threshold for Moslq(15~40)	When the phone calculates the Moslq value x10 below the set threshold, the critical report is issued.
Warning Threshold for Delay(10~2000)	When the one-way delay of the phone is greater than the

	set threshold, warning is issued.
Critical Threshold for Delay(10~2000)	When the phone computes that the one-way delay is greater than the set threshold, the critical report is issued.
Display Report Options on Phone	Whether to display the VQ report data of the last call on the phone.
Display Report Options on web	Whether to display the VQ report data for the last call through the web page.

12.11 Phone settings >> Features

Configuration phone features.

Table 21 - General function Settings

Parameters	Description
Basic Settings	
Enable Call Waiting	Enable this setting to allow user to take second incoming call during an established call. Default enabled.
Enable Call Transfer	Enable Call Transfer.
Semi-Attended Transfer	Enable Semi-Attended Transfer by selecting it
Enable 3-Way Conference	Enable 3-way conference by selecting it
Enable Auto Onhook	The phone will hang up and return to the idle automatically at hands-free mode
Auto HangUp Delay	enable Auto hangUp delay.
Auto HangUp Tone	auto HangUp Tone.
Busy HangUp Delay	When the receiving line is busy, the delay time setting for automatically returning to standby.
Ring from Headset	Enable Ring for Handset by selecting it, the phone plays ring tone from handset.
Enable Auto Headset	Enable this feature, headset plugged in the phone, user press 'answer' key or line key to answer a call with the headset automatically.
Enable Silent Mode	When enabled, the phone is muted, there is no ringing when calls, you can use the volume keys and mute key to unmute.
Disable Mute for Ring	When it is enabled, you can't mute the phone
Enable Default Line	If enabled, user can assign default SIP line for dialing out rather than SIP1.
Enable Auto Switch Line	Enable phone to select an available SIP line as default automatically
Default Ext Line	Select the default line to use for outgoing calls
Ban Outgoing	If you select Ban Outgoing to enable it, and you cannot dial out any number.

Hide DTMF	Configure the hide DTMF mode.
Enable CallLog	Select whether to save the call log.
Enable Restricted Incoming List	Whether to enable restricted call list.
Enable Allowed Incoming List	Whether to enable the allowed call list.
Enable Restricted Outgoing List	Whether to enable the restricted allocation list.
Enable Country Code	Whether the country code is enabled.
Country Code	Fill in the country code.
Area Code	Fill in the area code.
Enable Number Privacy	Whether to enable number privacy.
Match Direction	Matching direction, there are two kinds of rules from right to left and from left to right.
Start Position	Open number privacy after the start of the hidden location.
Hide Digits	Turn on number privacy to hide the number of digits.
Enable DTMF / Transfer	Enable DTMF / Transfer
Enable DTMF / Hold	Enable DTMF / Hold
Enable DTMF / Conference	Enable DTMF / Conference
Allow IP Call	If enabled, user can dial out with IP address.
P2P IP Prefix	Prefix a point-to-point IP call.
Caller Name Priority	Change caller ID display priority.
Search path	Select the search path.
LDAP Search	Select from with one LDAP for search.
Caller Display Type	Caller Display.
Emergency Call Number	Configure the Emergency Call Number. Despite the keyboard is locked, you can dial the emergency call number.
Restrict Active URI Source IP	Set the device to accept Active URI command from specific IP address.
Push XML Server	Configure the Push XML Server, when phone receives request, it will determine whether to display corresponding content on the phone which sent by the specified server or not.
Enable Pre-Dial	Disable this feature, user enter number will open audio channel automatically. Enable the feature, user enter the number without opening audio channel.
Enable Multi Line	If enabled, up to 10 simultaneous calls can exist on the phone, and if disabled, up to 2 simultaneous calls can exist on the phone.

Line Display Format	Custom line format: SIPn/SIPn: xxx/xxx@SIPn
Contact As Allowed List Type	Contact As AllowedList Type.
Block XML When Call	Disable XML push on call.
SIP notify	When enabled, the phone displays the information when it receives the relevant notify content.
Call Number Filter	Set call Number Filter.
Auto Resume Current	Resume automatically when the current call changes.
Call Timeout	The remote phone does not answer within the time, the local automatically hangs up.
Ring Timeout	It configures ringing time of incoming call.
Enable Push XML Auth	Enabled authentication when push xml.
Display BLF PickUp Popup	When there is an incoming call on the subscribed BLF number, Whether display the call prompt interface.
Play BLF PickUp Tone	When there is an incoming call on the subscribed BLF number, whether to play prompt tone.
Ring Type For BLF PickUp	When there is an incoming call on the subscribed BLF number, the phone plays the ring tone type.
Ring Priority	It configures the priority of incoming call.
Enable Display To Info	Display information about the to field.
Tone Settings	
Enable Holding Tone	When turned on, a tone plays when the call is held.
Enable Call Waiting Tone	When turned on, a tone plays when call waiting.
Play Dialing DTMF Tone	Play DTMF tone on the device when user pressed a phone digits at dialing, default enabled.
Play Talking DTMF Tone	Play DTMF tone on the device when user pressed a phone digits during taking, default enabled.
Auto Answer Tone	Whether enable auto answer tone.
Low Battery Tone	Whether enable battery low tone.
Ring Back Tone	Configure ring back tone.
Busy Tone	Configure busy tone.
DND Settings	
DND Option	Select to take effect on the line or on the phone or close.
Enable DND Timer	Enable DND Timer, If enabled, the DND is automatically turned on from the start time to the off time.
DND Start Time	Set DND Start Time.
DND End Time	Set DND End Time.
Intercom Settings	

Enable Intercom	When intercom is enabled, the device will accept the incoming call request with a SIP header of Alert-Info instruction to automatically answer the call after specific delay.
Enable Intercom Mute	Enable mute mode during the intercom call.
Enable Intercom Tone	If the incoming call is intercom call, the phone plays the intercom tone.
Enable Intercom Barge	Enable Intercom Barge by selecting it, the phone auto answers the intercom call during a call. If the current call is intercom call, the phone will reject the second intercom call
Redial Settings	
Enable Call Completion	Enable call completed to redial.
Enable Auto Redial	Enable auto redial.
Auto Redial Interval	Auto redial Interval.
Auto Redial Times	Auto redial times.
Response Code Settings	
DND Response Code	Set the SIP response code on call rejection on DND.
Busy Response Code	Set the SIP response code on line busy.
Reject Response Code	Set the SIP response code on call rejection.
Bluetooth Settings	
Enable Bluetooth	Whether to enable Bluetooth.
Bluetooth Name	Bluetooth name.
Password Dial Settings	
Enable Password Dial	Enable Password Dial by selecting it, When number entered is beginning with the password prefix, the following N numbers after the password prefix will be hidden as *, N stand for the value which you enter in the Password Length field. For example: you set the password prefix is 3, enter the Password Length is 2, then you enter the number 34567, it will display 3**67 on the phone.
Encryption Number Length	Configure the Encryption Number length.
Password Dial Prefix	Configure the prefix of the password call number.
Power LED	
Common	Standby power lamp state, off when off, open is always bright red. Off by default.
SMS/MWI	The status of power lamp when there is unread short message/voice .message, including off/on/slow flash/quick flash, default slow flash.
Missed	The state of the power lamp when there is a missed call, including off/on/slow flash/quick flash, the default slow flash.
Talk/Dial	In the talk/dial state, the power lamp state, off is off, on is always red

	bright, the default is off.
Ringling	Power lamp status when there is an incoming call, including off/on/slow flash/quick flash, default flash.
Mute	Power lamp status in mute mode, including off/on/slow flash/quick flash, off by default.
Hold/Held	The power lamp state, including off/on/slow flash/quick flash, is turned off by default when left/retained.
Notification Popups	
Display Missed Call Popup	No incoming call popup prompt after opening, no popup prompt when closing, open by default.
Display Voice Mail Popup	Display voice mail popup.
Display SMS Popup	There is popup prompt for unread messages after opening, and there is no popup prompt when closing. It is opened by default.
Display Other Popup	When the handle is not hung back after opening, registration fails, IP acquisition fails, Tr069 connection fails and other abnormalities, there will be popup prompt when it is opened; otherwise, there will be no prompt when it is closed, and it will be opened by default.

12.12 Phone settings >> Media Settings

Change voice Settings.

Table 22 - Voice settings

Parameters	Description
Codecs Settings	Select enable or disable voice encoding: G.711A/U, G.722, G.729AB, G.726-16, G726-24, G726-32, G.726-40, G723.1, iLBC, Opus
Noise Reduction	
A.I Noise Reduction Technology	Whether to enable A.I noise reduction technology.
Acoustic Shield	Whether to enable acoustic shield.
Media Settings	
Handset Volume	Set the handset volume, the value must be 1~9.
Default Ring Type	Configure default ringtones. If no special ringtone is set for the phone number, the default ringtone will be used.
Speakerphone Volume	Set the hands-free volume to 1-9.
Headset Ring Volume	Set the volume of the headset ringtone to 1~9.
Headset Volume	Set the volume of the headset to 1~9.

Speakerphone Ring Volume	Set the volume of hands-free ringtone to 1~9.
DTMF Payload Type	Enter the DTMF payload type, the value must be 96~127.
Headset Mic Gain	Set the Headset's radio volume gain to fit different models of headsets.
Handset Mic Gain	Set the Handset's radio volume gain to fit different models of headsets.
Handfree Mic Gain	Set the Handfree's radio volume gain to fit different models of headsets.
Opus Payload Type	Set Opus load type, range 96~127.
Opus Sample Rate	Set Opus sampling rate, including opus-nb (8KHz) and opus-wb (16KHz).
ILBC Payload Type	Set the ILBC Payload Type, the value must be 96~127.
ILBC Payload Length	Set the ILBC Payload Length.
Enable VAD	Whether voice activity detection is enabled.
Enable Voice Mail Tone	It enables or disables the IP phone to play voice message tone when dialing.
Enabled Vibrate	Whether to enable vibrate.
RTP Control Protocol(RTCP) Settings	
CNAME user	Set CNAME user
CNAME host	Set CNAME host
RTP Settings	
RTP keep alive	Hold the call and send the packet after 30 s.
RTP Relay	Set RTP Relay.
Alert Info Ring Settings	
Value	Set the value to specify the ring type.
Line	Set the line to specify the ring type.
Ring Type	Set ring type.

12.13 Phone settings >> MCAST

This feature allows user to make some kind of broadcast call to people who are in multicast group. User can configure a multicast DSS Key on the phone, which allows user to send a Real Time Transport Protocol (RTP) stream to the pre-configured multicast address without involving SIP signaling. You can also configure the phone to receive an RTP stream from pre-configured multicast listening address without involving SIP signaling. You can specify up to 10 multicast listening addresses.

Table 23 - Multicast parameters

Parameters	Description
SIP Priority	Define the priority of the active call, 1 is the highest priority, 10 is the lowest.
Intercom Priority	Set intercom priority.
Enable Page Priority	The voice call in progress shall take precedence over all incoming paging calls.

PTT MCAST Standby Sync	Set PTT MCAST standby sync.
Enable Prio Chan	Once enabled, only the same port and channel can be connected. Channel 24 is the priority channel, which takes precedence over channels 1-23; a channel value of 0 indicates that no channel is used.
Mcast Listening Renew Time	Set the waiting duration for re-listening to Mcast.
Enable Emer Chan	Once enabled, channel 25 will have the highest priority.
Name	Listened multicast server name
Host: port	Listened multicast server's multicast IP address and port.
Channel	Set channel.0-25

12.14 Phone settings >> Action

Action URL

Action URL is used for IPPBX systems to submit phone events.

12.15 Phone settings >> Time/Date

The user can configure the time Settings of the phone on this page.

Table 24 - Time&Date settings

Parameters	Description
Network Time Server Settings	
Time Synchronized via SNTP	Enable time-sync through SNTP protocol.
Time Synchronized via DHCP	Enable time-sync through DHCP protocol.
Time Synchronized via DHCPv6	It enables or disables the IP phone to update time with the offset time offered by the DHCP server.
Primary Time Server	Set primary time server address.
Secondary Time Server	Set secondary time server address, when primary server is not reachable, the device will try to connect to secondary time server to get time synchronization.
Time Zone	Select the time zone.
Resync Period	Time of re-synchronization with time server.
Dynamically Display Time	Whether to enable dynamically display time.
Time/Date Format	
12-Hour clock	Set the time display in 12-hour mode.
Time/Date Format	Select the time/date display format.
Daylight Saving Time Settings	

Location	Choose your local, phone will set daylight saving time automatically based on the local.
DST Set Type	Choose DST Set Type, if Manual, you need to set the start time and end time.
Fixed Type	Daylight saving time rules are based on specific dates or relative rule dates for conversion. Display in read-only mode in automatic mode.
Offset	The offset minutes when DST started.
Month Start	The DST start month.
Week Start	The DST start week.
Weekday Start	The DST start weekday.
Hour Start	The DST start hour.
Minute Start	The DST start minute.
Month End	The DST end month.
Week End	The DST end week.
Weekday End	The DST end weekday.
Hour End	The DST end hour.
Minute End	The DST end minute.
Manual Time Settings	You can set your time manually.

12.16 Phone settings >> Time Plan

Time Plan (time management) settings can set a time point or a time period. The time point is to perform an action at a certain time, and the time period is to perform an action for a certain period of time.

Time Plan:

Name:

Type:

Repetition period:

Monthly: 1
 2
 3
 4
 5
 6
 7
 8
 9
 10

Start Date:

End Date:

Effective time: : : - : :

Time Plan List: [?](#)

<input type="checkbox"/>	Index	Name	Type	Special configure	Repetition period	Start Date	End Date	Effective time
<input type="button" value="Delete"/>								

Picture 141 - Time Plan (1)

Table 25 - Time Plan

configure	Value	Description
Time plan Type	1: Timed reboot 2: Timed upgrade 3: Timed forward 4: Timed config	Type , Action performed at a time point/time period.
Repetition period	0: No repetition 1: Daily 2: Weekly 3: Monthly	repeat type
in weeks	0-6: Sunday-Saturday, supports multiple separated by ";" 1-31: 1-31 day	When the repetition type is daily/non-repeating, the value is empty
in days	XX:XX-XX:XX	start time - end time period

When the Time Plan type is selected as timed forwarding, the web page will prompt to enter the forwarding number and forwarding line, as shown in the figure.

Time Plan:

Name:

Type:

Repetition period:

Monthly: 1
 2
 3
 4
 5
 6
 7
 8
 9
 10

Start Date:

End Date:

Effective time: : : - : :

Picture 142 - Time Plan (2)

Forwarding Number: Configure the forwarding number to forward to the number within the set time period.
 Line: Forward the specified line, when the line is set to a certain line, it will only take effect for this line.

1. Timed forwarding rules:

1) When there is forwarding under the line, the forwarding number under the line is used; when there is no forwarding number under the SIP line, when there is an incoming call within the time period set by the scheduled forwarding, the phone will be forwarded to the specified scheduled forwarding number; when outside the time period, no forwarding is performed. That is, the priority Line>Time Plan.

2) All scheduled forwarding types are unconditional forwarding.

12.16.1 Repeat Period Select Daily

Select daily as the repetition period, and enter any time in the date format from 00:00 to 23:59 in the effective time input box.

The first and third input boxes only allow input of any integer from 00 to 23, and 0 is automatically added before inputting an integer less than 10.

The second and fourth input boxes only allow input of any integer from 00 to 59, and 0 is automatically added before inputting an integer less than 10.

Repetition period:

Start Date:

End Date:

Effective time: : : - : :

Picture 143 - Time Plan (3)

12.16.2 Repeat Period Select Weekly

Day of the week selection box, check it to take effect.

The final effective time is the combination of the day of the week and the set time.

Repetition period:

Weekly: Sunday
 Monday
 Tuesday
 Wednesday
 Thursday
 Friday
 Saturday

Start Date:

End Date:

Effective time: : : - : :

Picture 144 - Time Plan (4)

12.16.3 Time Plan List

All configurations submitted after the configuration is submitted are displayed in a list, and the order is sorted by week (day, Monday, Tuesday...), and if the week is the same, it is sorted by time (time from small to large). The function sequence is restarted first and then upgraded.

Time Plan List:

<input type="checkbox"/>	Index	Name	Type	Special configure	Repetition period	Start Date	End Date	Effective time
<input type="checkbox"/>	1		Timed reboot		Daily	2025-08-13	2025-08-31	1:2:0-3:3:0
<input type="checkbox"/>	2		Timed reboot		No repetition	2025-08-18		9:0:0-18:0:0

Picture 145 - Time Plan (5)

12.16.4 Delete

Check the box before the serial number, click to select all configuration items in the list.

Click Delete to delete the checked configuration in the configuration list, and it will become invalid after deletion.

Time Plan List: [?](#)

<input type="checkbox"/>	Index	Name	Type	Special configure	Repetition period	Start Date	End Date	Effective time
<input checked="" type="checkbox"/>	1		Timed reboot		Daily	2025-08-13	2025-08-31	1:2:0-3:3:0
<input checked="" type="checkbox"/>	2		Timed reboot		No repetition	2025-08-18		9:0:0-18:0:0

Picture 146 - Time Plan (6)

12.17 Phone settings >> Tone

This page allows users to configure a phone prompt.

You can either select the country area or customize the area. If the area is selected, it will bring out the following information directly. If you choose to customize the area, you can modify the key tone, call back tone and other information.

Tone Settings

Select Your Tone: [?](#)

Dial Tone: [?](#)

Ring Back Tone: [?](#)

Busy Tone: [?](#)

Congestion Tone: [?](#)

Call waiting Tone: [?](#)

Holding Tone: [?](#)

Error Tone: [?](#)

Stutter Tone: [?](#)

Information Tone: [?](#)

Dial Recall Tone: [?](#)

Message Tone: [?](#)

Howler Tone: [?](#)

Number Unobtainable Tone: [?](#)

Warning Tone: [?](#)

Record Tone: [?](#)

Auto Answer Tone: [?](#)

Picture 147 - Tone settings on the web

12.18 Phone settings >> Advanced

User can configure the advanced configuration settings in this page.

- Screen Configuration.
 - Enable Energy Saving
 - Backlight Time
 - Timeout to Sleep
- UI Preference
 - Set font, color, and screensaver display

- LCD Menu Password Settings.
The password is 123 by default.
- Keyboard Lock Settings.
- Greeting Words

The greeting message will display on the top left corner of the LCD when the device is idle, which is limited to 16 characters. The default chars are 'VOIP PHONE'.

12.19 Phonebook >> Contact

User can add, delete, or edit contacts in the phonebook in this page. User can browse the phonebook and sorting it by name, phones, or filter them out by group.

To add a new contact, user should enter contact's information and press "Add" key to add it.

To edit a contact, click on the checkbox in front of the contact, the contact information will be copied to the contact edit boxes, press "Modify" key after finished editing.

To delete one or multiple contacts, check on the checkbox in front of the contacts wished to be deleted and click the "Delete" key, or click the "Clear" key with selecting any contacts to clear the phonebook.

User can also add multiple contacts into a group by selecting the group in the dropdown options in front of "Add to Group" key at the bottom of the contact list, selecting contacts with checkbox and click "Add to Group" to add selected contacts into the group.

Similarly, user can select multiple users and add them into Blocked List by click "Add to Blocked List" key.

12.20 Phonebook >> cloud contacts

cloud contacts

User can configure up to 4 cloud contacts. Each cloud contacts must be configured with an URL where an XML phonebook is stored. The URL may be based on HTTP/HTTPS or FTP protocol with or without authentication. If authentication is required, user must configure the username and password.

To configure a cloud contacts, the following information should be entered,

- Cloud Contacts name (must)
- Cloud Contacts URL (must)
- Authentication username (optional)
- Authentication password (optional)

LDAP Settings

The cloud contacts allows user to retrieve contact list from a LDAP Server through LDAP protocols.

User must configure the LDAP Server information and Search Base to be able to use it on the device. If the LDAP server requests an authentication, user should also provide username and password.

To configure a LDAP phonebook, the following information should be entered,

- Display Title (must)
- LDAP Server Address (must)
- LDAP Server Port (must)

- Search Base (must)
- Access username (optional)
- Access password (optional)

Web page preview

Phone page supports preview of Internet phone directory and contacts

- After setting up the XML directory or LDAP,
- Select [Phonebook] >> [cloud contacts] >> [cloud contacts] to select the type.
- Click the set XML/LDAP to download the contact for browsing.

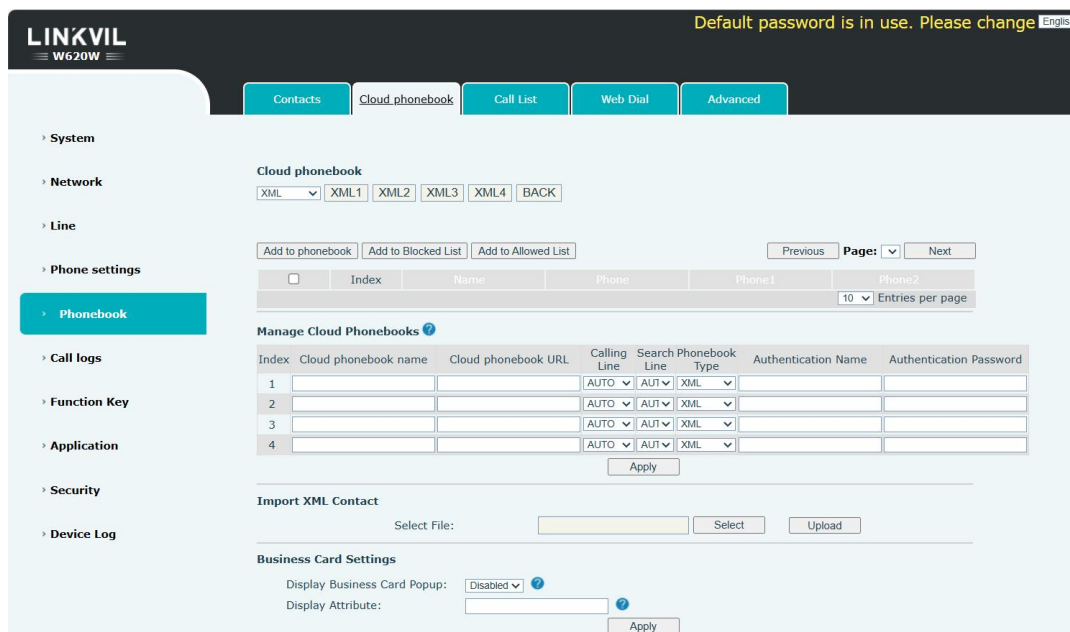

Picture 148 - Web cloud phone book Settings

12.21 Phonebook >> Call List

■ Restricted Incoming Calls:

It is similar like a Blocked List. Add the number to the Blocked List, and the user will no longer receive calls from the stored number until the user removes it from the list.

Users can add specific Numbers to the Blocked List or add specific prefixes to the Blocked List to block calls with all Numbers with this prefix.

■ Allowed Incoming Calls:

When DND is enabled, the incoming call number can still be called.

■ Restricted Outgoing Calls:

Adds a number that restricts outgoing calls and cannot be called until the number is removed from the table.

12.22 Phonebook >> Web Dial

Use web pages for call, reply, and hang up operations.

12.23 Phonebook >> Advanced

Users can export the local phone book in XML, CSV, and VCF format and save it on the local computer.

Users can also import contacts into the phone book in XML, CSV, and VCF formats.

Attention! If the user imports the same phone book repeatedly, the same contact will be ignored. If the name is the same but the number is different, the contact is created again.

Users can delete groups or add new groups on this page. Deleting a contact group does not delete contacts in that group.

12.24 Call Log

The user can browse the complete call record in this page. The call record can be sorted by time. Call number, contact name or line, and the call record can be screened by call record type (incoming call, outgoing call, missed call, forward call).

The user can also save the number in the call record to his/her phone book or add it to the Blocked List/whitelist.

Users can also dial the web page by clicking on the number in the call log.

12.25 Function Key >> Function Key

One-key transfer Settings: establish new call, blind transfer, attention-transfer, one-key three-way, Play DTMF.

The device provides multiple user-defined shortcut keys, and the user can configure each shortcut key on the web page.

Table 26 - Function Key configuration

Parameters	Description
Memory Key	<p>BLF (New Call/BXFE /AXFER): It is used to prompt user the state of the subscribe extension, and it can also pick up the subscribed number, which help user monitor the state of subscribe extension (idle, ringing, a call). There are 3 types for one-touch BLF transfer method.</p> <p>p.s. User should enter the pick-up number for specific BLF key to fulfill the pick-up operation.</p> <p>Presence: Compared to BLF, the Presence is also able to view whether the user is online. Note: You cannot subscribe the same number for BLF and Presence at the same time</p> <p>Speed Dial: You can call the number directly which you set. This feature is convenient for you to dial the number which you frequently dialed.</p> <p>Intercom: This feature allows the operator or the secretary to connect the phone quickly; it is widely used in office environments.</p> <p>Voice Mail: Used to configure voice mail numbers and lines. When the indicator light is</p>

	<p>on, it indicates that there is new voice information.</p> <p>Call Park: Used to switch to other devices or locations during a call.</p> <p>Call forward: After the configuration, you can press this key to enable Call Forward Unconditional to a specified number when the device is idle. When the device receives an incoming call, press this key to forward the call to a specified number.</p>
BLF List Key	<p>This function depends on the Broadsoft server. Add the numbers that need to be subscribed to in the server to the group, use the URL address of the group to subscribe to all the numbers in the group, and display the corresponding number, name, and status on the indicator light of the BLF List key. The BLF List is automatically issued by the server based on configuration, without the need for users to manually configure values and names.</p>
Key Event	<p>User can select a key event as a shortcut to trigger.</p> <p>For example: Voice Mail / Do - not - disturb / Call hold / Call transfer / Phonebook / Redial / Pickup / Join / Call forward / Call Logs / Flash / Memo / Headset / Release / Lock phone / SMS / Call Back / Hide DTMF / Intercom / Group Listening / Prefix / Hot Desking / Agent / End / Disposition / Escalate / Trace / Handfree / Answer Key / Private Hold / Local Contacts / LDAP Group / XML Group / Broadsoft Group / Record / Auto Headset / Acoustic Shield / Noise Reduction / DSS Key Page1 / DSS Key Page2.</p>
DTMF	<p>Press this key during a call to send the configured values in sequence to the remote end.</p>
URL	<p>Access the configured remote URL address, which can be set to an XML phone book address, etc.</p>
Multicast Paging	<p>Configure the multicast address and audio codec. User presses the key to initiate the multicast.</p>
XML browser	<p>Users can set the DSS Key for specific URL download and other operations.</p>
PTT	<p>Users can set PTT one key call to realize the function of pressing and holding the call and releasing the hang up.</p>

12.26 Function Key >> Softkey

The User Settings mode and display style, display page.

Table 27 - Softkey configuration

Parameter	Description
Softkey Mode	
Softkey mode	Disabled and More, Default is More
Softkey Style	
Softkey display style	Softkey Exit on Left or Right
Screen	

Call Dialer	Redial / 2aB / Delete / Exit / Call Back / Dial / Join / MWI / Local Contacts / Pickup / Call Log / Missed / Clear / In / Dialed / Pause / Next line / Prev line / Headset / Audio / Video / Remote XML / DSS Key
Conference(Conf)	Hold / Split / End /Release / Mute / DSS Key / Headset
Desktop	Call Log / Menu / Local Contacts / DND / Prev Account / Next Account / Blocked List / Call Back / Call Forward / Locked / Memo / Missed / MWI / Dialed / Reboot / Redial / Remote XML / SMS / Headset / Status / DSS Key / In
Divert Dialer	Redial / 2aB / Delete / Exit / Forward / Local Contacts / Call Log / Clear / Missed / Dialed / Headset / Video / Audio / Remote XML / DSS Key
Ending	Redial / End / Headset / Release / DSS Key
Predictive Dialer	Dial / 2aB / Delete / Exit / Call Back / Local Contacts / Redial / Pickup / MWI / Join / Call Log / Release / Missed / Pause / Dialed / Headset / Video / Audio / Remote XML / DSS Key / In / Next line / Prev line
Ringing	Answer / Forward / Reject / Mute / Release / Headset / Video / Audio / DSS key
Talking	Hold / Transfer / Conference / End / Mute / Release / New Call / Local Contacts / Listen / Call Log / Next call / Prev call / Private / Headset / Video / Audio / DSS Key
Transfer Alerting	End / Transfer / Headset / Release / DSS Key
Transfer Dialer	Redial / Delete / Exit / 2aB / Dial / Local Contacts / Transfer / Call Log / Clear / Missed / Dialed / Pause / Headset / Video / Audio / Remote XML / DSS Key
Trying	End / Release / Headset / DSS Key
Waiting	Hold / Transfer / Conference / End / Answer / Forward / Mute / Next call / New call / Prev call / Reject / Release / Headset / Listen / Video / Audio / DSS Key

12.27 Function Key >> Advanced

One key transfer: for example, set the memory key 4370. Press the memory key when talking with 4374 to decide whether to call 4370 or transfer 4374 to 4370.

Select memory key function: for example, the phone set the memory key value to 4370. When 4370 calls, press this key to hold the call or hang up.

■ Global Key Settings

The screenshot shows a configuration window titled "Global Key Settings". It contains two dropdown menus: "Select MemoryKey Action" is set to "None" and "Display Parked Info" is set to "Display Blank". There is a blue question mark icon next to the first dropdown and an "Apply" button at the bottom center.

Picture 149 - Global Key Settings

■ Programmable key Settings

Please refer to [Table 27 - Softkey configuration](#).

12.28 Application >> Manage Recording

See [9.4Record](#) for details of recording.

12.29 Security >> Web Filter

The user can set up a configuration management phone that allows only machines with a certain network segment IP access.

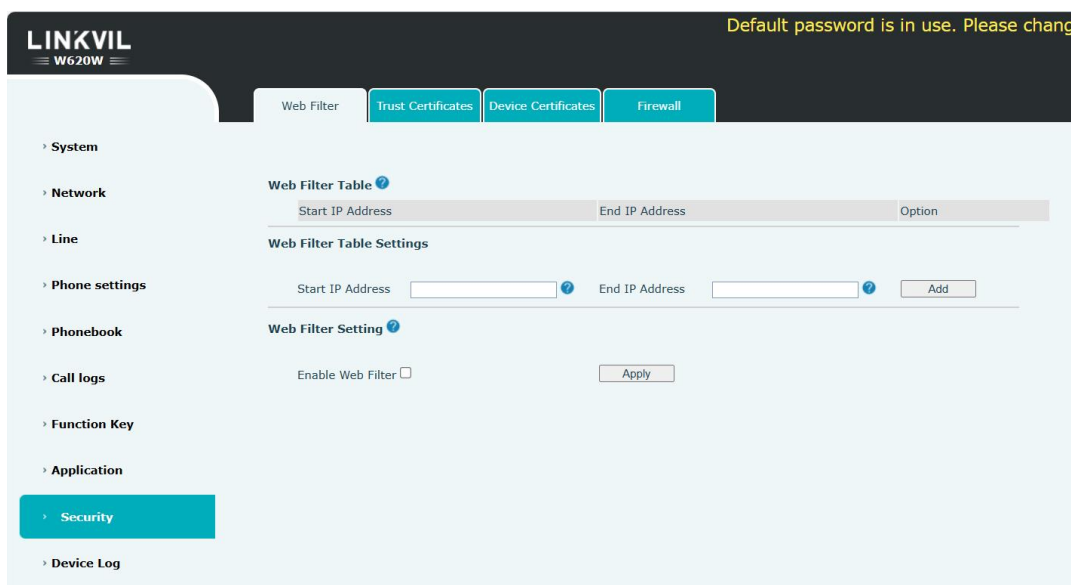

Picture 150 - Web Filter settings



Picture 151 - Web Filter Table

Adding and removing IP segments are accessible. Configure the starting IP address within the start IP, end the IP address within the end IP, and click [Add] to submit to take effect. A large network segment can be set, or it can be divided into several network segments to add. If the user wants to delete, select the initial IP of the network segment to be deleted from the drop-down menu, and then click [Delete] to take effect.

Enable web page filtering: configure enable/disable web page access filtering; Click the [apply] key to take effect.

Note: if the device you are accessing is in the same network segment as the phone, please do not configure the filter segment of the web page to be outside your own network segment, otherwise you will not be able to log in the web page.

12.30 Security >> Trust Certificates

Set whether to open license certificate and general name validation, select certificate module.

You can upload and delete uploaded certificates.

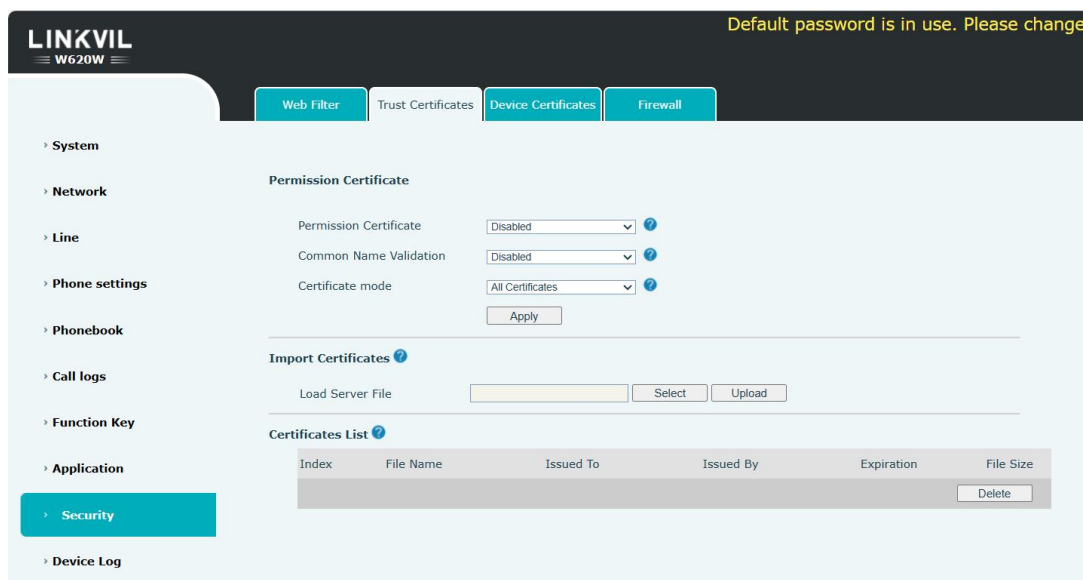

Picture 152 - Certificate of settings

12.31 Security >> Device Certificates

Select the device certificate as the default and custom certificate.

You can upload and delete uploaded certificates.

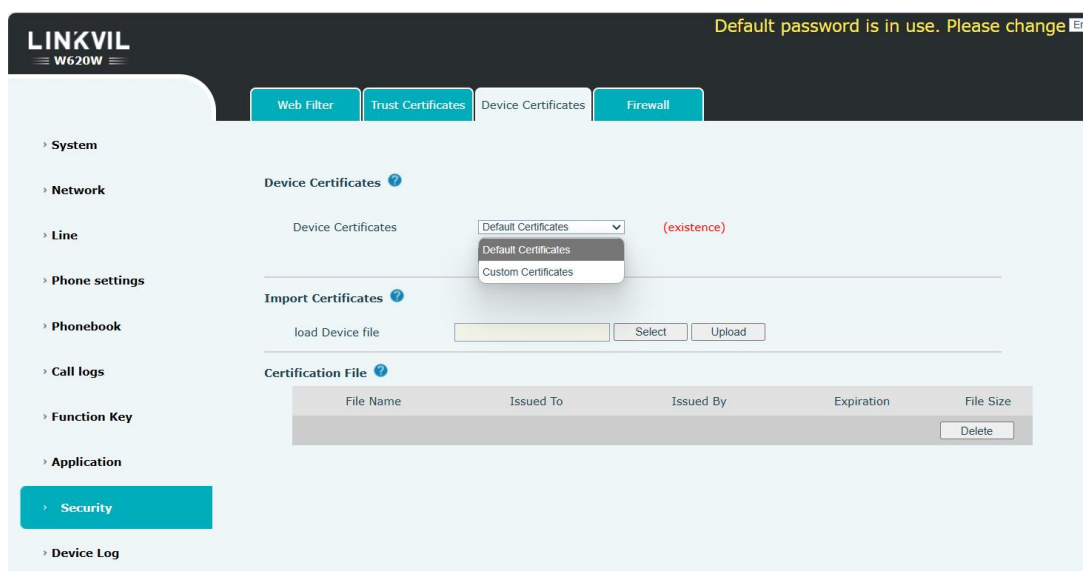

Picture 153 - Device certificate setting

12.32 Security >> Firewall

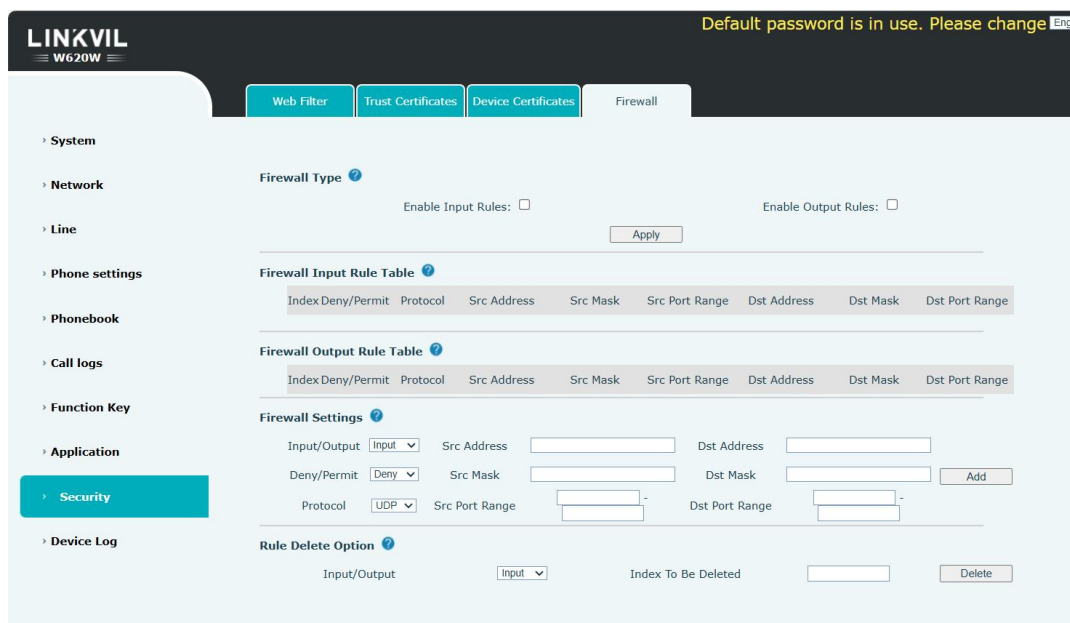

Picture 154 - Network firewall Settings

The user can set whether to enable the input through this page, output firewall and set the firewall input and output rules. Using these Settings can prevent some malicious network access, or restrict internal users access to some resources of the external network, which can improve security.

Firewall rule set is a simple firewall module. This feature supports two types of rules: input rules and output rules. Each rule is assigned an ordinal number, allowing up to 10 for each rule. Considering the complexity of firewall Settings, the following is an example to illustrate:

Table 28 - Network Firewall

Parameter	Description
Enable Input Rules	Indicates that the input rule application is enabled.
Enable Output Rules	Indicates that the output rule application is enabled.
Input/Output	To select whether the currently added rule is an input or output rule.
Deny/Permit	To select whether the current rule configuration is disabled or allowed;
Protocol	There are four types of filtering protocols: TCP UDP ICMP IP.
Src Port Range	Filter port range
Src Address	Source address can be host address, network address, or all addresses 0.0.0.0; It can also be a network address similar to *.*.*.0, such as: 192.168.1.0.
Dst Address	The destination address can be either the specific IP address or the full address 0.0.0.0; It can also be a network address similar to *.*.*.0, such as: 192.168.1.0.
Src Mask	Is the source address mask. When configured as 255.255.255.255, it means that the host is specific. When set as 255.255.255.0, it means that a network segment is filtered.

Dst Mask	Is the destination address mask. When configured as 255.255.255.255, it means the specific host. When set as 255.255.255.0, it means that a network segment is filtered.
----------	--

After setting, click [Add] and a new item will be added in the firewall input rule, as shown in the figure below:

Index	Deny/Permit	Protocol	Src Address	Src Mask	Src Port Range	Dst Address	Dst Mask	Dst Port Range
1	deny	udp	192.168.1.0	192.168.1.154	0-9	255.255.255.0	255.255.255.0	0-9

Picture 155 - Firewall Input rule table

Then select and click the key [Apply].

In this way, when the device is running: ping 192.168.1.118, the packet cannot be sent to 192.168.1.118 because the output rule is forbidden. However, the other IP of the ping 192.168.1.0 network segment can still receive the response packet from the destination host normally.

Rule Delete Option

Input/Output: Index To Be Deleted:

Picture 156 - Delete firewall rules

Select the list you want to delete and click [Delete] to delete the selected list.

12.33 Device Log >> Device Log

You can grab the device log, and when you encounter an abnormal problem, you can send the log to the technician to locate the problem. See [13.7 Get log information](#).

13 Trouble Shooting

When the phone is not in normal use, the user can try the following methods to restore normal operation of the phone or collect relevant information and send a problem report to Fanvil technical support mailbox.

13.1 Get Device System Information

Users can get information by pressing [OK] key in phone's standby mode to enter menu >> [Status] option in the phone. The following information will be provided:

The network information, Equipment information (model, software and hardware version), The account information, TR069, RTP.

13.2 Power on/off

Boot up operation

- Long press the red on-hook key  until it boots up.
- Connect the charging base and it will automatically boot up.

Shutdown operation

- Shutdown: Long press the red on-hook key  to pop up a shutdown window and select whether to shut down.
- Automatic shutdown when low battery: When the battery is about to run out, it prompts "Low battery". The device automatically shuts down when the battery is depleted.

13.3 Reboot Device

Users can reboot the device from soft-menu, press [OK] in phone's standby mode to enter menu >> [Basic] >> [Reboot System], and confirm the action by [OK]. Or long press the [red on-hook key ] to reboot.

13.4 Reset Device to Factory Default

Resetting Device to Factory Default will erase all the user's configuration, preference, database and profiles on the device and restore the device back to the state as factory default.

To perform a factory default reset, user should press [OK] key in phone's standby mode to enter menu >> [Advanced] , and then input the password to enter the interface. Then choose [Factory Reset] and confirm the action by [OK] or long press the OK key on the standby interface of W620W. The device will be rebooted into a clean factory default state.

13.5 Screenshot

If there is a problem with the phone, the screenshot can help the technician locate the function and

identify the problem. In order to obtain screen shots, log in the phone web page [System] >> [Tools], and you can capture the pictures of the main screen and the secondary screen (you can capture them in the interface with problems).

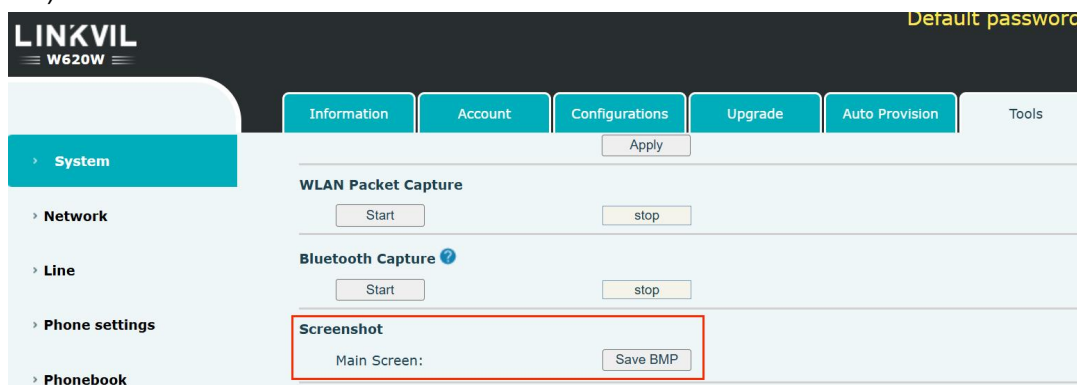

Picture 157 - Screenshot

13.6 Network Packets Capture

Sometimes it is helpful to dump the network packets of the device for issue identification. To get the packets dump of the device, user needs to log in the device web portal, open page [System] >> [Tools] and click [Start] in “Network Packets Capture” section. A pop-up message will be prompt to ask user to save the capture file. User then should perform the relevant operations such as activating/deactivating line or making phone calls and click [Stop] key in the web page when operation finished. The network packets of the device during the period have been dumped to the saved file.

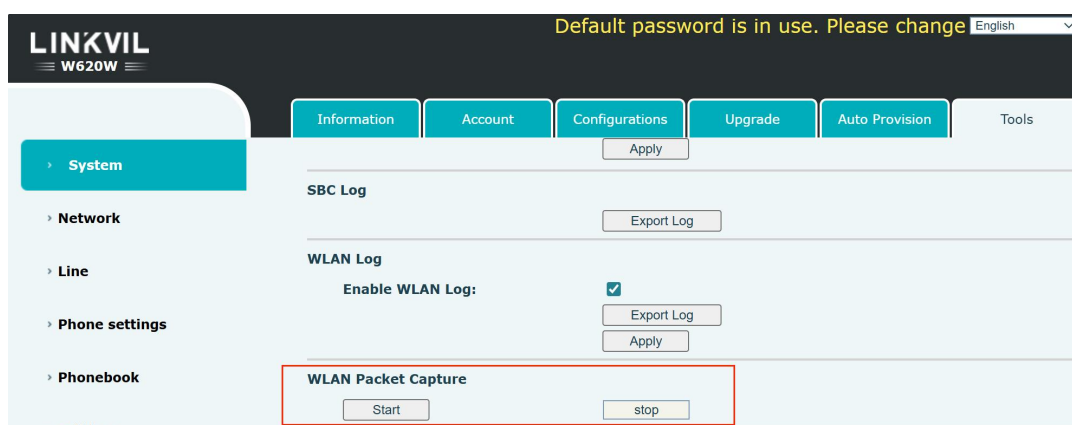

Picture 158 - Web capture

User may examine the packets with a packet analyzer or send it to Fanvil support mailbox.

13.7 Get Log Information

Log information is helpful when encountering an exception problem. In order to get the log information of the phone, the user can log in the phone web page, open the page [System] >> [Tools] >> [WLAN Log], check [Enable WLAN Log], click [Export Log] to export log.

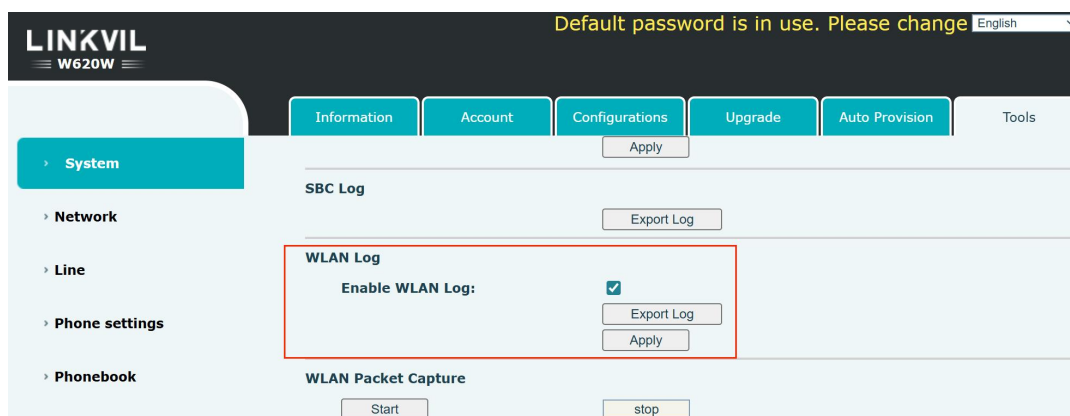

Picture 159 - Get WLAN Log

13.8 Get Bluetooth Data Packet

Bluetooth data packet is helpful when encountering an exception problem. In order to get the bluetooth data packet of the phone, the user can log in the phone web page, open the page [Bluetooth Capture], click the [Start] key, follow the steps of the problem until the problem appears, and then click the [End] key, [Save] to local analysis or send the log to the technician to locate the problem.

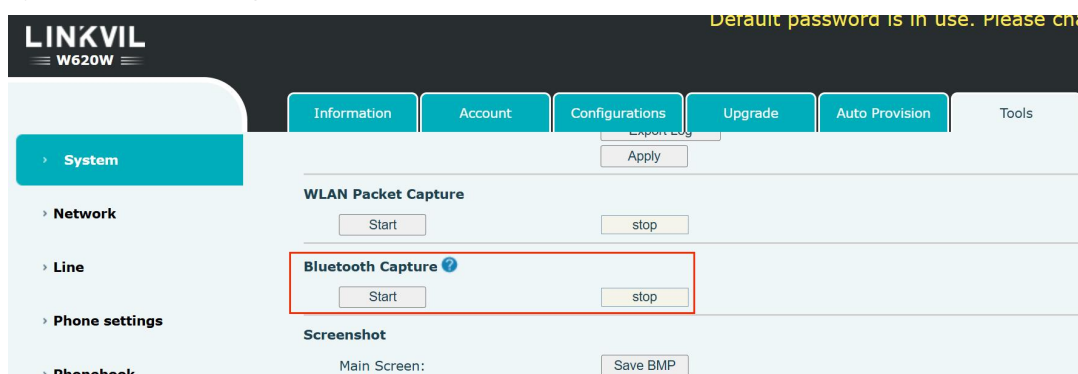

Picture 160 - Get Bluetooth data packet

13.9 One-click Export Debug Info

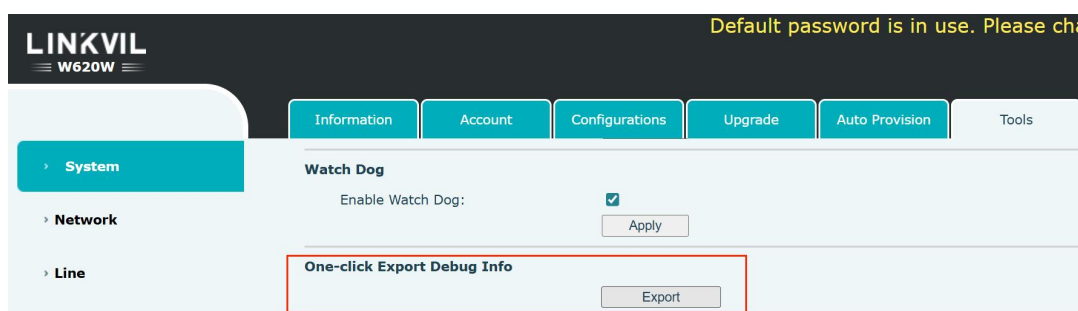

Users can log in to the phone's web interface, open the "One-Click Export of Debug Info" page, and click "Export" to export debugging information with one click.



Picture 161 - One-click export debug info

13.10 Common Trouble Cases

Table 29 - Trouble Cases

Trouble Case	Solution
Device could not boot up	<ol style="list-style-type: none"> 1. First consider the situation that the battery has been exhausted, and charge the device. Please use the charger configured at the time of purchase when charging. 2. If you see the phone enter "POST mode", it means that the phone system is damaged. Please contact technical support to help you restore the phone system.
Device could not register to a service provider	<ol style="list-style-type: none"> 1. Please check whether the phone is connected to the network. The phone needs to be connected to a wireless network, and check whether the wireless icon is normal. If the icon shows  or , the network is unavailable, please check the network facilities. 2. Please check whether the phone has an IP address. Check the system information. If the IP address is Negotiating..., it means that the phone has not obtained an IP address. Please check whether the network configuration is correct. 3. If the network connection is good, please check your line configuration again. If all configurations are correct, please contact your service provider for support, or follow the instructions in "13.6 Network Packets Capture" to obtain a registered network packet and send it to the manufacturer's support mailbox to help analyze the problem.
No Audio or Poor Audio in Handset	<ol style="list-style-type: none"> 1. Please check whether the headset is connected, the headset icon  is displayed in the upper right corner. After connecting the headset, the earpiece channel cannot be used; after unplugging the headset, the earpiece channel can be used. 2. At this point the network bandwidth and latency may not be suitable for audio calls.
Poor Audio or Low Volume in Headset	<ol style="list-style-type: none"> 1. Please use the Headset provided by manufacturer. 2. The network bandwidth and delay may be not suitable for audio call at the moment.
Audio is chopping at far-end in Hands-free speaker mode	<p>This is usually due to loud volume feedback from speaker to microphone. Please lower down the speaker volume a little bit, the phenomenon will be gone.</p>