

Hybrid Inverter User Manual

Three-phase
TriP2-LB-3P 5-20K

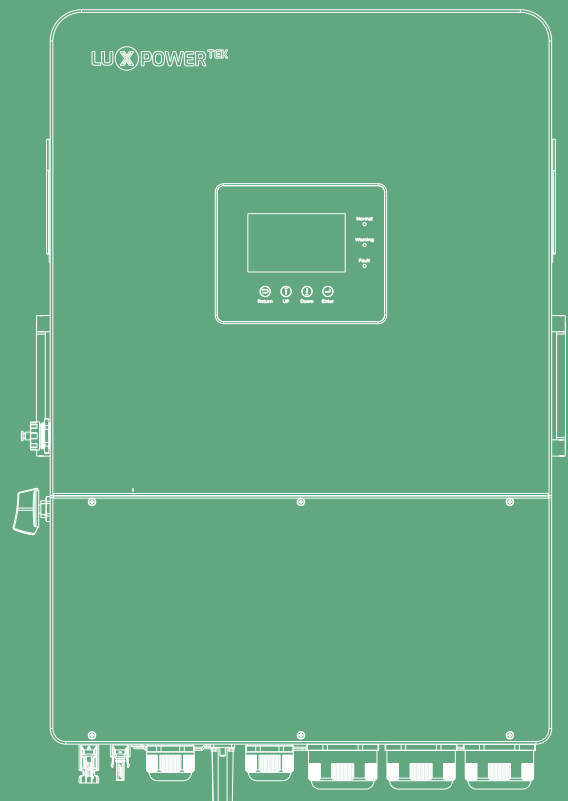

LUX POWER^{TEK}

Copyright© 2025 Lux Power Technology Co., Ltd. All Rights Reserved. This manual, protected by the copyright and intellectual property rights of Lux Power Technology. No part of this document may not be modified, copied, or reproduced without prior written permission.

All brands and trademarks mentioned belong to their respective owners.

Please read carefully carefully to understand product reliability and warranty eligibility. For detailed warranty information, refer to the Lux Power Technology Co., Ltd Warranty. This manual is intended for professional service providers. Nothing in this document constitutes an express or implied warranty.

Descriptions may include forward-looking statements. Actual conditions may differ. This document is provided for reference only and is subject to change without notice by Lux Power Technology Co., Ltd.



Website



YouTube



Facebook

 www.luxpowertek.com



Scan to download

Table Of Contents

Information on this Manual	01
Validity	01
Scope	01
Target Group	01
1. Safety Instruction	01
1.1 Safety Statements	01
1.2 Symbol Conventions	01
1.3 Safety Guidelines	02
1.4 Important Safety Notifications	03
2. Product Introduction	04
2.1 Function Overview	04
2.2 Product Features	05
2.3 Interface of the Inverter	06
2.4 Product Dimensions	08
2.5 Packing List	09
3. Handling and Storage	10
3.1 Handling	10
3.2 Storage	10
4. Installation	11
4.1 Precautions	11
4.2 Selecting Installation Location	12
4.3 Space Requirements	12
4.4 Installation Angle Requirements	13
4.5 Installation Tool	13
4.6 Installing the Inverter	14
5. Electrical Connection	15
5.1 Precautions	15
5.2 Electrical System Connection Diagram	15
5.3 Preparing the Breakers and Cables	16
5.4 Battery Connection	17
5.5 PE Wire Connection	20
5.6 AC Input/Output Connection	21
5.7 PV Connection	24
5.8 CT Connection	26

- 5.9 Meter Connection 29
- 5.10 GEN Port Connection 31
 - 5.10.1 Generator Connection 32
 - 5.10.2 AC Coupling 36
 - 5.10.3 Smart Load 39
- 5.11 Inverter Wiring 41
- 5.12 Installing the Communication Module 44
- 6. Operation Instructions 44**
 - 6.1 Indicator Lights and Button Introduction 44
 - 6.2 Monitoring Connection 45
 - 6.3 LCD Interface Settings Introduction 48
 - 6.4 Operating Mode Settings 50
 - 6.5 Grid Peak-shaving Function 58
- 7. Maintenance 62**
 - 7.1 Startup and Shutdown the Inverter 62
 - 7.2 Regular Maintenance 62
 - 7.3 Firmware Upgrade 63
 - 7.4 Removing the Inverter 64
 - 7.5 Troubleshooting 65
 - 7.6 Replacement of the Fan 70
- 8. Specifications 71**

Revision History

Version	Date	Description
UM-TRIP0203001E	2024.07.15	First official release.
UM-TRIP0203001E01	2025.10.29	Added safety enhancements and resolved known issues.

Information on this Manual

Validity

This manual is valid for the following devices: TriP2-LB-3P 5K/TriP2-LB-3P 6K/TriP2-LB-3P 8K/TriP2-LB-3P 10K/TriP2-LB-3P 12K/TriP2-LB-3P 15K/TriP2-LB-3P 20K.

Scope

This manual provides comprehensive product information and step-by-step installation instructions for the TriP2-LB-3P 5–20K Series Three-Phase Hybrid Energy Storage Inverter (hereinafter referred to as “the inverter”). The product is developed and manufactured by Shenzhen Luxpower Technology Co., Ltd. (hereinafter referred to as “LuxpowerTek”).

Before using this product, please read this manual carefully and keep it in a safe place for future reference.

Target Group

This manual is intended for both professionals and end users. Professionals and end users should possess the following knowledge and skills:

- Understanding of the operating principles of this device.
- Training in installation and electrical safety.
- Experience in installing and commissioning electrical equipment and systems.
- Familiarity with applicable local standards and regulations.

1. Safety Instruction

1.1 Safety Statements





This inverter is designed in compliance with international safety standards. Before installation, operation, or maintenance, please read this manual thoroughly and follow all safety warnings.

Installation and operation must comply with local laws and industry standards. The safety information provided in this manual serves as supplementary guidance and does not replace local regulatory requirements.





Failure to use this equipment under the prescribed conditions may result in personal injury, equipment damage, or property loss. Such incidents are not covered under the warranty.

1.2 Symbol Conventions

The following symbols used in this document have the following meanings:

 DANGER	 WARNING	 CAUTION	 NOTICE
Indicates an extremely hazardous situation. Failure to observe this warning may result in serious injury or death.	Indicates a potentially hazardous situation. Failure to observe this warning may result in serious injury or death.	Indicates a situation that may cause minor or moderate personal injury if proper precautions are not taken.	Indicates a potentially hazardous condition that may result in equipment damage or property loss if ignored.

The symbols present on the nameplate of the HYBRID inverter convey the following meanings:

	Surface Temperature Warning. The inverter may produce heat while in operation. Avoid touching.
	High Voltage Warning. The inverter contains high internal voltage, presenting a life-threatening hazard.
	Electric Shock Warning.
	High Voltage Warning. Before performing any operations, ensure that the residual voltage within the inverter is discharged for a duration of 5 minutes.
	Please adhere to the documents attached.

1.3 Safety Guidelines

1.3.1 PV System

⚠ DANGER

- PV modules generate high DC voltage when exposed to sunlight. Direct contact with the positive and negative terminals simultaneously may cause fatal electric shock.
- Do not ground the PV positive (+) or negative (-) terminal.
- All wiring and testing must be performed by qualified personnel.
- Ensure the PV voltage does not exceed the inverter’s maximum input limit.
- The inverter’s PV ports are equipped with built-in surge protection devices (SPDs). If additional external SPDs are required, they must be installed by qualified professionals.

1.3.2 Inverter

⚠ DANGER

- The inverter contains high-voltage components inside. Do not open the cover without authorization.
- Operation must ensure reliable grounding and be carried out only by qualified personnel.
- Before performing maintenance, turn off the AC and DC circuit breakers in sequence and wait at least 5 minutes before proceeding.

⚠ WARNING

- Do not connect or disconnect AC/DC terminals while the inverter is running.
- The inverter surface may become hot during operation—avoid direct contact.
- Always wear insulated personal protective equipment (PPE) and use insulated tools.
- Ensure battery wiring meets compatibility requirements.
- Do not use LuxpowerTek lithium batteries in lead-acid mode—this will void the warranty.

⚠ CAUTION

- The inverter is heavy; handle it properly and avoid dropping it.

● NOTICE

- If local regulations require an external Residual Current Device (RCD), a 300mA Type-A is recommended. A Type-B device may be used if specifically required by local standards.

1.3.3 Grid Connection

● NOTICE

- If the system is intended for grid-tied generation or power export, all relevant regulations and permits from the local utility company must be strictly followed.
- Grid connection and commissioning must be performed by licensed electricians.

1.4 Important Safety Notifications

Before, during, and after installation, as well as throughout subsequent operation and maintenance, please strictly follow these general safety requirements:

⚠ DANGER High Voltage and High Current Warning

- Ensure both PV and battery systems are turned off before wiring.
- Do not remove the cover or plug/unplug cables while power is applied.
- Before operation, switch off the AC breaker → battery breaker → PV breaker, and verify all indicator lights are off.
- After power-off, wait at least 5 minutes and confirm no residual voltage before servicing.
- Always wear insulated gloves and PPE when handling or operating the inverter.

⚠ CAUTION Prevention of Misoperation

- All operations must be performed by qualified professionals.
- Keep warning and safety labels clearly visible.
- Install the inverter in a location that allows adequate ventilation, easy maintenance, and is out of reach of children.
- During operation, only the LCD display and control buttons may be accessed.

● NOTICE Health Precautions

- Avoid prolonged exposure within 20 cm of the inverter to minimize potential.

2. Product Introduction

2.1 Function Overview

The TriP2-LB-3P 5–20K series is a three-phase hybrid energy storage inverter designed to efficiently manage the energy flow between photovoltaic (PV) and battery storage systems. The inverter stores the DC power generated by PV modules into the battery and can also convert DC power from both PV and the battery into AC power for the following three operation modes:

- Grid-tied Generation: Feed excess energy back into the utility grid.
- Self-consumption: Supply power directly to household or commercial loads.
- Off-grid Operation: Provide independent power to loads during grid outages.

The typical application scenario is illustrated in the diagram below.

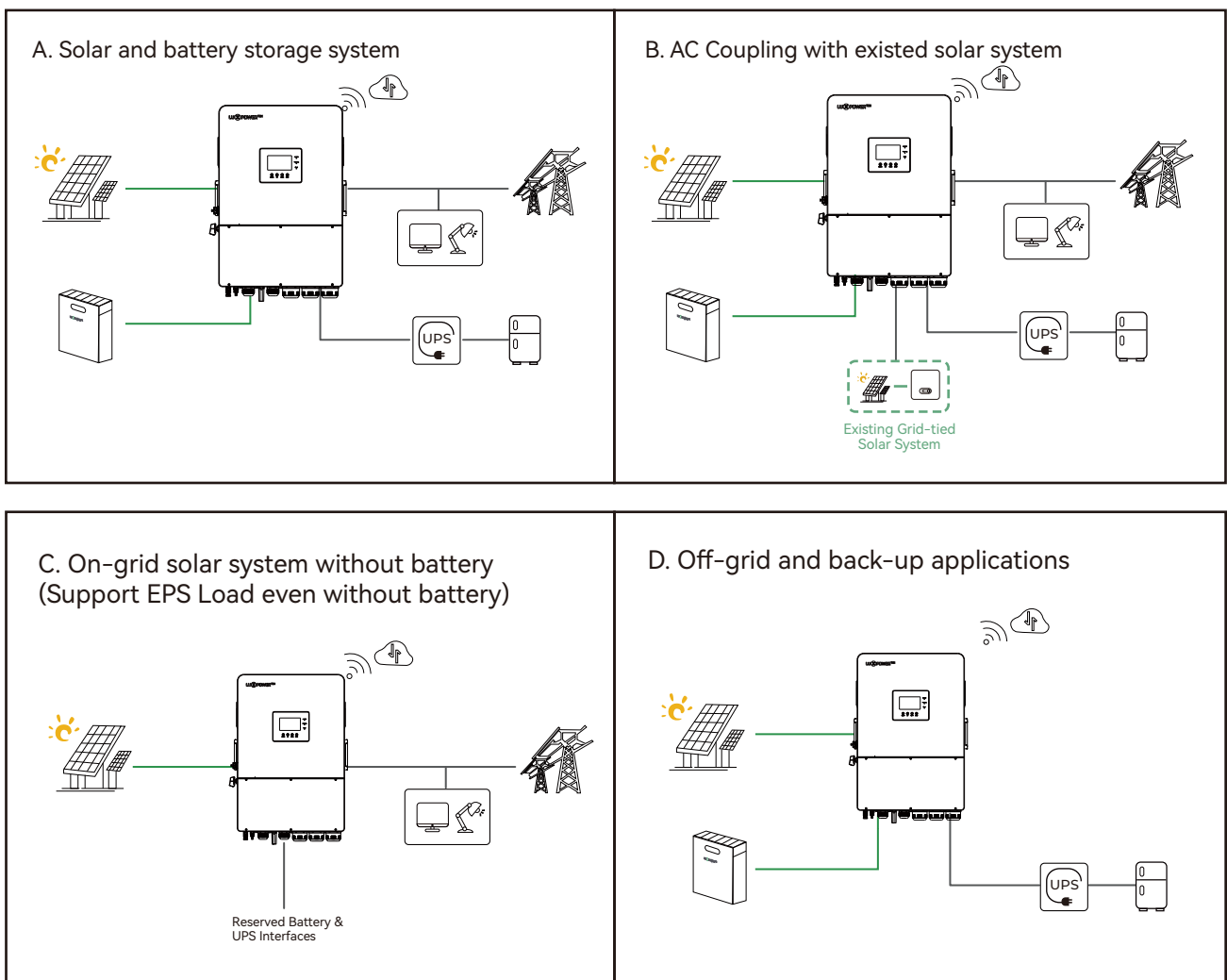

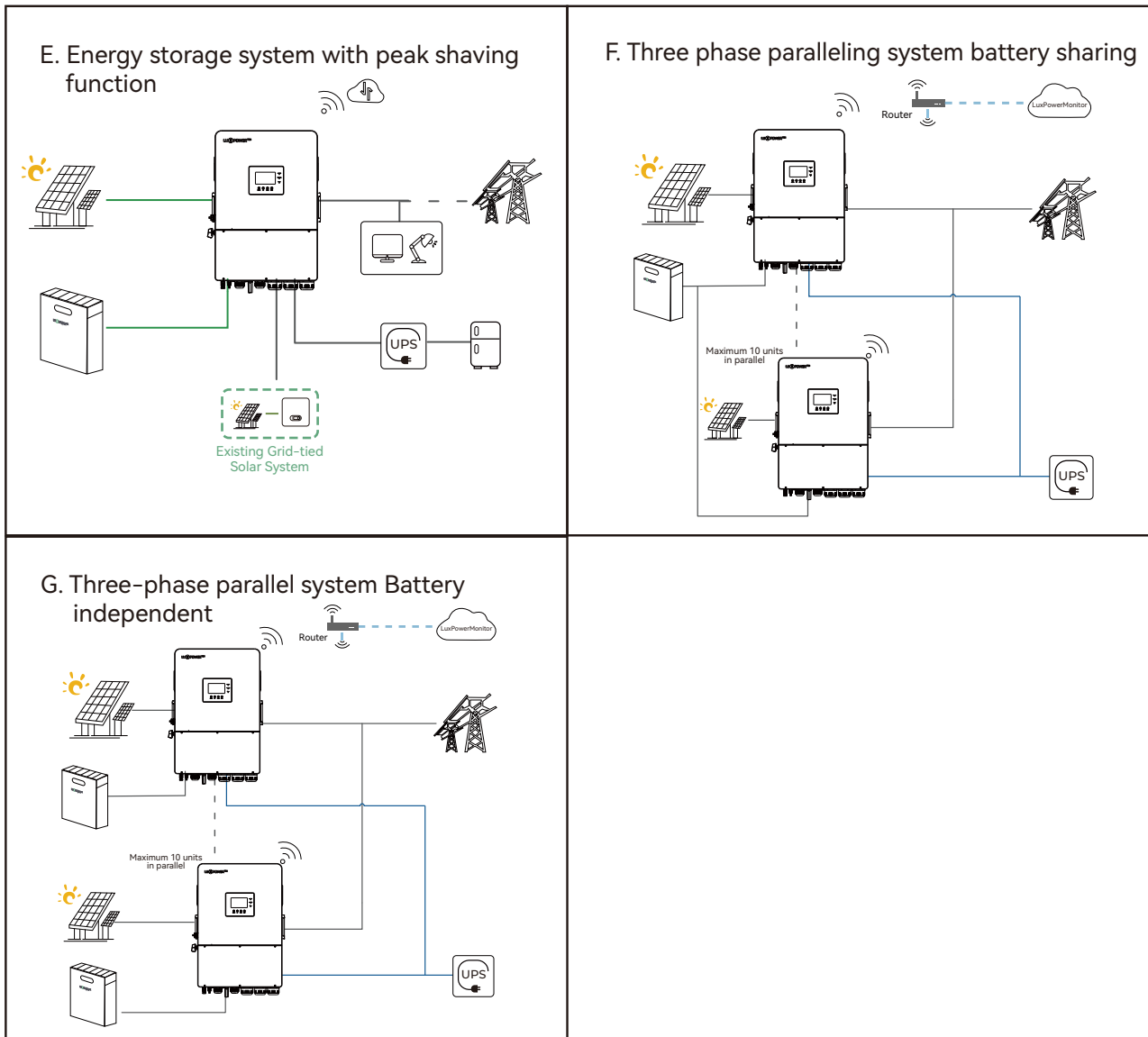

2.2 Product Features

- 230V/400V three-phase pure sine wave inverter
- Self-consumption and grid feed-in capability
- Remote control of power supply priority — battery, grid, or PV priority selectable
- Multiple operation modes — grid-tied, off-grid, and hybrid operation
- Configurable battery charging current and voltage via the LCD display
- Adjustable charging source priority (AC, solar, or generator) through the LCD
- Compatible with both utility grid and generator input
- Comprehensive protection — overload, over-temperature, and short-circuit protection
- Smart battery charger design for optimized battery performance and longevity
- Export power limit function to prevent excess power feed-in to the grid
- Supports WiFi monitoring for remote management
- Built-in 3 MPPT trackers with 3 independent PV input strings
- Intelligent three-stage charging to enhance battery performance
- Time-of-use (TOU) function for flexible energy scheduling
- Smart load management function for optimized energy utilization

2.3 Interface of the Inverter

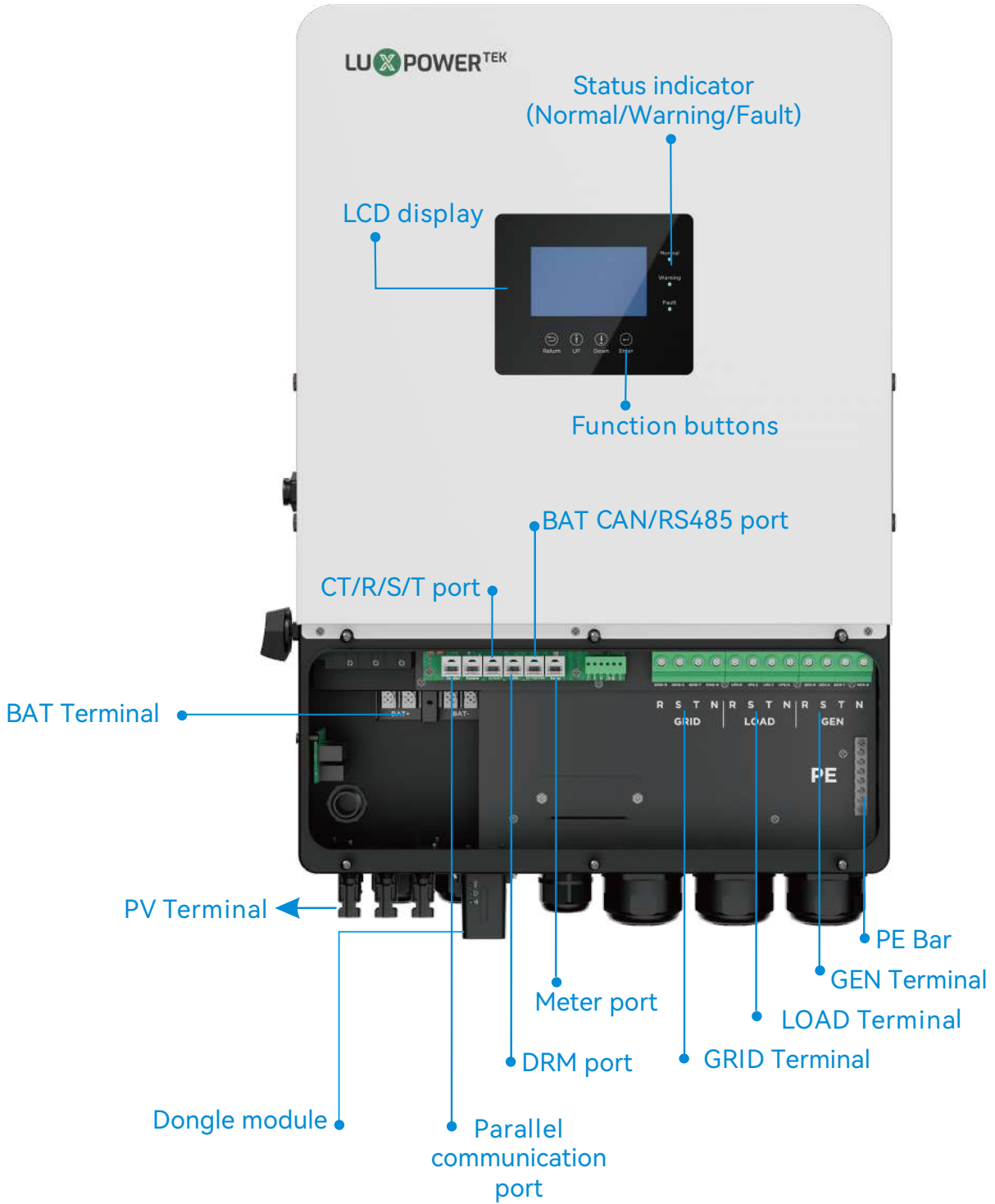

Terminal Introduction

The wiring terminals are located at the bottom of the inverter, please refer to the following diagram:

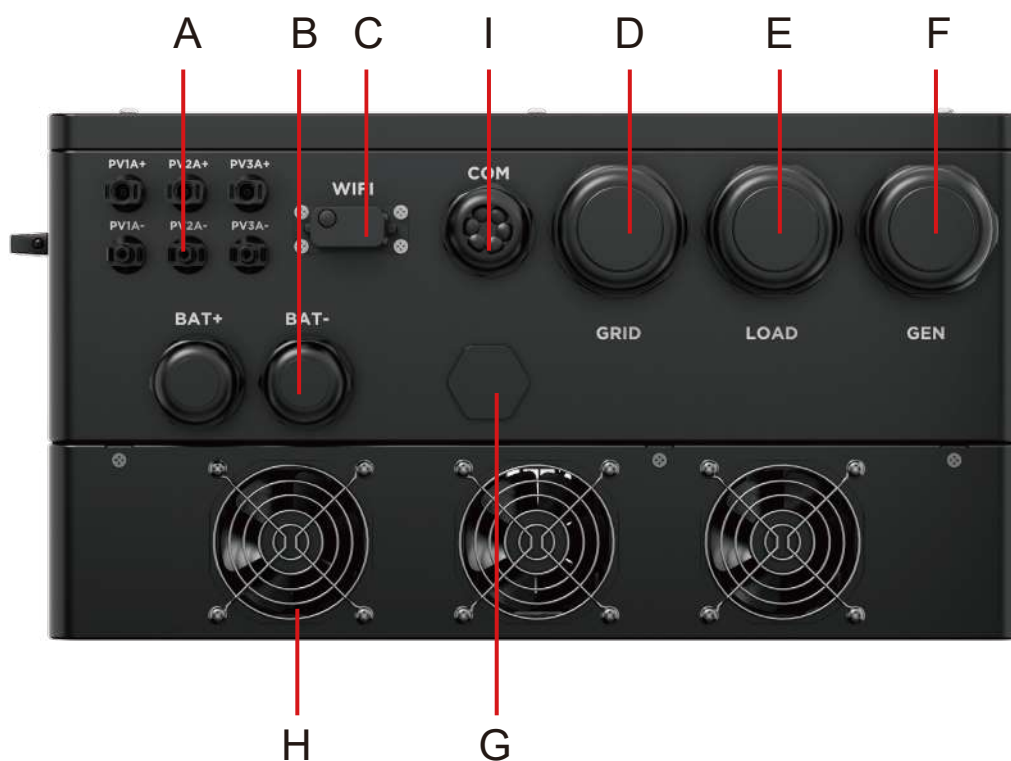

*This diagram is for reference only. Please refer to the actual object for accuracy!

Item	Name	Silk-screen	Remarks
A	PV Input Terminals	PV1+, PV1-, PV2+, PV2-, PV3+, PV3-	MC4 Photovoltaic Connector
B	Battery Connection Ports	BAT1+, BAT1-	Battery Connection Port
C	Monitoring Port	WIFI	For connecting WiFi, GPRS, or 4G modules
D	Grid Output Port	GRID	Installation of power lines for connection to the grid
E	Load output port	LOAD	Installation of UPS Load Output Power Line
F	Generator Wiring port	GEN	Installation of power lines for connection to the generator
G	Waterproof air vent valve	/	/
H	Cooling fan	/	/
I	Communication Wiring Port	COM	Interfaces for connecting battery, meter, parallel operation, etc.

2.4 Product Dimensions

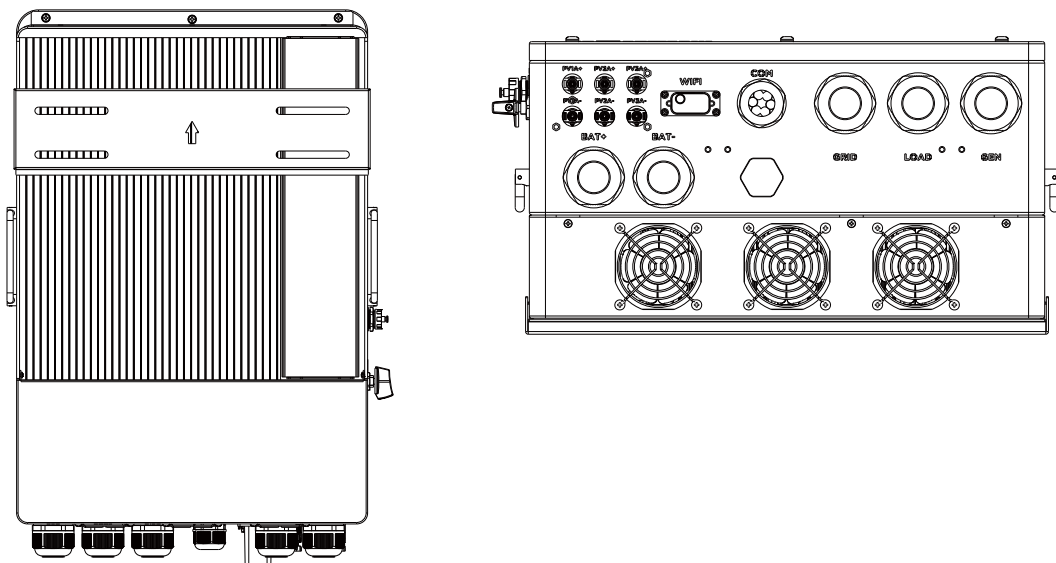
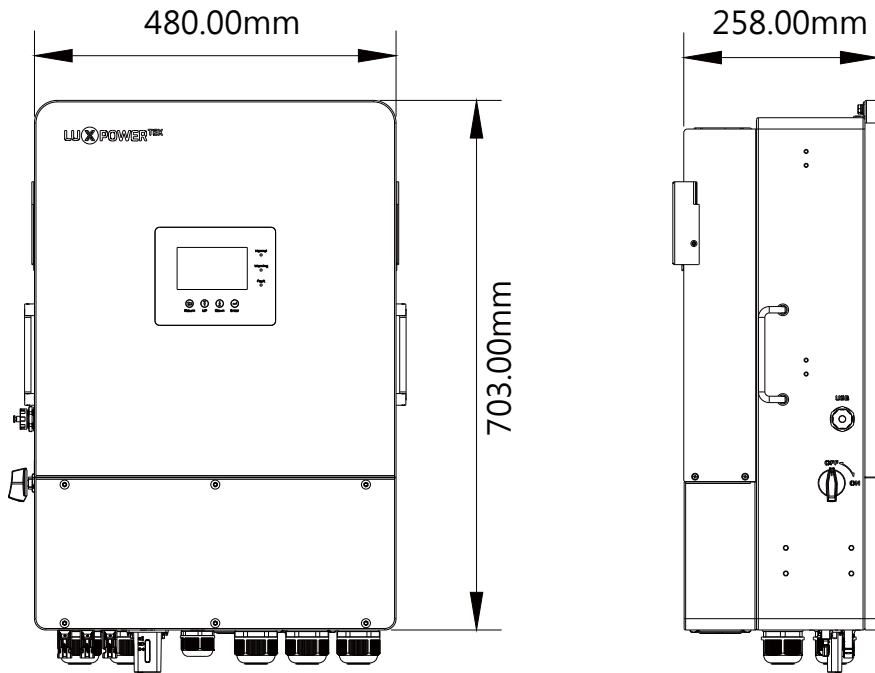

Model	Dimensions (W*H*D)	Weight
TriP2-LB-3P 5/6/8/ 10/12/15/20K	703*480*258mm	53KG

2.5 Packing List

Upon opening the packaging, inspect the inverter for any damage or missing components. In the event of damage or missing parts, kindly get in touch with the manufacturer. The packing list is provided below:

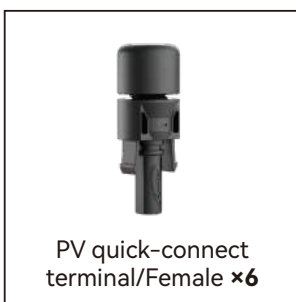
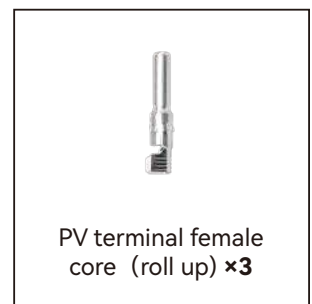
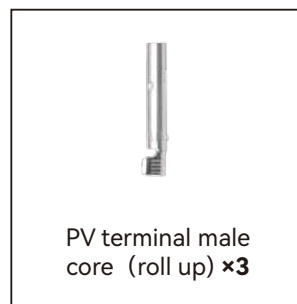
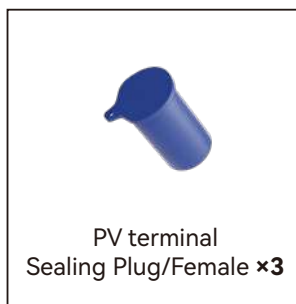
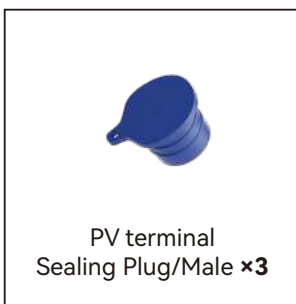
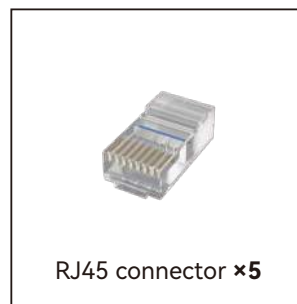
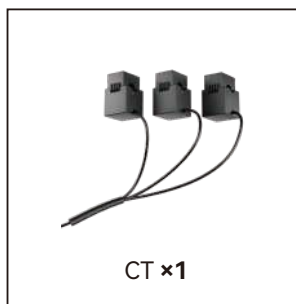
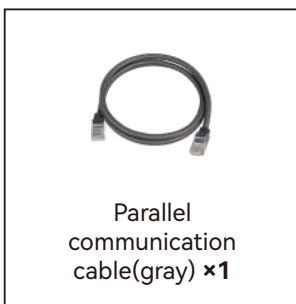
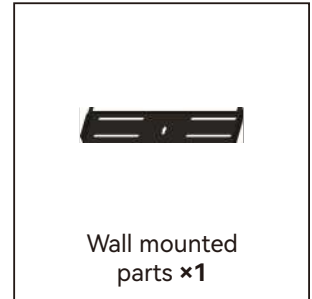
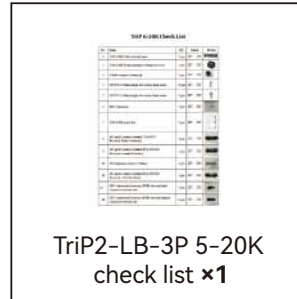
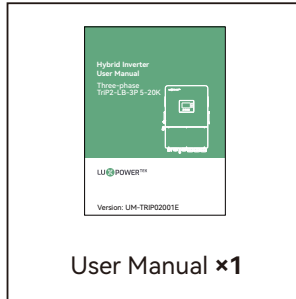

3. Handling and Storage

3.1 Handling

Improper handling may cause personal injury!

- Before handling, carefully check the symbols and markings on the inverter packaging and follow the indicated direction.
- When handling manually, wear protective gloves to avoid injury.
- The inverter is heavy; at least two people are required for manual handling, and the lifting capacity must be confirmed beforehand.
- Move the inverter to its designated installation location before unpacking or installation.
- Do not place the inverter directly on a hard surface, as this may damage its metal casing. Place a protective pad such as foam or sponge underneath.
- Always hold the inverter by its designated handles during transport. Do not lift or carry the inverter by its terminals.

3.2 Storage

If the inverter is not to be used immediately, it should be kept inside its original packaging and stored in a well-ventilated, dry environment.

The recommended storage temperature range is -25°C to $+60^{\circ}\text{C}$, with a relative humidity of 0%–95%.

When stacking multiple inverters, do not exceed the maximum stacking height indicated on the packaging.

The carton must not be tilted or placed upside down.

During long-term storage, it is recommended to inspect the packaging every three months. If any signs of pest or rodent damage, or packaging deterioration, are found, replace the packaging immediately.

Each inverter has undergone comprehensive testing and strict quality inspection before shipment. However, damage may still occur during transportation. Therefore, before signing for the product, carefully check the external packaging for any damage and verify that all equipment and accessories listed in the packing list are complete and undamaged.



4. Installation

4.1 Precautions

- This inverter is designed for wall-mounted installation and must be fixed to a vertical, solid wall capable of supporting its long-term weight, such as a wooden stud wall, brick wall, or concrete wall.
- Due to the inverter's heavy weight, at least two people are recommended for installation.
- The installation location must meet the clearance and dimension requirements of the inverter. Avoid drilling into areas that may contain hidden pipes or electrical wiring inside the wall.
- Do not install the inverter on surfaces made of flammable materials or materials with poor heat resistance.
- The inverter is rated IP66, suitable for both indoor and outdoor installation.
- The mounting location should allow easy access for electrical connections, operation, and maintenance.
- To ensure optimal performance and safety, install the inverter at least 30 meters away from wireless communication devices, residential areas, or strong electromagnetic interference sources.
- The mounting bracket slots are designed to accommodate various hole spacings, suitable for distances between 9 inches (230 mm) and 16.9 inches (430 mm).

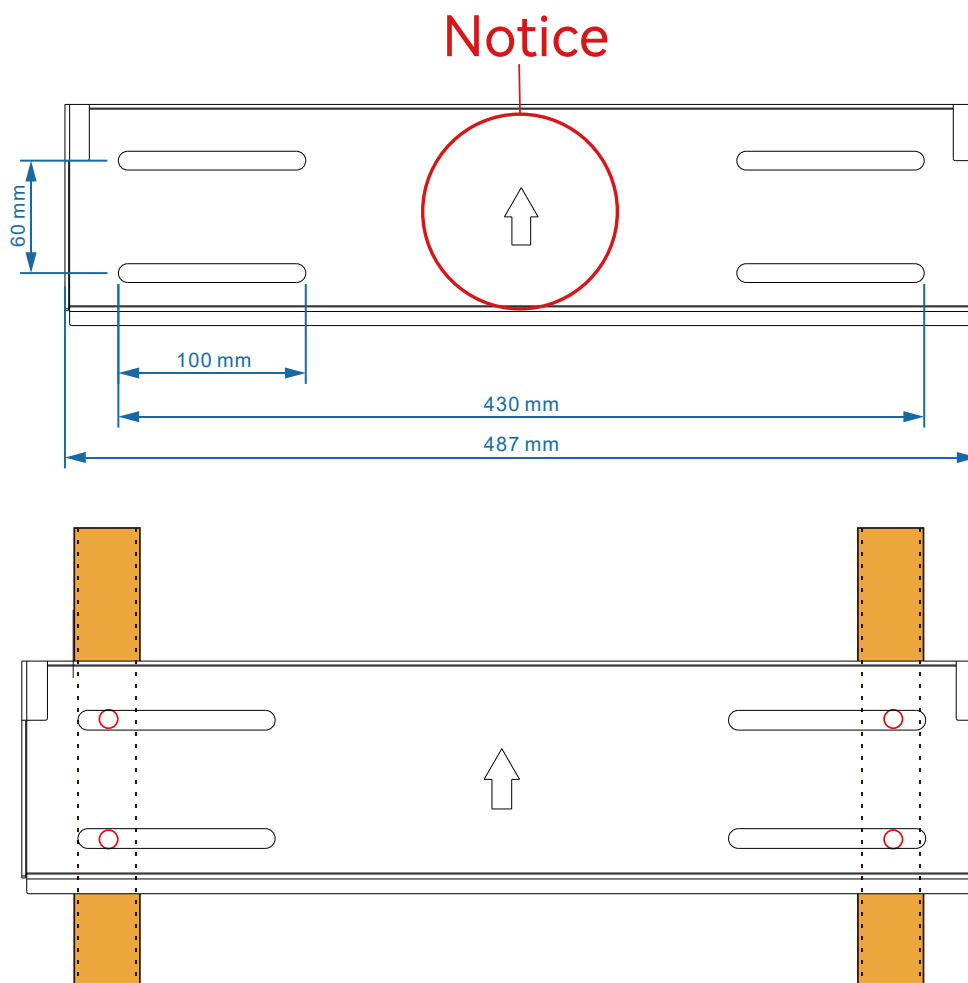

4.2 Selecting Installation Location

⚠ Do not install the inverter in the following environments:

- Under direct sunlight.
- Areas where flammable or explosive materials are stored.
- Potentially explosive atmospheres.
- Locations directly exposed to cold air outlets.
- Near television antennas or antenna cables.
- At altitudes above 2000 m.
- Areas subject to rainfall or humidity greater than 95%.

The inverters are designed for indoor and outdoor installation (IP66), to increase the safety, performance and lifespan of the inverter, please select the mounting location carefully based on the following diagrams:

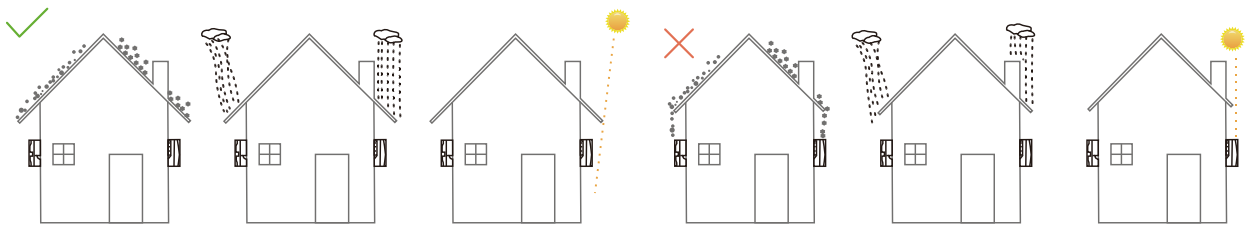

4.3 Space Requirements

To ensure the inverter operates effectively and allows convenient access for personnel, ensure there is ample space around the installation site. Please refer to the diagram below.

Avoid installing the inverter in locations easily accessible to children.

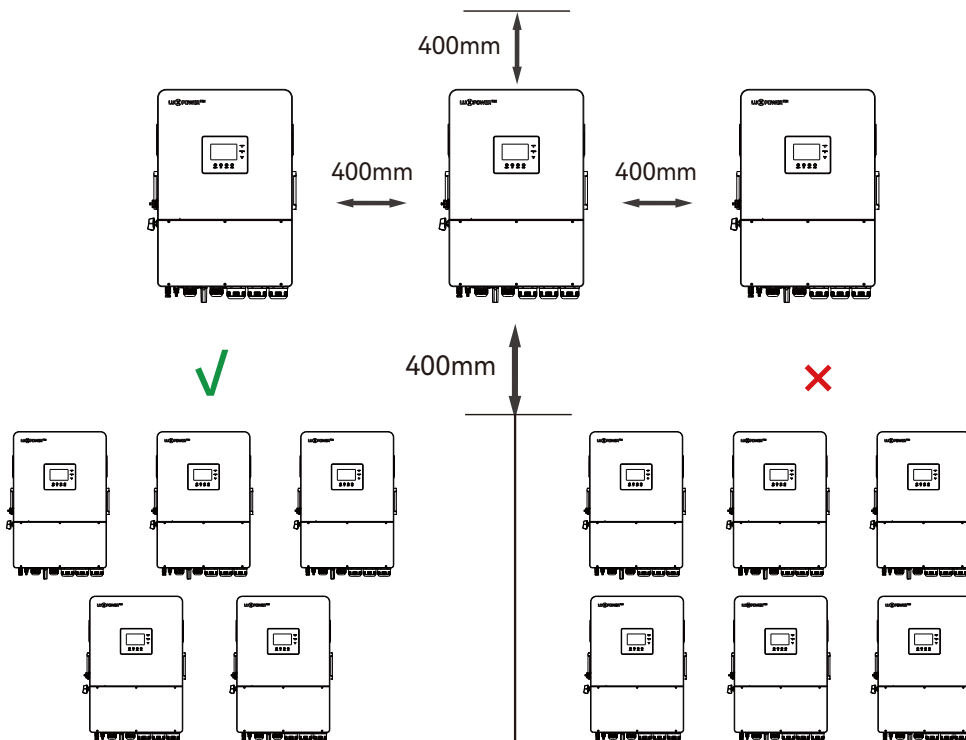





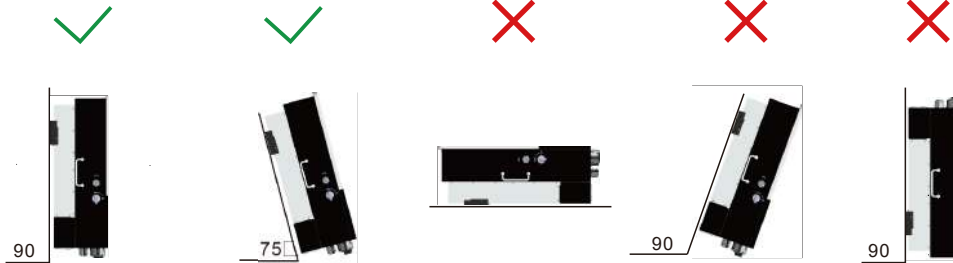















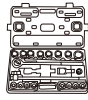

4.4 Installation Angle Requirements

The inverter must be installed in a vertical position. The allowable installation angle range is 90° upright or slightly tilted backward up to 75°. Forward tilting or horizontal placement is strictly prohibited.



4.5 Installation Tools

Recommended tools for installation:

 Protective goggles	 Anti-dust mask	 Earplugs	 Work gloves
 Work shoes	 Utility knife	 Slotted screwdriver	 Cross screwdriver
 Percussion drill	 Pliers	 Marker	 Level
 Rubber hammer	 Socket wrenches set	 Anti-static wrist strap	 Wire cutter
 Wire stripper	 Hydraulic pliers	 Heat gun	 Crimping tool 4-6 mm ²
 Solar connector wrench	 Multimeter ≥1100 VDC	 RJ45 crimping plier	 Cleaner

4.6 Installing the Inverter

Step 1. Select a suitable installation location and ensure the wall surface is flat and solid. Position the wall mount bracket at the designated location, use a level to check alignment, and mark the drilling points on the wall. After drilling, insert expansion bolts and secure the bracket in place.

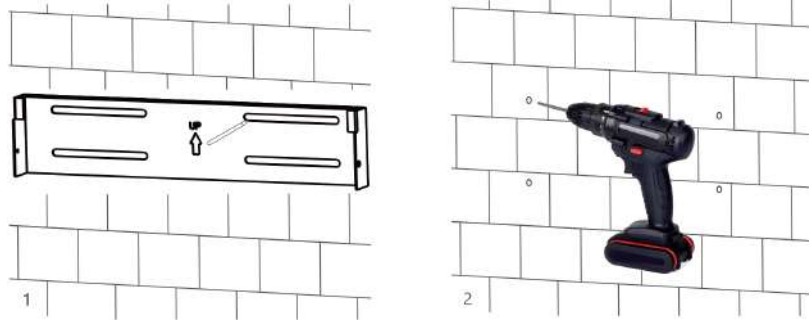

Step 2. Securely fasten the wall bracket to the wall using screws.

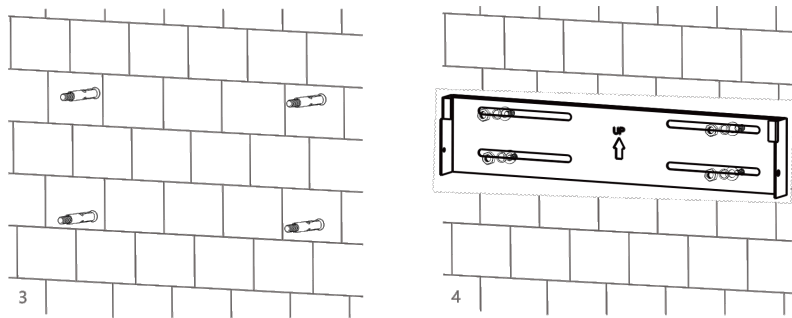

Step 3. Lift the inverter with two people and carefully place it onto the wall bracket.

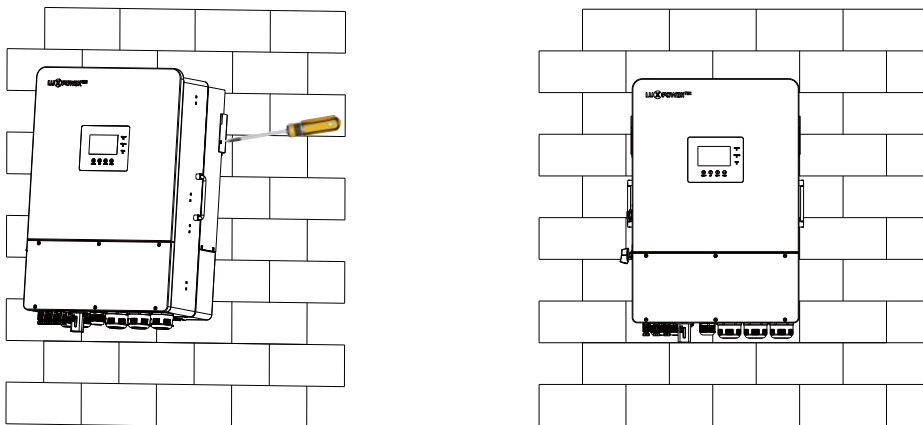

Step 4. Ensure the inverter is securely fixed and tighten all the fastening screws.

5. Electrical Connection

5.1 Precautions

During electrical operations, personnel with expertise must wear appropriate protective equipment.

⚠ DANGER

- Caution: High voltage is present within the inverter!
- Warning: Photovoltaic strings exposed to sunlight can generate hazardous voltages.
- Before completing any electrical connection, make sure the PV Switch, System Switch, and AC Breaker are all disconnected
- Before conducting electrical connections, ensure that all cables are de-energized.

⚠ WARNING

- Improper wiring operations may cause equipment damage or personal injury.
- All wiring operations must be performed independently by qualified technicians.
- Throughout the electrical connection process, use insulated tools and wear PPE.
- Cables used in the PV power system must be securely connected, in good condition, properly insulated, and meet the specified ratings.
- Strictly follow the connection instructions provided in this manual or other relevant documents.
- Any inverter damage caused by incorrect wiring is not covered under warranty.

⚠ CAUTION

- The wiring process must comply with the safety instructions of the PV modules.
- All electrical installations must conform to the national or regional electrical standards of the installation site.

5.2 Electrical System Connection Diagram

5.2.1 System Connection Overview

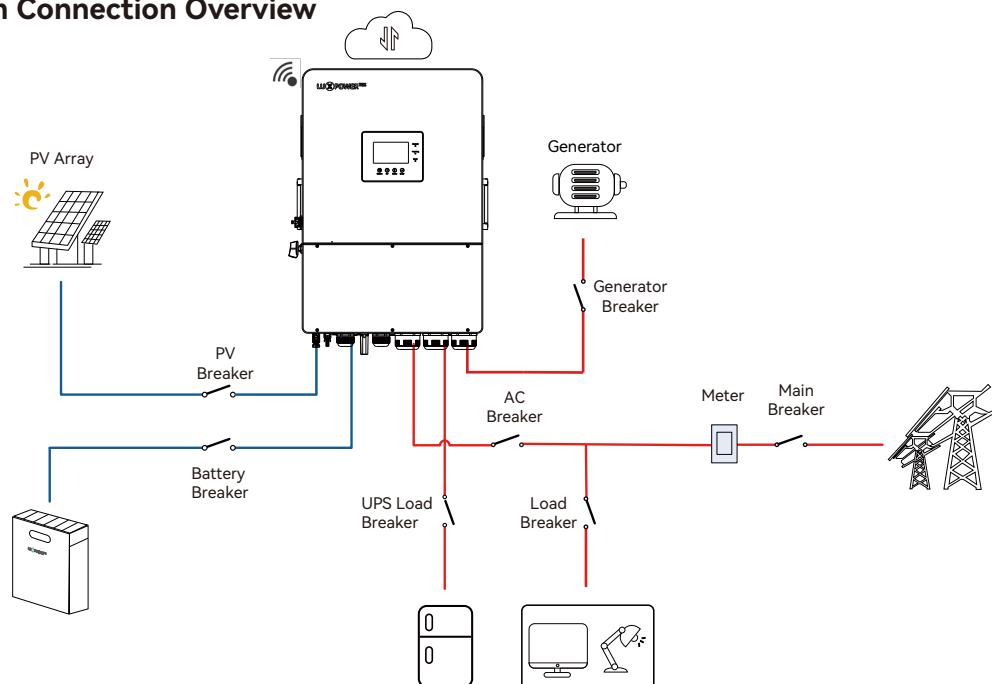

5.2.2 Electrical System Connection Diagram

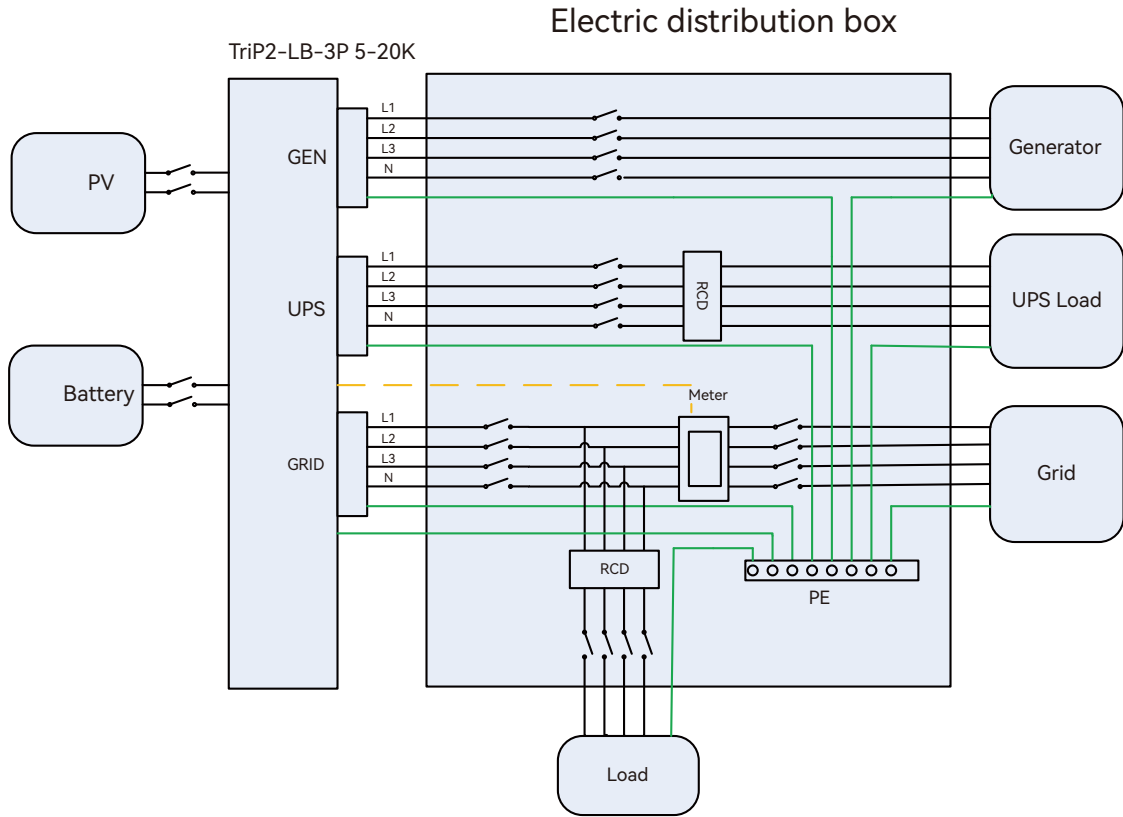

5.3 Preparing the Breakers and Cables

Users should independently prepare corresponding breakers based on the actual application scenario.

PV Breakers(2P*6)	MPPT1 string1: 1000V/20A MPPT2 string1: 1000V/20A MPPT3 string1: 1000V/20A
Battery Breaker(2P)	300A/100V
Main Breaker(4P)	100A/400V
Load Breaker(4P)	63A/400V
AC Load Breaker(4P)	63A/400V
UPS Load Breaker(4P)	63A/400V
Generator Breaker(4P)	63A/400V

Users should independently prepare corresponding cables based on the actual application scenario.

Serial Number	Electrical Name	Type	Conductor Cross-sectional Area	Cable Size
1	Ground cable	Single Core Multi-strand Yellow-Green Wire	Copper Wire (5~9mm ²)	10-8AWG
2	PV Input Wire	Single Core Multi-strand Copper Wire	Copper Wire (5~9mm ²)	10-8AWG
3	AC Output Wire	Single Core Multi-strand Copper Wire	Copper Wire (8~14mm ²)	8-6AWG
4	Battery Power Connection Wire	Single Core Multi-strand Copper Wire	Copper Wire (67-85mm ²)	2/0-3/0AWG
5	Battery Communication Wire	CAT-5 Ethernet Cable(RJ45) Outdoor Shielded Twisted Pair Wire	Multi-strand Copper Wire	/
6	Wireless Monitoring	WiFi/GPRS/4G	/	/

5.4 Battery Connection

This section of the manual only describes the battery connection on the inverter side. If you need more detailed information regarding the battery connection on the battery side, please refer to the battery manual.

● NOTICE

- All wiring work must be carried out by qualified personnel.
- Before wiring, make sure the inverter is powered off and that no residual voltage remains at the battery terminals.
- If the battery cables are already connected on the battery side, ensure that the battery is turned off before proceeding.
- When the battery is in high current charge/discharge operation, the terminal screws must be tightly secured to ensure reliable connection.
- If a switch is installed between the inverter and the battery, confirm that it is in the OFF position before connection.
- Because large currents may flow between the inverter and the battery, it is recommended to keep the distance between them as short as possible.
- Always ensure correct polarity. Do not reverse the battery cable connections, as this may cause severe inverter damage.
- Use appropriate battery cables and ensure that the connectors match the battery terminals properly.
- Install a dedicated DC circuit breaker between the inverter and the battery. The recommended rating is 300V / 100A.

5.4.1 Cable Requirements

Inverter Model	Cable Conductor Cross-Sectional Area	Cable Model	Cable Voltage Endurance Requirements	Compatible Cable Hole
5K/6K/8K10K/ 12K/15K/20K	67-85mm ²	3/0-2/0AWG	600V	M6/M8

If the terminals of the battery power cables do not match the inverter’s battery connection ports, please reconfigure the wiring according to the following steps.

Wiring Procedures:

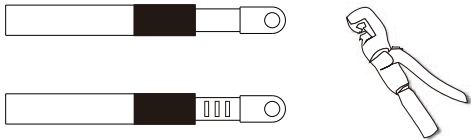
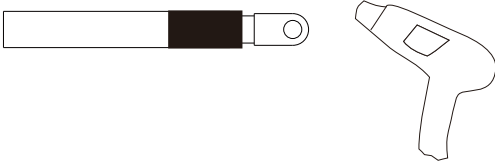
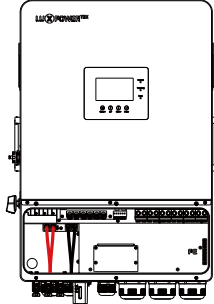
<p>1. Remove the insulation layer from the cable and install the cold-pressed terminal.</p> 	<p>2. Utilize a crimping tool to crimp the terminal, ensuring that the cable is securely fastened and cannot be pulled out after crimping.</p> 
<p>3. Use a heat gun to fix the heat shrink tube</p> 	<p>4. Confirm that the battery is in the closed state, then insert the battery connector into the corresponding terminal of the inverter’s battery input wiring area.</p> 

5.4.2 Battery Communication Cable Connection

NOTICE

- The battery typically includes an Ethernet cable, so it is recommended to use the provided Ethernet cable for the connection.
- If you need to replace the Ethernet cable, please choose a CAT5 or higher specification cable with a 568B wiring standard.

The communication interface of the battery is depicted in the diagram below.

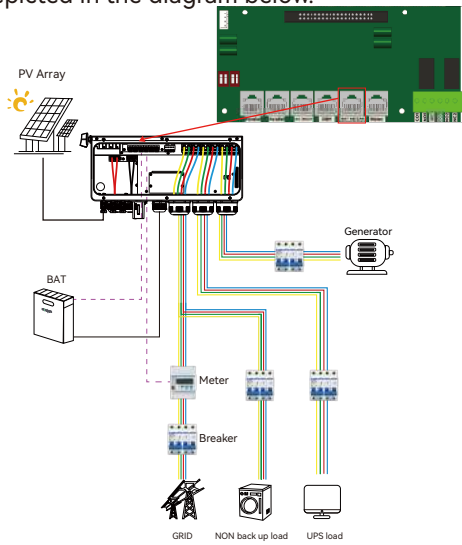

The configuration of the communication interface for the battery is as follows:



PIN	Function Description
1	BAT.485B
2	BAT.485A
3	NC
4	CAN-H
5	CAN-L
6	NC
7	NC
8	GND

Wiring Procedures:

Step 1: Loosen the COM gland nut on the inverter casing, and remove the sealing plug from the cable gland as required. Do not remove the sealing plug from any unused cable entry ports.

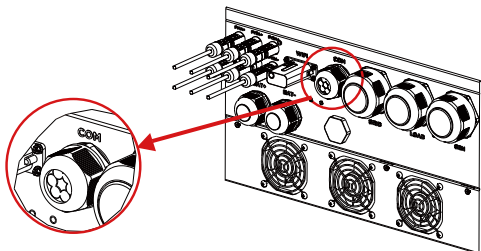

Step 2: Pass the battery communication cable sequentially through the gland nut, cable gland, and connector housing.

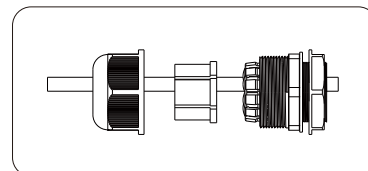

Step 3: Insert the RJ45 connector into the inverter's internal BAT 485/CAN port. Finally, tighten the gland nut to ensure a firm and sealed connection.

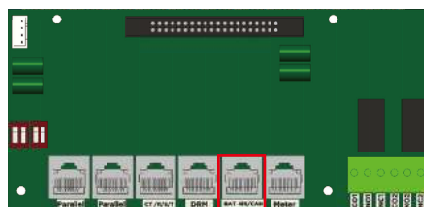

5.5 PE Wire Connecton

To ensure electrical safety and reliable system grounding, the inverter chassis grounding must be completed before any other wiring operations.



⚠ WARNING

- All wiring work must be carried out by qualified personnel.
- This inverter is a transformerless type. When operating in a grid-connected system without an isolation transformer, the PV string positive (+) and negative (-) terminals must not be grounded (PE) to ensure proper system operation.
- Before connecting the PV strings, battery, grid, or communication devices, ensure that the protective grounding (PE) connection is properly established.
- In a photovoltaic system, all non-current-carrying metal parts and equipment enclosures must be grounded.
- The inverter’s PE grounding wire and the metal frame of the PV array must be connected to the same grounding point to achieve equipotential bonding.
- Ensure that all grounding terminal connections are properly sealed against moisture and not directly exposed to air.
- When tightening the grounding screw on the inverter casing, the recommended torque is 5 N·m.

Cable Requirements:

Electrical Name	Type	Conductor Cross-Sectional Area	Cable Size
PE cable	Single core multi-strand yellow-green wire	Copper Wire (5~9mm ²)	10-8AWG

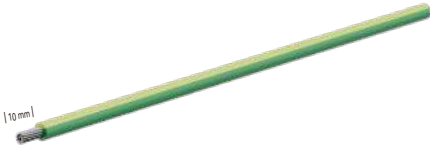
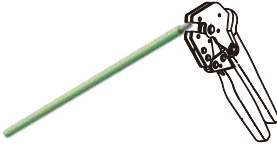
Wiring Procedures:

<p>Step 1: Prepare the grounding wire: Use a 10-8 AWG (5-9 mm²) copper grounding wire and strip approximately 10 mm of insulation.</p> 	<p>Step 2: Crimp the wire end: Use a crimping tool to ensure the wire strands are tightly compacted — no loose or frayed strands.</p> 
<p>Step 3: Connect to the grounding terminal: Insert the crimped end into the PE aluminum grounding bar inside the inverter wiring box and fasten it securely with screws to ensure a solid, reliable connection.</p> 	<p>Step 4: Verify grounding integrity: Confirm that the grounding wire is firmly secured to the grounding bar and properly connected to the grounding network.</p> 

⚠ WARNING

- Improper grounding may cause electric shock hazards or equipment malfunction.
- Always comply with local electrical codes and standards.

● NOTICE

- When multiple inverters are connected in parallel, all chassis grounding wires must be connected to a common grounding point to prevent potential differences between devices.
- Each AC interface (e.g., Grid, Load, Gen) must have an independent PE grounding wire connected to the grounding bar.
- Sharing a single PE wire among multiple AC interfaces is strictly prohibited, as it may cause fault current backflow or excessive grounding impedance.
- The chassis grounding wire is for protective grounding only and must not replace the PE wire of the AC output.
- If local regulations require equipotential bonding, use a dedicated grounding busbar to interconnect the PV mounting frame, inverter casing, and other metallic components.

5.6 AC Input/Output Connection

⚠ WARNING

The AC Output Port must not be connected to any type of transformer !

- Connecting a transformer may cause internal circuit malfunction, overload, or damage, posing a potential safety hazard.
- Only household appliances or loads within the rated output range may be connected.
- For extended applications, strictly follow the official installation guide and consult technical support.

● NOTICE

- For final installation, breakers certified to IEC 60947-1 and IEC 60947-2 standards must be used. All wiring operations must be performed by qualified personnel.
- To ensure system safety and reliable operation, use AC input cables of appropriate specifications. Before wiring, make sure that the AC power supply is completely disconnected.
- The inverter has three clearly labeled terminals: “Grid”, “Load”, and “GEN”. Do not mix up input and output terminals.
- The protective grounding cable should be long enough to ensure that, in the event of accidental pulling of the AC output cable, the grounding wire bears the final mechanical stress.

Cable Requirements:

Cable Conductor Cross-Sectional Area	Cable Model	Cable Voltage Endurance Requirements
Copper Wire (8-14mm ²)	8-6AWG	600V

Wire Color:

L (Live)→R: Yellow

S: Green

T: Red

N (Neutral)→Black

5.6.1 Grid Port Connection

Wiring Procedures

Step 1: Before wiring, make sure that all AC breakers or isolators are turned off.

Step 2: Strip approximately 10 mm of insulation from each conductor.



Step 3: Crimp the stripped ends firmly using an appropriate crimping tool.



Step 4: Loosen the terminal bolts and insert the crimped L and N wires into the corresponding Grid terminals according to the polarity labels. Ensure that the R, S, T, N phase sequence is correct and not reversed.



Step 5: Tighten the terminal screws to the recommended torque (12 N·m).

Step 6: Verify that all wires are securely fastened and cannot loosen.

Step 7: Ensure that all wires are properly positioned and securely fixed within the Grid ports.



NOTICE

Input Side (Grid): The AC input side must be connected to the utility grid through a circuit breaker.

5.6.2 Load Port Connection

Wiring Procedures

Step 1: Before wiring, make sure that all AC breakers or isolators are turned off.

Step 2: Strip approximately 10 mm of insulation from each conductor.



Step 3: Crimp the stripped ends using a wire crimping tool.



Step 4: Loosen the terminal bolts and insert the crimped L and N wires into the corresponding Load terminals according to the polarity labels. Ensure that the R, S, T, N phase sequence is correct and not reversed.



Step 5: Tighten the terminal screws to the recommended torque (12 N·m).

Step 6: Ensure all connections are firmly secured to prevent loosening.



● NOTICE

The Load port (AC output) is designed for household loads (EPS/Backup output). Properly distribute load power to ensure grounding safety and system stability.

5.7 PV Connection

⚠ CAUTION

- Before connecting the PV modules, ensure that both the PV switch and the AC circuit breaker are turned off, and that the PV module output is properly isolated from the ground.
- When using PV modules, ensure that the PV+ and PV- terminals are not connected to the system grounding bar.
- Before making the connection, verify that the polarity of the PV array output voltage matches the inverter’s “DC+” and “DC-” terminals.
- Before connecting the inverter, make sure the open-circuit voltage (Voc) of the PV array does not exceed 800V, the inverter’s maximum input voltage limit.
- To reduce the risk of fire, always use dedicated photovoltaic crimping tools to ensure all connections are firm and reliable.
- This system may be powered by multiple energy sources and may contain several live circuits—operate with extreme caution.
- Use only UV-resistant, double-insulated solar cables that comply with outdoor photovoltaic application standards.
- A separate DC circuit breaker must be installed between the PV modules and the inverter. The recommended rating is 1000V / 20A.

● NOTICE

Before connecting the photovoltaic panels, use a multimeter to measure the voltage of the photovoltaic array to confirm proper functioning. If the voltage is not within the expected range, ensure that the photovoltaic array is in normal working condition before making the connection.

In cases where the ambient temperature of your photovoltaic panels may be below 0°C, check the voltage of the photovoltaic array. If you are unsure, seek further assistance from your system or panel supplier. Extremely low temperatures may cause the voltage of the photovoltaic panels to increase by a certain percentage.

- Connect each string of photovoltaic panels separately to the TriP2-LB-3P 5-20K inverter and strictly avoid combining
- all photovoltaic strings before individually connecting them to each input of the TriP2-LB-3P 5-20K inverter
- Each MPPT tracker of the TriP2-LB-3P 5-20K inverter can accommodate two photovoltaic strings.
- Plug waterproof plugs into the unused PV input terminals.

Pay attention to distinguishing between PV terminal cores and battery terminal cores (refer to the diagram below).



PV male connector

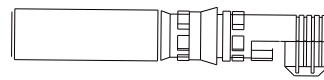

PV female connector

Cable Requirements:

Inverter Model	Cable Conductor Cross-Sectional Area	Cable Model	Cable Voltage Endurance Requirements
5K/6K/8K	5 mm ²	10 AWG	1000V
10K/12K/15K/20K	9 mm ²	8 AWG	1000V

1. Remove the insulation layer from the cable and install the cold-pressed terminal.

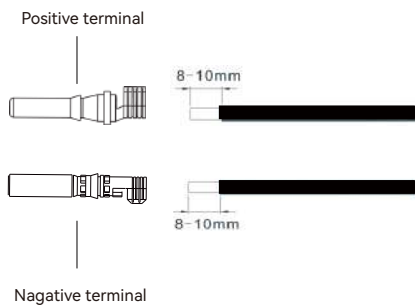

2. Utilize a crimping tool to crimp the terminal ensuring that the cable cannot be pulled out after crimping.

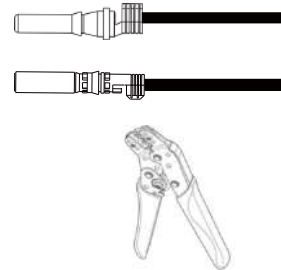

3. Securely assemble the cable into the positive and negative terminal shells.

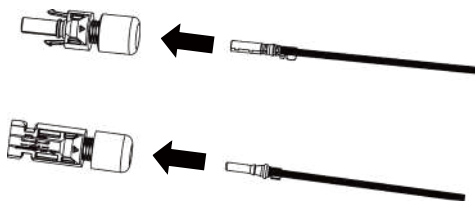

4. Tighten the sealing nut.

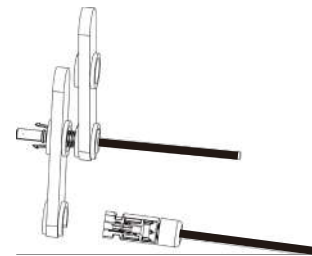

5. Check the polarity of the photovoltaic string cable and ensure that the highest voltage does not exceed 1000V.

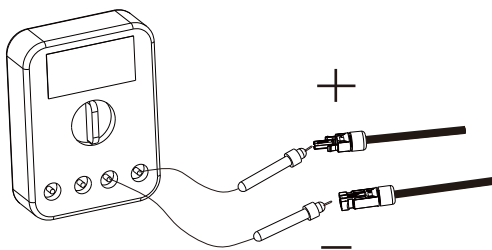

6. Confirm that all DC switches are in the "OFF" position, then insert the PV connector into the corresponding PV terminal in the inverter's PV input wiring area.

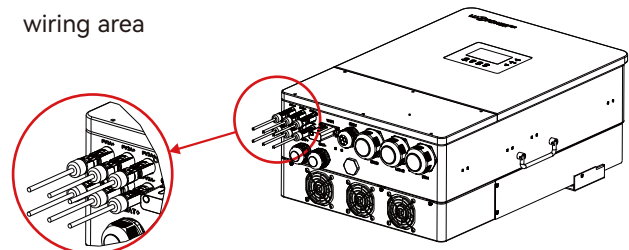

WARNING

When sunlight hits the PV modules, they generate voltage. Multiple modules connected in series can produce high DC voltage, creating a risk of electric shock. Therefore, before connecting the DC input cables, cover the PV modules with an opaque material and ensure that the DC switch is in the "OFF" position. Failure to follow this instruction may result in high voltage at the inverter terminals, posing a serious and potentially life-threatening hazard.

5.8 CT Connection

⚠ WARNING

- Before connecting any AC cables or current transformers (CTs), ensure that all AC cables are completely isolated from the AC power supply to avoid the risk of electric shock.
- Do not install the CT on the neutral (N) or protective earth (PE) conductor.
- Do not install the CT around both the live (L) and neutral (N) wires simultaneously.
- The installation direction of the CT must be correct — the arrow on the CT must point toward the inverter.
- Do not install the CT on uninsulated conductors.
- The CT signal cable included in the accessory pack is 3 meters. If the installation distance is longer, it is recommended to use an external energy meter for power measurement to ensure data stability and accuracy.
- After completing the wiring, use insulating tape or cable ties to secure the CT clamp and cable to prevent loosening or disconnection.

5.8.1 Overview

The CT (Current Transformer) is used to measure the grid-connected input and output power. It must be installed at the main incoming switch or near the main distribution box.

By default, the external grid CT function is disabled. If energy feedback to the grid is required, it can be enabled via LCD → Advanced Settings → External Grid CT.

Incorrect CT installation may result in inaccurate power measurement values, which can affect the inverter’s performance and displayed data

5.8.2 Port Definition



PIN	Function Description
1	IR+
2	IR-
3	IS+
4	IS-
5	IT+
6	IT-
7	NC
8	NC

5.8.3 CT Connection

CAUTION

- The CT arrow must face toward the inverter.
- If the installation direction is incorrect, you can adjust it via LCD → Advanced Settings → CT Direction Reverse, without changing the physical wiring.
- Ensure that the CT clamp is securely fastened around the cable.

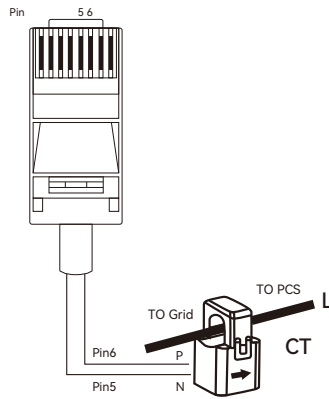

The connection and configuration methods are as follows:

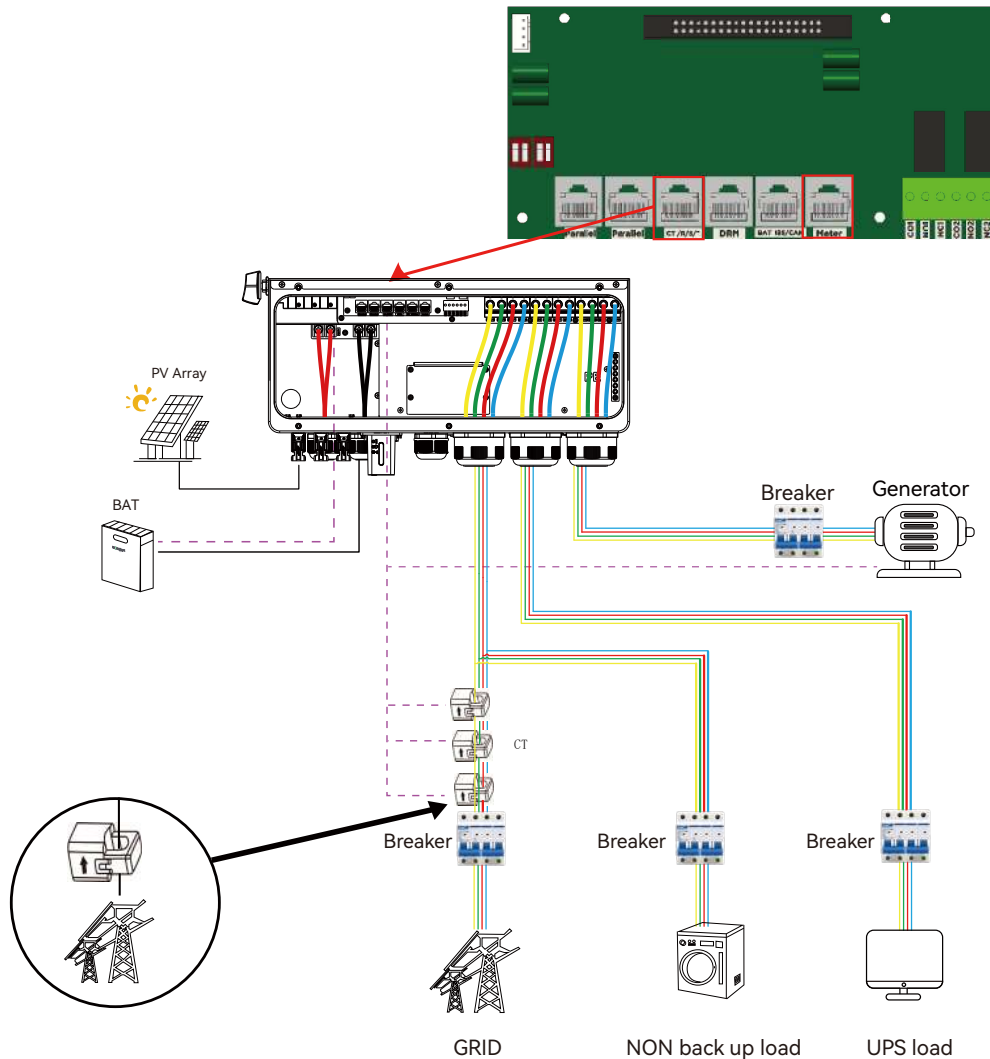

LCD setting is as follows:

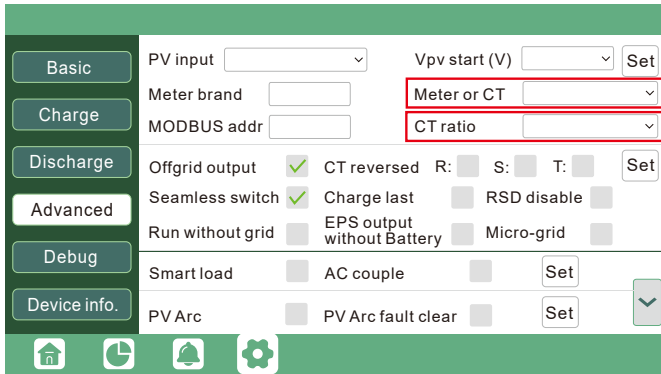

CT ratio

- Supported: 1000:1, 2000:1, 3000:1.
- Default ratio: 1000:1.
- Third-party CT: support one of the above and configure it correctly in the LCD menu or monitoring platform.

When the cable length is insufficient:

Operating Procedures:

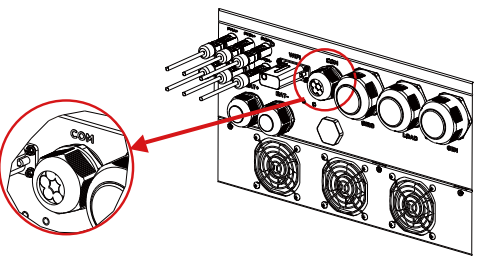
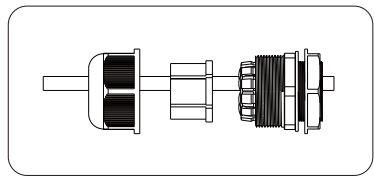
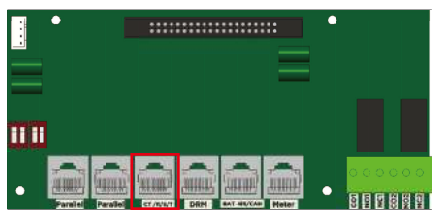
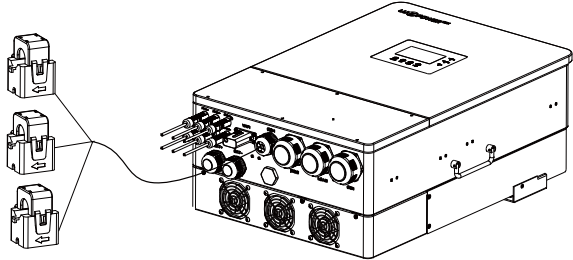
<p>Step 1: Loosen the locking nut on the COM port, then remove the sealing plug from the cable gland as needed. Do not remove unused sealing plugs if no cable connection is required.</p> 	<p>Step 2: Crimp RJ45 connectors onto both ends of the prepared network cable. Pass the cable through the locking nut, cable gland, and connector housing in sequence.</p> 
<p>Step 3: Insert the cable into the internal port of the inverter until a “click” sound is heard, indicating a secure connection. Then, tighten the locking nut.</p> 	<p>Step 4: Insert the RJ45 connector of the network cable and the RJ45 connector of the CT together into the RJ45 coupler.</p> 

5.9 Meter Connection

⚠ CAUTION

- When the inverter is operating in off-grid mode, the neutral (N) line must be grounded.
- If the energy meter is equipped with a grounding terminal, ensure that it is properly connected to PE ground.
- Only use manufacturer-authorized or certified energy meters. Using unauthorized meters may result in incompatibility with the inverter, causing equipment damage or abnormal operation.
- The manufacturer assumes no responsibility for any consequences arising from the use of unauthorized third-party devices.

● NOTICE

- The inverter provides a reserved meter access interface, which can be connected to TriP2-LB-3P 5-20K via RS485 for obtaining power information from the grid side.
- For meter connection, please use a straight-through CAT5 cable with 568B wiring standard to connect the inverter and the meter.
- Communication between the inverter and the meter is achieved through RS485. Connect pin 1 of the RJ485 port in the diagram to the 485-B of the meter, and pin 2 to the 485-A of the meter.
- If using a meter included with the device, no additional configuration is necessary. It comes with default settings and will operate normally once the communication cable is connected.
- If using a separately purchased meter, take note of the model. Currently, the device supports only two recommended models mentioned below. When connecting, set the corresponding model on the LCD. The meter baud rate is 9600, and the meter address is 01. For detailed settings, refer to the meter's instruction manual.

5.9.1 Port Definition

The configuration of the meter communication interface is as follows:



PIN	Function Description
1	Meter B
2	Meter A
3	NC
4	NC
5	NC
6	NC
7	NC
8	NC

5.9.2 Communication interface Diagram

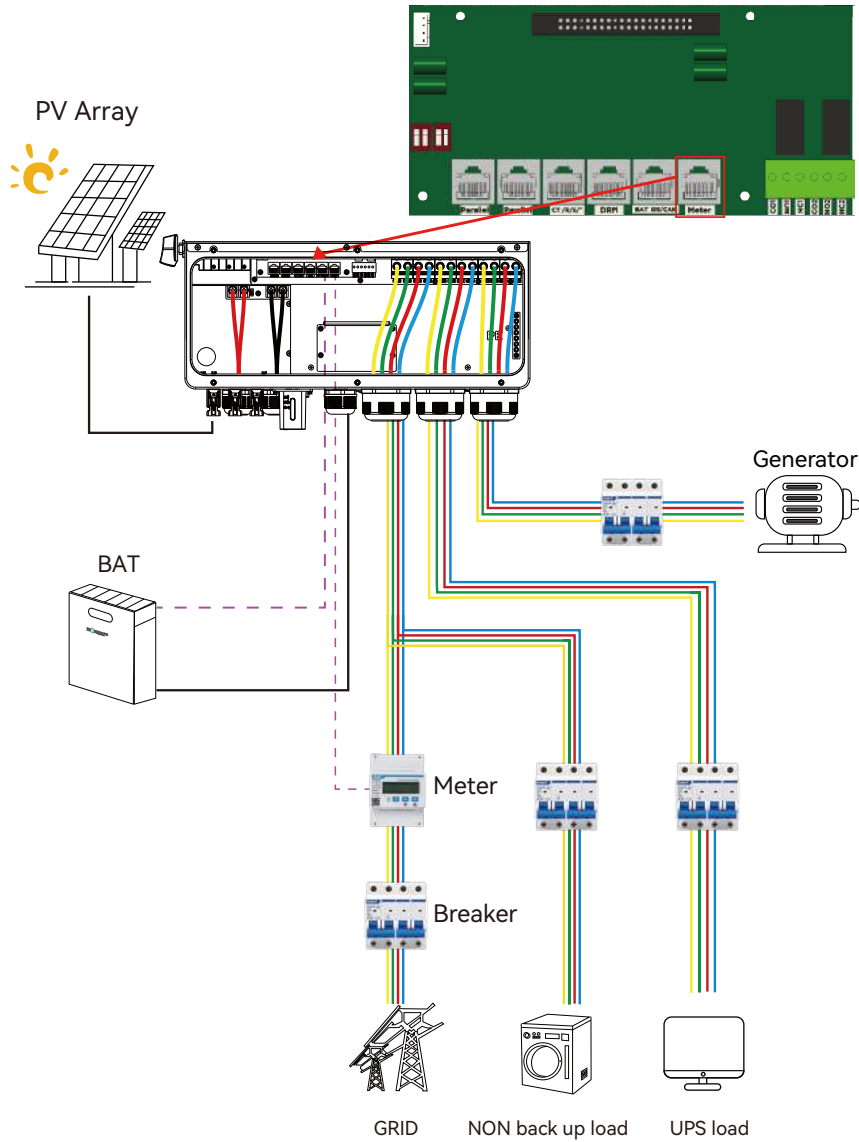

Choose the meter brand on the LCD.

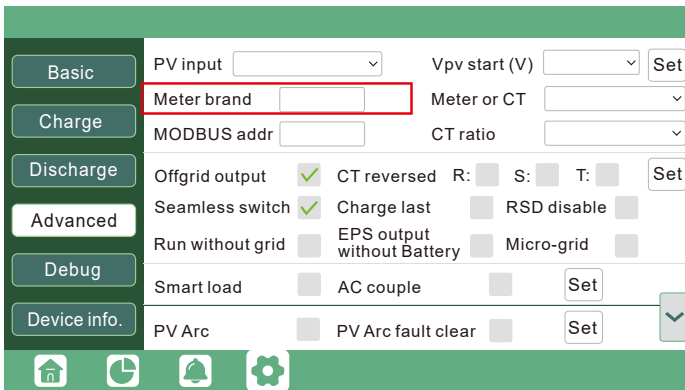

Recommended meter:

Brand	Model
CHINT	DTSU666
EASTRON	SDM630-Modbus V2

The connection direction for the meter is as shown in the diagram below: the input side of the meter connects to the grid, while the output side connects to the inverter and load. For definitions of the input and output terminals of the meter, please refer to the meter's instruction manual.

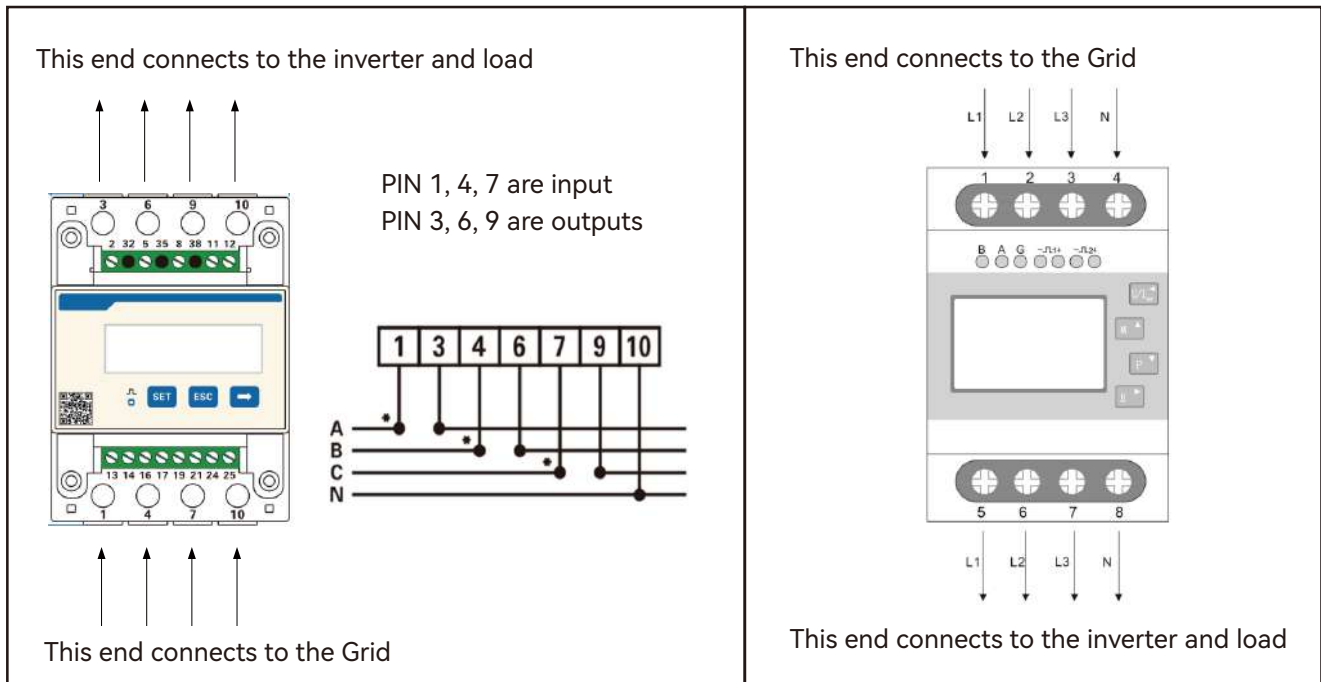

5.10 GEN Port Connection

NOTICE

1. The GEN port is a multifunctional interface that can be configured for one of the following three application modes:

- a. Generator Connection
- b. Smart Load
- c. AC Coupling

These three functions are mutually exclusive. Only one function can be selected for actual use; they cannot be used simultaneously.

2. The generator must be connected to the GEN port through a dedicated circuit breaker to ensure safe operation. It is recommended to use a circuit breaker compliant with IEC 60947-1 / IEC 60947-2 standards, with a typical rating of 63V/400A. The breaker size may be adjusted according to the rated power of the generator.

5.10.1 Generator Connection

5.10.1.1 Function Overview

This product supports generator connection through the GEN port for both battery charging and household load supply. In the event of a grid outage, the generator can serve as a backup power source to ensure continuous system operation.

- When selecting a generator, ensure sufficient capacity and stable frequency (Total Harmonic Distortion THD < 3%).
- It is recommended that the generator’s rated output power be at least 1.5 times the inverter output power to meet both load supply and battery charging requirements.
- The table below lists the recommended generator capacities corresponding to the number of parallel inverters:

Number of inverters in parallel	Generator Capacity
1	>10kW
2	>15kW
3	>20kW
4	25kW

5.10.1.2 Wiring Instruction

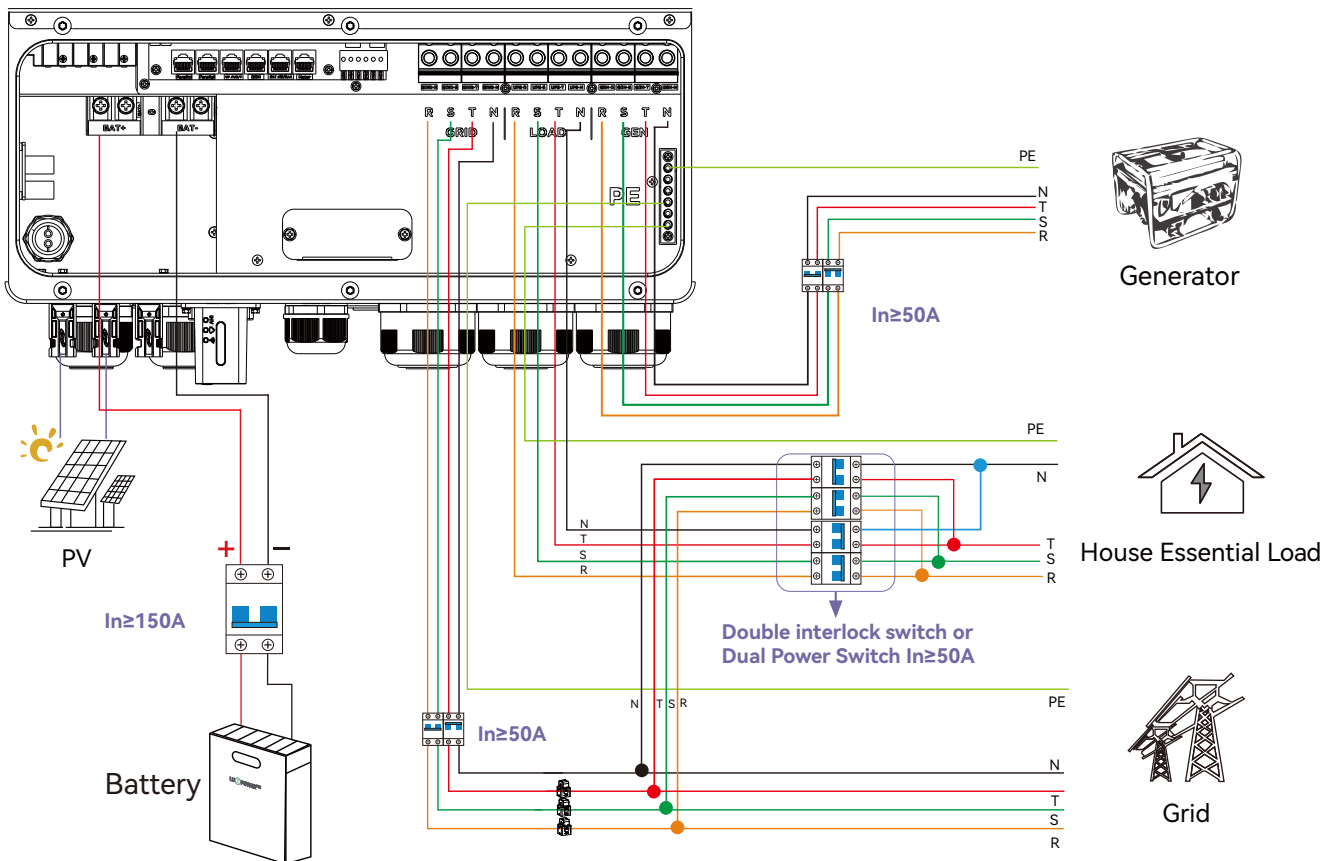

Wiring Procedures:

Step 1: Ensure that both the inverter and the generator are powered off, and that all circuit breakers are in the OFF position.

Step 2: Correctly identify the generator output terminals:

- a. R (Live line): Yellow
- b. S (Live line): Green
- c. T (Live line): Red
- d. N (Neutral line): Black
- e. PE (Ground line): Yellow-green

Step 3: Connect the generator’s ground line (PE) to the inverter’s grounding terminal.

Step 4: Connect the R/S/T lines to the corresponding GEN terminals on the inverter, and connect the N line to the N terminal of the GEN port.

5.10.1.3 Generator Auto Start/Stop Logic

When the generator wiring is completed and the generator supports remote start functionality, the inverter can automatically control the generator’s start and stop operations based on the battery status, enabling intelligent charging and seamless power switching.



Operating Logic:

- When the battery voltage or SOC (State of Charge) drops below the preset threshold, or when a charge request is received from the BMS, the inverter will automatically start the generator.
- Once the generator starts, the system will prioritize charging the battery, while any surplus power will automatically supply the connected loads.
- When the battery voltage or SOC reaches the preset upper limit, the inverter will automatically shut down the generator

5.10.1.4 Two-Wire Start/Stop Control

The inverter is equipped with a dry contact interface (NO1/COM1) that can send start and stop signals to an external generator to enable automatic start/stop control.

The generator’s control circuit will automatically open or close based on the inverter’s operating status and the battery’s state of charge — no manual intervention is required.

Unit Status	Condition		 Dry port NO2 COM2	 GEN NO1 COM1
			NO2 & COM2	NO1 & COM1
Power Off	Inverter is off and no output is powered.		Open	Open
Power On	Without Grid	Battery voltage < Low DC warning voltage	Close	Close
		Battery voltage > Setting value or battery charging reaches floating stage	Open	Open
	With Grid	Battery voltage < Low DC warning voltage	Close	Open
		Battery voltage > Setting value or battery charging reaches floating stage	Open	Open

NO: Normal open

Dry Port Relay Maximum Specification: 250VAC 5A

Gen Port Relay Maximum Specification: 250VAC 5A

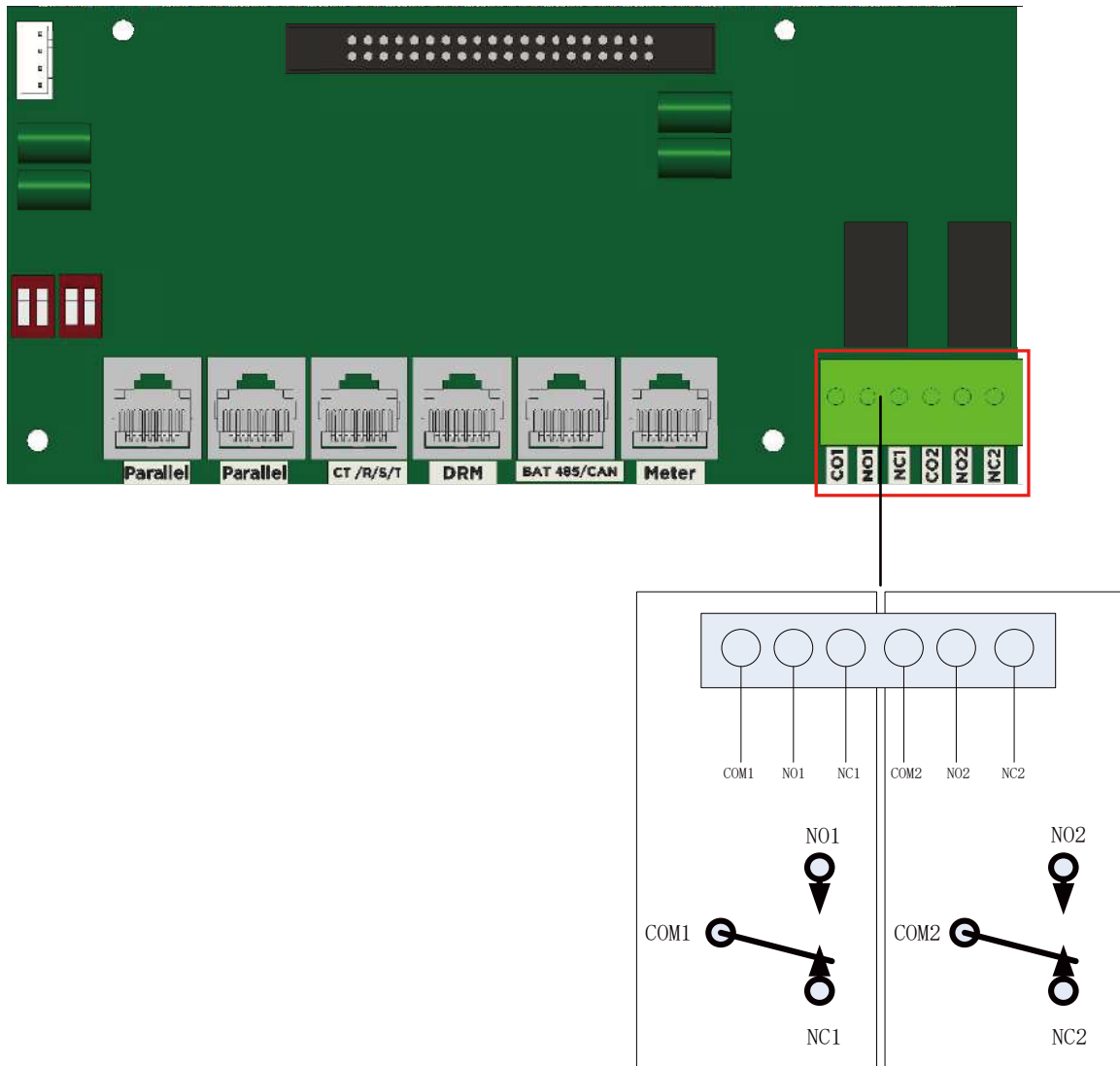

5.10.1.5 Working with a Generator

- This inverter is designed to work seamlessly with a generator. It comes equipped with a generator port specifically designed for connecting a three-phase generator with an input voltage of 230/400V.
- Upon the generator's activation, the device will automatically disconnect from the grid, directing all loads connected to the EPS (Emergency Power System) to be powered by the generator. Simultaneously, the battery will undergo a charging cycle.
- For users who wish to initiate the generator remotely using this device, it's essential to connect the generator start signal to the COM port of the device. Refer to the diagram for specific connection details; it can be linked to COM1 and NO1 of a normally open switch or COM1 and NC1 of a normally closed switch.
- The system intelligently uses the battery's State of Charge (SOC) or battery voltage to determine whether it's necessary to remotely start or stop the generator.

Note: The straight-through relay on the generator port has a rating of 60A. When starting the generator, it's crucial to ensure that the total load and charging current do not exceed 60A.

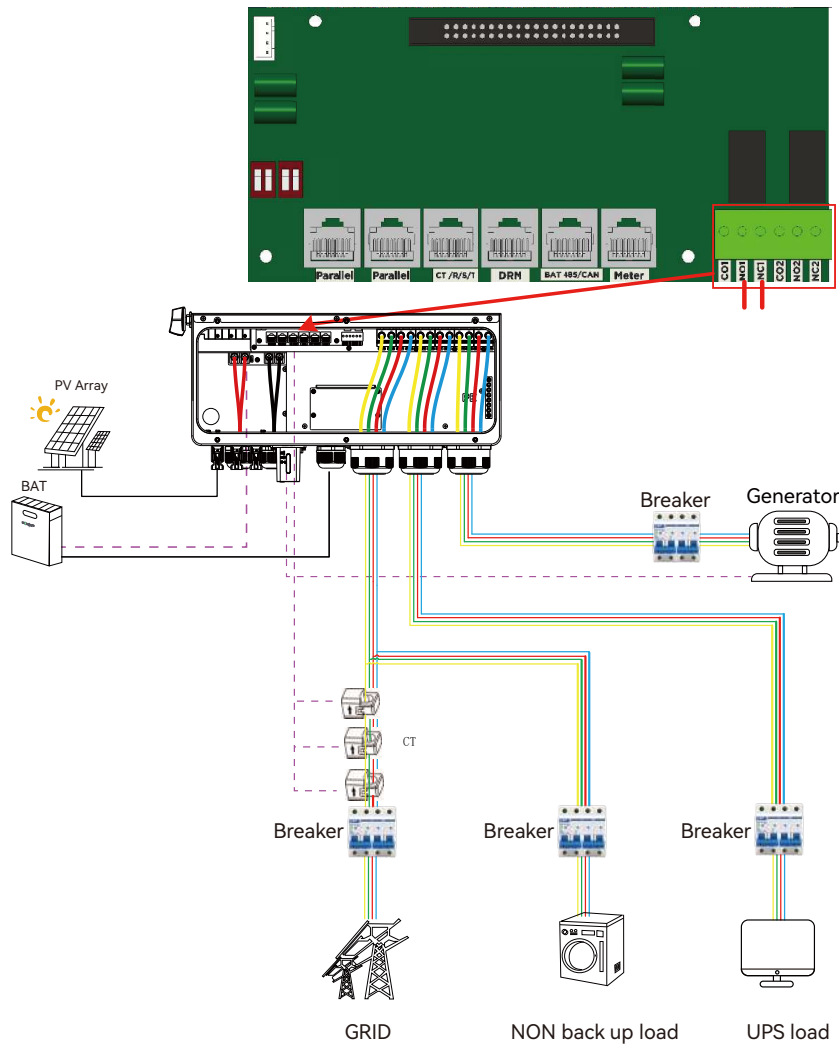

Charging Mode Settings:

Users can select the generator charging logic via the Luxpower monitoring platform or the LCD interface:

By Voltage: The generator starts and stops based on the battery voltage (recommended for lead-acid batteries).

By SOC (State of Charge): The generator starts and stops based on the battery’s state of charge (recommended for lithium batteries).

Recommendation:

Select “By SOC” mode for lithium batteries, and “By Voltage” mode for lead-acid batteries.

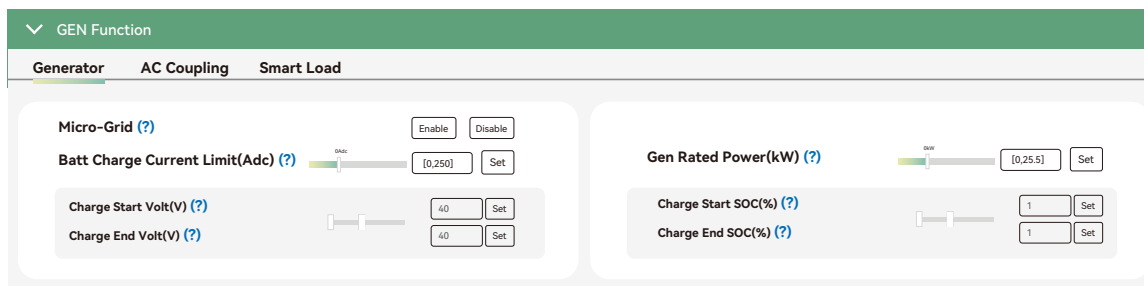

5.10.1.6 Gen Boost function

The GEN Boost function is used when the generator power is insufficient to supply the entire load. In this case, the PV system and battery jointly provide supplementary power to ensure stable operation. When enabled, the system reserves a certain power margin for the generator to avoid frequent fluctuations that could cause overload, thereby extending generator lifespan and improving reliability.

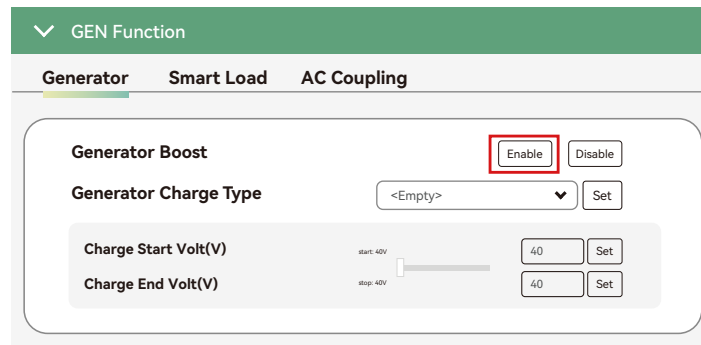

5.10.2 AC Coupling

5.10.2.1 Function Overview

The AC Coupling function allows users to integrate an existing on-grid inverter system through the GEN interface, thereby upgrading the system into a hybrid energy storage system.

- When the utility grid is disconnected, this inverter automatically switches to off-grid mode, maintaining stable system voltage and frequency, and enables the on-grid inverter to continue generating power via the GEN interface.
 - When PV power is sufficient, the inverter prioritizes load supply and uses surplus energy to charge the battery.
 - Once the battery is fully charged, the inverter will limit the output power of the on-grid inverter.
 - When PV power is insufficient, both the battery and the on-grid inverter will supply power jointly to ensure uninterrupted operation of critical loads.

When the utility grid is available, this inverter and the on-grid inverter operate in coordination. Solar energy can simultaneously power loads and charge the battery. When load demand is low or the battery is fully charged, excess energy can be exported to the grid, ensuring optimal energy utilization.

NOTICE

When using the AC Coupling function while the grid is available, ensure that the system has proper grid connection authorization and fully complies with local grid interconnection regulations.

5.10.2.2 Wiring Instruction

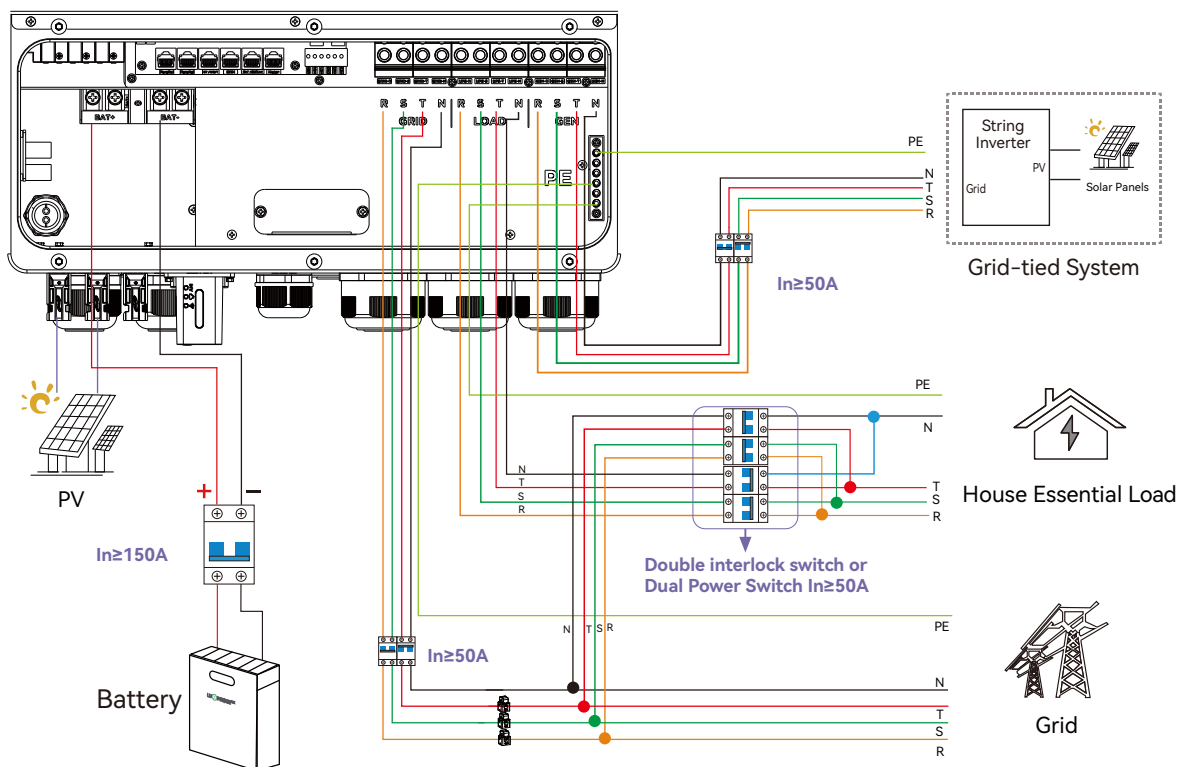

Operating Procedures

Step 1: Ensure that the inverter, grid-tied inverter, and the grid are all powered off, with all circuit breakers in the off position.

Step 2: Connect the output terminals of the grid-tied inverter (R, S, T, N, PE) to the corresponding GEN port terminals on this inverter:

- a. L (Line) → GEN port R/S/T
- b. N (Neutral) → GEN port N
- c. PE (Protective Earth) → Inverter grounding terminal

Step 3: It is recommended to install a dedicated circuit breaker in the AC Coupling loop to ensure safe operation.

5.10.2.3 AC Coupling Settings

enable AC Coupling

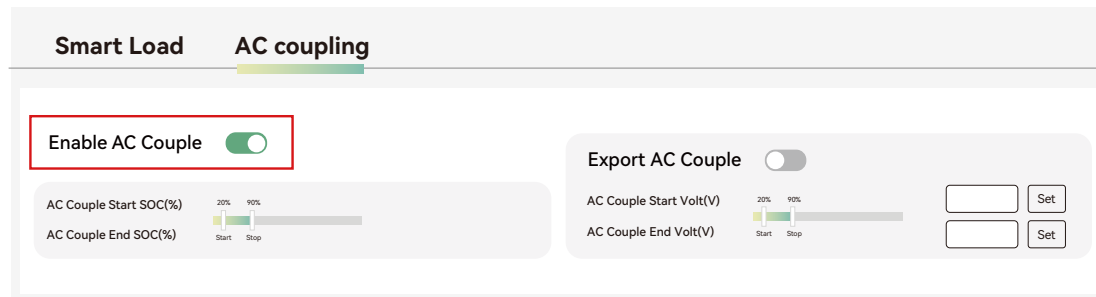

Start Condition: When the battery SOC \geq the preset “AC Coupling Start Threshold”, the on-grid inverter begins operation. Its output power can be used to charge the battery or supply the load.

Stop Condition: When the battery SOC \leq the preset “AC Coupling Stop Threshold”, the on-grid inverter stops operating to prevent battery over-discharge.

Recommended Settings:

Start Threshold (SOC): Approximately 50%

Stop Threshold (SOC): Approximately 90%

When both Grid Connection and Feed-in to Grid functions are enabled, the AC-coupled inverter will remain active and feed any surplus energy into the grid. Please ensure that grid feed-in is legally permitted in your region before enabling this function.

When the Feed-in to Grid function is disabled, the AC-coupled inverter will remain off and will not export power to the grid in on-grid mode.

When connecting an AC-coupled system, please install the power meter as shown in the diagram below to accurately monitor the AC coupling power.

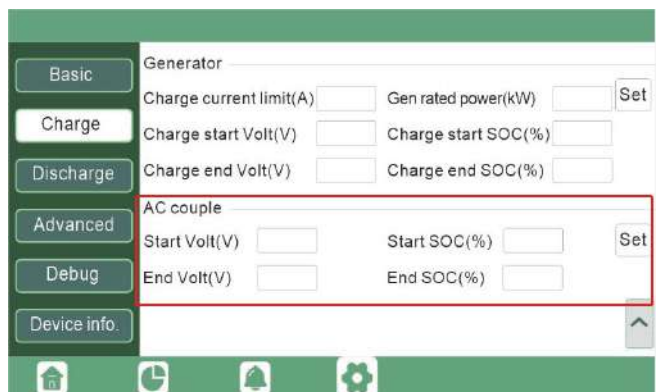
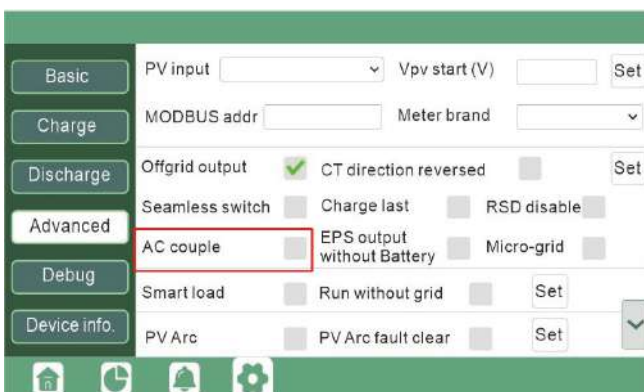
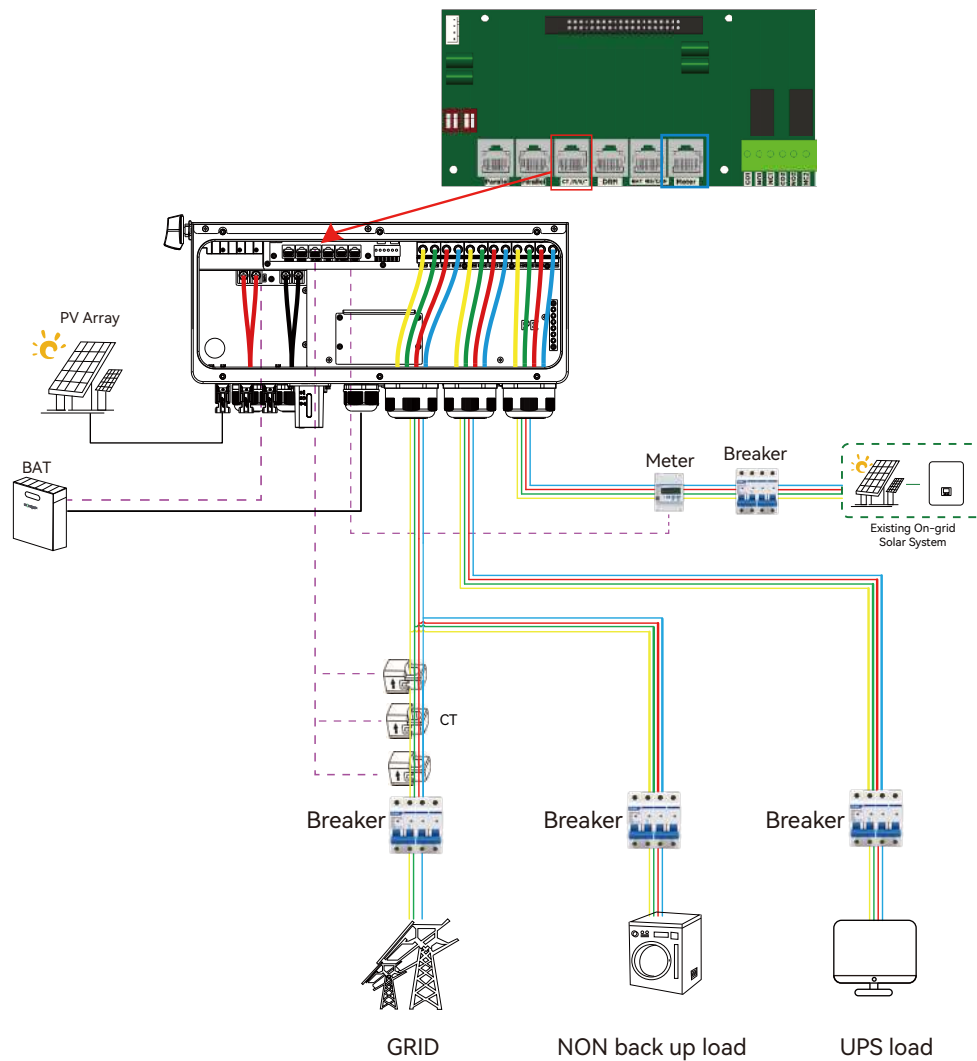

5.10.3 Smart Load

5.10.3.1 Function Overview

The Smart Load function automatically activates designated loads (such as water heaters or EV chargers) when battery energy is sufficient and PV generation is surplus. This improves the utilization of clean energy and prevents resource waste.

When battery energy is low or generation decreases, the system automatically disconnects the smart load to prioritize continuous power supply to essential household loads.

5.10.3.2 Wiring Instruction

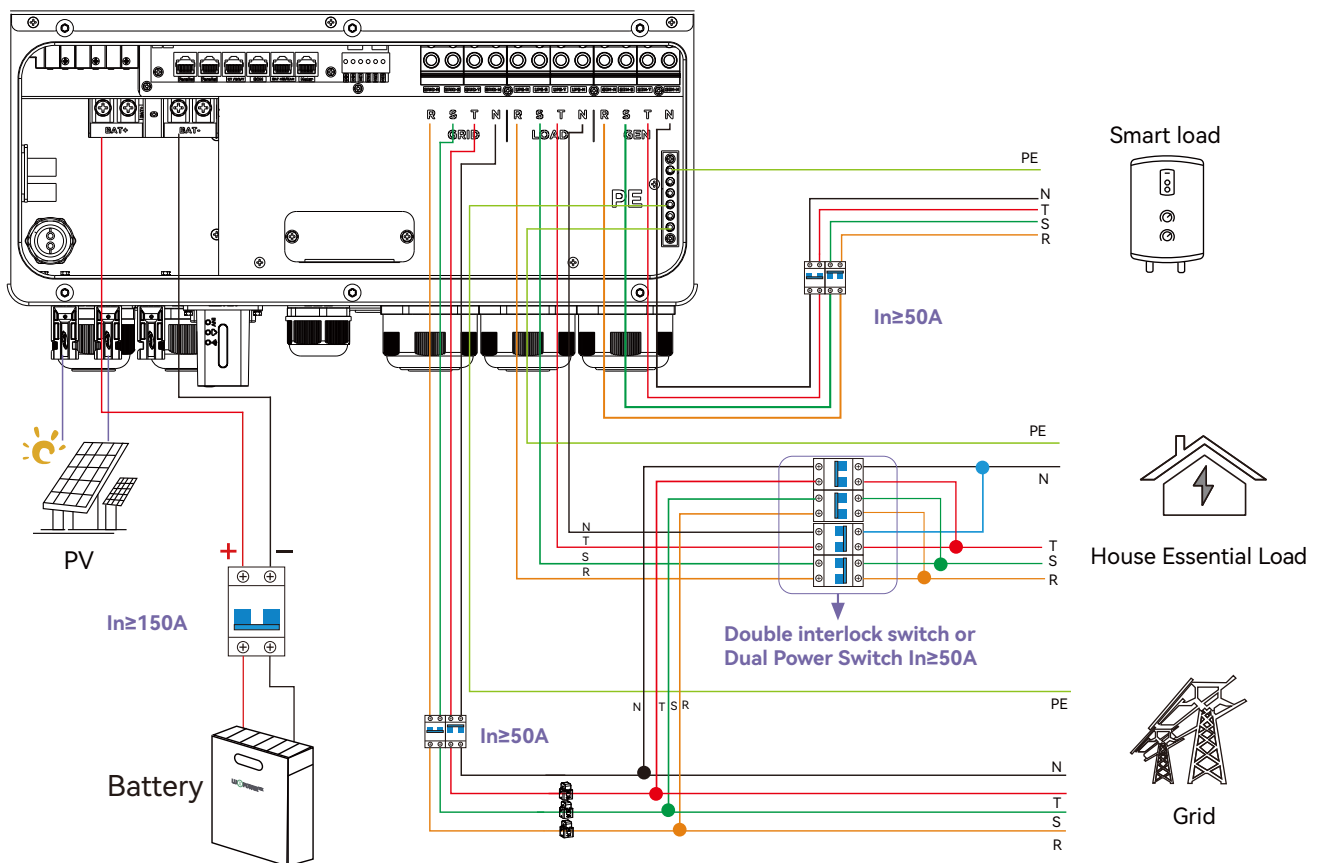

- 1: Ensure that both the inverter and external loads are powered off, and all circuit breakers are in the OFF position.
- 2: Identify and connect the Smart Load wiring according to the standard wiring color code:
 - a.L (Live): R(Yellow), S(Green), T(Red)
 - b.N (Neutral): Black
 - c.PE (Ground): Yellow/green
- 3: Connect the L and N wires of the Smart Load to the corresponding GEN terminals, and connect the PE (ground) wire to the inverter grounding terminal.
- 4: It is recommended to install a dedicated circuit breaker (e.g., 50 A / 2P or compliant with IEC 60947) on the Smart Load branch circuit to ensure operational safety.

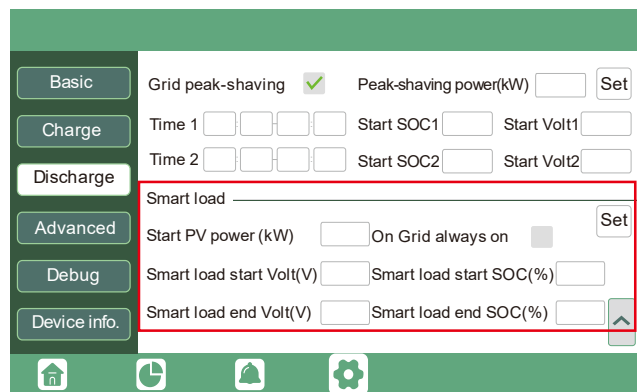
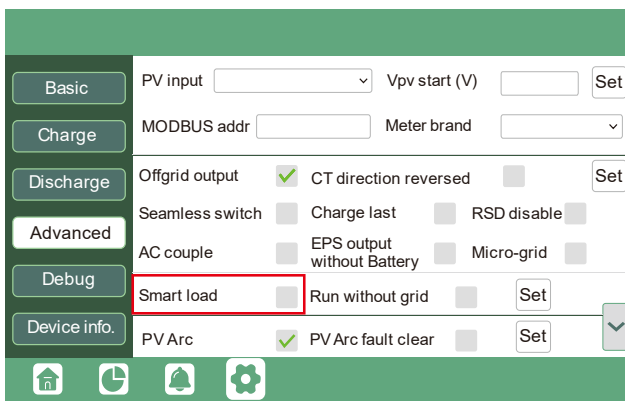
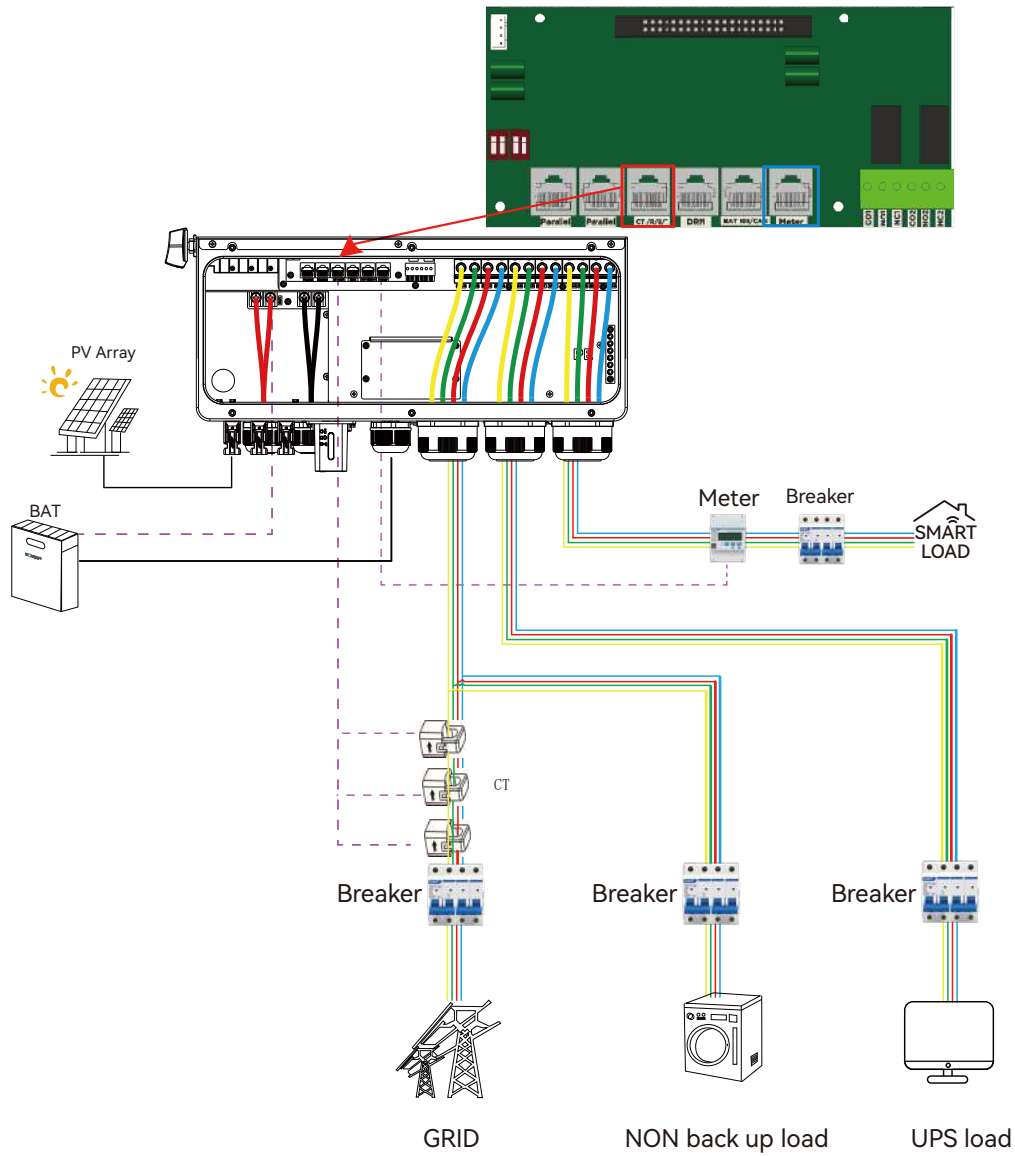

WARNING

When the Smart load is switched on, it is forbidden to connect the generator at the same time, otherwise the device will be damaged !

5.10.3.3 Smart Load Settings

Enable smart load

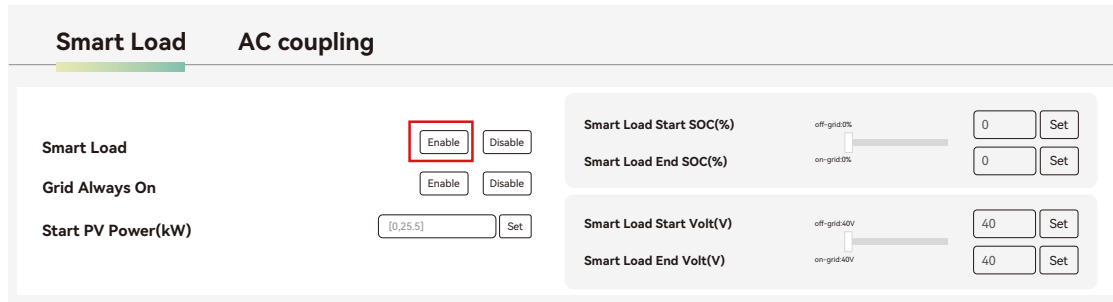

Enable “Grid always on”: When connected to the grid, the smart load remains continuously connected.

Start PV Power: Input the PV power threshold at which you want the smart load to start. You can also input the battery's SOC or voltage to select when to start and stop.

5.10.3.4 Example applications

- Automatically start a water heater when PV generation is sufficient.
- Enable EV charging after the battery is fully charged.
- Run high-power household appliances during off-peak periods using remaining energy.

5.11 Inverter Wiring

5.11.1 Wiring Diagram

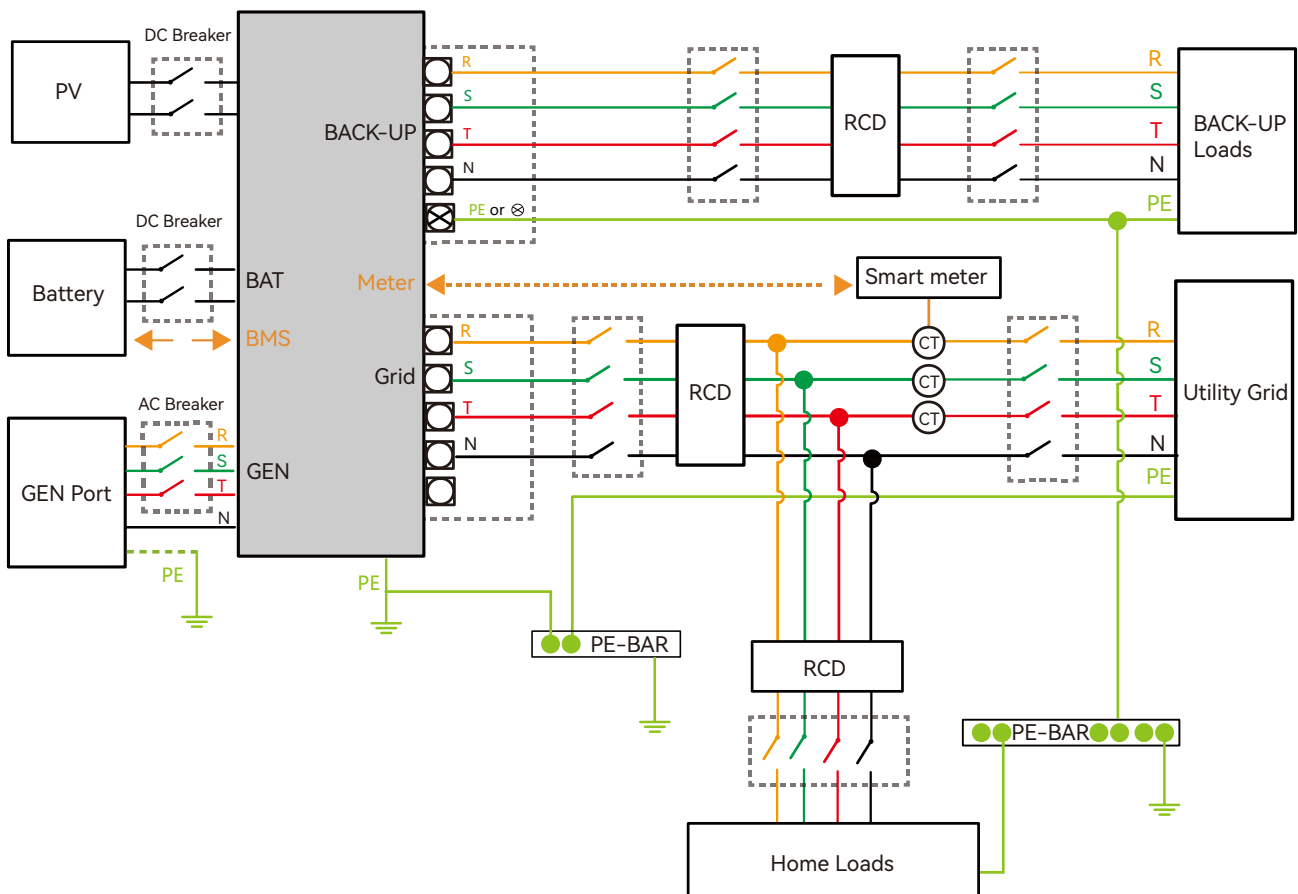

5.11.2 Parallel Wiring

NOTICE

- The TriP2-LB-3P 5-20K inverter features a designated parallel communication interface that can be linked to the TriP2-LB-3P 5-20K using the CAN protocol. This enables the TriP2-LB-3P 5-20K to gather information from parallel machines, such as multiple machines utilizing the same battery.
- For parallel communication connection, utilize a CAT5 or higher-grade straight-through network cable with a 568B configuration to connect to the inverter.
- If parallel communication is needed, please reach out to Luxpower to confirm the information and update the program.

The parallel communication interface is shown in the diagram below:

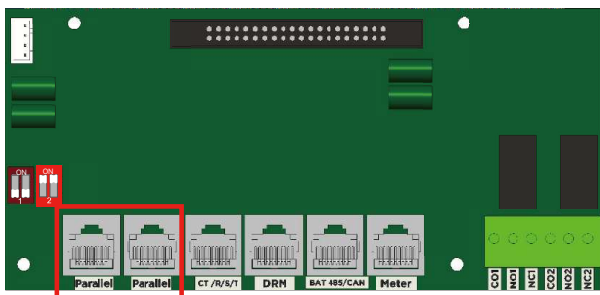

The pin definitions of the parallel communication interface are as follows:



PIN	Function Description
1	NC
2	GND
3	NC
4	CAN-H
5	CAN-L
6	Parallel A
7	Parallel B
8	Parallel C

Please put the CAN communication PIN to on status for the first and the end inverter
Turn the DIP switch ON the right side inside the first and last machine to ON.

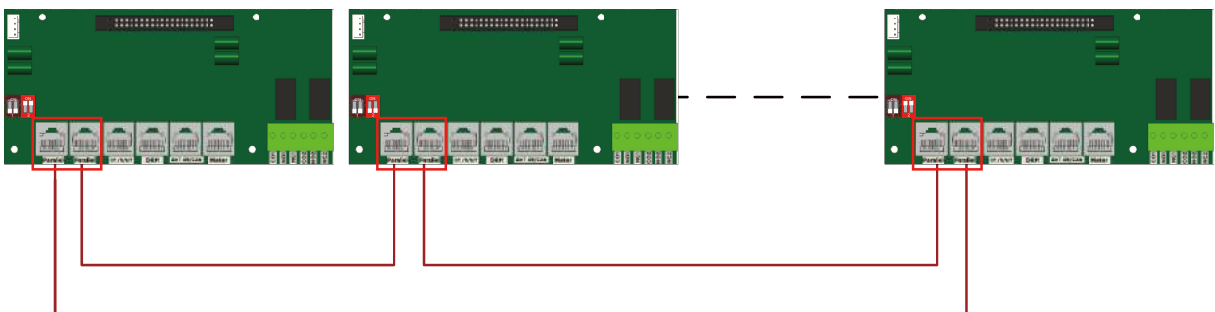

If the parallel cable is not enough or long enough, please make a straight pin to pin cable

Three phase parallel connection diagram:

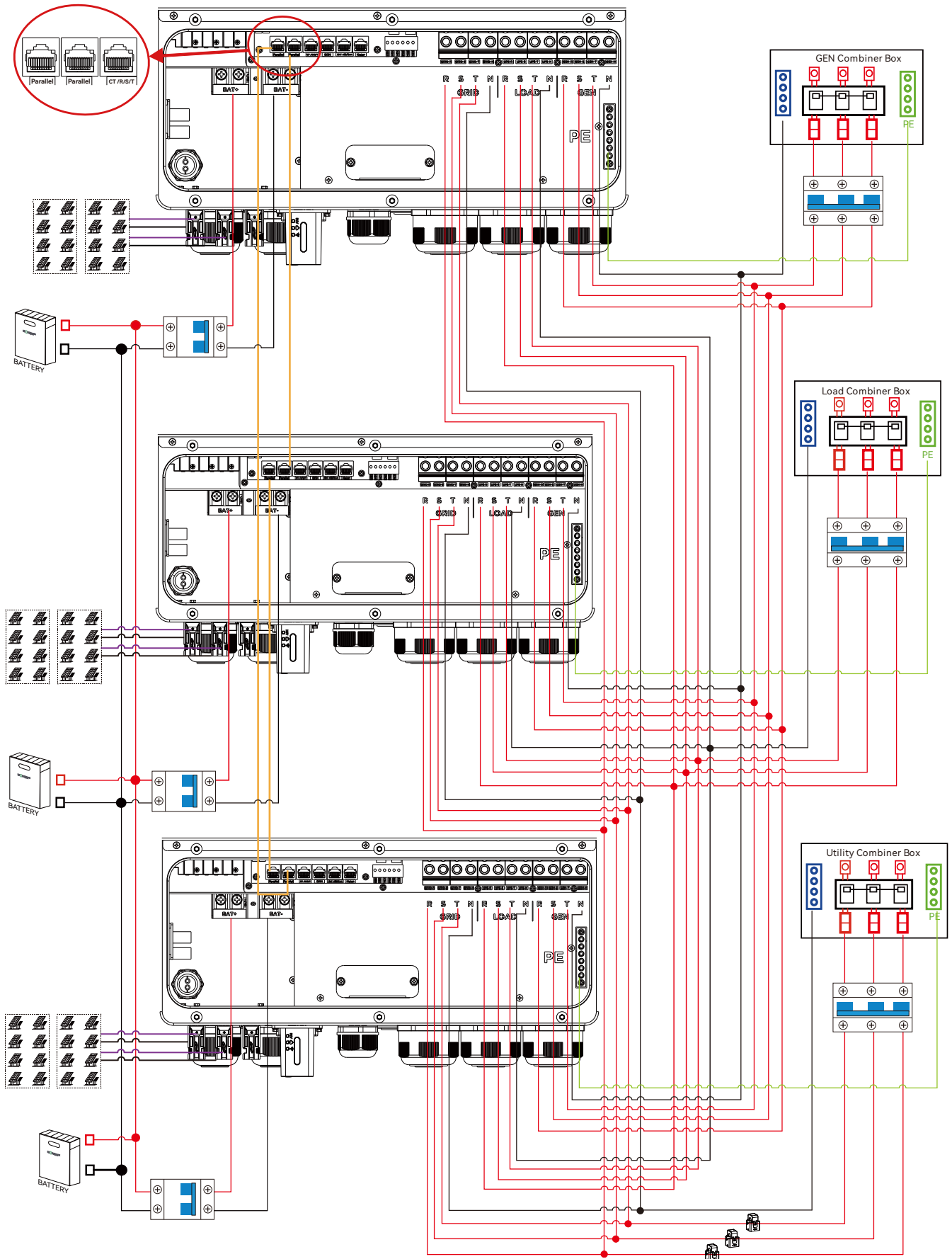

5.12 Installing the Communication Module

Install the communication module at the designated interface as shown in the diagram and secure it with the provided screws.

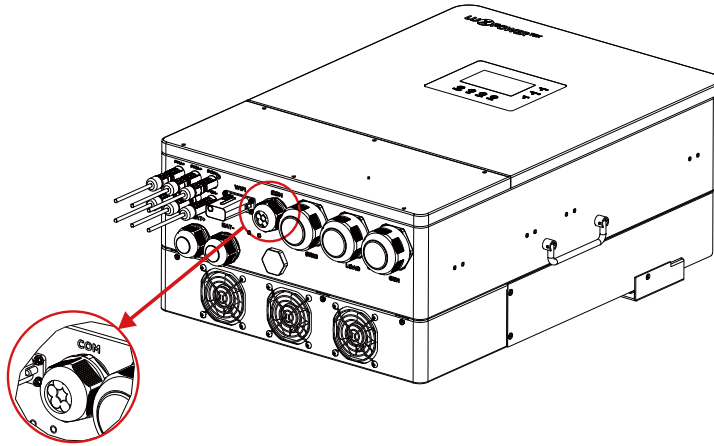

6. Operation Instructions

6.1 Indicator Lights and Button Introduction

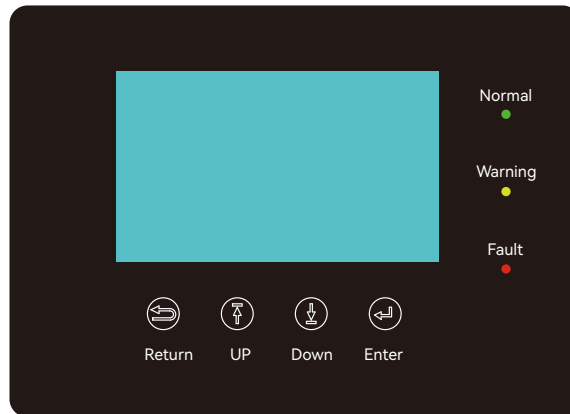

Normal	Green LED		Working normally	
			Firmware upgrading	Wait till upgrading complete
Warning	Yellow LED		Warning, inverter working	Need troubleshooting
Fault	Red LED		Fault, inverter stop work	Need troubleshooting

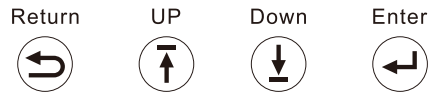

Button	Function
Return	Exit
Enter	Confirm, Enter menu
Up	Previous step or Slide right
Down	Next step or Slide left

6.2 Monitoring Connection

Users have the capability to monitor the inverter through WiFi/WLAN/4G/2G encryption devices, allowing the viewing of monitoring data on a computer or remotely on a smartphone. To initiate this process, kindly download the LuxPower app from Google Play or the Apple App Store and proceed to log in to your user account.

6.2.1 Sign up an account on the mobile phone APP or Website

The "customer code" is a unique code assigned to your distributor or installer. For this code, please contact your supplier directly.

The screenshot shows the website's login and registration interface. At the top is the LuxPower logo. Below it are input fields for 'Username' and 'Password'. There are checkboxes for 'Remember me' (checked) and 'Auto login'. A green 'LOGIN' button is present, along with a 'Forget password?' link. Below the login section, there is an 'or' separator. Underneath are several buttons: 'REGISTER', 'DONGLE CONNECT', 'PRODUCT WARRANTY', 'LOCAL CONNECT', and 'DOWNLOAD FIRMWARE'.

The screenshot shows the mobile app's registration form. It includes the following fields:

- * Cluster: North America (dropdown)
- * Username
- * Password
- * Repeat password
- Real name
- * E-mail
- Tel number
- * Station name
- * Daylight saving time: (toggle switch)
- * Continent: North America (dropdown)
- * Region: North America (dropdown)
- * Country: United States of America (dropdown)
- * Time zone: GTM-5 (dropdown)
- * Address
- * Customer code (Distributor/Installer code)
- * Dongle SN
- * Dongle PIN

 A green 'REGISTER' button is at the bottom.

6.2.2 Station and WiFi Dongle Creation

Upon registration, the station and WiFi dongle will be automatically generated. If you require additional stations to be created, follow the steps below.

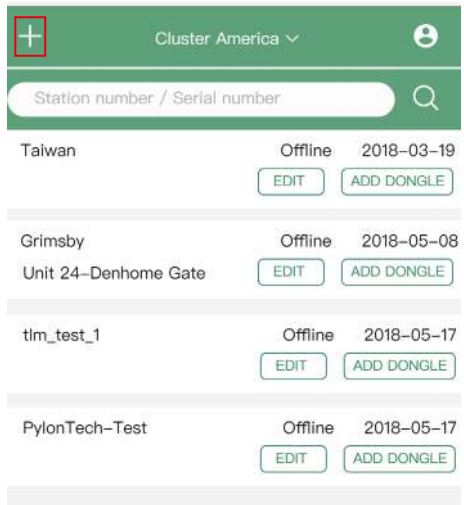

6.2.3 Set homewifi password to dongle

Follow these steps to set the home WiFi password for the dongle.

1. Connect your mobile phone to the "BAxxxxxxx" wireless network, where "BAxxxxxxx" is the serial number of the WiFi dongle.
2. Click the "DONGLE CONNECT" button on the app.
3. Choose the home WiFi to which the WiFi dongle will be connected, and enter the WiFi's password. Then, click "HomeWifi Connect". The WiFi dongle will restart and attempt to connect to the server automatically.
4. Check the LEDs' status on the WiFi dongle. The middle light should be solid when the WiFi dongle successfully connects to our server.

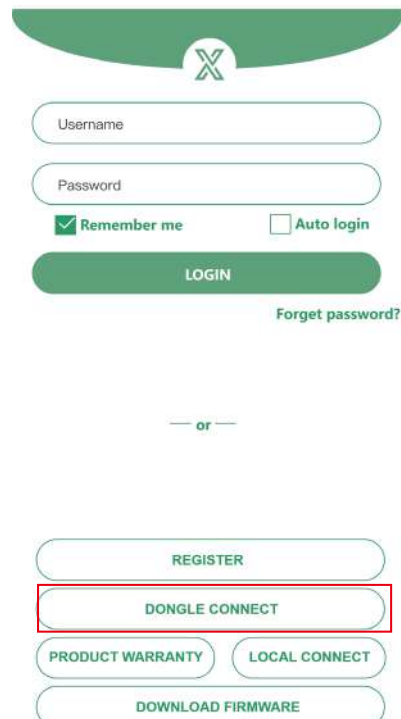

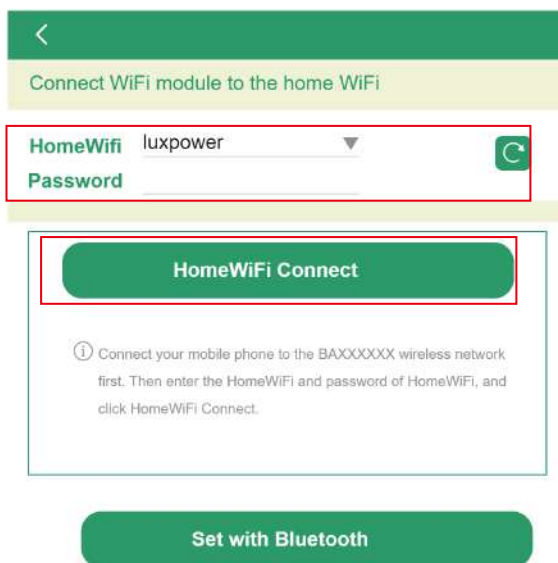

5. Disconnect your mobile phone from the "BAxxxxxxx" wireless network. Log in to the app with your account and you will find the inverter information already visible. Now, you'll have the capability to monitor and control the inverter remotely using any smartphone or computer with an internet connection. you'll find the inverter information already appears. Now you'll be able to monitor and control the inverter remotely on any smart phone or computer that has an Internet connection.

Please download the following guides for setting up WiFi dongle and monitoring account at Document Reference:

1. Wifi Quick Guidance

Quick guidance for setting connection of WiFi module to home WiFi, you can also find a printed version in the packaging of the WiFi module.

2. Monitor system setup for Distributors and Monitor system setup for endusers

Account registration, the description of each item and parameters, setting parameters

3. Monitor_UI_Introduction

Introduction of monitor interface

6.3 LCD Interface Settings Introduction

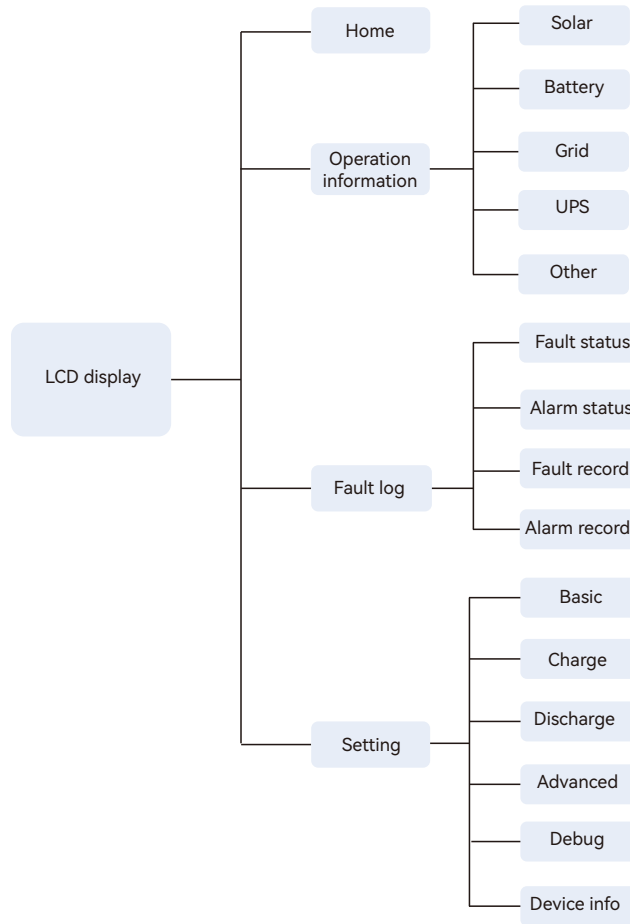

There are four main interfaces on the LCD: Home, Operation Information Query, Alarm, and Fault Record, Settings, as shown in the diagram below.

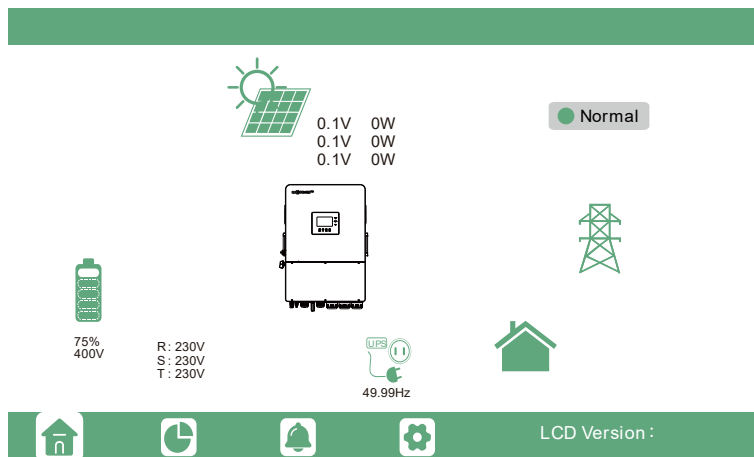

If the LCD is in sleep mode, simply touch the screen to wake it up. Upon activation, the home interface will be displayed. This interface provides users with a comprehensive overview of the system, including real-time information for each component. Key metrics such as Battery State of Charge (SOC), battery charge/discharge power, grid import/export power, load power, etc, will be readily accessible.

By touching the operation information icon on the LCD, users can view rea-time operational data for various components, including Solar, Battery, Grid, UPS, etc. This feature allows for a detailed and up-to-the-minute understanding of the system's performance and individual component metrics.

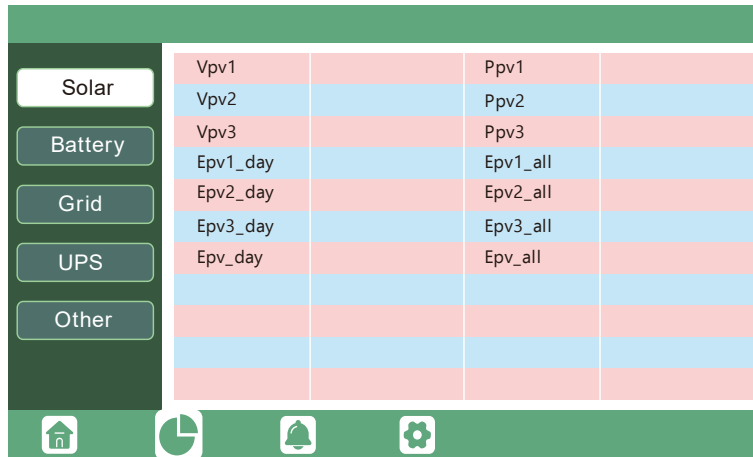

By touching the fault record icon at the bottom of the screen. This section displays both current and-historical fault and warning information. It serves as a valuable tool for monitoring and addressing any issues that may have occurred during the system's operation.

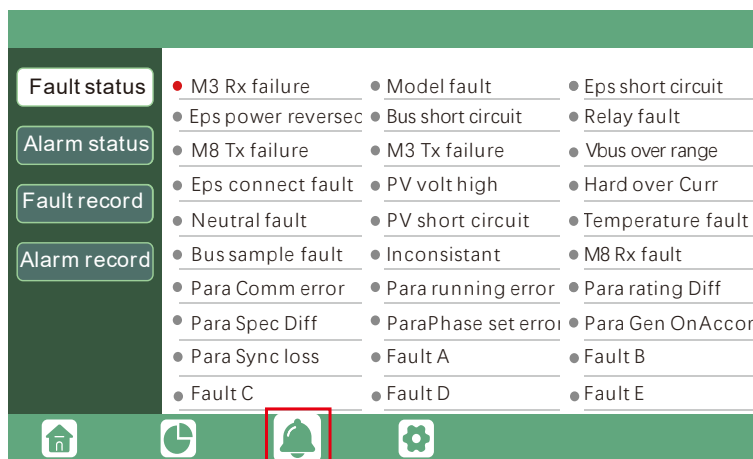

By touching the settings icon at the bottom of the screen, users can access all the machine's settings on that page. This section allows for configuration adjustments and customization of various parameters. For detailed mode settinas please refer to the following chapter on operation mode settings.

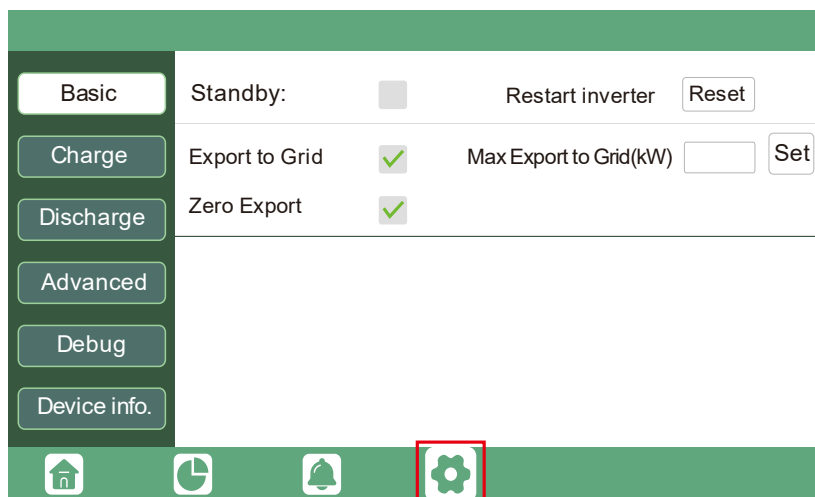

6.4 Operating Mode Settings

6.4.1 Self-consumption Mode

In this mode, the priority order of load supply sources is Solar>Battery>Grid. The priority order of solar power usage is Load>Battery>Grid.

When solar power is sufficient, it will take the load, then charge the battery, and finally feed excess power back into the grid (if the feedback function is enabled).

In cases where solar power alone is insufficient for the load, both solar and battery will contribute. If the battery is empty, the grid will be utilized to meet the load.

When the battery is unable to supply power, priority shifts to using solar power for the load. If solar power is insufficient the grid becomes the source of power for the load.

If both solar power and the battery are unable to supply power, the load will be sourced from the grid.

Application Scenarios

Self consumption mode will increase the self consumption rate of solar power and reduce the energy bill significantly.

Related Settings

This mode is set as the default mode, effective when Charge Priority , AC Charge, and Forced discharge are disabled.

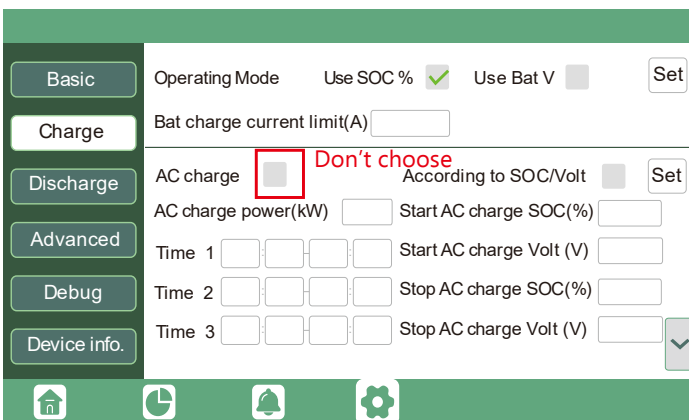
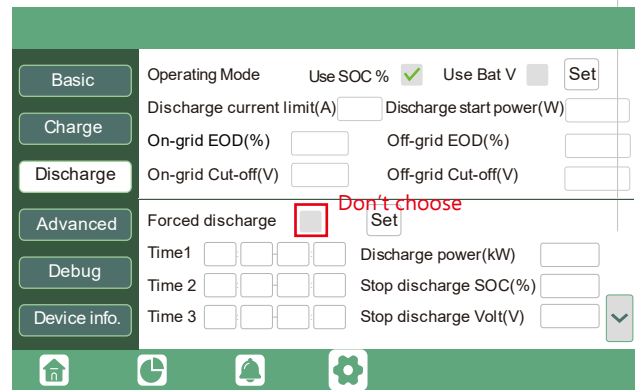
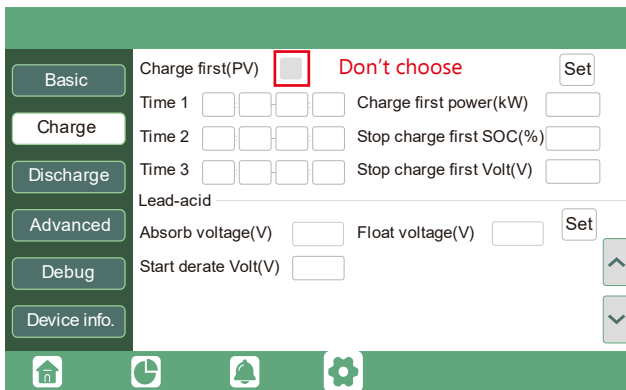

To export power to the grid, enable the "export to grid" option, ensuring compliance with local grid regulations.

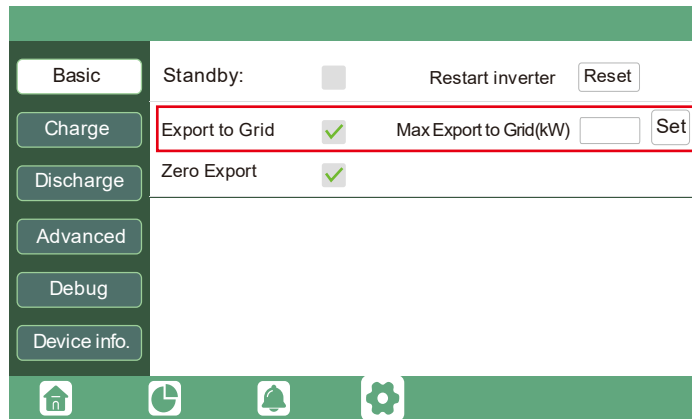

Example:

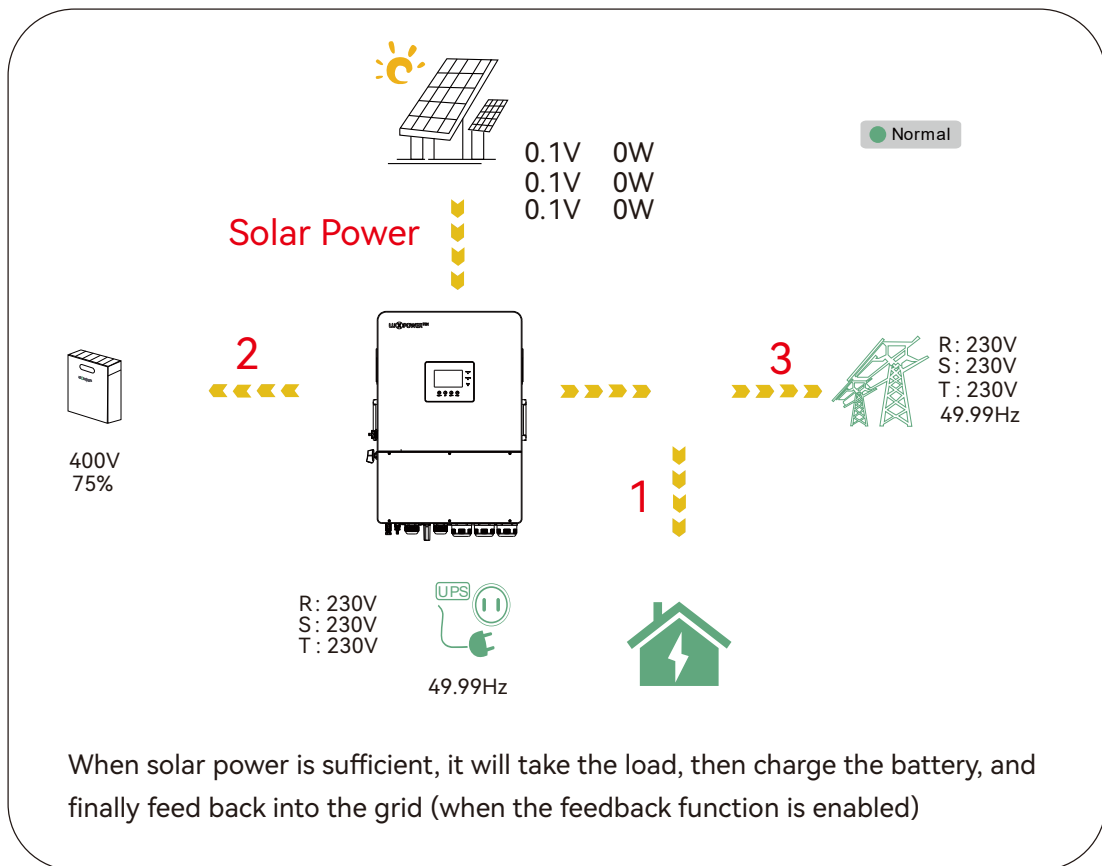

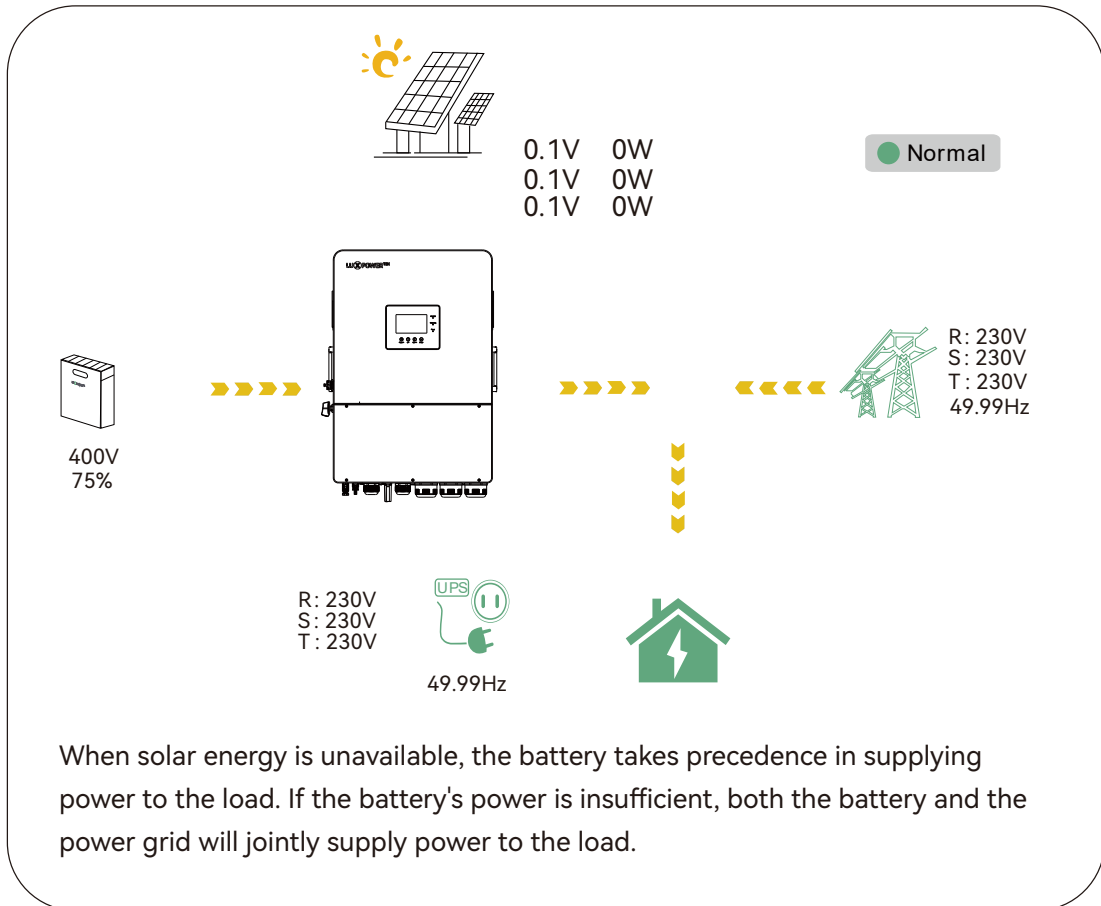
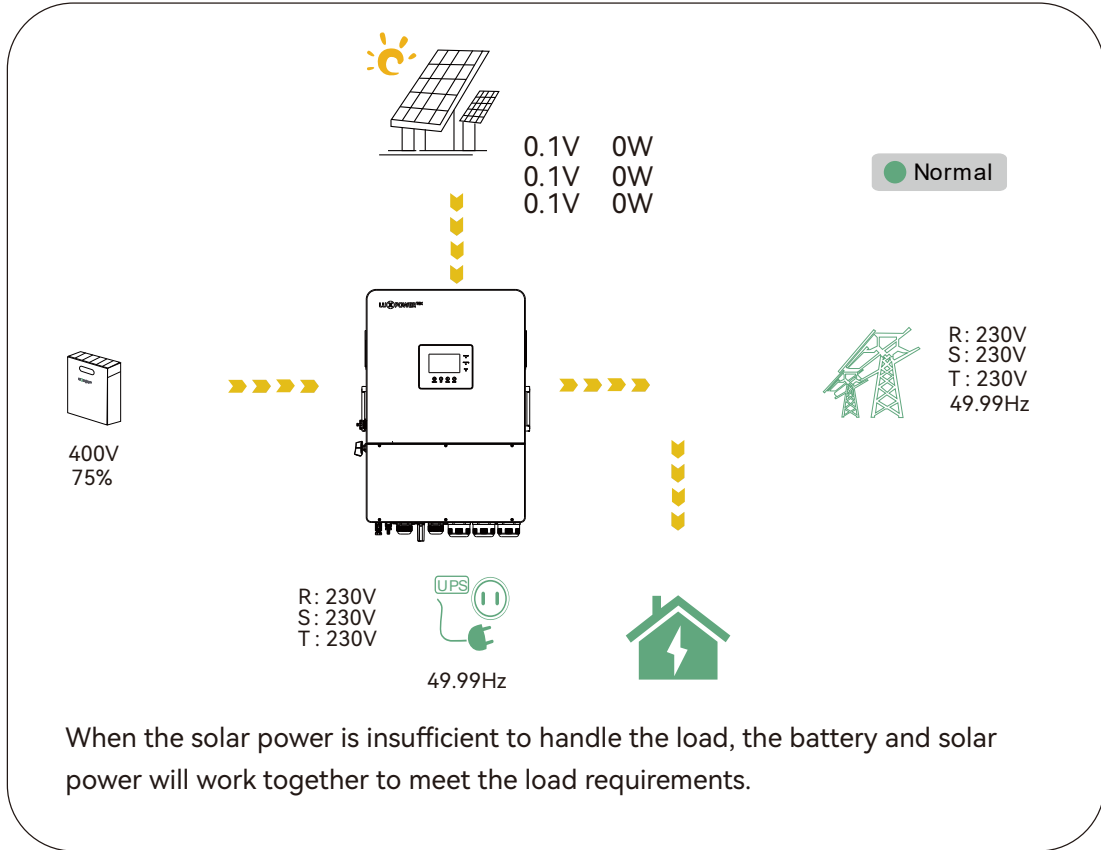

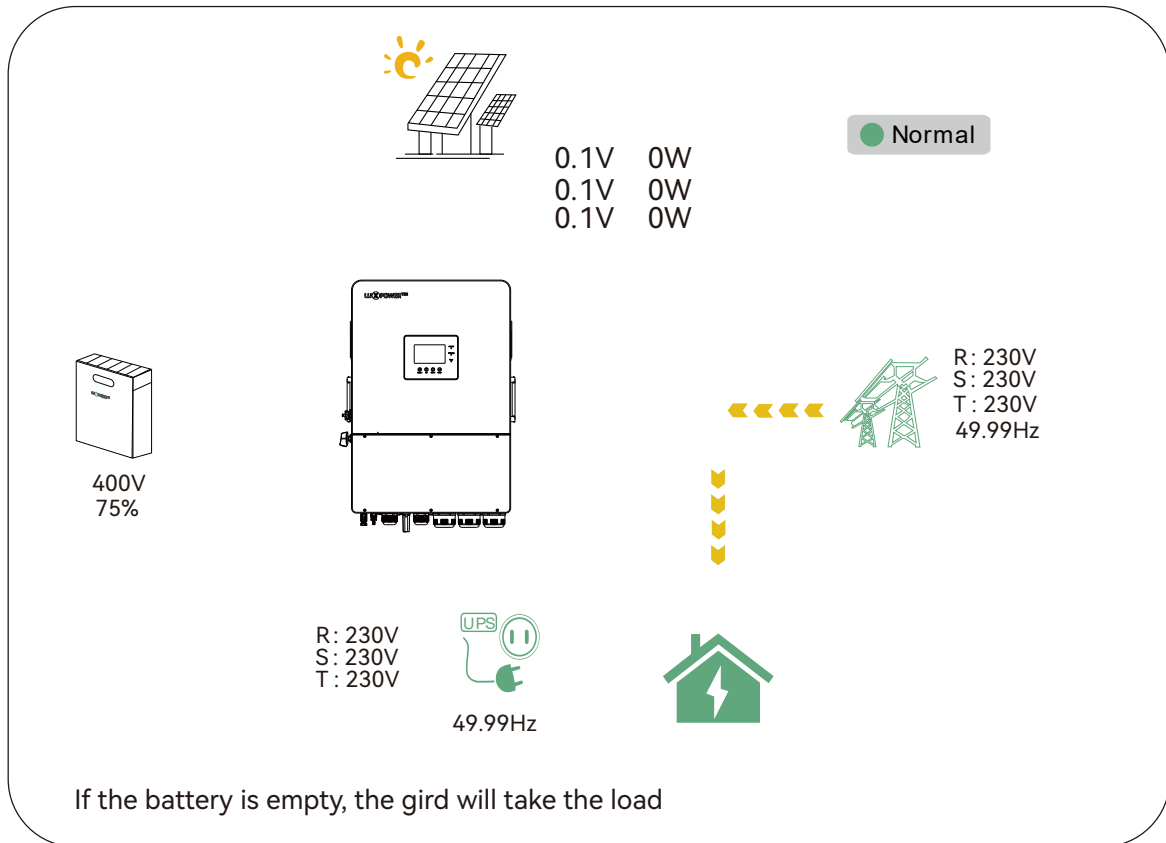

6.4.2 Charge First Mode

In this mode, the priority order for solar power usage is Battery > Load > Grid. During the Charge Priority time period, grid power is prioritized to supply the load. If there is excess solar power after battery charging, the surplus solar power will be used together with grid power to supply the load.

Application Scenarios:

This mode is suitable when users prefer to use solar power for battery charging, and grid power is used to supply loads.

Related Settings

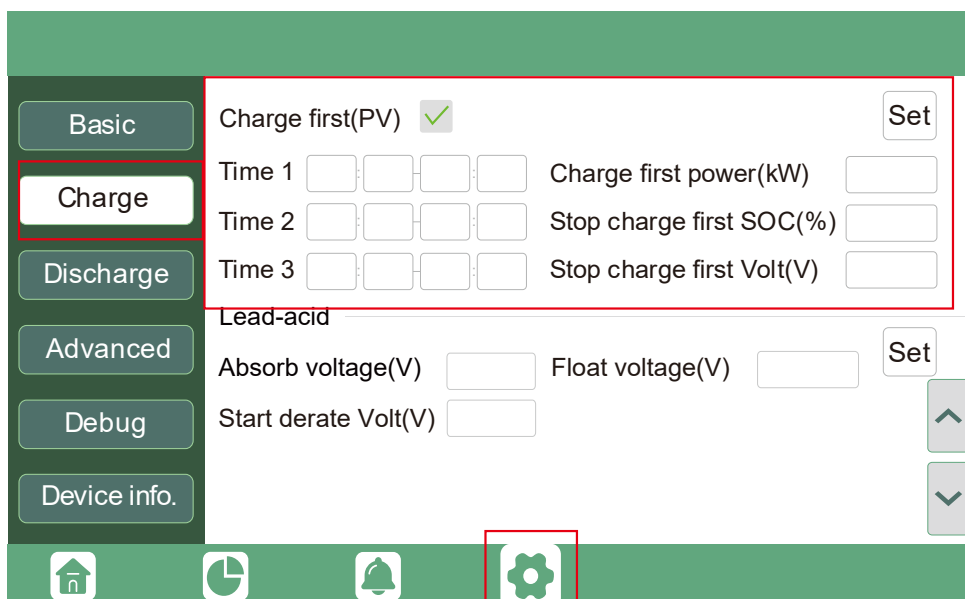

Example:

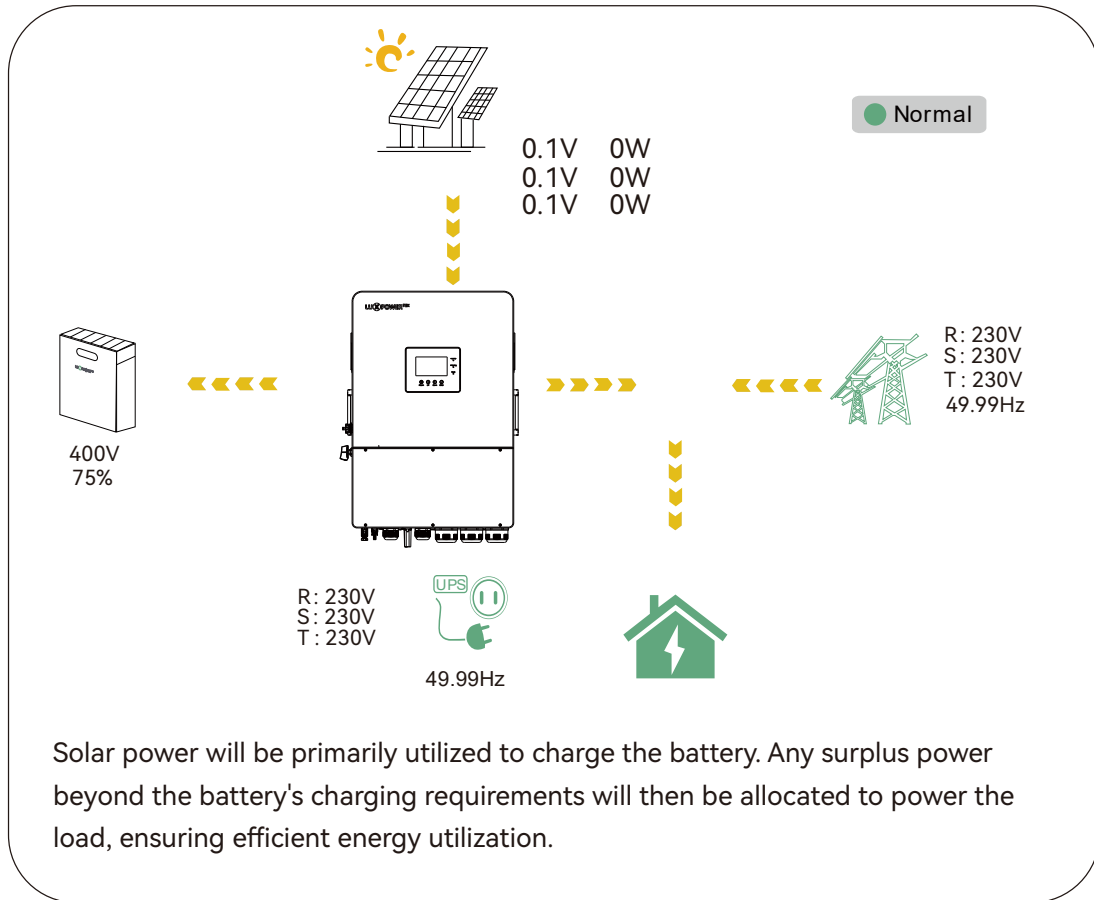

6.4.3 Forced Charge Mode

In this mode, users can configure AC charging to charge the battery from the grid during periods of low electricity prices. Additionally, battery discharging can be set to supply power to loads or feed excess power back to the grid during periods of high electricity prices.

Application Scenarios

This mode is ideal for areas with notable variations in peak and off-peak electricity tariffs.

Example:

AC Charge Mode

Users have the flexibility to configure the inverter for either a direct charge or a charge based on the battery State of Charge (SOC) and voltage over a specified duration.

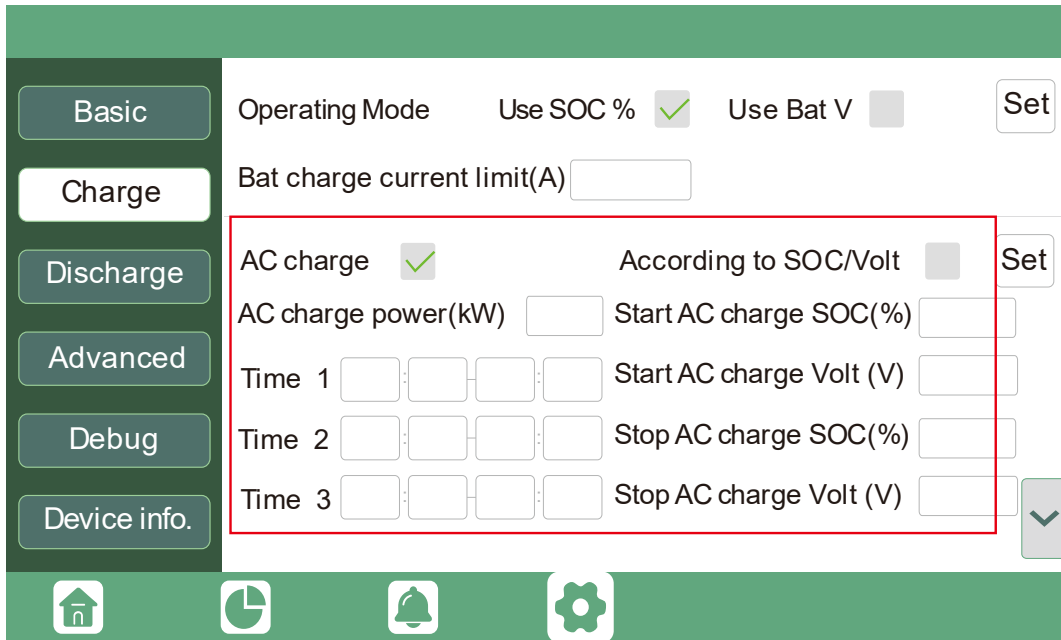

Discharge Mode

Discharging settings options

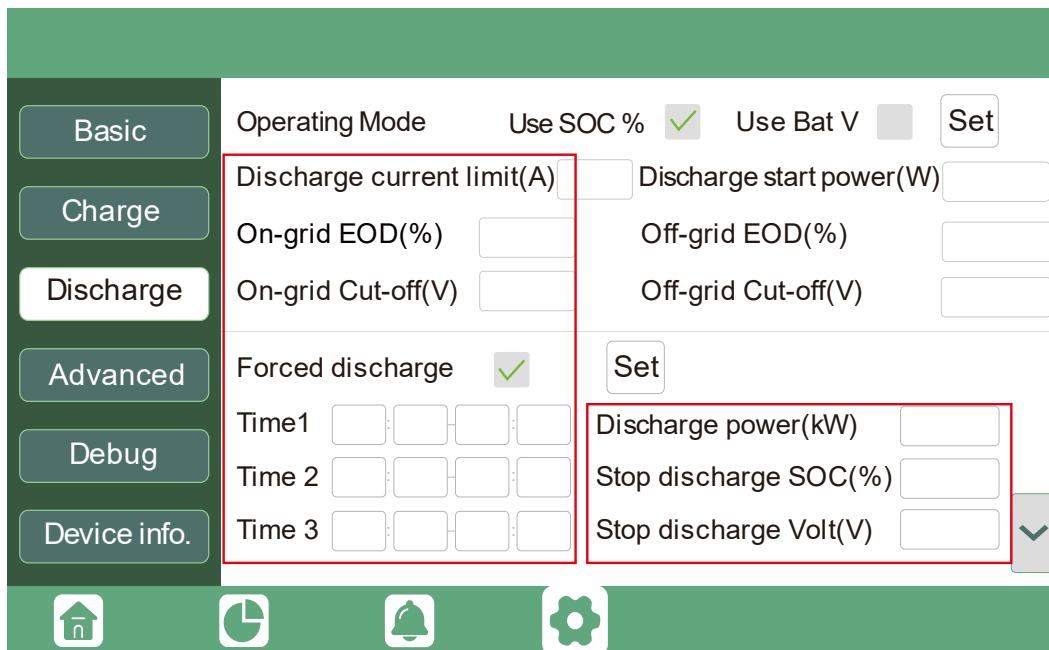

Discharge current limit(A): The Max. discharge current from Battery

Discharge start power(W): The default value is 0

When the inverter detects the import power is higher than this value, battery start discharging, otherwise battery will keep standby

On-grid Cut-off(%) and Off-grid Cut-off(%)

On-grid Cut-off(V) and Off-grid Cut-off(V):

End of discharge SOC/Cut off voltage in on-grid and off-grid condition respectively.

Forced discharge: Settings for battery force discharge within certain time period.

In the preset time period, the inverter will discharge battery at the power set by “discharge power”, until battery SOC or voltage reaches “Stop discharge ”value.

6.4.4 Off-grid Mode

When the grid is interrupted, the inverter switches to Off-grid mode to supply power to critical loads; when the grid is restored, the inverter switches to On-grid mode to operate. (Mainly applicable to unstable grid and critical loads)

Off-grid settings options

You can set the Off-grid output enable and also the battery Off-grid stop discharge SOC and Cut-off voltage.

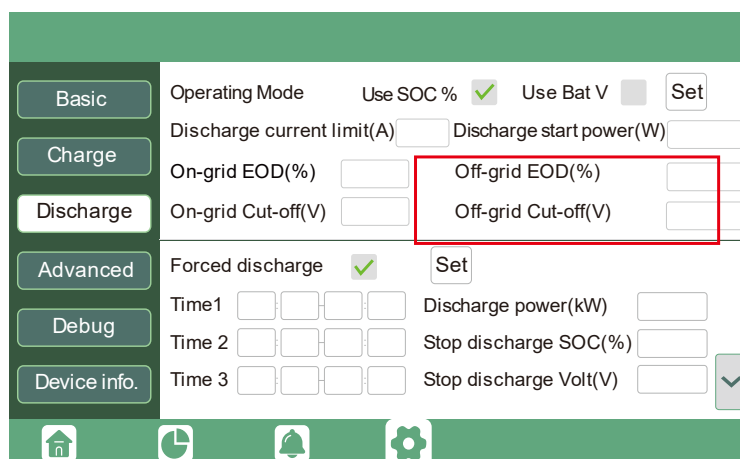
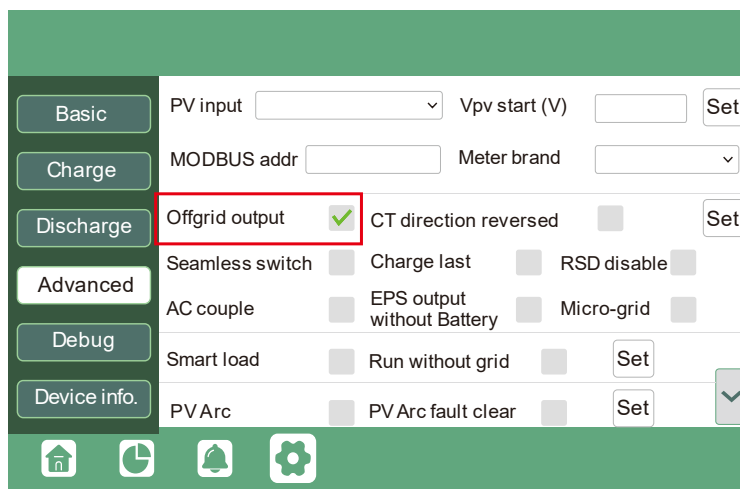

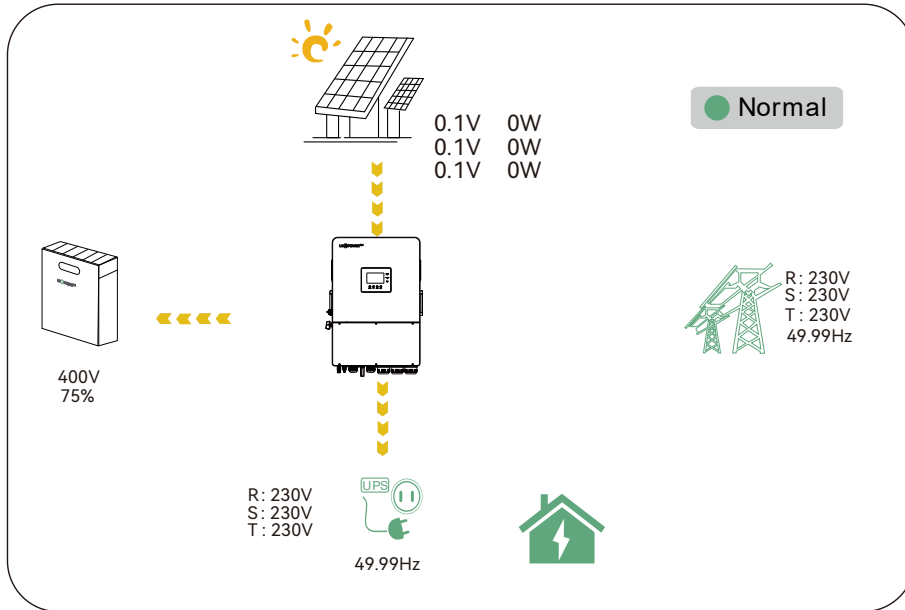

In situations where no battery is present, users can enable individual off-grid functionality for the PV system. This can be achieved by selecting the "No battery" type and subsequently choosing the EPS output without battery.

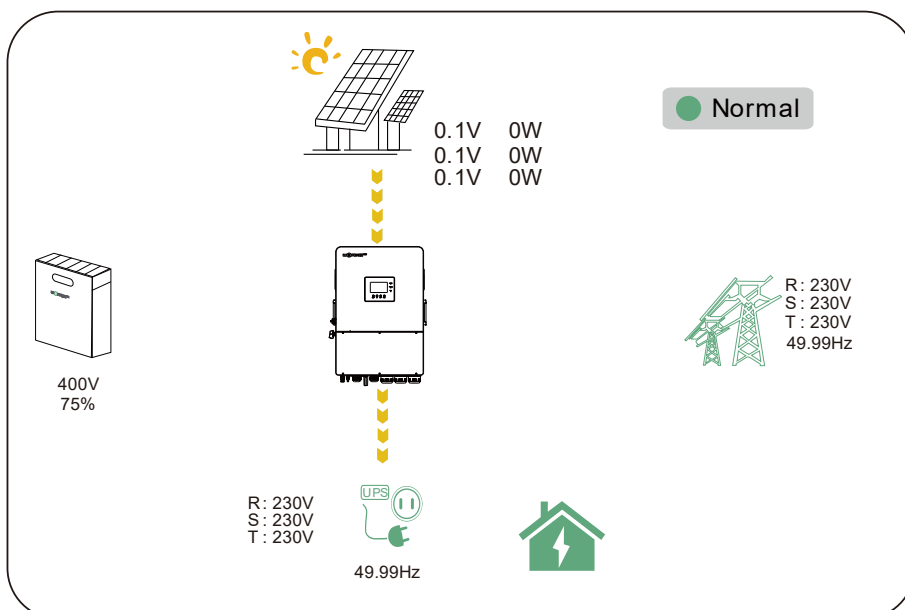
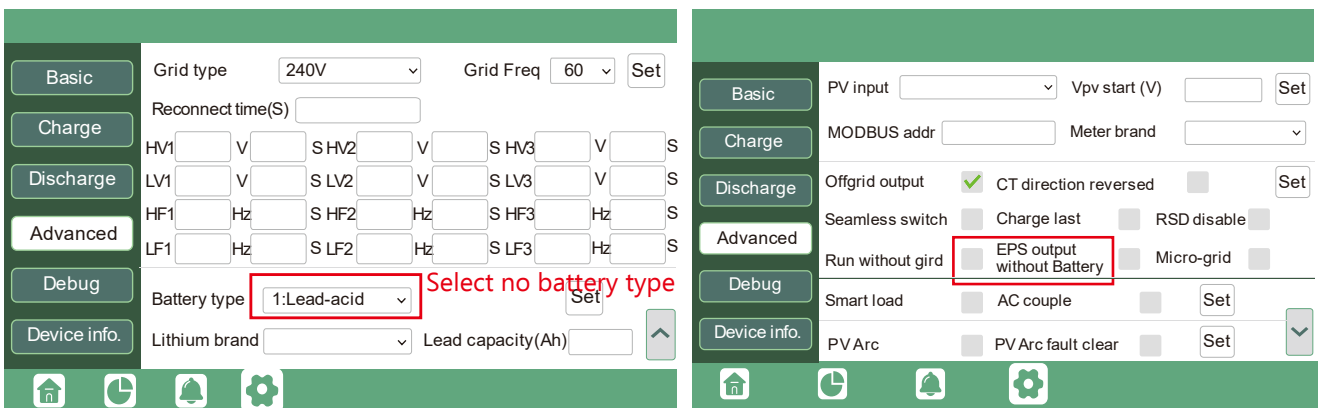

6.5 Grid Peak-shaving Function

Grid peak-shaving & Grid peak-shaving power(kW)

Is used to set the maximum power that the inverter will draw from its grid power.

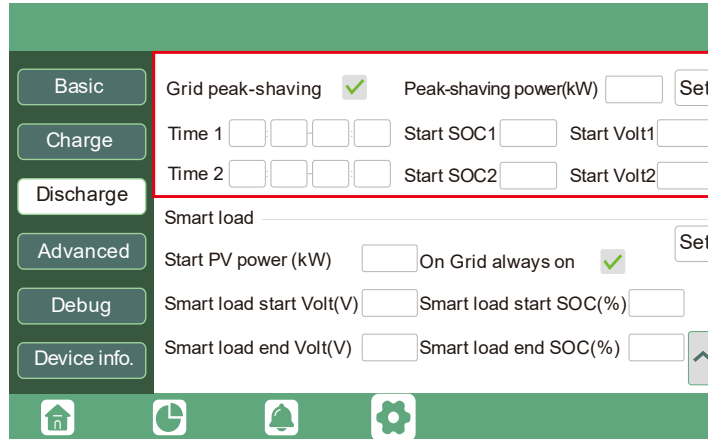

6.5.1 Setting Parameters

By clicking on the gear icon at the bottom of the screen, you'll access the inverter's parameter setting page

(1). Basic settings

Restart inverter: This option allows you to restart the system. Note that power may be interrupted during the restart.

Export to Grid: This setting is used for enabling or disabling the zero export function. If exporting solar power is not allowed, disable the "Export to Grid" option. Enabling "Zero export" ensures that export detection and adjustment occur every 20 milliseconds, preventing any solar power from being exported. If export is allowed, enable "Export to Grid" and set a maximum allowable export limit in "Max. Export to Grid (kW)".

Standby: This setting allows you to switch the inverter between normal and standby status. In standby status, the inverter will cease charging, discharging operations, and solar feed-in.

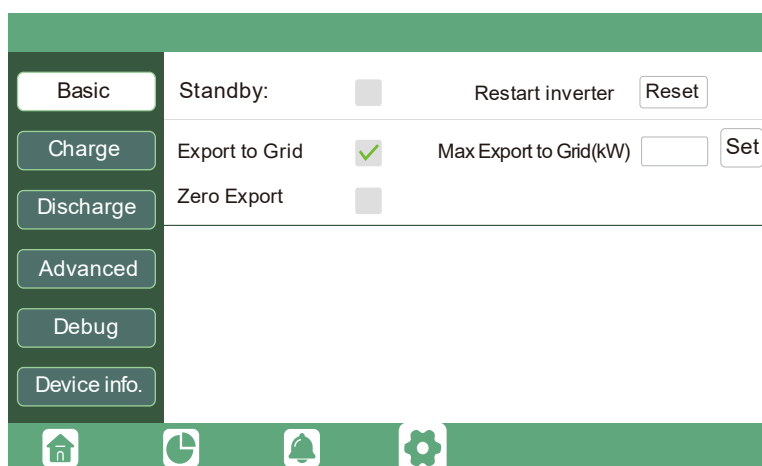

6.5.2 Charge setting

Operating Mode : Users can decide to use SOC or BatV to control charge and discharge logic depending on battery type.

Bat charge current limit(A): Users can set Max charge current.

AC Charge: Utility charge.configuration If users want to use grid power to charge their battery, then they can enable “**AC Charge**”, set time periods when AC charging can happen, AC Charge power(kW) to limit utility charging power, and “**Stop AC Charge SOC(%)**” as the target SOC for utility charging. “**Stop AC Volt(V)**” as the target battery voltage for utility charging.

Charge first: PV charge configuration. When using enable Charge first, PV will charge the battery as a priority, set time periods when PV charge can happen, charge first power(kW) to limit PV charge power, and “**Charge first SOC(%)**” as the target SOC for PV charge first. “**Charge first Volt(V)**” as the target battery voltage for PV Charge first. Lead acid: When using Lead-acid battery, you need to set parameters in these programs, Follow the battery manufacturer’s recommendation.

Generator

Bat charge current limit(A): Set the Max. battery charge current from the Generator. The Generator will start charging according to the Charge start Volt/SOC, and stop charging when the battery voltage or SOC reaches the Charge end Volt/SOC value.

Gen rated power: Inverter has the peak-shaving function, when you need you can enable it and setup the Gen peakshaving power(W)

6.5.3 Discharge Setting

Operating Mode

You can choose “Use SOC %” or Use Bat V” to control the battery discharge state

Discharge current limit(A): The Max. discharge current from battery

Discharge start power(W): The Min. value can be set to 50.

When the inverter detects the import power is higher than this value, battery start discharging, otherwise battery will keep standby

On-grid Cut-off(%) and Off-grid Cut-off(%)

/On-grid Cut-off(V) and Off-grid Cut-off(V):

End of discharge SOC/Cut off voltage in on-grid and off-grid condition respectively.

Forced discharge: Settings for battery force discharge within certain time period. In the preset time period, the inverter will discharge battery at the power set by “discharge power”, until battery SOC or voltage reaches “Stop discharge ”value.

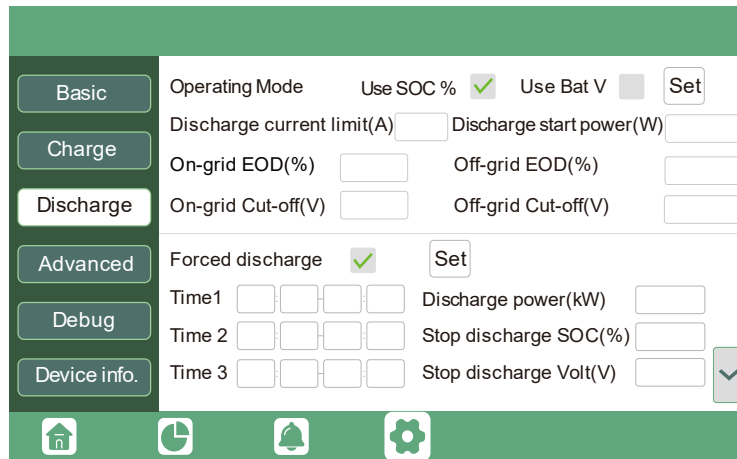

6.5.4 Advanced setting

Advanced setting is mainly by installer after installation.

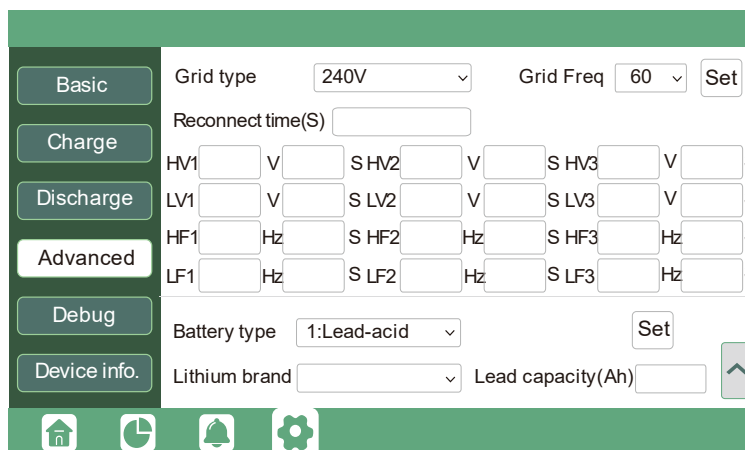

Grid type: You can choose by yourself, 220V, 230V, 240V.

Battery type: No battery, lead-acid or lithium-ion. If lead-acid battery is selected, please input correct battery capacity If lithium-ion battery is selected, please choose the battery brand in the Lithium brand drop down list.

Basic	PV input	<input type="text"/>	Vpv start (V)	<input type="text"/>	Set
Charge	MODBUS addr	<input type="text"/>	Meter brand	<input type="text"/>	
Discharge	Offgrid output	<input checked="" type="checkbox"/>	CT direction reversed	<input type="checkbox"/>	Set
Advanced	Seamless switch	<input type="checkbox"/>	Charge last	<input type="checkbox"/>	RSD disable <input type="checkbox"/>
	AC couple	<input type="checkbox"/>	EPS output without Battery	<input type="checkbox"/>	Micro-grid <input type="checkbox"/>
Debug	Smart load	<input type="checkbox"/>	Run without grid	<input type="checkbox"/>	Set
Device info.	PV Arc	<input type="checkbox"/>	PV Arc fault clear	<input type="checkbox"/>	Set

Meter type: Please select it according to the meter that's to be installed.

Charge last: When users want to use solar power in the order of loads -- grid export -- battery charging.

Offgrid output: It is for users to set if the inverter provides backup power or not when the grid is lost. If users want the load to be seamlessly transferred to the inverter backup power, “**Seamless switch**” must be enabled. If customers don't have a battery installed yet, but still wish to have inverter backup power with only solar panels connected, “**PV Grid Off**” can be enabled to use solar power to supply load when the grid fails or load-shedding happens. Micro-grid: only needs to be set when the generator is connected to the inverter's grid port. With this option enabled, the inverter will use AC power to charge the battery and won't export any power through the grid port if AC power is present at the inverter's grid port.

Role: The Role setting of the parallel system, only one inverter is allowed to be set as Primary, and the others are all Subordinate.

Phase: This is the phase code setting of the EPS output. The system will automatically detect the phase sequence of the inverter (consistent with the phase sequence of the connected Grid mains) and display on the inverter after it is connected to the grid.

Notice:

- (1). All setting of parallel inverters need to be done in Standby or Fault Mode.
- (2). If the system is connected to a lithium battery, the host of the lithium battery needs to communicate with the inverter which is set as Primary in the parallel system.
- (3). Please keep all the setting are same for each inverter in the parallel system on the LCD or Web monitor.

7. Maintenance

7.1 Start and Shutdown the Inverter

Start the inverter

Operating Procedures

Step 1. Make sure the inverter is properly connected to the batteries, panels, grid, etc(see system wiring diagram)

Step 2. Turn on the battery system firstly, then turn on the built-in battery breaker.

Step 3. Turn on PV DC disconnect switch, make sure the PV voltage of the strings are higher than 120V, and check if the inverter works in PV charge or PV charge back-up mode.

Step 4. Make sure step1 to step3 above work properly before turning on the grid power or generator breaker.

Step 5. Turn on the built-in load breaker before providing power to EPS load.

Step 6. Turn on the built-in grid breaker or generator breaker, check if the inverter can go to bypass mode and on-grid mode normally.

Shut down the inverter

⚠ DANGER

Do not disconnect the battery, PV and AC input power under load.

If there is emergency issue, and you have to shut down the inverter, please follow the steps as below.

⚠ WARNING

After powering off the inverter system, there may still be residual electricity and heat in the enclosure, which could cause electric shock or burns. Therefore, it is recommended to wear insulated gloves and wait for 5 minutes after powering off the inverter system before performing any operations on it.

Operating Procedures

Step 1. Turn off the Grid breaker or Generator of the inverter.

Step 2. Switch off the load breaker.

Step 3. Turn off PV breaker and then battery breaker, waiting for the LCD to go off.

7.2 Regular Maintenance

To ensure the long term and proper operation of the inverter, it is recommended that regular maintenance is carried out as described in this section.

⚠ CAUTION

- Do not touch the inverter while it is operating. Certain parts may become hot during operation and can cause burns upon contact.
- Before performing any maintenances—such as system cleaning, electrical connection inspection, or grounding verification—ensure the system is completely shut down and the inverter has fully cooled.
- If the screen or LED indicators become difficult to read due to dust, clean them gently with a soft, dry cloth.
- Do not use solvents, abrasives, or corrosive materials to clean the inverter.

System cleaning (once every 6 months to 1 year)

- Check the heat sink for any obstructions or dust accumulation periodically.

System operational check (once every 6 months)

- Check the appearance of the inverter for damage or deformation.
- Check the inverter for abnormal noises during its operation.
- Check that the inverter parameters are set correctly when the inverter is running.

Electrical connections check (6 months after the first commission, then every 6 months to once a year)

- Check the cable connections for detachment and looseness.
- Check the cable for damage, paying particular attention to the skin of the cable in contact with metal surfaces for signs of cuts.

Ground reliability (6 months after the first commission, then every 6 months to once a year)

- Check that the earth cable is securely in place.

Seal check (once every 6 months)

- Check that all terminals and interfaces are properly sealed.

7.3 Firmware Upgrade

DANGER

- Ensure that the firmware file type and format are correct. Do not rename the firmware file, as doing so may cause the inverter to malfunction.
- Do not modify the folder name or file path where the firmware is stored, otherwise the upgrade may fail.
- Before upgrading, make sure that at least one of the following conditions is met:
 - PV input voltage is higher than 150 V (it is recommended to perform the upgrade on a sunny day);
 - Battery state of charge (SOC) is higher than 20%;
 - Battery input voltage is higher than 150 V.

Failure to meet any of these conditions may result in an unsuccessful upgrade.

Upgrade Failure Handling

⚠ CAUTION

- If the ARM firmware upgrade fails or is interrupted, do not remove the USB device. Turn off the inverter, restart it, and then repeat the upgrade procedure.
- If the DSP firmware upgrade fails or is interrupted, troubleshoot as follows:
 - Check whether the PV switch is turned off. If it is, turn it back on.
 - (Recommended) If the PV switch is already on, verify that the battery and PV parameters meet the upgrade requirements (PV or battery input voltage above 150 V, or battery SOC above 20%).
- If the LCD screen freezes or becomes unresponsive after the upgrade, turn off the PV switch and restart the inverter.
- Check whether the inverter resumes normal operation. If it still cannot recover, please contact after-sales service.

7.4 Removing the Inverter

⚠ DANGER

Before removing the inverter, make sure all power sources are completely disconnected to avoid electric shock or short circuit.

This procedure must be performed by a qualified electrician.

Operating Procedures

Step 1: Power off the system

- Follow the steps described in 7.1 Power OFF the Inverter to ensure complete power disconnection.
- Verify that all indicator lights are off.

Step 2: Disconnect the cables

- Use a screwdriver to remove the PV connection cables.
- Carefully disconnect the battery and communication cables.
- Loosen and remove the AC input and output cables.
- Label each cable for easy reinstallation.

Step 3: Remove the inverter

- Hold the bottom of the inverter firmly with both hands, and use a Phillips screwdriver to remove the two mounting screws on the top and two on the bottom.
- Carefully lift and remove the inverter from the mounting bracket.

Step 4: Packaging and storage

- Repack the inverter using its original packaging materials if available.
- Store the device in a dry, ventilated, and dust-free environment.
- Do not place heavy objects on top of the inverter to prevent deformation or damage.

7.5 Troubleshooting

7.5.1 Fault on the LCD

If the dot on the left of fault item is red, it means the fault is active. When it is grey, it means the fault is defective.

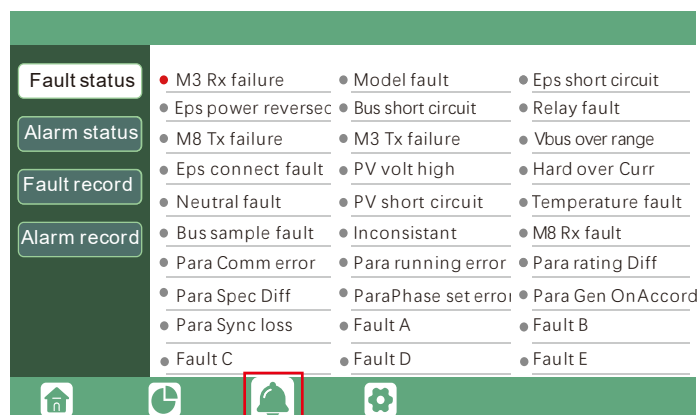

7.5.2 Fault Message & Troubleshooting are given below:

Fault	Meaning	Troubleshooting
M3 Rx failure	M3 microprocessor fails to receive data from DSP	Restart inverter, if the error still exists, contact your supplier.
Model fault	Incorrect model value	
EPS short circuit	Inverter detected short-circuit on EPS Load output terminals	1. Check if the R, S,T and N wires are connected correctly at inverter EPS Load output port; 2. Disconnect the EPS Load breaker to see if fault remains. If fault persists, contact your supplier.
EPS power reversed	Inverter detected power flowing into EPS Load port	Restart inverter, if the error still exists, contact your supplier.
Bus short circuit	DC Bus is short circuited	
Relay fault	Relay abnormal	
M8 Tx failure	DSP fails to receive data from M8 microprocessor	
M3 Tx failure	DSP fails to receive data from M3 microprocessor	Please check if the PV string voltage is within the inverter specification. If string voltage is within range, and this fault still appears, contact your supplier.
Vbus over range	DC Bus voltage too high	
EPS connect fault	EPS Load port and grid port are connected mixed up	Check if the wires on EPS Load port and grid port are connected correctly. If the error exists, contact your supplier.
PV volt high	PV voltage is too high	Please check if the PV string voltage is within the inverter specification. If string voltage is within range, and this fault still appears, contact your supplier.

Hard over current	Hardware level overcurrent protection triggered	Restart inverter, if the error still exists, contact your supplier.
Neutral fault	Voltage between N and PE is greater than 30V	Check if the neutral wire is connected correctly.
PV short circuit	Short circuit detected on PV input	Disconnect all PV strings from the inverter. If the error persists, contact your supplier.
Temperature fault	Heat sink temperature too high	Install the inverter in a place with good ventilation and having no direct sunlight. If the installation site is okay, please check if the NTC connector inside the inverter is loose.
Bus sample fault	Inverter detected DC bus voltage lower than PV input voltage	Restart inverter, if the error still exists, contact your supplier.
Inconsistent	Sampled grid voltage values of DSP and M8 microprocessor are inconsistent	
M8 Rx fault	M8 microprocessor fails to receive data from DSP	
Para Comm error	Parallel communication abnormal	<ol style="list-style-type: none"> 1. Please check whether the connection of the parallel cable is loose, please connect the parallel cable correctly 2. Please check and make sure the PIN status of CAN communication cable from the first to the end inverter rightly
Para primary loss	No primary in the parallel system	<ol style="list-style-type: none"> 1. If a primary has been configured in the system, the fault will be automatically removed after the primary works. If so, you can ignore it. 2. If a primary has not been configured in the system, and there are only subordinate in the system, please set the primary first.
Para rating Diff	Rated power of parallel inverters are inconsistent	Please confirm that the rated power of all inverters are the same, or you can contact service to confirm

Para Phase set error	Incorrctet setting of phase in parallel	Please confirm that the wiring of the parallel system is correct first. In this case, then connect each inverter to the grid, the system will automatically detect the phase sequence, and the fault will be automatically resolved after the phase sequence is detected.
Para sync loss	Inconsistent generator connect in parallel	Some inverters are connected to generators, some are not. Please confirm that all inverters in parallel are connected to generators together or none of them are connected to generators
Para Gen un Accord	Parallel inverter fault	Restart inverter, if the error still exists, contact your supplier.

7.5.3 Alarm on the LCD

If the dot on the left of fault item is yellow, it means the fault is active. When it is grey, it means the fault is defective.

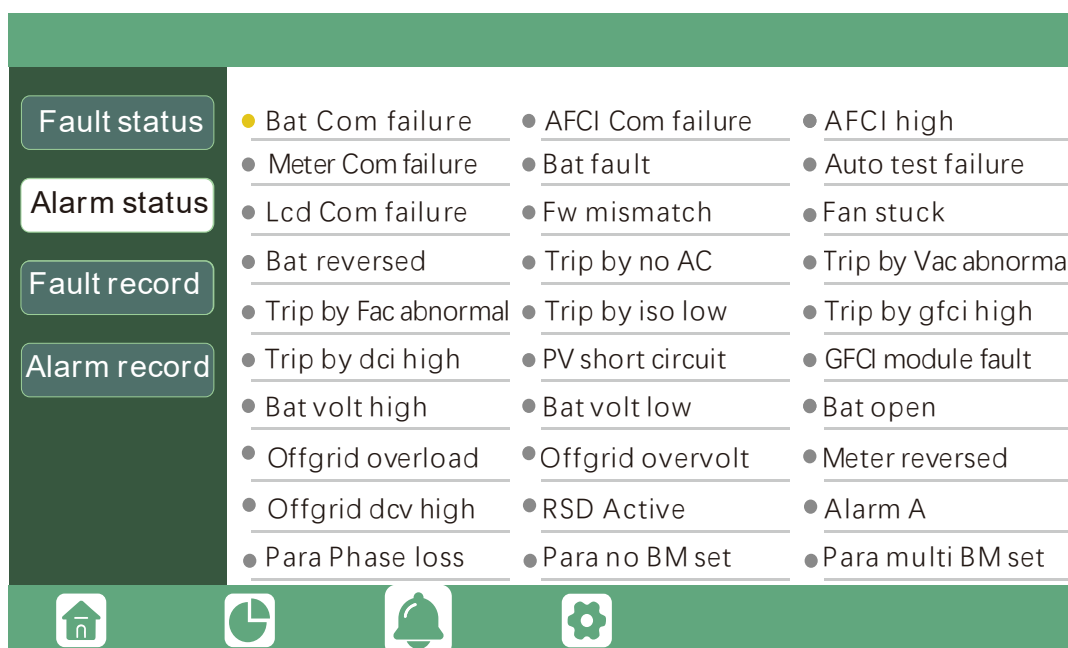

7.5.4 Alarm Message & Troubleshooting are given below:

Alarm	Meaning	Troubleshooting
Bat com failure	Inverter fails to communicate with battery	Check if communication cable is correct, and if you have chosen the correct battery brand on inverter LCD. If all is correct but this error persists, please contact your supplier.
AFCI com failure	Inverter fails to communicate with AFCI module	Restart inverter, if the error persists, contact your supplier.
AFCI high	PV arc fault is detected	Check each PV string for correct open circuit voltage and short circuit current. If the PV strings are in good condition, please clear the fault on inverter LCD.
Meter com failure	Inverter fails to communicate with the meter	1. Check if the communication cable is connected correctly and in good condition. 2. Restart inverter. If the fault persists, contact your supplier.
Bat Fault	Battery cannot charge or discharge	1. Check the battery communication cable for correct pinout on both inverter and battery end; 2. Check if you have chosen an incorrect battery brand; 3. Check if there is fault on battery's indicator. If there is fault, please contact your battery supplier.
Auto test failure	Auto test failed	Only applied to Italy model.
LCD com failure	LCD fails to communicate with M3 microprocessors	Restart inverter. If fault still exists, please contact your supplier.
Fwm mismatch	Firmware version mismatch between the microprocessors	
Fan stuck	Cooling fan(s) are stuck	
Trip by gfci high	Inverter detected leakage current on AC side	1. Check if there is ground fault on grid and load side; 2. Restart inverter. If the fault remains, contact your supplier.

Trip by dci high	Inverter detected high DC injection current on grid port	Restart inverter. If the fault remains, contact your supplier.
PV short circuit	Inverter detected short circuited PV input	1. Check if each PV string is connected correctly; 2. Restart inverter. If the fault remains, contact your supplier.
GFCI module fault	GFCI module is abnormal	Restart inverter. If fault still exists, contact your supplier.
Bat volt high	Battery voltage too high	Check if battery voltage exceeds 59.9V, battery voltage should be within inverter specification.
Bat volt low	Battery voltage too low	Check if battery voltage is under 40V, battery voltage should be within inverter specification.
Bat open	Battery is disconnected from inverter	Check battery breaker or battery fuse.
Offgrid overload	Overload on EPS port	Check if load power on inverter EPS port is within inverter specification.
Offgrid overvolt	EPS voltage is too high	Restart inverter. If fault still exists, contact your supplier.
Meter reversed	Meter is connected reversely	Check if meter communication cable is connected correctly on inverter and meter side.
Offgrid dcv high	High DC voltage component on EPS output when running off-grid	Restart inverter. If fault still exists, contact your supplier.
Para no BM set	Primary isn't set in the parallel system	Please set one of the inverters in the parallel system as the primary
Para multi BM set	Multiple Primary have been set in the parallel system	There are at least two inverters set as Primary in the parallel system, please keep one Primary and the other set as Subordinate.

7.7 Replacement of the Fan

Please inspect and clean the inverter's cooling fans regularly — a recommended interval is every 6 months. If any fan is found to be malfunctioning or damaged, please follow the steps below for replacement.

⚠ CAUTION

- Before disassembling the equipment, turn off the system power and wait at least 5 minutes to ensure that the internal high-voltage capacitors have fully discharged.
- When replacing the fan, always use insulated tools and wear appropriate personal protective equipment (PPE).

Operating Procedures

Step 1. Loosen the mounting screws and remove the fan cover plate (or fan assembly).

Step 2. Disconnect the fan cable connector, fully pull out the fan bracket (or fan assembly) , remove the faulty fan, and install the new one.

Step 3. After installation, reassemble the components in the reverse order of disassembly.

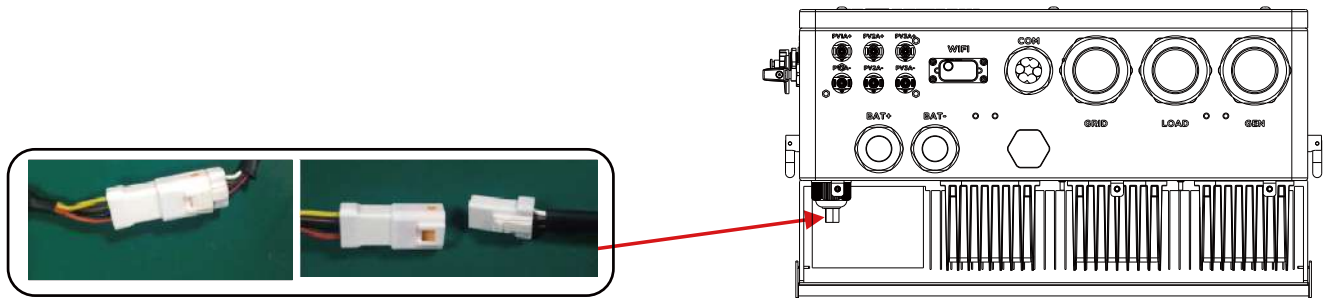
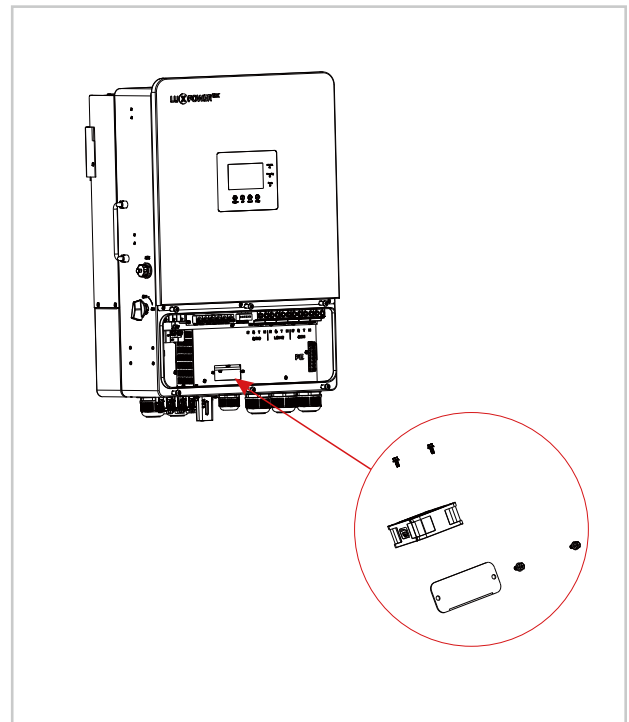
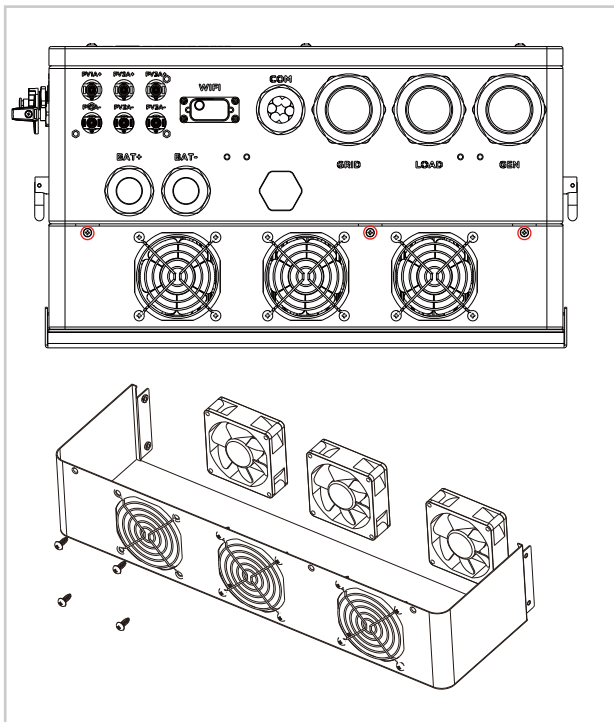

9. Specifications

Model number	TriP2-LB-3P 5K	TriP2-LB-3P 6K	TriP2-LB-3P 8K	TriP2-LB-3P 10K	TriP2-LB-3P 12K	TriP2-LB-3P 15K	TriP2-LB-3P 20K
Max. input power(W)	7500	9000	12000	15000	18000	22500	30000
Max. input voltage(V)	1000						
MPPT voltage range(V)	200-900						
Start voltage(V)	100						
Nominal input voltage(V)	690						
Max. input current per MPP tracker(A)	20						
Max. short-circuit current per MPP tracker(A)	25						
No. of MPP trackers	3						
No. of PV strings per MPP tracker	1						
Battery Input Data							
Battery type	Lithium-ion/Lead-acid						
Communication interface	CAN/RS485						
Battery voltage range(V)	40-60						
Max. Charge/Discharge Current(A)	125	150	200	220	250	250	250
Max. Charge/Discharge Power(W)	5000	6000	8000	10000	12000	12000	12000
AC Grid output data							
Max. AC active power(W)	5000	6000	8000	10000	12000	15000	20000
Nominal AC apparent power(VA)	5000	6000	8000	10000	12000	15000	20000
Nominal AC voltage(V)	3L/N/PE, 230/400Vac						

AC grid frequency(Hz)	50Hz						
Max. output current(A)	7.2	8.7	11.6	14.5	17.4	21.7	29
Adjustable power factor	0.8leading...0.8lagging						
THDI	≤3%						
Off-grid output Data							
Nominal output apparent power(VA)	5000	6000	8000	10000	12000	15000 (PV+Battery)	20000 (PV+Battery)
Nominal output voltage(V)	3L/N/PE, 230/400Vac						
Nominal output current(A)	7.2	8.7	11.6	14.5	17.4	21.7	29
Output Voltage Frequency(Hz)	50Hz						
THDV(@ Linear Load)	≤3%						
Switching time	≤10ms						
Peak power/Duration	7500/ 5min	9000/ 5min	12000/ 5min	15000/ 5min	18000/ 5min	22000/ 5min	30000/ 5min
Efficiency							
Max. efficiency	97%						
Max. Charge/Discharge efficiency	96%						
Protection Devices							
DC switch	YES						
Insulation resistance monitoring	YES						
DC reverse polarity protection	YES						
AC/DC surge protection	YES						

AC/DC surge protection	YES
Anti-islanding protection	YES
AC over current protection	YES
AC over voltage protection	YES
General Data	
Operating temperature range(°C)	-25 °C ~ +60 °C
Altitude(m)	4000m
Cooling concept	Smart cooling
Topology	Transformer-less
Meter Communication	RS485
Monitoring	WiFi+2G/4G(Optional)
Degree of protection	IP66
Installation	Wall mounting
Dimensions(W/H/D) mm)	480*703*259.5mm
Weight(Kg)	53kg
DC terminal	MC4
AC terminal	Cabel glands + terminal
Parallel	YES
Warranty	5 years/10 years

■ YOUR RELIABLE ENERGY SOLUTION PARTNER



Lux Power Technology Co., Ltd
Headquarter: +86 755 8520 9056
www.luxpowertek.com
Contact us: info@luxpowertek.com



092.20113AA