

PowerBrick PLUS

USER MANUAL

Battery Module
51.2V/314Ah

Contents

Statement of Law.....	1
Revision History.....	1
Safety Precautions.....	2
Manual Declaration.....	4
Safety Statement.....	4
Sign explanation.....	4
1 Introduction.....	5
Brief Introduction.....	5
Product Properties.....	5
Product Identity Definition.....	6
2 Product Specification.....	7
Size and Weight.....	7
Performance Parameter.....	7
Interface Definition.....	7
Battery Management System(BMS).....	9
3 Installation and Configuration.....	11
Preparations for Installation.....	11
Equipment Installation.....	16
4 Use, Maintenance and Troubleshooting.....	32
Battery System Usage and Operation Instructions.....	32
Alarm Description and Processing.....	33
Analysis and Treatment of Common Faults.....	34

Statement of Law

Copyright of this document belongs to Dyness Digital Energy Technology Co., LTD..

No part of this documentation maybe excerpted, reproduced, translated, annotated or duplicated in any form or by any means without the prior written permission of Dyness Digital Energy Technology Co., LTD..

This product complies with the design requirements of environmental protection and personal safety. The storage, use and disposal of the products shall be carried out in accordance with the product manual, relevant contract or relevant laws and regulations. Customer can check the related information on the website of Dyness Digital Energy Technology Co., LTD. .When the product or technology is updated.

Please note that the product can be modified without prior notification.

Revision History

Revision NO.	Revision Date	Revision Reason
V0	2025.11.19	First Published

Safety Precautions



WARNING

Please do not put the battery into water or fire, in case of explosion or any other situation that might endanger your life.

Please connect wires properly while installation, do not reverse connect.

To avoid short circuit, please do not connect positive and negative poles with conductor on the same device.

Please avoid any form of damage to battery, especially stab, hit, trample or strike.

Please shut off the power completely when removing the device or reconnecting wires during the daily use or it could cause the danger of electric shock.

Please use dry powder extinguisher to put out the flame when encountering a fire hazard, liquid extinguisher could result in the risk of explosion.

For your safety, please do not arbitrarily dismantle any component in any circumstances. The maintenance must be implemented by authorized technical personnel or our company's technical support. Device breakdown due to unauthorized operation will not be covered under warranty.

**CAUTION**

Our product have been strictly inspected before shipment. Please contact us if you find any abnormal phenomena such as device outer case bulging.

The product shall be grounded properly before use In order to ensure your safety.

To assure the proper use please make sure parameters among the relevant device are compatible and matched.

Please do not mixed-use batteries from different manufacturers, different types and models, as well as old and new together.

Ambient and storage method could impact the product life span, please comply with the operation environment instruction to ensure device works in proper condition.

For long-term storage, the battery should be recharged once every 6 months, and the amount of electric charge shall exceed 80% of the rated capacity.

Please charge the battery in 18 hours after it fully discharged or over-discharging protection mode is activated.

Formula of theoretical standby time: $T=C/I$ (T is standby time, C is battery capacity, I is total current of all loads).

The surface of the product cabinet is affixed with a torn invalid label. Therefore, before opening the cover , you need to contact DYNESS and inform the product ID. DYNESS will record this battery ID and authorize the opening operation to be performed. Except for changing the DIP switch mode, no other operations are allowed. In the next stage, you can log in to apply for operations directly on the DYNESS website. Contact the authorized dealer or distributor of DYNESS for a new torn invalid sticker after tearing the original invalid label. When the operation is completed, paste the new one at a different position.

Preface

Manual Declaration

PowerBrick PLUS Lithium Iron Phosphate Battery is external battery module which can store the electricity for home use. When you apply the grid or photovoltaic system as your powers supply, the product can collect electricity to charges the battery. When grid or photovoltaic system is power off , the product can supply electricity itself for your home loads.

PowerBrick PLUS User manual systematically elaborates device structure, parameters, basic procedure and method of installation, operation, maintenance.

Safety Statement

Only qualified trained professionals are allowed to install, operate, maintain the device.

Please comply with local safety regulations and operational rules during installation, operation and maintenance, or it could cause unexpected injury or device damage.

The safety declaration mentioned in the manual are only supplement context for your local safety regulations.

The seller does not undertake any responsibility for device operations or usage of violating general safety requirements and safety standards.

Sign explanation

User should clear the meaning of the caution sign below when configuring or operating PowerBrick PLUS series products.



CAUTION

Neglecting the warnings might cause equipment failure.

1 Introduction

Brief Introduction

PowerBrick PLUS series is equipped with lithium iron phosphate battery for family use . We base on customer needs and market requirement to develop cutting-edge battery storage technology and offer this high quality product to supply stable electricity for all kind of user's devices. The product have long life span and can be applied in high temperature environment and take less space for installation.

PowerBrick PLUS series carries self-developed battery management system. When you apply the grid or photovoltaic system as your powers supply, the product can collect electricity to charges the battery. When grid or photovoltaic system is power off , the product can supply electricity itself for your home loads. Products also can be paralleled to build a multi-module system with more capacity to satisfy the longtime energy storage demand.

Product Properties

PowerBrick PLUS series energy storage product's anode materials are lithium iron phosphate, battery cells are managed effectively by BMS with better performance, the systems features as below:

- Comply with European ROHS, Certified SGS, employ non-toxic, non-pollution environment-friendly battery.
- Anode materials are lithium iron phosphate (LiFePO₄), high safety performance with longer life span.
- Equipped with BMS (battery management system) mode with better performance, possess protection function like over-discharge, over-charge, over-current, abnormal temperature.
- Self-management on charging and discharging, Single core balancing function.
- Intelligent design configures integrated inspection module.
- Flexible configurations allow parallel of multi battery for longer standby time.
- Less battery self-discharge, recharging period can be up to 10 months during the storage.
- No memory effect so that battery can be charged and discharged shallowly.

- With wide range of temperature for working environment, -20°C ~ +55°C, circulation span and discharging performance are well under high temperature.
- Less volume, lighter weight, embedding design for easier installation and maintenance.

Product Identity Definition

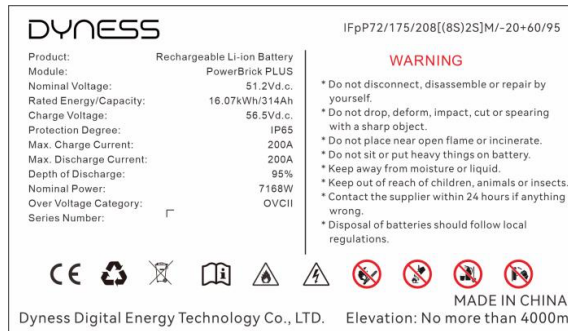







Figure 1-1 Battery Module Label



Figure 1-2 Heating function Label

(Only systems with heating function will be labeled with this label)

Table 1-1 Symbol Definition

	Battery voltage is higher than safe voltage, direct contact with electric shock hazard.
	Be careful with your actions and be aware of the dangers.
	Read the user manual before using.
	The scrapped battery cannot be put into the garbage can and must be professionally recycled.
	After the battery life is terminated, the battery can continue to be used after it recycled by the professional recycling organization and do not discard it at will.



inflammable.



Do not place near open flame or incinerate.



If catch fire, do not put out with water.



If catch fire, do not put out with dry powder fire extinguisher.



Do not cut or spear with sharp objects.

2 Product Specification

Size and Weight

Table 2-1 PowerBrick PLUS Series Device Model

Product Series	Nominal Voltage	Nominal Capacity	Dimension (mm)	Weight (kg)	Protection level
PowerBrick PLUS	51.2Vd.c.	314Ah	435*233*850	117	IP65

Performance Parameter

Table 2-2 PowerBrick PLUS performance parameter

Item	PowerBrick PLUS
Nominal Voltage(V)	51.2
Work Voltage Range(V)	44.8~57.6
Nominal Capacity(Ah)	314
Nominal Energy(kWh)	16.07
Recommended Charge/Discharge Current (A)	140
Max Power Continuous Charge Current (A)	200
Max Power Continuous Discharge Current (A)	200
Recommend Charge Voltage (V)	56.5

Interface Definition

This section elaborates on interface functions of the front panel of the device.

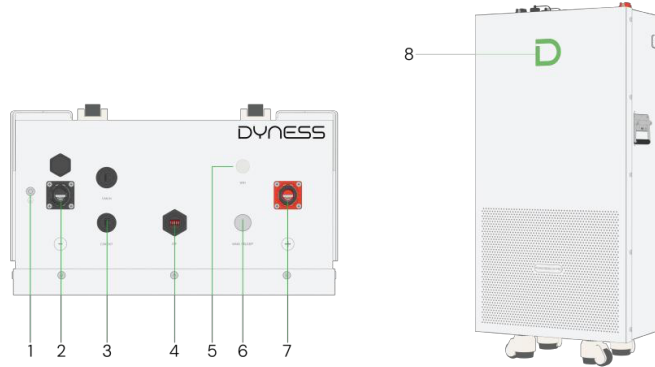

Figure 2-1 PowerBrick PLUS the Sketch of Front Interface

Table 2-3 Interface Definition

Item	Name	Definition
1	Grounding	Shell ground connection
2	Negative socket	Battery output or parallel cathode line
3	CAN/485	Communication Port Communication (factory default CAN communication)
4	ADD	DIP switch
5	Wifi	Remote upgrade program
6	WAKE/SLEEP	When power switch is in 'ON', long pressing the button for 3s to enable the battery for switch-on or dormant state
7	Positive socket	Battery output or parallel anode line
8	LED light	Display battery SOC and warning information

Table 2-4 LED Status Indicators

LED status	Information
	SOC 50%
	SOC 100%
Current SOC increases to 100% ,then cycles 	Charge
Drop from current SOC to 0%, then loop 	Discharge
Green light flashing(Current SOC) 	Standby
Yellow light flashing 	Communication failure between batteries or communication failure between lamp board and BMS
Red light on 	System protection

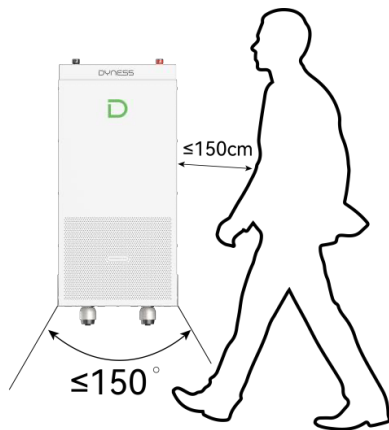

Figure 2-2 Light on condition

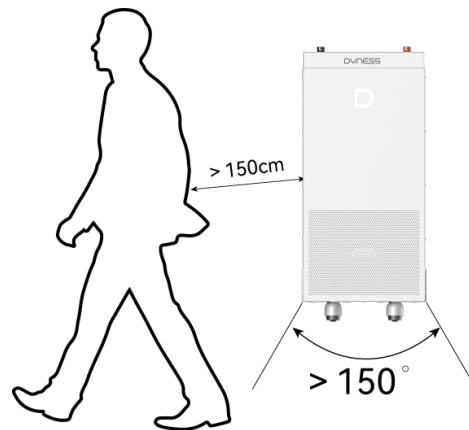

Figure 2-3 light off condition

After the battery is turned on, its initial state is the induction state. Any moving metal object or person that meets the two conditions of being within a distance of 150 cm and an angle of 150° can trigger the induction light to turn on(Figure 2-2).To switch to the always-on state for the first time, press the SW button twice

in quick succession. Subsequent switching between the induction state and the always-on state can be achieved by pressing the SW button once.

Battery Management System(BMS)

Voltage Protection

Low Voltage Protection in Discharging:

When any battery cell voltage or total voltage is lower than the rated protection value during discharging, the over-discharging protection is activated, and the battery buzzer makes an alarm sound. Then battery system stops supplying power to the outside. When the voltage of each cell back to rated return range, the protection is over.

Over Voltage Protection in Charging:

During charging stage, the system will stop charging when the total voltage of the battery pack is higher than rated value or the voltage of any single cell reaches the protection value. When total voltage or all cell back to rated range, the protection is over.

Current Protection

Over Current Protection in Charging:

When the charge current of any module $>210A$, current limit protection mode is activated, current will be limited to $\leq 5A$, protection is removed after rated time delaying 10secs. Circulate like this until the current is lower than 210A.

Over Current Protection in Discharging:

When the discharge current of any module is higher than 305A, the battery buzzer alarms and the system stops discharging at once. After protection, the discharging will restore in 60secs delay or immediately when there is charging current.



CAUTION

The buzzer sound alarm setting can be manually turned off on the background software, and the factory default is on.

Temperature Protection

Low/Over temperature protection in charging:

When battery's temperature is beyond range of $0^{\circ}C \sim +55^{\circ}C$ during charging, temperature protection be activated, device stops charging. The protection is released when it back to rated range of working temperature.

Low/Over temperature protection in discharging:

When battery's temperature is beyond range of $-20^{\circ}\text{C} \sim +55^{\circ}\text{C}$ during discharging, temperature protection be activated, device stops supplying power to the outside. The protection is released when it back to rated range of working temperature.

Other Protection

Short Circuit Protection:

When the battery is activated from the off state, if a short circuit occurs, BMS will be activated automatically and cut off the device's output.

Self Shutdown:

When device connects no external loads for over 72 hours, device will dormant standby automatically.



CAUTION

The maximum operating current required for the electrical load shall be less than the maximum discharge current capacity of the battery.

3 Installation and Configuration

Preparations for Installation

Safety Requirement

This system can only be installed by personnel who have been trained in the power-supply system and have sufficient knowledge of the power system.

The safety regulations and local safety regulations listed below should always be followed during the installation.

- All circuits connected to this power system with an external voltage of less than 48V must meet the SELV requirements defined in the IEC60950 standard.
- If operating within the power system cabinet, make sure the power system is not charged. Battery devices should also be switched off.
- Distribution cable wiring should be reasonable and has the protective measures to avoid touching these cables while operating power equipment.

The following protective items must be worn when installing the battery system:



Figure 3-1 Safety Gear

Environmental requirements

Charging temperature range is 0°C~+55°C (Products without heating function)

Charging temperature range is -20°C~+55°C (Products with heating function)

Discharging temperature range is -20°C~+55°C

Storage temperature: -10°C~+35°C

Relative humidity: 5% ~ 85%RH

Elevation: no more than 4000m

Operating environment: Indoor or outdoor installation, sites avoid the sunlight and no wind and rain, no conductive dust and corrosive gas.

And the following conditions are met:

- Installation location should be away from the sea to avoid brine and high humidity environment.
- The ground for product arrangement shall be flat and level.
- There is no flammable explosive materials near to the installation site.
- The optimal ambient temperature is 15°C~30°C.
- Keep away from dust and messy zones.

Installation location precautions

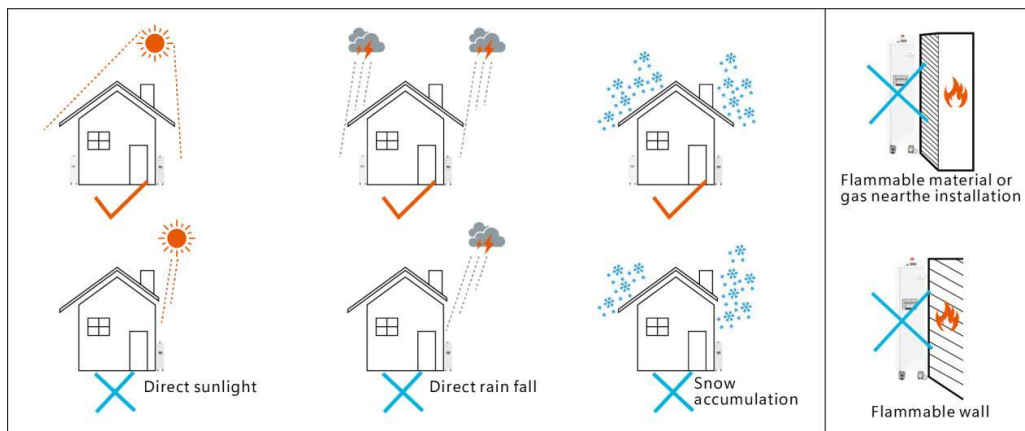

Tools and data

Tools and meters that may be used are shown in Figure 3-2 Installation Tools.



Figure 3-2 Installation Tools

Technical Preparation

Electrical interface check

Devices that can be connected directly to the battery can be user equipment, power supplies, or other power supplies.

Confirm whether the user equipment, the PV equipment or other power supply equipment has the DC output interface, and measure whether the output voltage of the standby interface meets the requirements of the voltage range of table 2-2.

Verify that the maximum discharge current capacity of the user equipment, the PV equipment or other power supplies, the DC standby interface, and the maximum discharge current shall be greater than the maximum charging current of the products used in table 2-2.

If the user equipment DC prepared interface maximum discharge current capacity is less than the maximum charging current of table 2-2, the user interface should have the power equipment of DC current limiting function, give priority to ensuring the normal work of user equipment.

The security check

Firefighting equipment should be arranged near the equipment, such as portable dry powder fire extinguisher.

Automatic fire fighting system shall be provided for the case where necessary.

Flammable, explosive and other dangerous materials placed beside the battery are prohibited.

Unpacking Inspection











When the equipment arrives at the installation site, loading and unloading should be carried out according to the rules and regulations, so as to prevent from being exposed to sun and rain.





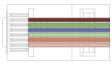

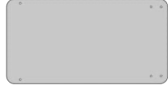
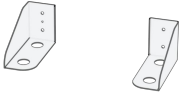
Before unpacking, the total number of packages shall be indicated according to the shipping list attached to each package, and the case shall be checked for good condition.

In the process of unpacking, handle with care and protect the surface coating of the object.

Open the package, the professional installation personnel should read the technical documents, verify the list, according to the configuration table and packing list, ensure objects are complete and intact. If the internal packaging is damaged, it must be inspected and recorded in detail.

Table3-1 Packing list

Item	Specification	Quantity	Figure
Battery	51.2V/314Ah	1	
Power cable- positive	Red/50mm ² /L2050m	1	
Power cable- negative	Black/50mm ² /L2050mm	1	
Communication cable-to inverter	Black/L2000mm /Double RJ45 plug	1	
Communication parallel cable	Black/L2000mm /Double RJ45 plug	1	
Ground wire	L500mm,6mm ²	1	
CAN resistor	120Ω	1	
Screw	Cross Recessed Pan Head three combination M6*14	3	
Expansion Bolt	M6*80	6	
Positioning cardboard	/	1	
Battery bracket	SGCC	1pair	
Fixing bracket	SGCC	2	

Unlock Piece-BLACK	/	1	
User Manual	User Manual	1	
Letter to customer	/	1	
Warranty card	/	1	
Packing list	/	1	
Top cover (Optional)	SGCC	1	
Regulating wheel(Optional)	GD40S	4	

Engineering Coordination

- Attention should be paid to the following items before construction:
- Power cable specification.
- The power cable specification shall meet the requirements of maximum discharge current for each product.
- Mounting space and bearing capacity.
- Make sure that the battery has enough space to install, and that the battery rack and bracket have enough load capacity.
- Wiring.
- Make sure the power cable and ground wire are reasonable. Not easy to short-circuit, water and corrosion.

Equipment Installation

The wall for battery installation shall be solid brick or cement wall with strong bearing capacity and wall thickness no less than 100mm. The distance between the left and right sides of the battery is greater than 300mm.

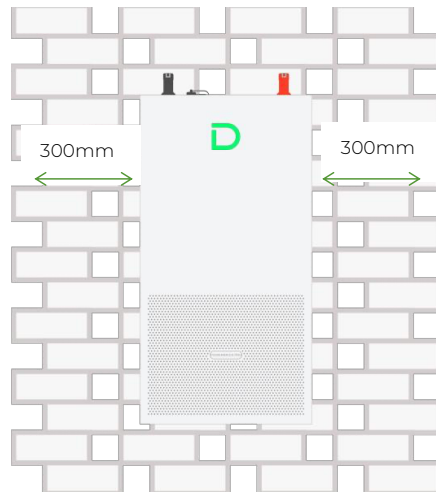
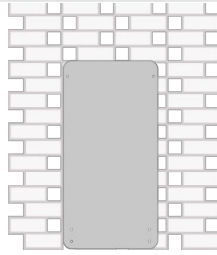

Figure 3-3 Mounting Space Requirements

Table 3-2 Installation steps

Step 1 System outage
Ensure that the battery is in a shutdown state
Step 2 Mechanical installation
1. Hanger mounting
2. Equipment installation
Step 3 Electrical installation
1. Connect the ground cable
2. Electrical installation
3. Connect inverter
4. Communication interface connection
Floor Installation
When the battery system is placed directly on the ground, a fixed support must be used to fix the top of the battery box on the wall.
1. Use the positioning cardboard (provided in accessory package) and mark the screw hole positions on the wall, as shown in the four holes on the left.



2. The bottom of board must be good connection with the ground level while marking the holes.
3. Press the marked position with the electric drill and trepanning 2 holes with a diameter of 10mm on the wall. The hole depth shall be greater than 70mm for fitting the expansion bolt of M6.
4. Fixing the expansion bolt M6 into the bottom of the hole on the wall.

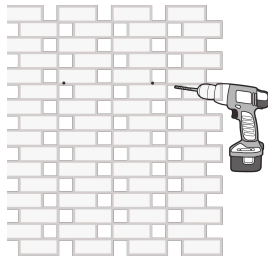

5. Use the M6 bolt to fixing the Support bracket to the wall and control the torque at 6NM.

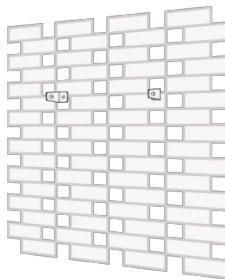

6. Carry the battery box to the installation site, and place it about 15mm away from the wall surface, fixing the Support bracket and the upper part of the battery box with M6 bolts.



Mounted on the wall

The following accessories need to be added when install the PowerBrick PLUS on the wall.

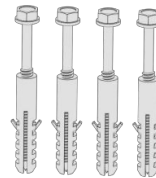

Battery Bottom Bracket ×1

Expansion Screw ×4

1. Use the positioning cardboard (provided in accessory package) and mark the screw hole positions on the wall, as shown in the four holes on the left.

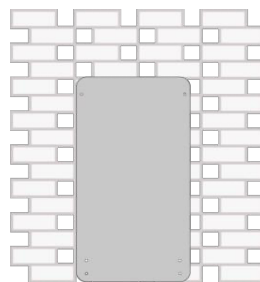

2. The cardboard must be perpendicular to the ground while drawing the holes.
3. The bottom of the cardboard is about 300mm from the ground.
4. According to the position of the mark, 6 holes in diameter 10mm and depth of more than 70mm are hit on the wall with an electric drill, which are used for fitting expansion bolt M6.

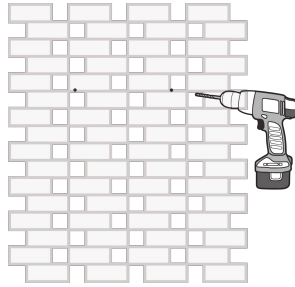

5. Fixing the expansion bolt M6 into the bottom of the hole on the wall, and fix the Support bracket and Battery bottom bracket on the wall with M6 bolts, twisting force keeps 6NM.

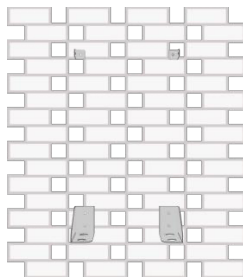

6. Carry or hoist the battery box to the installed Battery bottom bracket. Fixing the Support bracket and the upper part of the battery box with M6 bolts, twisting force keeps 6NM. Then fixing the Battery bottom bracket and the bottom part of the battery box with M6 bolts, twisting force keeps 6NM. The boss at the bottom of the chassis needs to be aligned with the carrier holes.



Wheel installation

1. Take out the wheel from the accessory box.
2. Align the screw of the wheel with the installation threaded hole at the bottom of the product.
3. Use a wrench to tighten the wheels and transport the battery vertically.

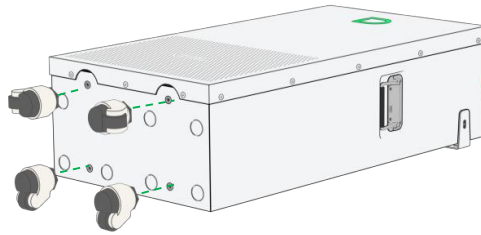

CAUTION

This is an optional configuration. Please check if the model you purchased includes wheels.



CAUTION

Installing wheels is for easy movement. Please move the battery carefully and slowly to prevent it from tipping over.



CAUTION

After reaching the installation position, please refer to the Floor Installation or Mounted on the wall method to fix the battery.

Top cover installation

After successful electrical installation and debugging, install the top cover.



CAUTION

This is an optional configuration. Please check if the model you purchased includes wheels.



CAUTION

The top cover is fixed with a magnet and the chassis. Please pay attention to safety during installation and be careful not to pinch your fingers.

Electrical installation

Before connecting the power cables, using multimeter to measure cable continuity, short circuit, confirm positive and negative, and accurately mark the cable labels.

Measuring method:

Power cable check: Select the buzzer mode of multimeter and detect the both ends of the same color cable. If the buzzer calls, it means the cable is in good condition.

Short circuit judgment: Select the resistance range of the multimeter and probe at the same end of the positive and negative poles. If the resistance shows infinity, it indicates that the cable is not short circuited and can be used.

After visual testing of power line is connection, the positive and negative poles of the battery shall be connected respectively to the positive and negative poles of the opposite terminal.

1. Connect the battery box to the ground cable

Customer needs to prepare a M6 OT terminals and ground cables. Ground the battery shell as shown below. The sectional area of the grounding cable shall be at least 6mm² and the bolt locking torque is 6NM.

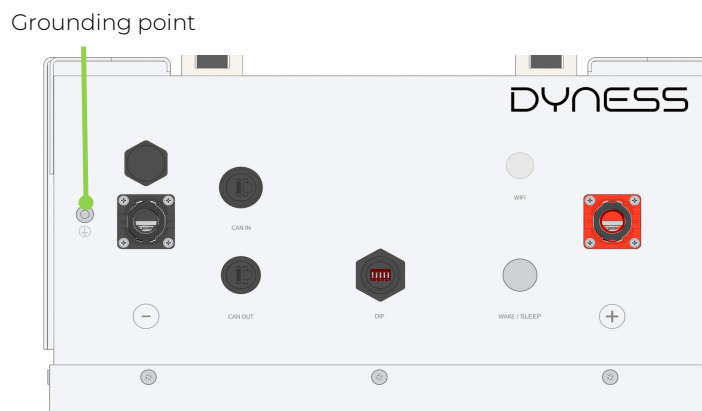

Figure 3-4 Location of grounding point



CAUTION

If there is any question during installation, please contact your dealer to avoid damage to the equipment.

2. Inverter Connection

When the system is used independently:

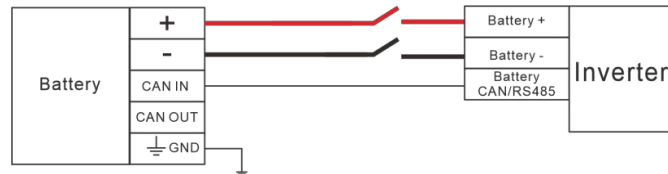

Figure 3-5 Wiring diagram

Before installation, please confirm whether the DIP switch mode of the battery is correct according to use's inverter communication specification.

For specific DIP operation methods, please refer to “ Battery module DIP switch definition and description.” Except for the inverter specified by the customer's special requirements, the factory default DIP switch mode of the battery is ADD: 0000. If the inverter is equipped with other DIP switch mode, Set DIP switch mode of the module to the correct mode.

The battery is connected to the inverter, and it is required to use the dedicated power cable and communication cable (as accessories shipped with the cargo, the standard communication cable is a standard network cable. The applicable inverter is marked on the label of the network cable. If the inverter used by the customer is not covered by the standard communication cable, please contact DYNESS for the correct PIN Sequence) as follows:

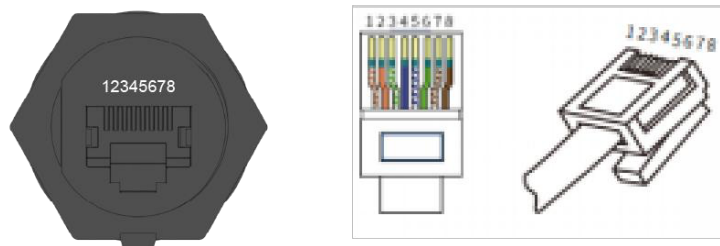

Table 3-3 CAN IN Pin Definition

Foot position	Color	Definition
PIN1	Orange/white	485B
PIN2	Orange	485A
PIN3	Green/white	Reserve
PIN4	Blue	EXT CANH
PIN5	Blue/white	EXT CANL
PIN6	Green	Reserve
PIN7	Brown/white	INT CANH
PIN8	Brown	INT CANL

Keep the battery system at power off state, connect the power cable to the interface on the input side of the inverter first, and then connect the power cable to the interface on the battery side. The power cable cross section is 35 mm².

Connection of Communication interface. Connect the CAN IN port of the battery to the CAN or RS485 communication interface of the inverter using the RJ45 cable.

Cable connection reference fig3-5 wiring diagram.

3. When the system used in parallel:

When the system is used in parallel, it supports up to 50 PowerBrick PLUS in parallel. According to the number of parallel system (Take 3 PowerBrick PLUS in parallel as an example), it needs to use: Power cable × 3 pair, Battery-Inverter communication cable × 1PCS, Battery-Battery communication cable × 2PCS, Distribution box × 1PCS. Cable connection reference fig3-6 wiring diagram.

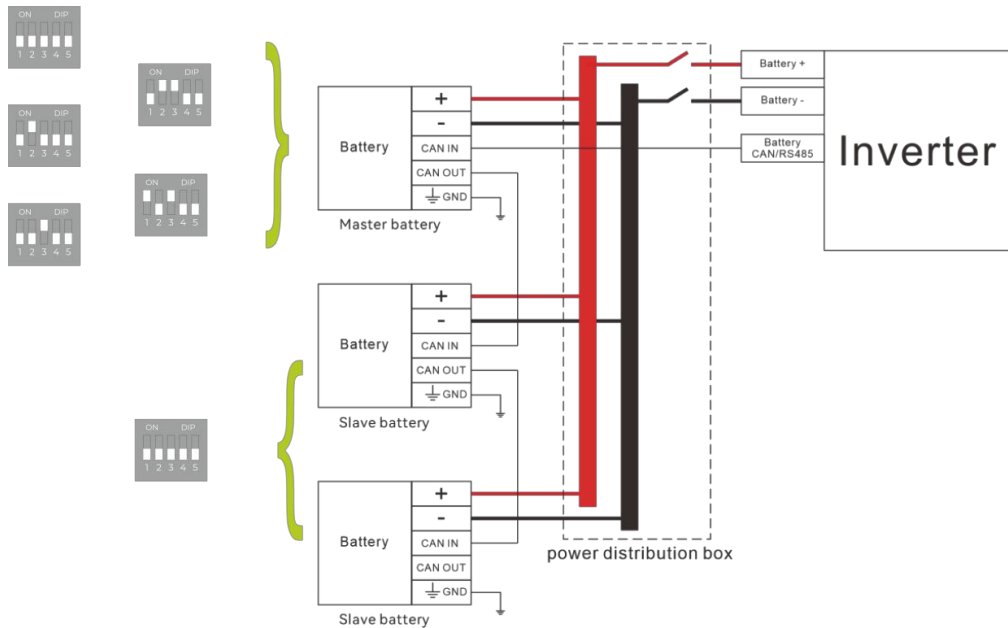

Figure 3-6 Wiring schematic diagram

The over-current capacity of the distribution box should be much higher than the maximum nominal current value when the load is running.

When the batteries are connected in parallel, the host communicates with the slaves through the CAN interface. The host summarizes the information of the entire battery system and communicates with the inverter through CAN or 485. If the master is the latest battery with DIP switch, For different inverter model, you need to set different DIP mode.



Please refer to Table 3-5 DIP Switch Description.

Battery Module DIP Switch Definition and Description

Table 3-4 DIP switch Definition

DIP switch position (master communication protocol and baud rate selection)					
#1	#2	#3	#4	#5	
					Baud rate selection /
					OFF: CAN: 500K,485: /
Define different protocols;					9600
					ON: CAN: 250K,485: /
					115200

Table 3-5 DIP Switch Description

DIP Switch Description
<p>1. When the battery works with Goodwe、Solis、TBB、SAJ、SOLAX,before starting the battery,you no need to change the DIP.Maintain factory mode 00000.</p> <div style="text-align: center;">  <p>Default Setting</p> </div>
<p>2. If the battery communicates with SMA、Victron、Ingeteam、Solplanet、SOFAR、Deye、Hoy miles、APsystems、LUXPOWER、MUST、SOSEN、Afore turn the master DIP switch "#3 "to"ON"position.</p> <div style="text-align: center;">  <p>Master Setting 1</p> </div>

3. If the battery communicates with the Axpert-king/VMIII/MAX, Infinisolar, Growatt SPH/SPA(CAN comm) , turn the master DIP switch "#2" to "ON".



Master Setting 2

4. If the battery communicates with the Growatt SPF HVM-P/ES/WPV by RS485 communication, turn the master DIP switch "#2" and "#3" to "ON".



Master Setting 3

5. If the battery communicates with the Schneider Conext Series, turn the master DIP switch "#1" and "#3" to "ON".



Master Setting 4

6. When you setup the master DIP as setting 1~4, all the slaves keep the DIP 0000,no need to change.

7. If the energy storage system has only one PowerBrick PLUS, it is the master itself, and still follow the above steps.

8. Note: For more information of matching inverter brands, please subject to the latest document <The list of compatibility between Dyness ESS and Inverters >.

**CAUTION**

When the battery works with Goodwe, Solis, TBB, SAJ (CAN Comm), SOLAX, before starting the battery, you no need to change the DIP. Maintain factory mode 0000.

**CAUTION**

When the number of parallel machines exceeds 12, CAN resistance needs to be added to the CAN OUT interface of the last battery. Refer to the following diagram.

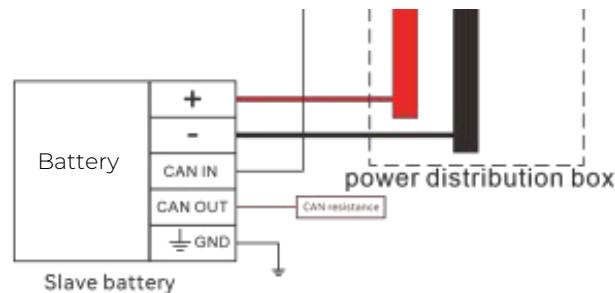
**CAUTION**

- Before connection, the positive and negative pole of the inverter input interface and the battery output interface should be confirmed.
- The red power line is connected to the positive pole and the black power line is connected to the negative pole.
- Before connection, it is necessary to confirm the charge and discharge parameters of the inverter interface.
- Voltage and current should meet the requirements of Table 2-2 battery performance parameters.
- Note: For more information of matching inverter brands, please subject to the latest document <The list of compatibility between Dyness ESS and Inverters >.
- How to judge that the communication between the product is normal:

- 1.If there is communication between the inverter and battery system, it can be judged by the maximum charge and discharge current value on the inverter sent by the battery.
(The maximum charge and discharge current value display on the inverter)/(The maximum charge and discharge current value of one battery module)=number of modules.
2. If the equation holds after calculation, it means communication between the PowerBrick PLUS is normal.
3. If the master battery LED flashes yellow, it means the communication between PowerBrick PLUS is fault.

Table 3-6 Battery & Inverter Power Matching Table

Power of Hybrid Inverter/ Off-grid Inverter	PowerBrick PLUS	
	Type	System Energy(kWh)
5KW	1*PowerBrick PLUS	16.076
10KW	1*PowerBrick PLUS	16.076
15KW	2*PowerBrick PLUS	32.152

Table 3-7 Battery usage recommendations

Equipment Use	Charging	<ol style="list-style-type: none"> 1. The battery's long-term continuous charging current should be $\leq 0.63C$ 2. If the battery remaining capacity is empty, please charge it within 48 hours after the battery is empty
	Discharging	<ol style="list-style-type: none"> 3. The long-term continuous discharge current of the battery should be $\leq 0.63C$ 4. The recommend maximum depth of discharge (DOD) of Battery PACK is no more than 95%

Battery Parameter Settings on the Inverter

Max Charging(Bulk) Voltage: 57.6V

Absorption Voltage: 56.5V

Float Voltage: 56V

Shut Down(cut off) Voltage: 48V

Shut Down(cut off) SOC: 5%

Restart Voltage: 52V

Max Charge Current: 200A

Max Discharge Current: 200A

4 Use, Maintenance and Troubleshooting

Battery System Usage and Operation Instructions

After completing the electrical installation, follow these steps to start the battery system.

Refer to DIP Switch Description to prepare the battery module before starting up.

Press and hold the wake/sleep button for 3 seconds.

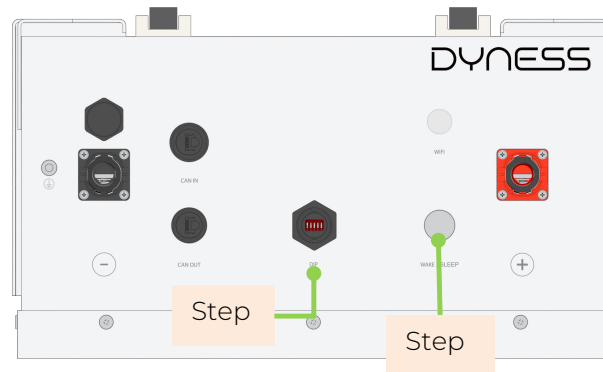

After the battery self-test, the green led lights will flash.



CAUTION

- After pressing the wake/sleep button, if the battery status indicator is steady red or blinking yellow, please refer to the "Alarm description and processing". If the failure cannot be eliminated, please contact the retailer timely.

1. Use a voltmeter to measure whether the voltage across the BAT + / BAT- terminals of the inverter is higher than 44.8V, and check whether the voltage polarity is consistent with the input polarity of the inverter. If the voltage across the terminals BAT + / BAT- of the inverter is higher than 44.8V, which means the battery has begun to work normally.
2. After confirm the battery output voltage and polarity are correct, turn on the inverter, then turn on the circuit breaker switch.
3. Check whether the indicator light for the inverter and the battery connection (the communication indicator and the battery access status indicator) is in normal condition. If normal, the connection between the battery and the inverter is completed. If the indicator light show abnormal, please check the inverter manual or contact the local dealer.

Alarm Description and Processing

When protection mode is activated or system failure occurred, the LED indicator on the front panel will alarm, through net management can query specific alarm class and take appropriate action.

If there are any abnormalities affecting the output, such as battery cell in the battery module occurs over-current protection during charge/discharge, under-voltage protection, and temperature protection, in the system, please deal with them according to Table 4-1.

Table 4-1 Main Protection

Statue	Alarm category	Protection indication	Processing
Charge state	Over-current protection when charge	RED light Always on Buzzer start	Stop charging and reduce charge current below rated value
	High temp protection when charge	RED light Always on	Stop charging and find out the cause of the trouble
Discharge state	Over-current protection when discharge	RED light Always on Buzzer start	Stop discharging and reduce discharge current below rated value
	High temp protection when discharge	RED light Always on	Stop discharging and find out the cause of the trouble
	Over-discharged protection	RED light Always on Buzzer start	Start charging

Analysis and Treatment of Common Faults

Table 4-2 Analysis and Treatment of Common Faults

Item	Fault phenomenon	Reason analysis	Solution
1	The indicator does not respond after power on the system	Make sure press and hold the wake/sleep button for 3s	Check the power switch
2	No DC output and red light is ON, buzzer beeping	Battery voltage is too low	Charging the battery system
3	The battery cannot be fully charged	Charging voltage is too low	Adjust charging voltage within 57.1V~57.6V range
4	The power cable sparks once power on and ALM indicated Red light on	Power connection short-circuit	Turn off the battery, check the cause of the short circuit
5	Master battery yellow light flashing	Abnormal communication between batteries	Check if the communication network cable connection between the batteries is correct
6	Battery yellow light flashing	Abnormal communication between battery motherboard and light board	Contact the dealer's after-sales engineer

If you need any technical help or have any question, please contact the dealer in time.

DYNNESS

Address: 5F, Building 2, Phase II of Rongxin Industrial Park, No. 56-58 Nanhu Road,
Chengnan Sub-district, Wuzhong District, Suzhou City, Jiangsu Province, China
Email: service@dyness-tech.com
Tel: +86 400 666 0655
Web: www.dyness.com



Official Website



Digital version access