

PowerHaus

USER MANUAL

Battery Module
51.2V/100Ah

Contents

Statement of Law	1
Revision History	1
Safety Precautions	2
Manual Declaration	4
Safety Statement	4
Sign Explanation	4
1 Introduction	5
Brief Introduction	5
Product Properties	5
Product Identity Definition	6
2 Product Specification	8
Size and Weight	8
Performance Parameter	8
Interface Definition	8
Battery Management System(BMS)	11
3 Installation and Configuration	13
Preparations for Installation	13
Equipment Installation	18
4 Use, Maintenance and Troubleshooting	28
Battery System Usage and Operation Instructions	28
Alarm Description and Processing	29
Analysis and Treatment of Common Faults	29

Statement of Law

Copyright of this document belongs to Dyness Digital Energy Technology Co., LTD.. No part of this documentation maybe excerpted, reproduced, translated, annotated or duplicated in any form or by any means without the prior written permission of Dyness Digital Energy Technology Co., LTD. This product complies with the design requirements of environmental protection and personal safety. The storage, use and disposal of the products shall be carried out in accordance with the product manual, relevant contract or relevant laws and regulations.

Customer can check the related information on the website of Dyness Digital Energy Technology Co., LTD. when the product or technology is updated.

Please note that the product can be modified without prior notification.

Revision History

Revision NO.	Revision Date	Revision Reason
V0	2025.04.24	First Published

Safety Precautions



WARNING

Please do not put the battery into water or fire, in case of explosion or any other situation that might endanger your life.

Please connect wires properly while installation, do not reverse connect.

To avoid short circuit, please do not connect positive and negative poles with conductor on the same device.

Please avoid any form of damage to battery, especially stab, hit, trample or strike.

Please shut off the power completely when removing the device or reconnecting wires during the daily use or it could cause the danger of electric shock.

Please use dry powder extinguisher to put out the flame when encountering a fire hazard, liquid extinguisher could result in the risk of explosion.

For your safety, please do not arbitrarily dismantle any component in any circumstances.

The maintenance must be implemented by authorized technical personnel or our company's technical support. Device breakdown due to unauthorized operation will not be covered under warranty.



CAUTION

Our product have been strictly inspected before shipment. Please contact us if you find any abnormal phenomena such as device outer case bulging.

The product shall be grounded properly before use In order to ensure your safety.

To assure the proper use please make sure parameters among the relevant device are compatible and matched.

Please do not mixed-use batteries from different manufacturers, different types and models, as well as old and new together.

Ambient and storage method could impact the product life span, please comply with the operation environment instruction to ensure device works in proper condition.

For long-term storage, the battery should be recharged once every 6 months, and the amount of electric charge shall exceed 80% of the rated capacity.

Please charge the battery in 18 hours after it fully discharged or over-discharging protection mode is activated.

Formula of theoretical standby time: $T=C/I$ (T is standby time, C is battery capacity, I is total current of all loads).

The surface of the product cabinet is affixed with a torn invalid label. Therefore, before opening the cover to change the DIP switch mode, you need to contact DYNESS and inform the product ID. DYNESS will record this battery ID and authorize the opening operation to be performed. Except for changing the DIP switch mode, no other operations are allowed. In the next stage, you can log in to apply for operations directly on the DYNESS website. Contact the authorized dealer or distributor of DYNESS for a new torn invalid sticker after tearing the original invalid label. When the operation is completed, paste the new one at a different position.

Preface

Manual Declaration

PowerHaus Lithium Iron Phosphate Battery is external battery module which can store the electricity for home use. When you apply the grid or photovoltaic system as your powers supply, the product can collect electricity to charges the battery. When grid or photovoltaic system is power off , the product can supply electricity itself for your home loads.

PowerHaus User manual systematically elaborates device structure, parameters, basic procedure and method of installation, operation, maintenance.

Safety Statement

Only qualified trained professionals are allowed to install, operate, maintain the device. Please comply with local safety regulations and operational rules during installation, operation and maintenance, or it could cause unexpected injury or device damage. The safety declaration mentioned in the manual are only supplement context for your local safety regulations.

The seller does not undertake any responsibility for device operations or usage of violating general safety requirements and safety standards.

Sign Explanation

User should clear the meaning of the caution sign below when configuring or operating PowerHaus series products.



Neglecting the warnings might cause equipment failure.

1 Introduction

Brief Introduction

PowerHaus series is equipped with lithium iron phosphate battery for family use . We base on customer needs and market requirement to develop cutting-edge battery storage technology and offer this high quality product to supply stable electricity for all kind of user's devices. The product have long life span and can be applied in high temperature environment and take less space for installation.

PowerHaus series carries self-developed battery management system. When you apply the grid or photovoltaic system as your powers supply, the product can collect electricity to charges the battery. When grid or photovoltaic system is power off , the product can supply electricity itself for your home loads. Products also can be paralleled to build a multi-module system with more capacity to satisfy the longtime energy storage demand.

Product Properties

PowerHaus series energy storage product's anode materials are lithium iron phosphate, battery cells are managed effectively by BMS with better performance, the systems features as below:

Comply with European ROHS, Certified SGS, employ non-toxic, non-pollution environment-friendly battery.

Anode materials are lithium iron phosphate (LiFePO₄), high safety performance with longer life span.

Equipped with BMS (battery management system) mode with better performance, possesses protection function like over-discharge, over-charge, over-current, abnormal temperature.

Self-management on charging and discharging, Single core balancing function.

Intelligent design configures integrated inspection module.

Flexible configurations allow parallel of multi battery for longer standby time.

Self-ventilation with lower system noise.

Less battery self-discharge, then recharging period can be up to 10 months during the storage.

No memory effect so that battery can be charged and discharged shallowly.

With wide range of temperature for working environment, -20°C ~ +55°C, circulation span and discharging performance are well under high temperature.

Less volume, lighter weight, seal grade up to IP65 embedding design for easier installation and maintenance.

Product Identity Definition

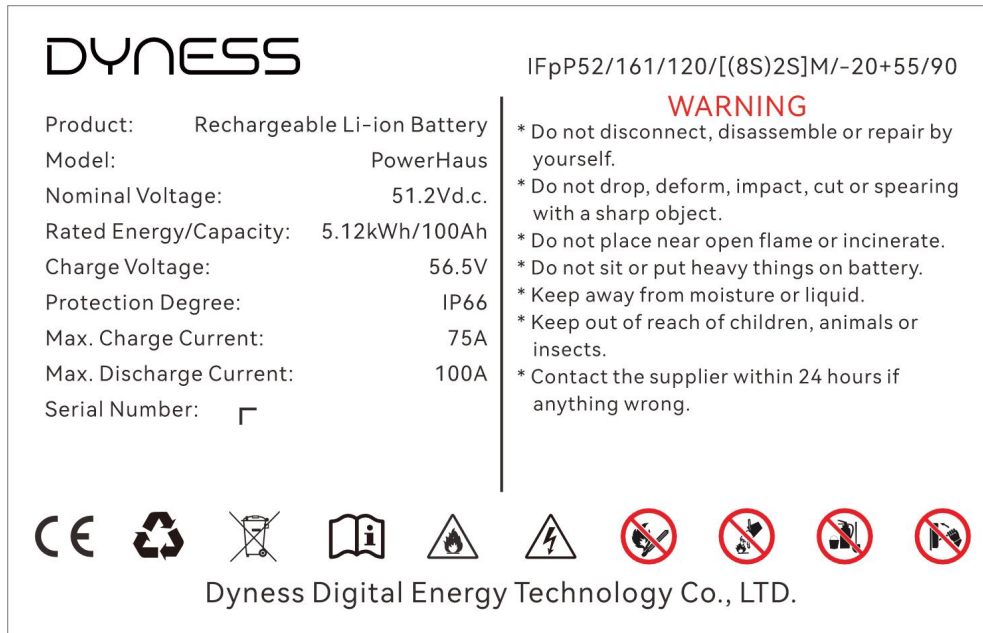

Figure 1-1 Battery Energy Storage System nameplate



Figure 1-2 Labels with heating function

(Only systems with heating function will be labeled with this label)

Table 1-1 Symbol Definition

	Battery voltage is higher than safe voltage, direct contact with electric shock hazard.
	Be careful with your actions and be aware of the dangers.
	Read the user manual before using.
	The scrapped battery cannot be put into the garbage can and must be professionally recycled.



After the battery life is terminated, the battery can continue to be used after it recycled by the professional recycling organization and do not discard it at will.



This battery product meets European directive requirements.



Do not place near open flame or incinerate.



If catch fire, do not put out with water.



If catch fire, do not put out with dry powder fire extinguisher.



Do not cut or spear with sharp objects.

2 Product Specification

Size and Weight

Table 2-1 PowerHaus Series Device Model

Product Series	Nominal Voltage	Nominal Capacity	Dimension (mm)	Weight (kg)	IP Level
PowerHaus	51.2V	100Ah	450×640×165	54.4	IP66

Performance Parameter

Table 2-2 PowerHaus performance parameter

Item	PowerHaus
Nominal Voltage(V)	51.2
Work Voltage Range(V)	44.8~57.6
Nominal Capacity(Ah)	100Ah
Nominal Energy(kWh)	5.12
Nominal Power(kW)	5.12
Peak Power(kW)	5.12
Max Charging Current(A)	75
Max Discharging Current(A)	100
Peak Discharging Current(A)	200(2min)

Interface Definition

This section elaborates on interface functions of the front panel of the device.

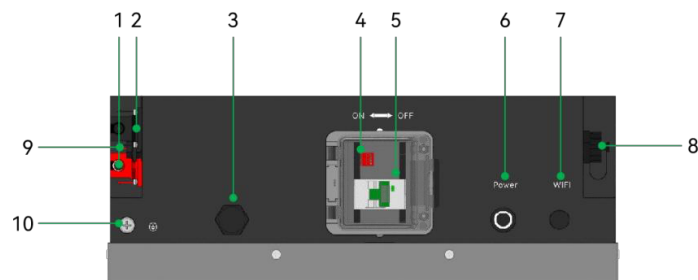

Figure 2-1 PowerHaus the Sketch of Front Interface

Table 2-3 Interface Definition

Item	Name	Definition
1	Positive socket	The battery DC output positive pole, which is connected to the positive pole of the inverter through the cable
2	Negative socket	The battery DC output negative pole, which is connected to the negative pole of the inverter through the cable
3	Explosion proof valve	Due to the rapid increase in pressure inside the battery box, the explosion-proof valve exhaust port is opened to quickly and directionally release the internal gas, thereby preventing the battery box from exploding
4	DIP	Master communication baud rate selection
5	DC circuit breaker	Circuit protection
6	Reset switch	Press the switch and the battery system turn on. When the battery is in the non-use state such as storage, transportation etc., it needs to be turn off by pressing the Reset switch button, and the battery system will automatically sleep after the device without external load and power for 72 hours
7	Wifi	Monitoring and optimizing battery systems
8	COM OUT	When the system is used independently: This CAN socket is a reservation interface When the system is used in parallel: This CAN communication socket is connected to the COM IN interface of the next PowerHaus through communication cable. (Factory default CAN communication mode)
9	COM IN	When the system is used independently: The CAN socket is connected to the inverter CAN/RS485 interface through the communication cable. When the system is used in parallel: This CAN communication socket is connected to the COM OUT interface of the previous PowerHaus through communication cable. (Factory default CAN communication mode)

Item	Name	Definition
10	Ground connection point	Shell ground connection

Table 2-4 Reset switch Status Indicators

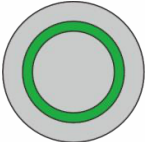
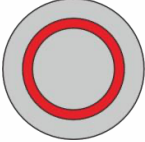
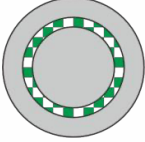
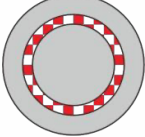
Reset switch Status	Information
<p>Green light on</p> 	Normal operation
<p>Red light on</p> 	System protection
<p>Green light flashing</p> 	DIP switch undefined
<p>Red light flashing</p> 	Communication failure between batteries

Battery Management System(BMS)

Voltage Protection

Low Voltage Protection in Discharging:

When any battery cell voltage or total voltage is lower than the rated protection value during discharging, the over-discharging protection is activated, and the battery buzzer makes an alarm sound. Then battery system stops supplying power to the outside. When the voltage of each cell back to rated return range, the protection is over.

Over Voltage Protection in Charging:

During charging stage, the system will stop charging when the total voltage of the battery pack is higher than rated value or the voltage of any single cell reaches the protection value. When total voltage or all cell back to rated range, the protection is over.

Current Protection

Over Current Protection in Charging:

When the charge current of any module $> 90A$, current limit protection mode is activated, current will be limited to $\leq 3A$, protection is removed after rated time delaying 10s.

Circulate like this until the current is lower than 90A.

Over Current Protection in Discharging:

When the discharge current of any module is higher than 205A, the battery buzzer alarms and the system stops discharging at once. After protection, the discharging will restore in 60secs delay or immediately when there is charging current.



CAUTION

The buzzer sound alarm setting can be manually turned off on the background software, and the factory default is on.

Temperature Protection

Low/Over temperature protection in charging:

When battery's temperature is beyond range of $0^{\circ}C \sim +65^{\circ}C$ during charging, temperature protection be activated, device stops charging. The protection is released when it back to rated range of working temperature.

Low/Over temperature protection in discharging:

When battery's temperature is beyond range of $-20^{\circ}C \sim +65^{\circ}C$ during discharging, temperature protection be activated, device stops supplying power to the outside. The protection is released when it back to rated range of working temperature.

Other Protection

Short Circuit Protection:

When the battery is activated from the off state, if a short circuit occurs, the DC circuit breaker will respond first. If the DC circuit breaker does not operate, the short circuit protection function of BMS will be activated automatically and cut off the device's output.

Self Shutdown:

When device connects no external loads for over 72 hours, device will dormant standby automatically.

**CAUTION**

The maximum operating current required for the electrical load shall be less than the maximum discharge current capacity of the battery.

3 Installation and Configuration

Preparations for Installation

Safety Requirement

This system can only be installed by personnel who have been trained in the power-supply system and have sufficient knowledge of the power system.

The safety regulations and local safety regulations listed below should always be followed during the installation.

- All circuits connected to this power system with an external voltage of less than 48V must meet the SELV requirements defined in the IEC60950 standard.
- If operating within the power system cabinet, make sure the power system is not charged. Battery devices should also be switched off
- Distribution cable wiring should be reasonable and has the protective measures to avoid touching these cables while operating power equipment.
- The following protective items must be worn when installing the battery system:



Insulated Gloves



Safety Goggles



Safety Shoes

Figure 3-1 Safety Gear

Environmental requirements

Working temperature: $-20^{\circ}\text{C}\sim+55^{\circ}\text{C}$

Charging temperature range is $0^{\circ}\text{C}\sim+55^{\circ}\text{C}$

Note: When selecting a heating film, the charging temperature range is $-20^{\circ}\text{C}\sim+55^{\circ}\text{C}$

Discharging temperature range is $-20^{\circ}\text{C}\sim+55^{\circ}\text{C}$

Storage temperature: $-10^{\circ}\text{C}\sim+35^{\circ}\text{C}$

Relative humidity: 5% ~ 85%RH

Elevation: no more than 4000m

Operating environment: Indoor or outdoor installation, sites avoid the sunlight and no wind, no conductive dust and corrosive gas.

And the following conditions are met:

- Installation location should be away from the sea to avoid brine and high humidity environment.

- The ground for product arrangement shall be flat and level.
- There is no flammable explosive materials near to the installation site.
- The optimal ambient temperature is 15°C~30°C
- Keep away from dust and messy zones

Installation location precautions

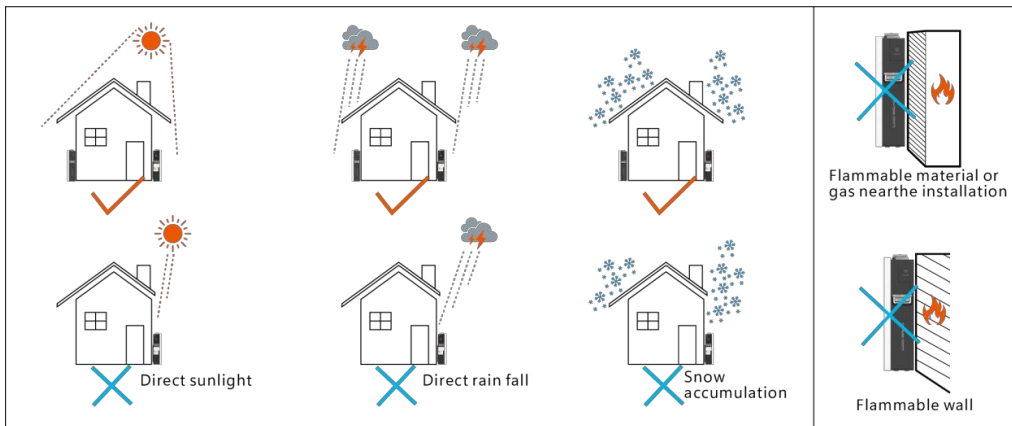

Tools and data

Tools and meters that may be used are shown in Figure 3-2 Installation Tools.

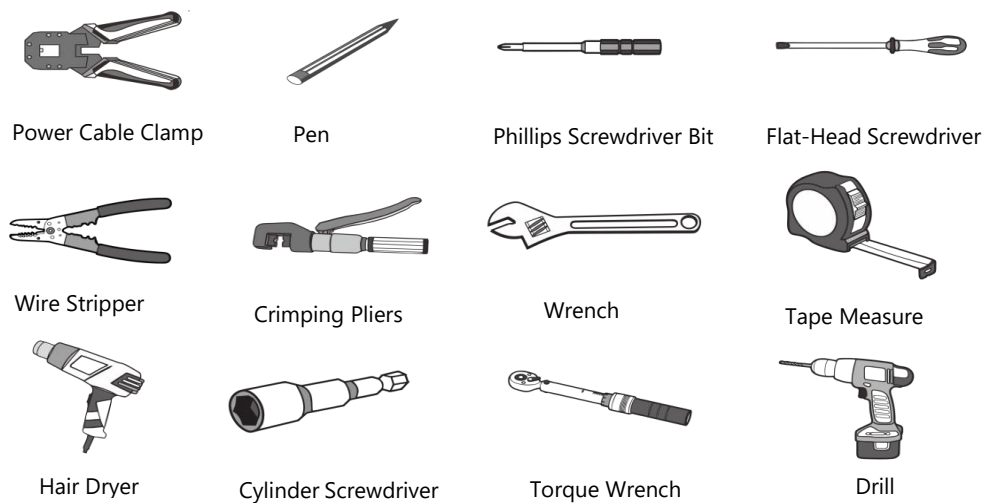

Figure 3-2 Installation Tools

Technical Preparation

Electrical interface check

Devices that can be connected directly to the battery can be user equipment, power supplies, or other power supplies.

- Confirm whether the user equipment, the PV equipment or other power supply equipment has the DC output interface, and measure whether the output voltage of the standby interface meets the requirements of the voltage range of table 2-2
- Verify that the maximum discharge current capacity of the user equipment, the PV equipment or other power supplies, the DC standby interface, and the maximum discharge current shall be greater than the maximum charging current of the products used in table 2-2.
- If the user equipment DC prepared interface maximum discharge capacity is less than the maximum charging current products using table 2-2, the user interface should have the power equipment of DC current limiting function, give priority to ensuring the normal work of user equipment.









The security check

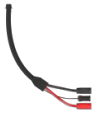

- Firefighting equipment should be arranged near the equipment, such as portable dry powder fire extinguisher.
- Automatic fire fighting system shall be provided for the case where necessary.
- Flammable, explosive and other dangerous materials placed beside the battery are prohibited.

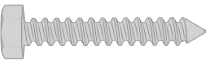
Unpacking Inspection

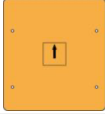
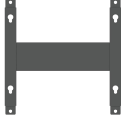
- When the equipment arrives at the installation site, loading and unloading should be carried out according to the rules and regulations, so as to prevent from being exposed to sun and rain.
- Before unpacking, the total number of packages shall be indicated according to the shipping list attached to each package, and the case shall be checked for good condition.
- In the process of unpacking, handle with care and protect the surface coating of the object.
- Open the package, the professional installation personnel should read the technical documents, verify the list, according to the configuration table and packing list, ensure objects are complete and intact. If the internal packaging is damaged, it must be inspected and recorded in detail.

Table 3-1 Packing list

Item	Specification	Quantity	Figure
Battery	PowerHaus 51.2V/100Ah	1	
Three in one power cord	Black /9AWG/L1500mm	1	
User Manual	User manual	1	
Slotted Pan Head Screws With Shoulder	M8	4	
Expansion Bolt	M6	4	
Hexagon Head Tapping Screw	M6	4	
Unlock Piece-BLACK	/	1	
Positioning cardboard	Positioning cardboard	1	
Wall bracket	Wall bracket	1	
Letter to customer	/	1	

Warranty card	/	1	
Packing list	/	1	

Engineering Coordination

Attention should be paid to the following items before construction:

- Power cable specification.
- The power cable specification shall meet the requirements of maximum discharge current for each product.
- Mounting space and bearing capacity.
- Make sure that the battery has enough space to install, and that the battery rack and bracket have enough load capacity.
- Wiring.
- Make sure the power cable and ground wire are reasonable. Not easy to short-circuit, water and corrosion.

Equipment Installation

The wall for battery installation shall be solid brick or cement wall with strong bearing capacity and wall thickness no less than 100mm.

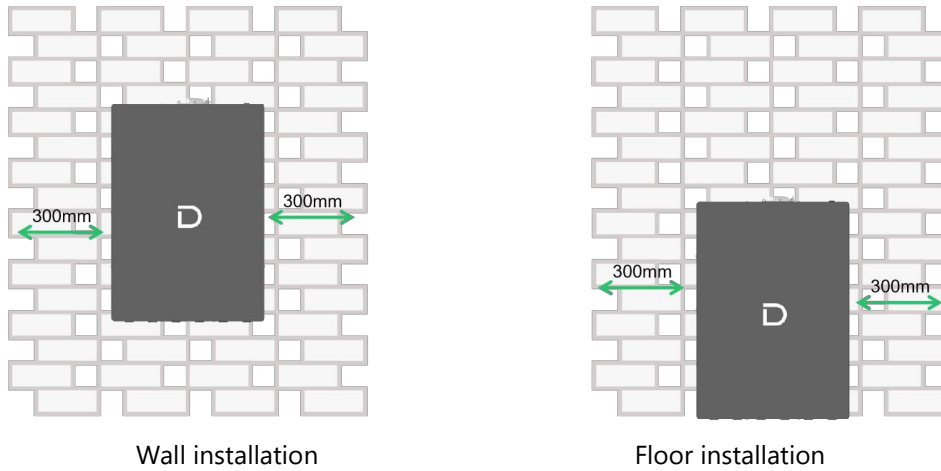

Figure 3-3 Mounting Space Requirements

Table 3-1 Installation Steps

Step 1 System outage
Ensure that the battery is in a shutdown state
Step 2 Mechanical installation
1. Hanger mounting
2. Equipment installation
Step 3 Electrical installation
1. Connect the ground cable
2. Electrical installation
3. Connect inverter
4. Communication interface connection

Wall hanging Installation method:

The following accessories need to be added when install the PowerHaus on the wall.

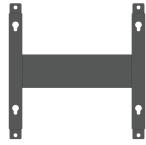

Wall bracket × 1

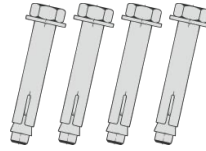

Expansion Screw × 4

1. Use the positioning cardboard (provided in accessory package) and mark the screw hole positions on the wall.
2. The cardboard must be perpendicular to the ground while drawing the holes.
3. The bottom of the cardboard is about 300mm from the ground.
4. According to the position of the mark, 4 holes in diameter 10mm and depth of more than 70mm are hit on the wall with an electric drill, which are used for fitting expansion bolt M6.

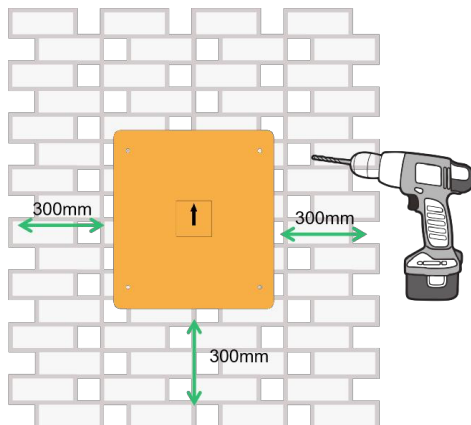

5. Fix the wall bracket on the wall with M6 expansion screw, twisting force keeps 9.8N·m.

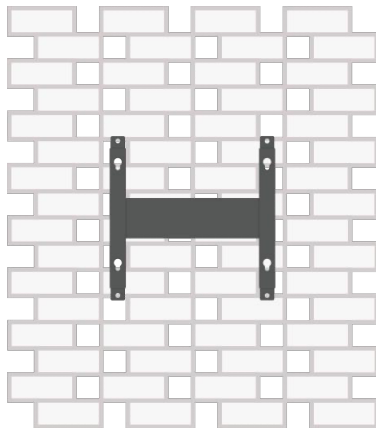

6. As shown on the right, lock four M8 step screws to the battery module. Twisting force keeps 11.8N·m.

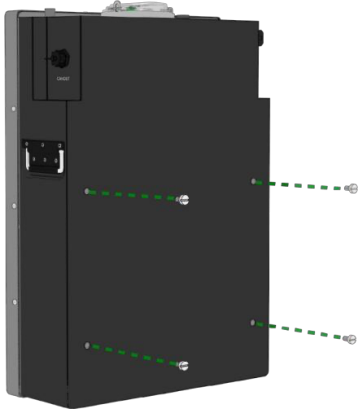

7. When PowerHaus battery wall hanging installing, pay attention to insert the six screw heads on the back of the chassis into the slot on the wall hanging.

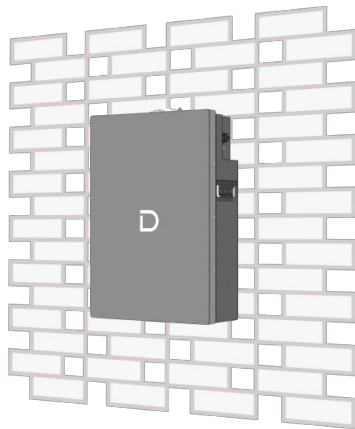

Electrical installation

Before connecting the power cables, using multimeter to measure cable continuity, short circuit, confirm positive and negative, and accurately mark the cable labels.

Measuring method:

Power cable check: Select the buzzer mode of multimeter and detect the both ends of the same color cable. If the buzzer calls, it means the cable is in good condition.

Short circuit judgment: Choose multimeter resistor file, probe the same end of positive and negative pole, if the resistor shows infinity, means that the cable is available.

After visual testing of power line is connection, the positive and negative poles of the battery shall be connected respectively to the positive and negative poles of the opposite terminal.

1. Connect the battery box to the ground cable

Customer needs to prepare a M6 OT terminals and ground cables. Ground the battery shell as shown below. The sectional area of the grounding cable shall be at least 6mm² and the bolt locking torque is 6NM.

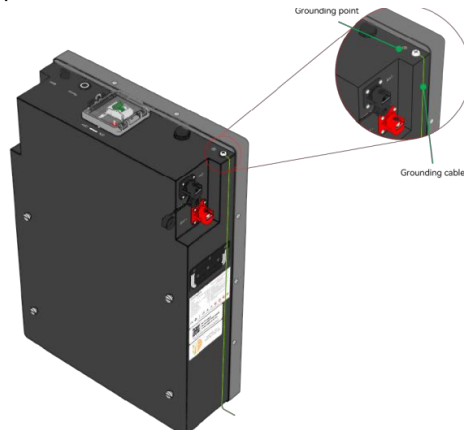

CAUTION

If there is any question during installation, please contact your dealer to avoid damage to the equipment.

2. Inverter Connection

When the system is used independently:

Note: Before installation, please confirm whether the DIP switch mode of the PowerHaus is correct according to use's inverter communication specification. For specific DIP operation methods, please refer to "P24 Battery module DIP switch definition and description".

The battery is connected to the inverter, requires the use of a dedicated three-in-one power line (as accessories shipped with the cargo, the standard communication cable is a standard network cable. The applicable inverter is marked on the label of the network cable. If the inverter used by the customer is not covered by the standard communication cable, please contact DYNESS for the correct PIN Sequence) as follows:

- Keep the battery system at power off state, connect the power cable to the interface on the input side of the inverter first, and then connect the power cable to the interface on the battery side.
- The battery output interface is a waterproof connector, and the three-in-one power line plug needs to be locked into the battery socket. The power cable cross section is 3AWG.

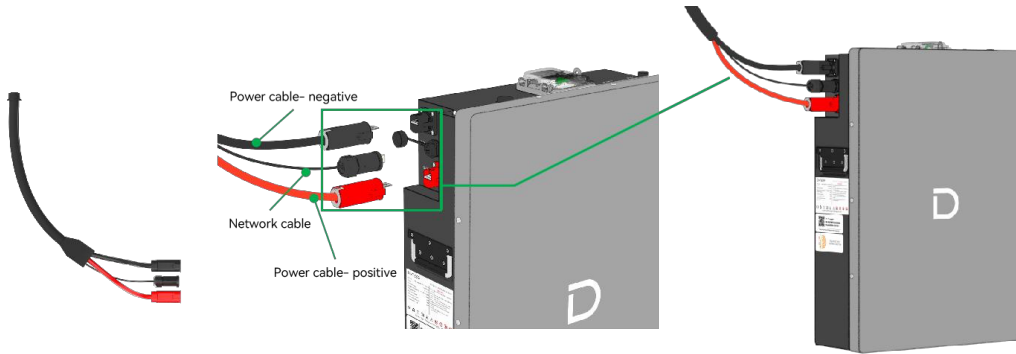

Waterproof plug installation drawing

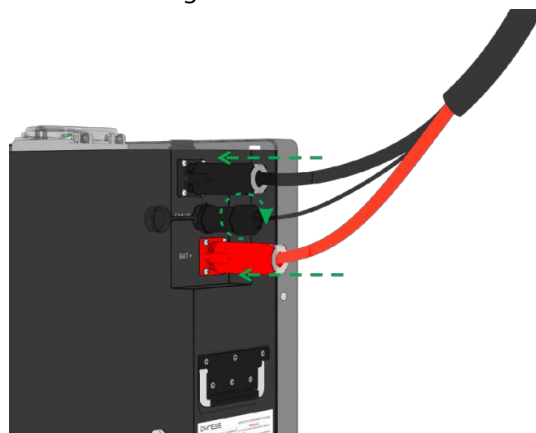

Unlocking component usage instructions

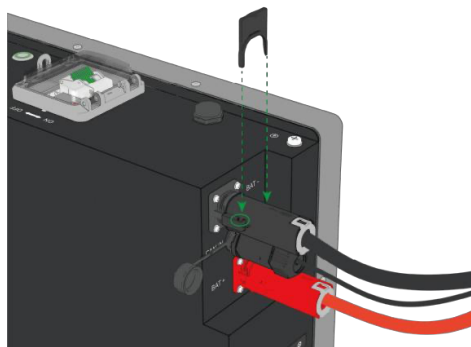

Table 3-2 Pin Definition(CAN IN)

Foot position	Color	Definition
PIN1	Orange/white	485B
PIN2	Orange	485A
PIN3	Green/white	Reserve
PIN4	Blue	EXT CANH

PIN5	Blue/white	EXT CANL
PIN6	Green	Reserve
PIN7	Brown/white	INT CANH
PIN8	Brown	INT CANL

(CAN OUT)

Foot position	Color	Definition
PIN1	Orange/white	Reserve
PIN2	Orange	Reserve
PIN3	Green/white	Reserve
PIN4	Blue	Reserve
PIN5	Blue/white	Reserve
PIN6	Green	Reserve
PIN7	Brown/white	INT CANH
PIN8	Brown	INT CANL

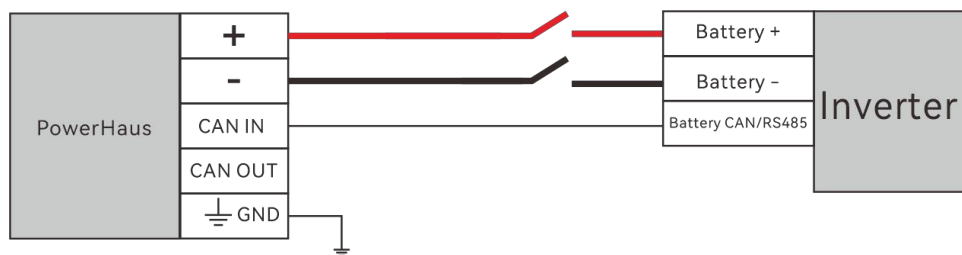
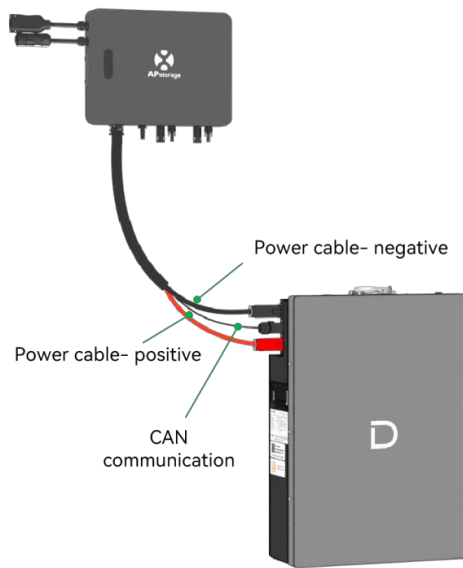



Battery Module DIP Switch Definition and Description

Table 3-3 DIP switch Definition

DIP switch position (master communication protocol and baud rate selection)			
#1	#2	#3	#4
Define different protocols; Distinguish between master and slave			Baud rate selection
			OFF: CAN: 500K,485: 9600
			ON: CAN: 250K,485: 115200

Table 3-4 DIP Switch Description

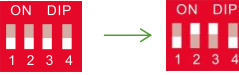
DIP Switch Description
<p>1. If the battery communicates with APsystems(Specifically referring to EZHI) turn the master DIP switch "#1" to "ON" position.</p> <div style="text-align: center;">  <p style="color: red; margin-left: 20px;">Master Setting 1</p> </div>
<p>2. If the battery communicates with SMA、Victron、Ingeteam、Solplanet、SOFAR、Deye、Hoymiles、APsystems、LUXPOWER、MUST、SOSEN、Afore turn the master DIP switch "#3" to "ON" position.</p> <div style="text-align: center;">  <p style="color: red; margin-left: 20px;">Master Setting 2</p> </div>
<p>3. If the battery communicates with the Axpert-king/VMIII/MAX, Infinisolar, Growatt SPH/SPA(CAN comm), turn the master DIP switch "#2" to "ON" position.</p> <div style="text-align: center;">  <p style="color: red; margin-left: 20px;">Master Setting 3</p> </div>
<p>4. If the battery communicates with the Growatt SPF HVM-P/ES/WPV by RS485 communication, turn the master DIP switch "#2" and "#3" to "ON".</p> <div style="text-align: center;">  <p style="color: red; margin-left: 20px;">Master Setting 4</p> </div>

5. If the battery communicates with the Schneider Conext Series, turn the master DIP switch "#1" and "#3" to "ON".



6. When you setup the master DIP as setting 1~4, all the slaves keep the DIP 0000, no need to change.

7. If the energy storage system has only one PowerDepot G2, it is the master itself, and still follow the above steps.

Note: For more information of matching inverter brands, please subject to the latest document <The list of compatibility between Dyness ESS and Inverters >.



CAUTION

- Before connection, the positive and negative pole of the inverter input interface and the battery output interface should be confirmed.
- The red power line is connected to the positive pole and the black power line is connected to the negative pole.
- Before connection, it is necessary to confirm the charge and discharge parameters of the inverter interface.
- Voltage and current should meet the requirements of Table 2-2 battery performance parameters.
- Note: For more information of matching inverter brands, please subject to the latest document <The list of compatibility between Dyness ESS and Inverters >.
- The following operations can only be performed after being authorized by DYNES:
- How to judge that the communication between the product is normal:
 - 1.If there is communication between the inverter and battery system, it can be judged by the maximum charge and discharge current value on the inverter sent by the battery.
(The maximum charge and discharge current value display on the inverter)/(The maximum charge and discharge current value of one battery module)=number of modules
 - 2.If the equation holds after calculation, it means communication between the PowerHaus is normal.
 - 3.If the master battery LED flashes yellow, it means the communication between PowerHaus is fault.

Table 3-5 Battery usage recommendations

Equipment Use	Charging	1.The battery's long-term continuous charging current should be $\leq 0.5C$. 2.If the battery remaining capacity is empty, please charge it within 48 hours after the battery is empty.
	Discharging	3.The long-term continuous discharge current of the battery should be $\leq 1C$. 4.The recommend maximum depth of discharge (DOD) of Battery PACK is no more than 95%.

Battery Parameter Settings on the Inverter

Max Charging(Bulk) Voltage: 57.6V

Absorption Voltage: 56.5V

Float Voltage: 56V

Shut Down(cut off) Voltage: 48V

Shut Down(cut off) SOC: 5%

Restart Voltage: 52V

Max Charge Current:75A

Max Discharge Current: 100A

4 Use, Maintenance and Troubleshooting

Battery System Usage and Operation Instructions

After completing the electrical installation, follow the instruction below to start the battery system.

1. Check whether the breaker is in ON state.

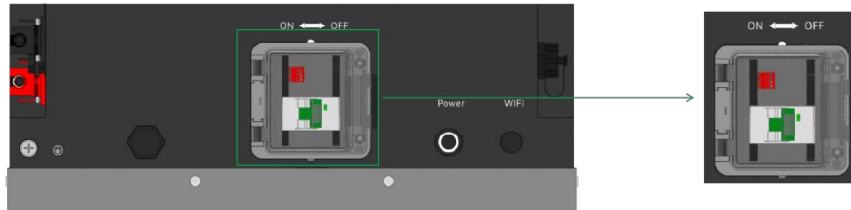

2. Press the battery power button. After the self-inspection is completed, the reset switch indicator light will always be green, and the battery enters the standby state.



CAUTION

- After pressing the wake/sleep button, If the reset switch indicator light is steady red, please refer to the "Alarm description and processing". If the failure cannot be eliminated, please contact the retailer timely.
1. Use a voltmeter to measure whether the voltage across the BAT + / BAT- terminals of the inverter is higher than 44.8V, and check whether the voltage polarity is consistent with the input polarity of the inverter. If the voltage across the terminals BAT + / BAT- of the inverter is higher than 44.8V, which means the battery has begun to work normally.
 2. After confirm the battery output voltage and polarity are correct, turn on the inverter.
 3. Check whether the indicator light for the inverter and the battery connection (the communication indicator and the battery access status indicator) is in normal condition. If normal, the connection between the battery and the inverter is completed. If the indicator light show abnormal, please check the inverter manual or contact the local dealer.

Alarm Description and Processing

When protection mode is activated or system failure occurred, the reset switch indicator light panel alarm, through net management can query specific alarm class and take appropriate action.

Alarm and countermeasure for affecting system output

If there are any abnormalities affecting the output, such as battery cell in the battery module occurs over-current protection during charge/discharge, under-voltage protection, and temperature protection, in the system, please deal with them according to Table 4-1.

Table 4-1 Main Protection

Statue	Alarm category	Alarm indication	Processing
Charge state	Over-current protection when charge	Reset switch red light Always on Buzzer start	Stop charging and reduce charge current below rated value.
	High temp protection when charge	Reset switch red light Always on	Stop charging and find out the cause of the trouble.
Discharge state	Over-current protection when discharge	Reset switch red light Always on Buzzer start	Stop discharging and reduce discharge current below rated value.
	High temp protection when discharge	Reset switch red light Always on	Stop discharging and find out the cause of the trouble.
	Over-discharged protection	Reset switch red light Always on Buzzer start	Start charging.

Analysis and Treatment of Common Faults

Table 4-2 Analysis and Treatment of Common Faults

Item	Fault phenomenon	Reason analysis	Solution
1	The indicator does not respond after power on the system	Make sure press and hold the power switch (Reset switch) for 3s.	Check the power switch

2	No DC output after power on the system	Check if the DC breaker is turned on	Check the status of the DC circuit breaker on the side of cabinet
3	No DC output and Reset switch red light is on, buzzer beeping	Battery voltage is too low	Charging the battery system
4	The battery cannot be fully charged	Charging voltage is too low	Adjust charging voltage within 56.5V~57.6V range
5	The power cable sparks once power on and Reset switch red light is on	Power connection short-circuit	Turn off the battery, check the cause of the short circuit
6	Master battery Reset switch red light flashing	Abnormal communication between batteries	Check if the communication network cable connection between the batteries is correct

If you need any technical help or have any question, please contact the dealer in time.

DYNESS

Address: No.688, Liupu Road, Guoxiang Street, Wuzhong Economic Development Zone,
Suzhou, Jiangsu, China
Email: service@dyness-tech.com
Tel: +86 400 666 0655
Web: www.dyness.com



Official Website



Digital version access