

HR12200W

Valve-regulated lead-acid battery



HIGH RATE SERIES

Characteristics

Nominal voltage	12V (6 cells per unit)	
Nominal power at 15 min. rate 1.67V/cell (25°C)	200W	
Capacity (25°C)	10 Hours rate/10.8V	55Ah
	5 Hours rate/10.8V	48Ah
Terminal type	T14	
Torque	5.1±0.6N.m	
Approx. internal resistance (25°C)	6.5 mΩ	
Dimensions	Length	230±2mm (9.06inch)
	Width	138±2mm (5.43inch)
	Height	211±2mm (8.31inch)
	Total height	215±2mm (8.46inch)
Design Life (stand-by)	JIS at 25°C	10 years
	Eurobat at 20°C	10-12 years
Weight	17.30kg (38.10lbs)±3%	
Nominal operating temperature	25±3°C (77°F±5)	
Operating temperature range	Discharge	-15°C~50°C (5°F~122°F)
	Charge	-10°C~50°C (14°F~122°F)
	Storage	-20°C~50°C (-4°F~122°F)
Float charging voltage at 25°C	13.5V~13.8V	
Cyclic charging voltage at 25°C	14.5V~15.0V	
Temperature compensation	Float charge	-18 (mV/°C/Block)
	Cycle charge	-30 (mV/°C/Block)
Max. charging current (A)	16.0A	
Max. discharge current for 5 seconds	550A	
Self discharge rate (25°C)	≤3%/month	
Battery container ABS UL94-HB	V-0 optional	

Overview

NPP Power High Rate series batteries are specially designed for applications that require high power output. With their high-power density and low internal resistance, the HR series are the right choice for your most demanding applications.

Dimensions & Terminal Type (mm)

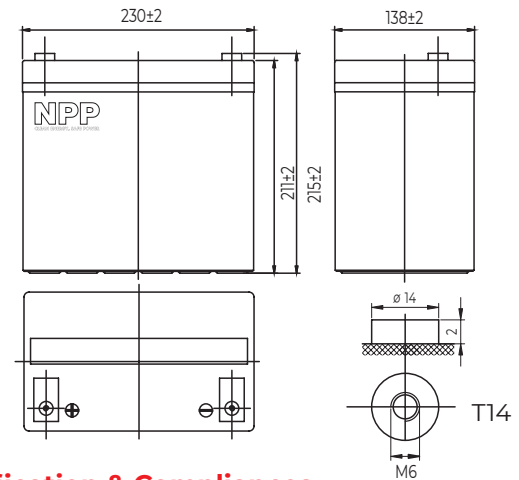

Certification & Compliances



Compliant to: EUROBAT, RoHS, WEEE's and Reach.
Manufactured according to IEC 60896-21 / 22

Construction

Component	Positive Plate	Negative plate	Container	Separator	Electrolyte	Safety valve	Terminal
Raw material	Lead dioxide	Lead	ABS	AGM	Sulfuric Acid	Rubber	Copper

Constant current discharge characteristics at 25°C

(Ampere/cell)

F.V/Time	10min	15min	20min	30min	45min	60min	2h	3h	4h	5h	6h
1.60V/cell	159.69	121.30	94.26	67.44	47.36	38.64	20.10	14.40	11.60	10.10	8.64
1.67V/cell	152.38	117.89	90.51	65.21	45.89	37.70	19.90	14.30	11.50	10.00	8.56
1.70V/cell	148.72	114.49	88.63	64.10	45.05	37.17	19.80	14.20	11.50	9.97	8.53
1.75V/cell	141.40	110.07	85.66	62.54	43.89	36.44	19.50	14.10	11.40	9.90	8.47
1.80V/cell	134.09	104.29	81.14	60.20	42.32	35.28	19.00	13.70	11.00	9.60	8.22

Constant power discharge characteristics at 25°C

(Watts/cell)

F.V/Time	10min	15min	20min	30min	45min	60min	2h	3h	4h	5h	6h
1.60V/cell	284.13	212.18	181.85	133.95	96.03	74.66	39.20	28.40	22.90	20.00	17.10
1.67V/cell	271.43	200.00	174.13	129.37	92.94	72.77	38.80	28.20	22.70	19.80	17.00
1.70V/cell	263.34	199.82	170.83	127.08	91.29	71.61	38.60	28.00	22.60	19.70	16.90
1.75V/cell	252.95	192.61	165.32	123.65	89.08	70.25	38.00	27.80	22.40	19.60	16.80
1.80V/cell	237.93	182.31	156.50	119.07	85.77	68.04	37.10	27.00	21.80	19.00	16.30

The above characteristics represent average values and can be obtained within three charge and discharge cycles. The batteries must be fully charged before testing. The data in this document is subject to change without notice and become contractual only after written confirmation. Please contact NPP Power for the latest available version.

NPP Power (Vietnam) Co., Ltd.

Lot A22.3, Road C4, Thanh Thanh Cong Industrial Zone,
An Hoa Ward, Trang Bang Town, Tay Ninh Province,
Vietnam

Guangzhou NPP Power Co., Ltd.

No.67 Lianglong Road, Huashan Town, Huadu District,
Guangzhou, China
Email: info@nppower.com.cn Tel. +86 20 37887 390

Discharge characteristics (25°C)

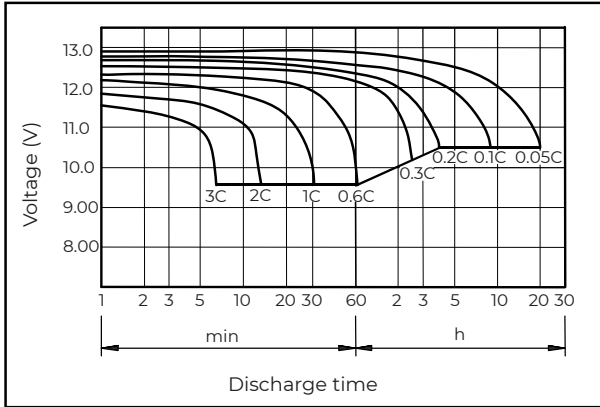

Charging characteristics (25°C)

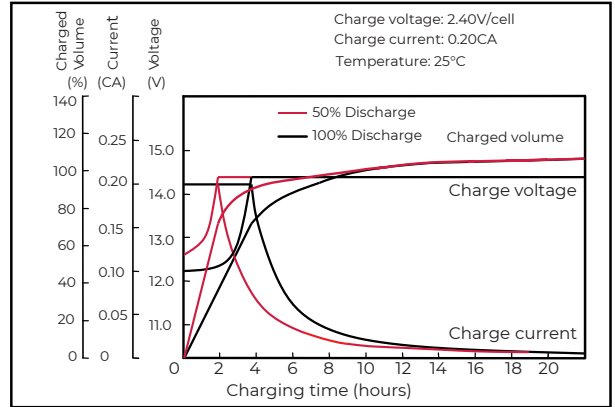

Temperature effects on capacity

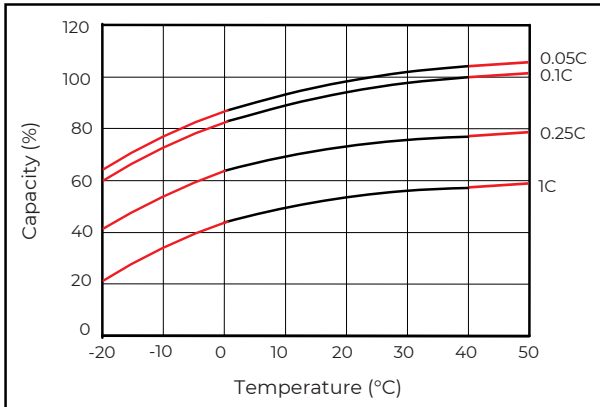

Self-discharge characteristics

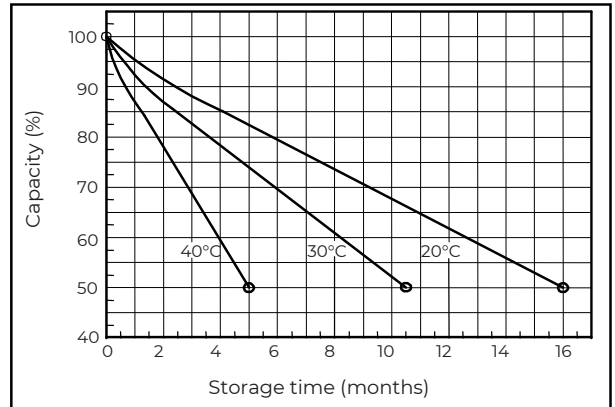

Floating life on temperature

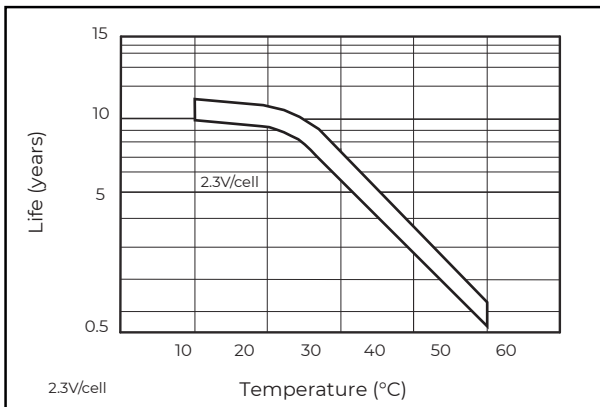

Cycle life on D.O.D (25°C)

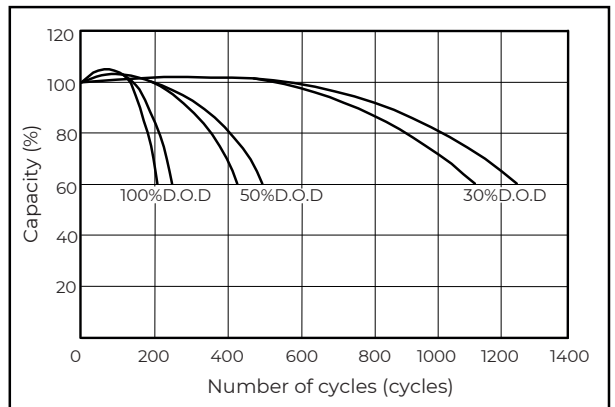

Relationship for OCV and capacity (25°C)

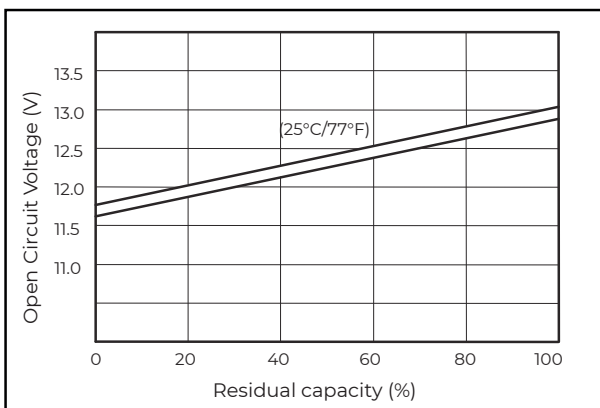

Charging voltage VS temperature

