

Зроблено в Україні ТМ «Pehotin»  
Made in Ukraine by «Pehotin»

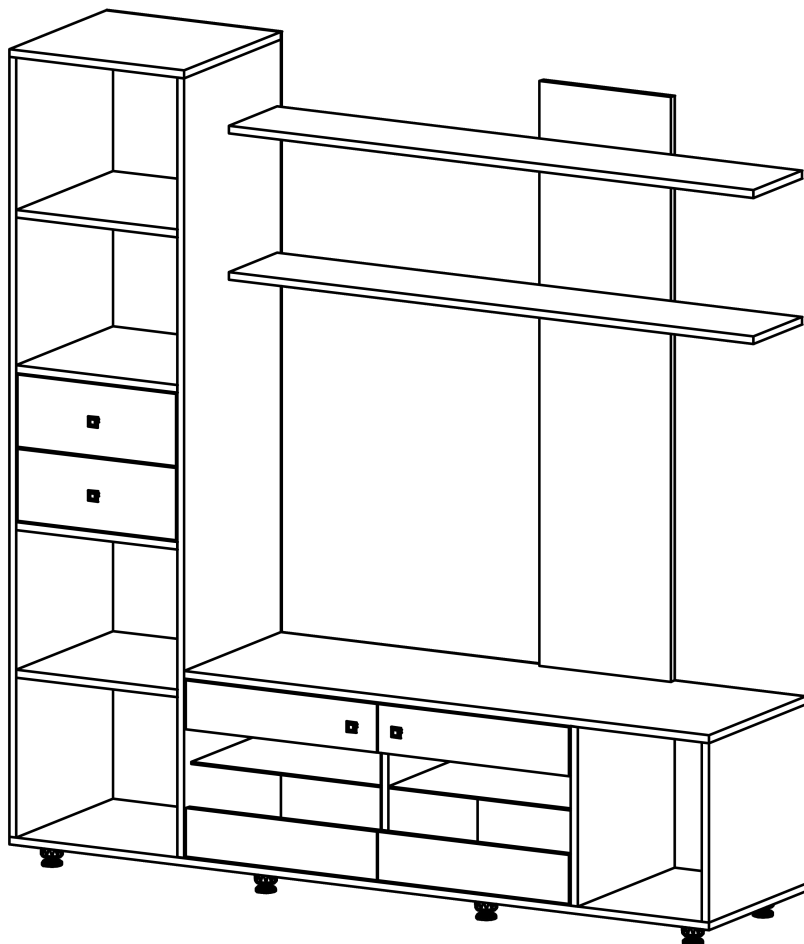

# Тумба ТВ «Мальта» TV Stand «Malta»



Д-1600, Ш-400, В-1670, мм.  
L-1600, W-400, H-1670, mm.

Інструкція збірки  
Assembly instruction

1



[pehotin@gmail.com](mailto:pehotin@gmail.com)  
[pehotin.com.ua](http://pehotin.com.ua)

«Мальта»/«Malta»

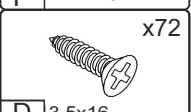
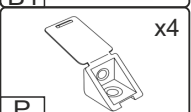
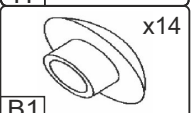
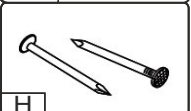
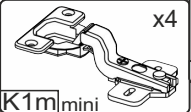
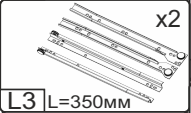
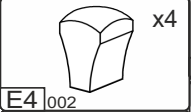
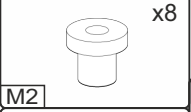
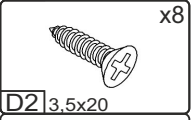
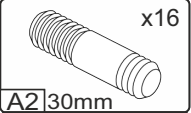
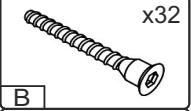
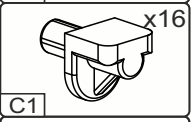
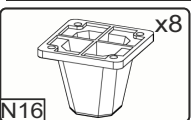

| №   | довжина(мм)<br>length(mm) | ширина(мм)<br>width(mm) | кількість<br>quantity |
|-----|---------------------------|-------------------------|-----------------------|
| 1.  | 400*                      | 400**                   | 1                     |
| 2.  | 1600*                     | 400                     | 1                     |
| 3.  | 1600*                     | 400                     | 1                     |
| 4.  | 368*                      | 390                     | 2                     |
| 5.  | 368*                      | 400                     | 1                     |
| 6.  | 814                       | 392                     | 2                     |
| 7.  | 368*                      | 100                     | 1                     |
| 8.  | 1200*                     | 400                     | 1                     |
| 9.  | 1200**                    | 300*                    | 1                     |
| 10. | 1200**                    | 190*                    | 2                     |
| 11. | 1205                      | 396                     | 1                     |
| 12. | 368*                      | 378                     | 1                     |
| 13. | 368*                      | 400                     | 1                     |

| №   | довжина(мм)<br>length(mm) | ширина(мм)<br>width(mm) | кількість<br>quantity |
|-----|---------------------------|-------------------------|-----------------------|
| 14. | 368*                      | 400                     | 1                     |
| 15. | 437                       | 228                     | 2                     |
| 16. | 437**                     | 100**                   | 1                     |
| 17. | 437**                     | 100**                   | 1                     |
| 18. | 437**                     | 100**                   | 1                     |
| 19. | 437**                     | 100**                   | 1                     |
| 20. | 431                       | 360                     | 2                     |
| 21. | 1600*                     | 400**                   | 1                     |
| 22. | 334*                      | 100                     | 4                     |
| 23. | 344*                      | 100                     | 2                     |
| 24. | 362**                     | 148**                   | 2                     |
| 25. | 340                       | 355                     | 2                     |

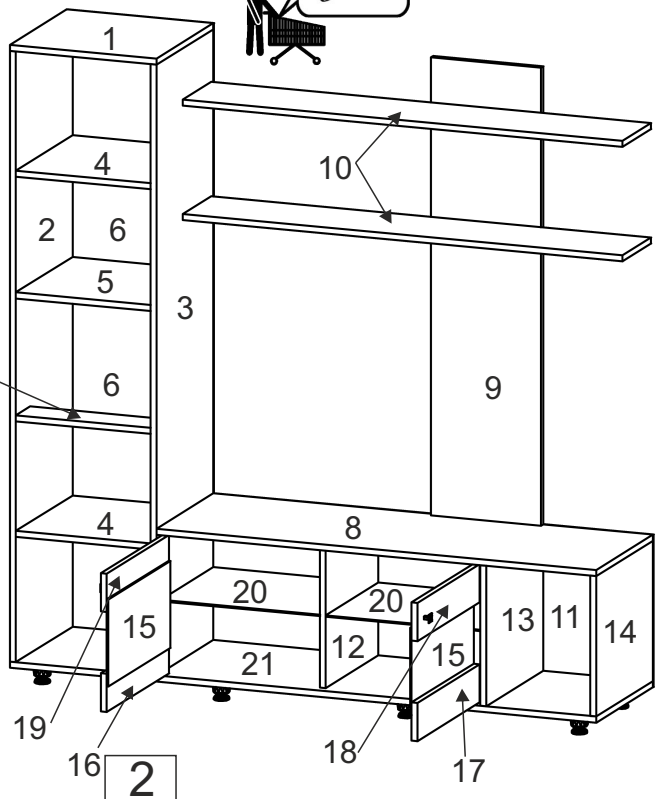
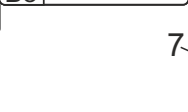
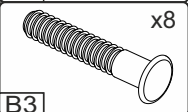
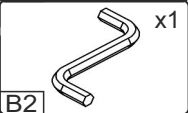
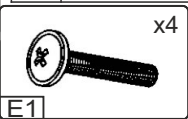

1.

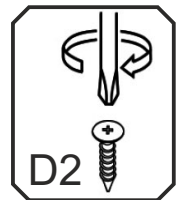
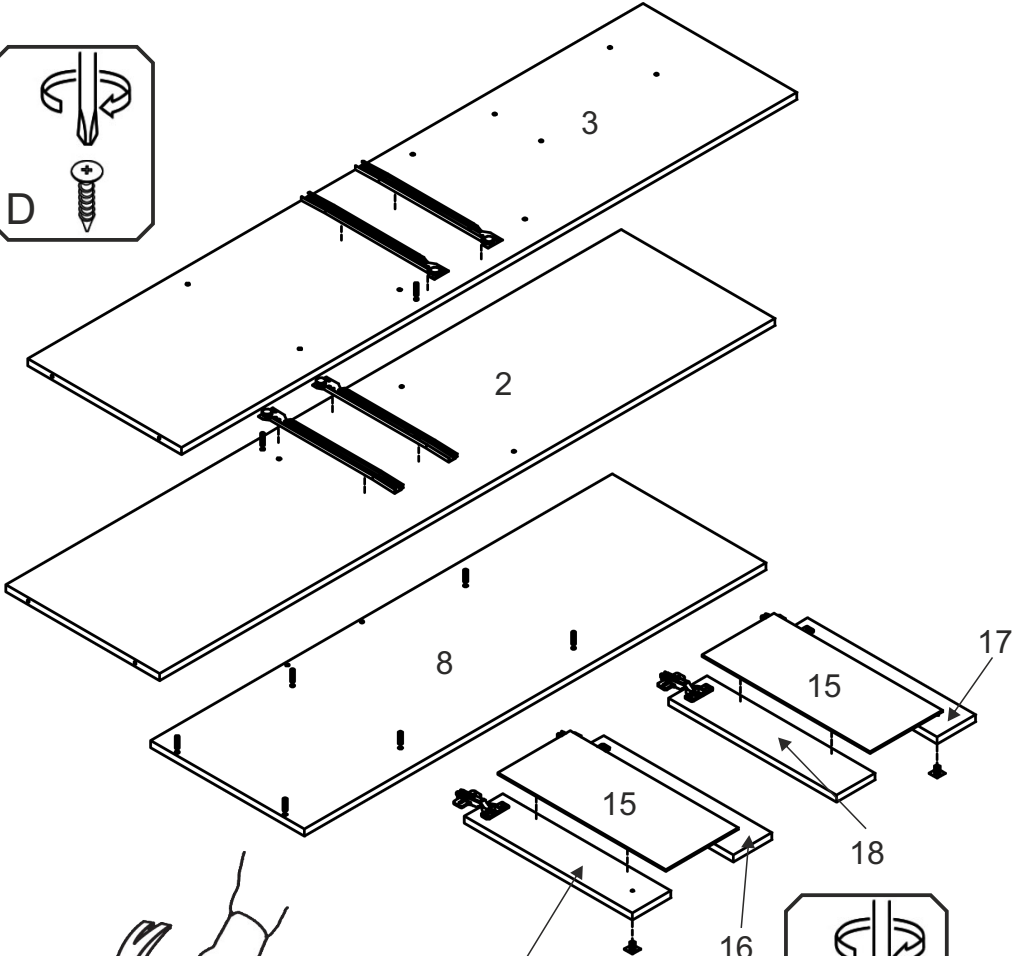
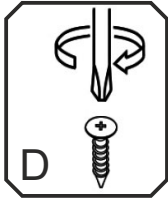
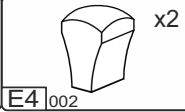
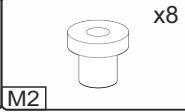
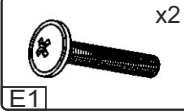
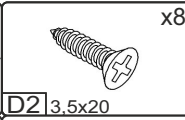
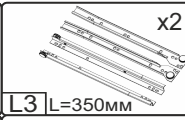
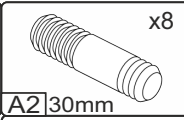
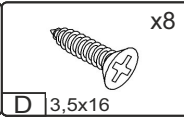
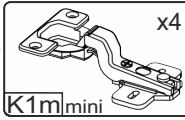

3

2.

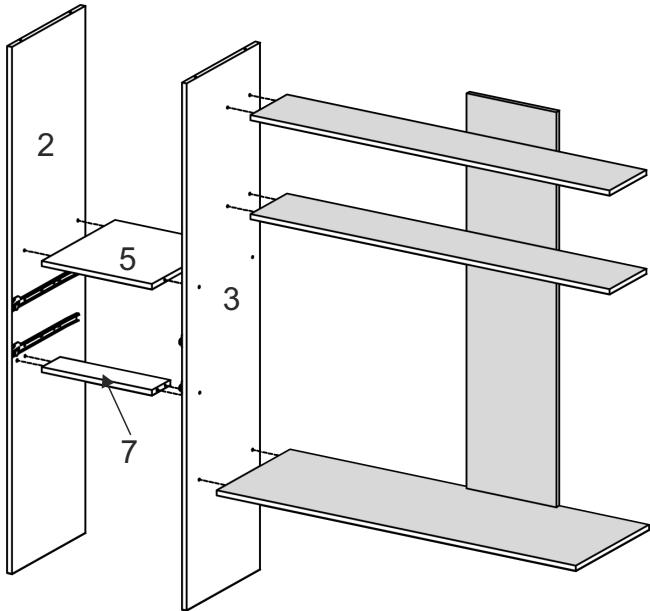
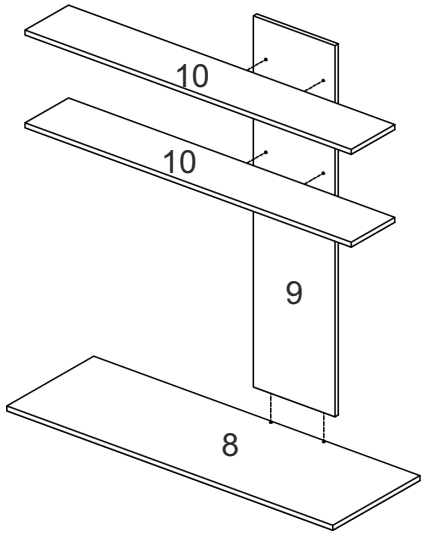
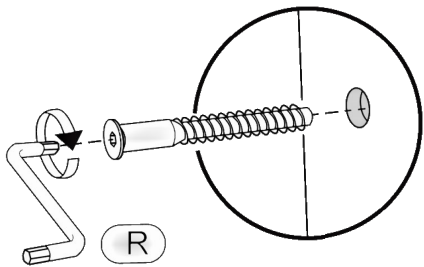
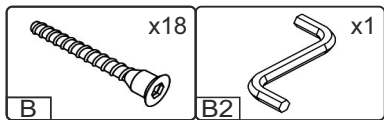

3.

- D** 3,5x16 x32
- H** N16
- B** x8
- B2** x14
- x1**

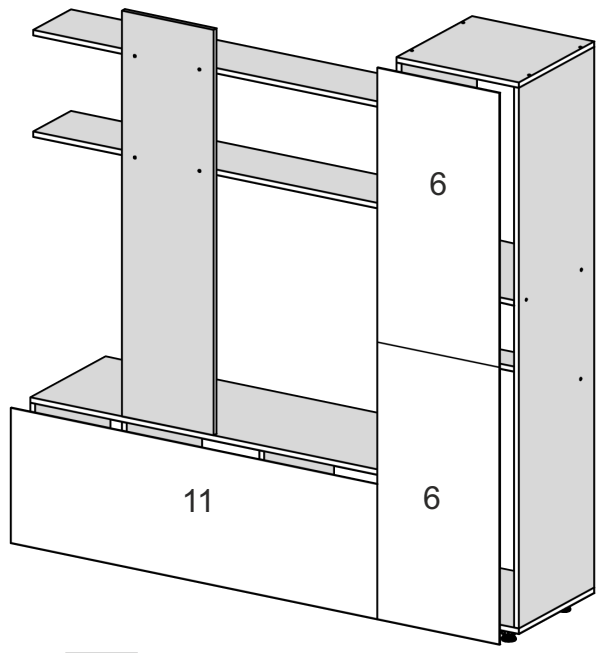
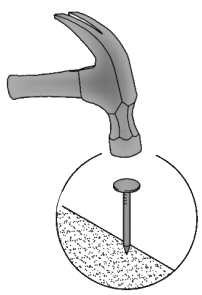
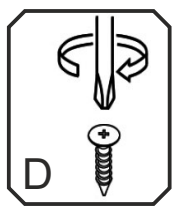
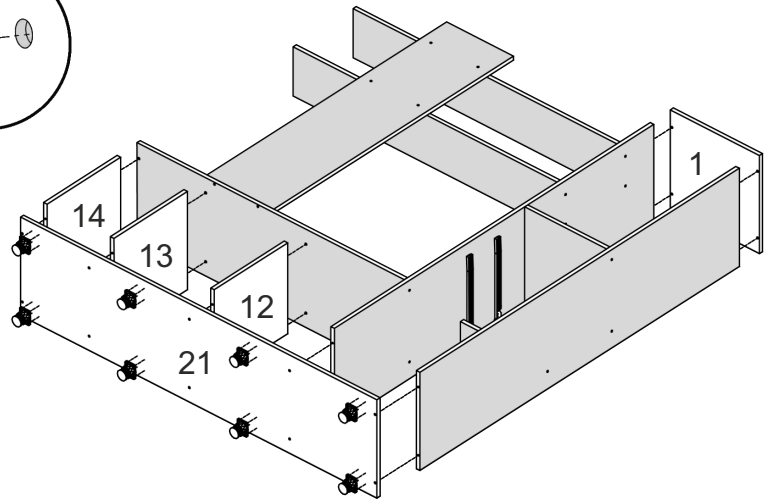
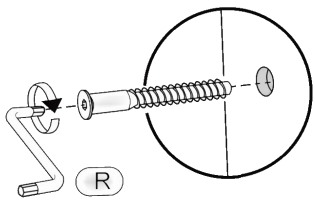





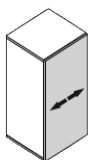
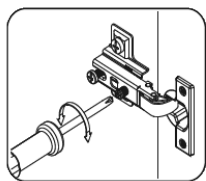
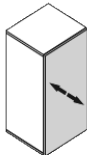
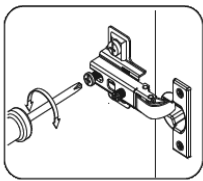
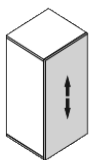
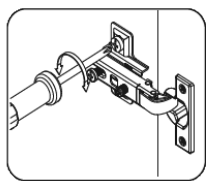
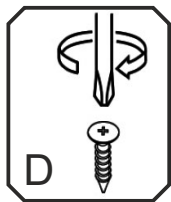
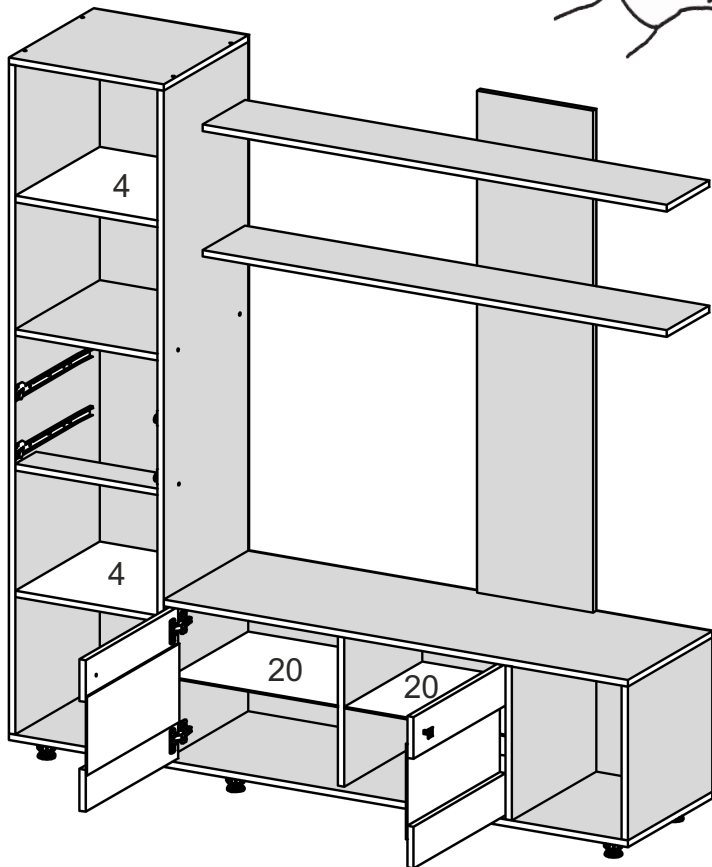
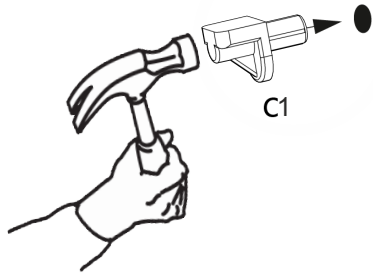
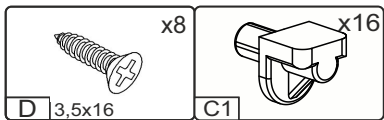

5

4.

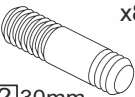

6

5. x2

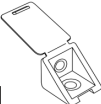
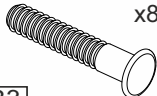
|   |  |  |   |
|---|--|--|---|
|  x2 |  x2  |  x8  |  x16 |
|    |  x2 |  x4 |  x8 |

