

4/2 and 4/3 Directional Control Valve, Solenoid Operated

RPE4-10

Size 10 (D05) • Q_{max} 140 l/min (37 GPM) • p_{max} 350 bar (5100 PSI)

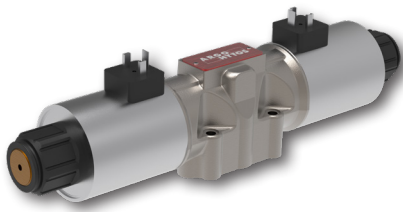

Technical Features

- › Direct acting directional control valve with subplate mounting interface acc. to ISO 4401, DIN 24340 (CETOP 05)
- › High transmitted hydraulic power up to 350 bar with optimized design to minimize pressure drop
- › Five chamber housing design with reduced hydraulic power dependence on fluid viscosity
- › The valve is available with interchangeable DC solenoids, also for AC power supply using a built-in rectifier bridge
- › Wide range of solenoid electrical terminal versions available
- › Wide range of interchangeable spools and manual overrides available
- › Inductive contactless Normally Open and Normally Closed spool position sensor option
- › Soft-shift spool speed control option
- › The coil is fastened to the core tube with a retaining nut and can be rotated by 90° to suit the available space.
- › In the standard version, the valve housing is phosphated and steel parts zinc-coated for 240 h salt spray protection acc. to ISO 9227. Enhanced surface protection for mobile sector available (ISO 9227, 520 h salt spray)

ISO 4401-05-04-0-05

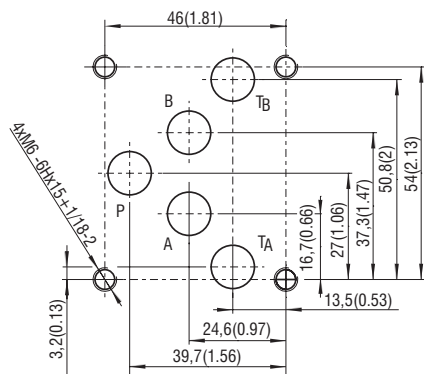

Ports P, A, B, T - max Ø11.2 mm (0.44 in)

Technical Data

Valve size		10 (D05)
Max. flow	l/min (GPM)	140 (37)
Max. operating pressure at ports P, A, B	bar (PSI)	standard 350 (5080)
Max. operating pressure at port T	bar (PSI)	210 (3050)
Fluid temperature range (NBR)	°C (°F)	-30 ... +80 (-22 ... +176)
Fluid temperature range (FPM)	°C (°F)	-20 ... +80 (-4 ... +176)
Ambient temperature range	°C (°F)	-30 ... +50 (-22 ... +122)
Supply voltage tolerance	%	AC: ±10 DC: ±10
Max. switching frequency	1/h	15 000
Switching time at v=32 mm ² /s (156 SUS)	ON	ms
	OFF	ms
Enclosure type acc. to EN 60529		IP65 / IP67 (see Dimensions, page 3)
Weight	- valve with 1 solenoid	kg (lbs)
	- valve with 2 solenoids	kg (lbs)
	Datasheet	Type
General information	GI_0060	Products and operating conditions
Coil types / connectors	C_8007 / K_8008	C31* / K*
Mounting interface	SMT_0019	Size 10
Spare parts	SP_8010	

Characteristics measured at v = 32 mm²/s (156 SUS)

Operating limits

Operating limits for maximum hydraulic power at rated temperature and supply voltage equal to 90% nominal.

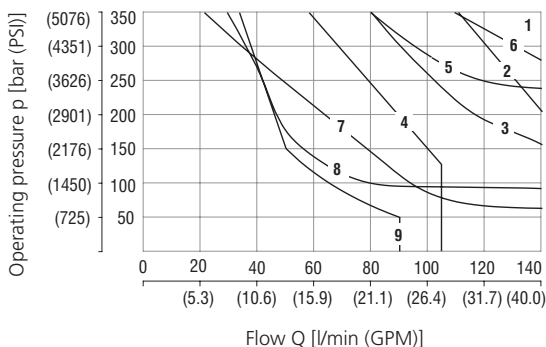

Spool symbol	1	2	3	4	5	6	7	8	9
Z11, Z51, H11, H51, P11, P51						J15, J75			
R11, X11, R21						L21			
C11, C51						A51			
B11, B51						C21			
Y11, Y51									

Pressure drop related to flow rate

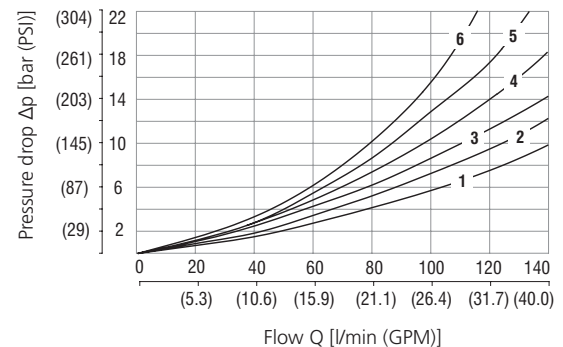

Spool symbol	P-A	P-B	A-T	B-T	P-T	P-A	P-B	A-T	B-T	P-T
Z11, P11, Y11, R11, X11, B11	1	1	2	2		C11	4	3	4	5
Z51, Y51, B51		1	2			C51	4			5
H11	1	1	2	2	1	L21	1	1	1	2
H51		1	2		1	R21	1	1	1	3
P51		1	2			J15	1	1	2	3
J75, A51	1	1				C21	6	6	6	6

For operating limits under conditions and flow directions other than shown contact our technical support. Admissible operating limits may be considerably lower with only one direction of flow (A or B plugged, or without flow.)

Ordering code

RPE4 - 10 [] [] / [] [] [] [] [] [] - []

4/2 and 4/3 directional control valve, solenoid operated

Valve size

Number of spool positions

two positions 2
three positions 3

Spool symbols

see the table "Spool Symbols"

Rated supply voltage of solenoids

(at the coil terminals)

12 V DC / 3.17 A 01200
24 V DC / 1.73 A 02400
27 V DC / 1.52 A 02700
205 V DC / 0.20 A 20500
120 V AC / 0.38 A / 60 Hz 12060
230 V AC / 0.20 A / 50 (60) Hz 23050

Connector

EN 175301-803-A E1
E1 with quenching diode E2
AMP Junior Timer - radial direction (2 pins; male) E3
E3 with quenching diode E4
EN 175301-803-A with integrated rectifier E5
Deutsch DT04-2P - axial direction (2 pins; male) E12A
E12A with quenching diode E13A

No designation

A zinc-coated (ZnCr-3), ISO 9227 (240 h)
B zinc-coated (ZnNi), ISO 9227 (520 h)

Surface treatment

standard

No designation

S1
S4

Spool monitoring

without sensors
normally-open sensor
normally-closed sensor

No designation
V

Seals

NBR
FPM (Viton)

Soft-shift spool speed control

No designation without soft-shift control
T0 with plugged cavity for optional soft shift installation
T2 orifice Ø0.6 mm (0.02 inch) in T line bridge
T3 adjustable needle valve in T line bridge

No designation

N1
N2
N4
N5
N9

Manual override

standard
cap nut covered
rubber boot protected
hand screw
socket head screw
without manual override

- For directional valves with two solenoids, one solenoid must be de-energized before the other solenoid can be charged.
- For AC voltage supply use coils with connector type E5.
- For other solenoid voltage supply options see datasheet C_8007.
- The solenoid operated valves are delivered without connectors. For available connectors see datasheet K_8008.

- The orifice to the P port can be ordered separately, see datasheet SP_8010.
- Mounting bolts M6 x 45 DIN 912-10.9 or studs must be ordered separately. Tightening torque is 14+1 Nm (10.3+0.7 lbf.ft).
- Besides the commonly used valve versions shown other special models are available. Contact our technical support for their identification, feasibility and operating limits. versions are available: consult our technical department for their identification, feasibility and operating limits.

Spool Symbols

Type	Symbol	Interposition	Type	Symbol	Interposition
Z11			P51		
C11			Y51		
H11			C51		
P11			Z51		
Y11			B51		
L21			H51		
B11			X11		
C21			C11		
R11			H11		
R21			J15		
A51			J75		

Type of Solenoid Coil in millimeters (inches)

E1, E2 Protection degree IP65	E3, E4 Protection degree IP67	E5 Protection degree IP65	E12A, E13A Protection IP67 / IP69K

The specified IP rating applies only in the case of correctly connected connectors (male + female) with the corresponding IP rating.

Manual Override in millimeters (inches)

No designation - standard	Designation N1 - cap nut covered	Designation N2 - rubber boot protected	Designation N4 - hand screw	Designation N5 - socket head screw size 3	Designation N9 - without manual override

In case of solenoid malfunction or power failure, the spool of the valve can be shifted by manual override as long as the pressure in port T does not exceed 25 bar (363 PSI). For alternative manual overrides contact our technical support.

Spool Position Sensor

S1 - Circuit diagram of the normally - **OPEN** sensor

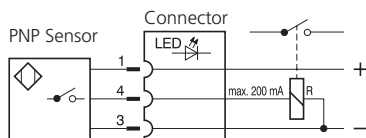

S4 - Circuit diagram of the normally - **CLOSED** sensor

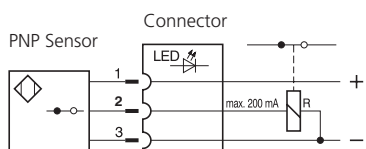

Function of the position sensor:

In the basic position (when the solenoid is switched off), a steel core, connected to the spool, is under the position sensor. The sensor is activated, it means contacts of the sensor S1 are closed and contacts of the sensor S4 are open. After switching on the solenoid the spool with core moves out of the sensor range and the sensor is deactivated.

Technical Data of the Sensor		S1, S4
Rated power supply voltage	V	24 DC
Power supply voltage range	V	10 ... 30 DC
Rated current	mA	200
Sensor enclosure protection (EN 60529)		IP67
Max. operating pressure	bar (PSI)	210 (3046)
Switching frequency	Hz	1000
Ambient temperature range	°C (°F)	-25 ... +80 (-13 ... +176)
Technical Data of the Connector		
Power supply voltage range	V	10 ... 30 DC
Ambient temperature range	°C (°F)	-25 ... +80 (-13 ... +176)
Indicator		yellow LED

Typical configurations of the valve with a sensor:

- 3-position valve with two solenoids, equipped with two sensors
 - 2-position valve with one solenoid, equipped with one sensor on the solenoid side
 - 2-position valve with a detent assembly of spool, equipped with one sensor on the side of the solenoid which moves the spool from the basic position to the switched position according to the spool symbol
- Note:** the sensor always indicates the change of spool position realised by the energised solenoid, mounted on the side of the sensor.

① Signal of solenoid	Two-Position Directional Control Valve			
	③ Signal of sensor	① a(b)	③ Sa(Sb)	LED
		S1	S4	S1 S4
0	1	0	ON	OFF
1	0	1	OFF	ON

Three-Position Directional Control Valve									
① a(b)		③ Sa(Sb)				LED			
		S1		S4		S1		S4	
a	b	Sa	Sb	Sa	Sb	Sa - LED	Sb - LED	Sa - LED	Sb - LED
0	0	1	1	0	0	ON	ON	OFF	OFF
1	0	0	1	1	0	OFF	ON	ON	OFF
0	1	1	0	0	1	ON	OFF	OFF	ON

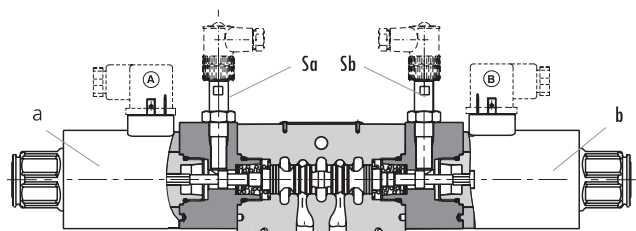
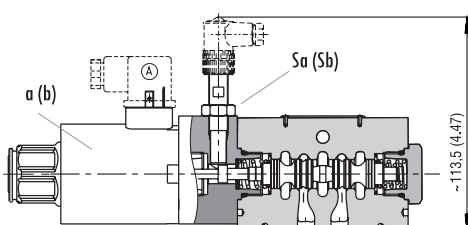

Spool Speed Control in millimeters (inches)

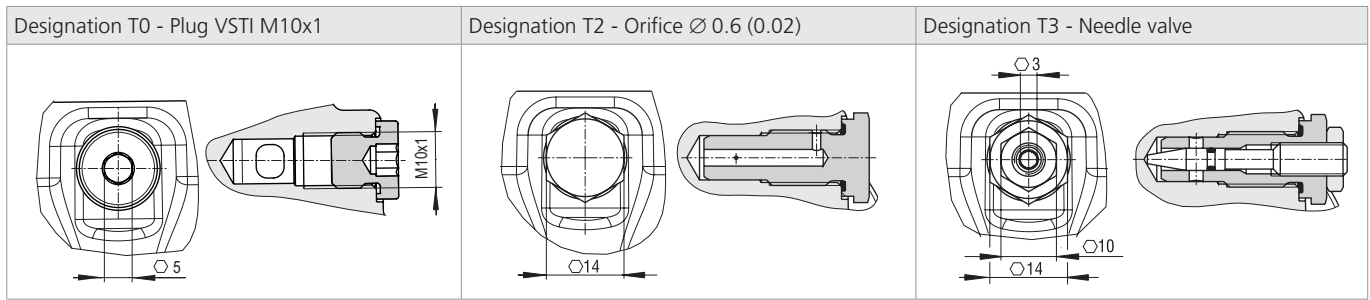

Plugged cavity for optional soft-shift control devices installation (T2, T3)	Switching time ON and OFF	The orifice extends the valve shifting time.	The needle valve allows continuous adjustment of the shifting time.
		120 ... 350 ms	30 ... 2000 ms

The switching times shown are valid for viscosity $\nu = 32 \text{ mm}^2/\text{s}$ (156 SUS) and nominal voltage. They depend on working pressure and flow rate of the directional control valve.

Dimensions in millimeters (inches)

Valve with two solenoids

RPE4-103*/*E1

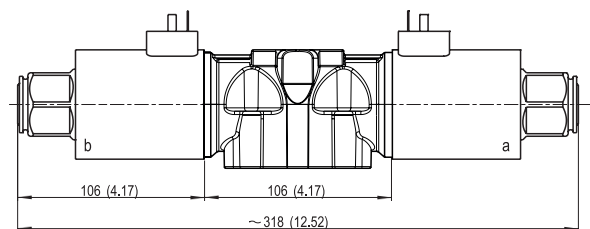
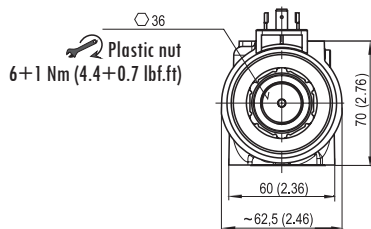

RPE4-103*/*E1*S

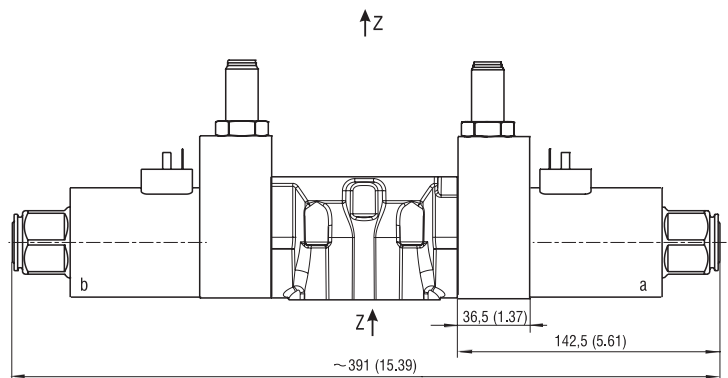
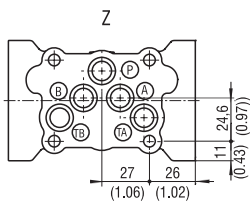

Valve with one solenoid „b“

Spool symbols X11, C11, H11

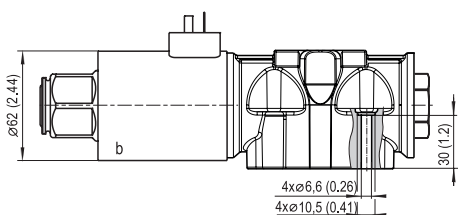

Valve with one solenoid „a“

Spool symbols R11, R21, A51, P51, Y51, C51, B51, Z51, H51

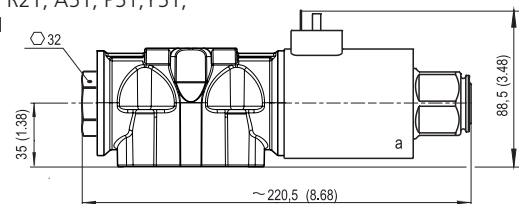

RPE4-102*/*E1*S

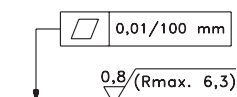
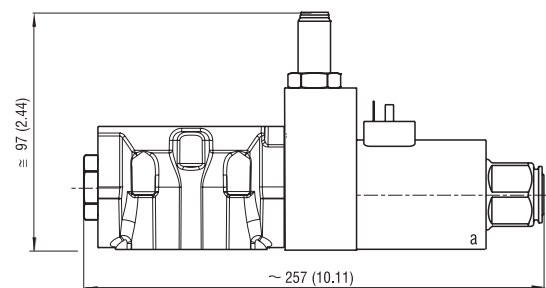
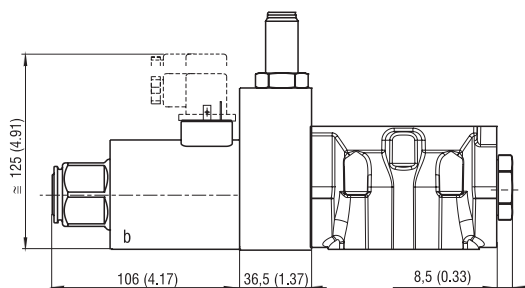

Required surface quality of the counterpart

Mounting screws 14+1 Nm (10.3+0.7 lbf.ft)
M6 x 45 DIN 912-10.9