

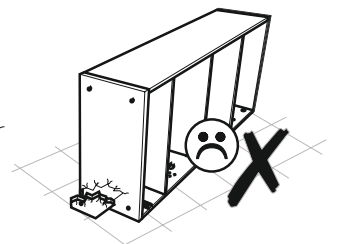

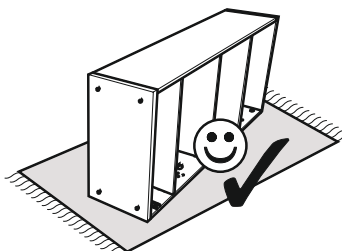

ПЕНАЛ

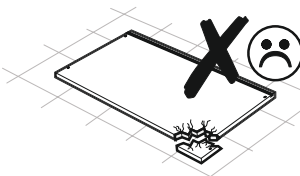
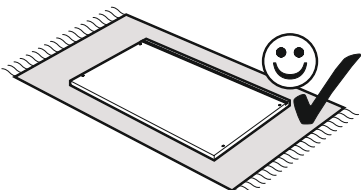
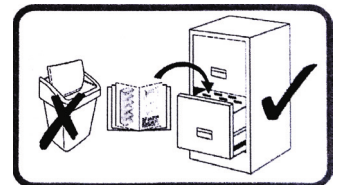
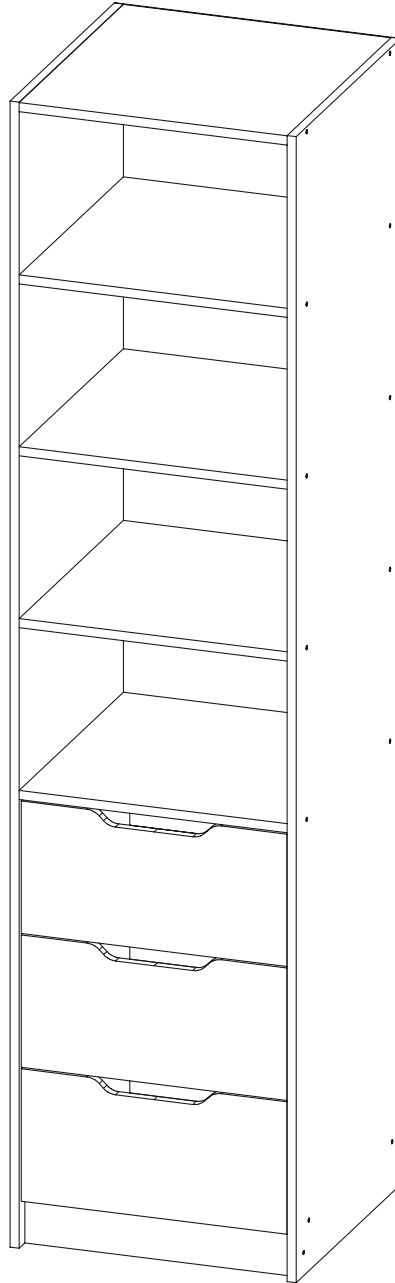
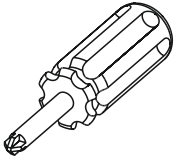
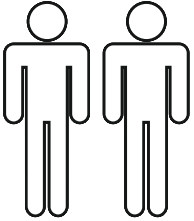
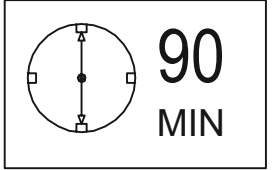

ІНСТРУКЦІЯ !

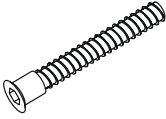
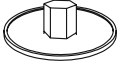

ПЕНАЛ

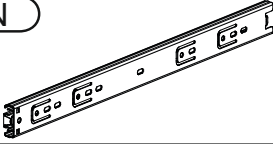
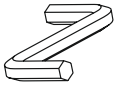
 <p>B1</p> <p>x38</p>	 <p>B03</p> <p>x38</p>	 <p>D0 3,0x15</p> <p>x80</p>
 <p>D1 3,5x16</p> <p>x24</p>	 <p>D2 3,5x30</p> <p>x6</p>	 <p>N L400</p> <p>x6</p>
 <p>Z</p> <p>x1</p>		

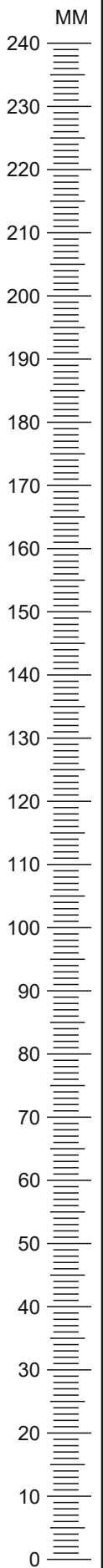

ПЕНАЛ

1	2000 x 500	1
2	2000 x 500	1
3	468 x 500	5
4	468 x 80	3
5	1920 x 495	1
6	150 x 445	6
7	150 x 409	6
8	440 x 440	3
9	230 x 463	3

x3

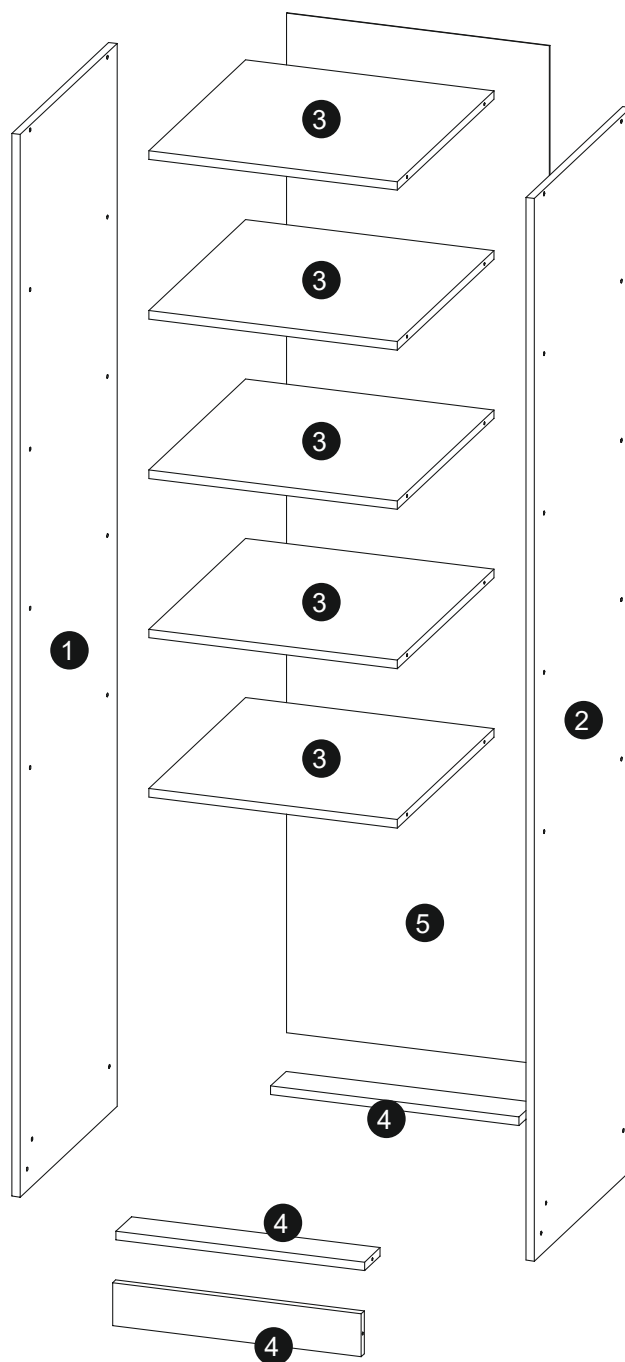
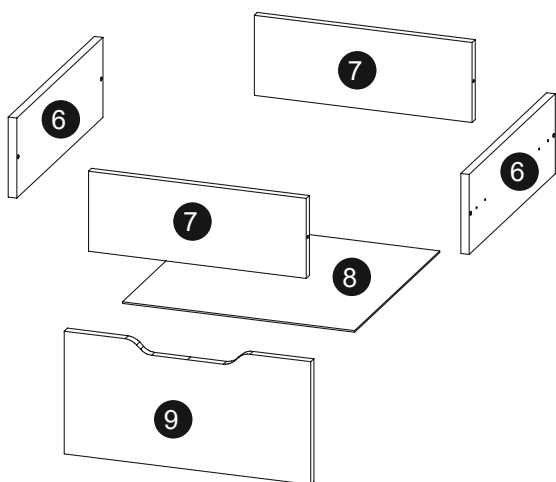

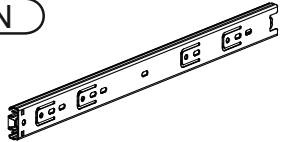

1

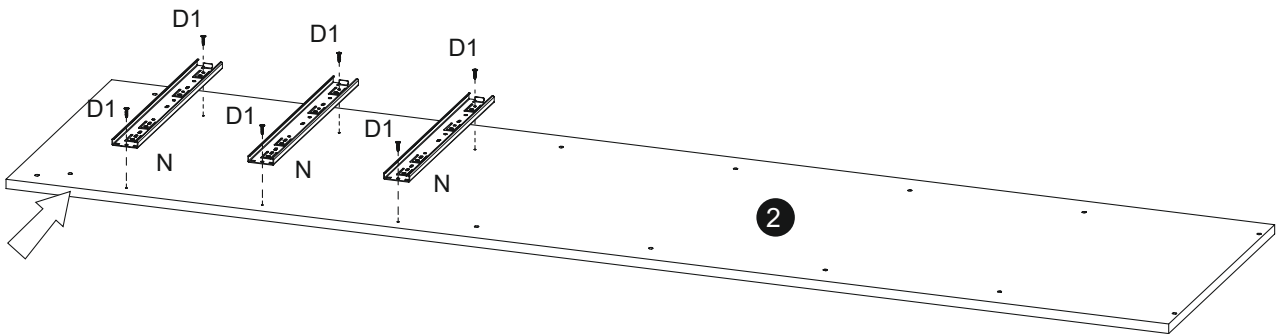
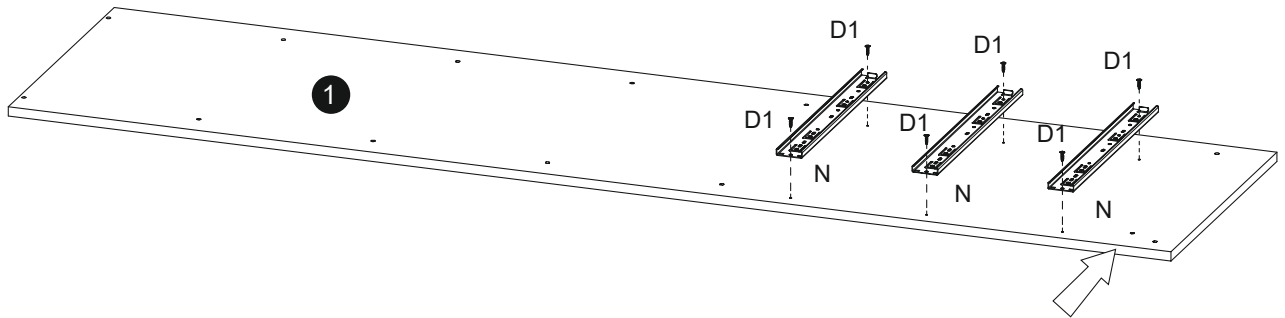
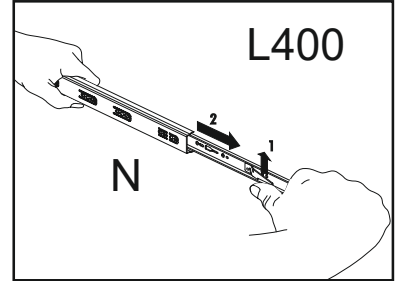
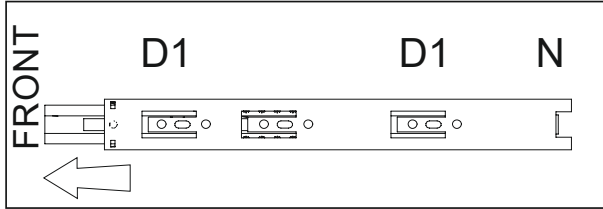
D1	3,5x16	N	L400
			
	x12		x6

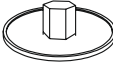

→ FRONT

2

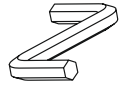
<p>B03</p>  <p>x26</p>	<p>B1</p>  <p>x26</p>	<p>Z</p>  <p>x1</p>
--	---	---

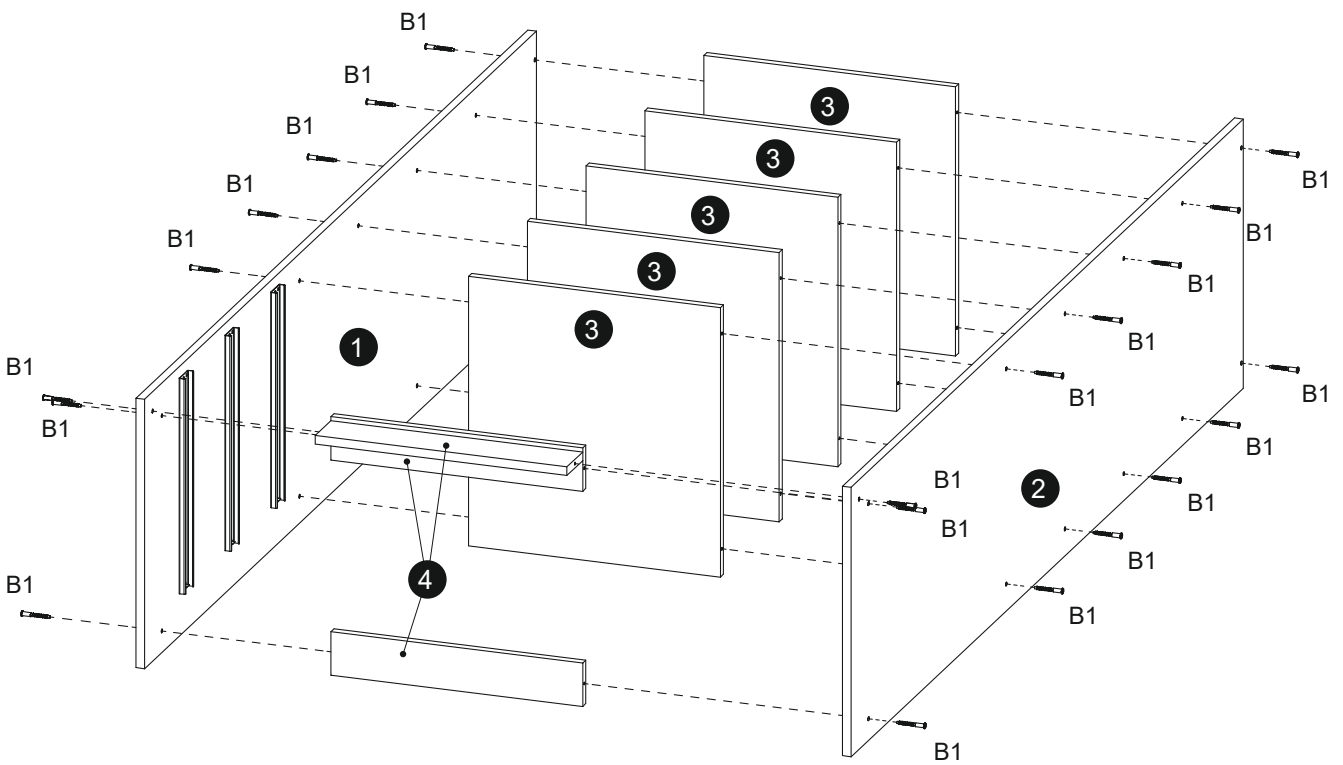
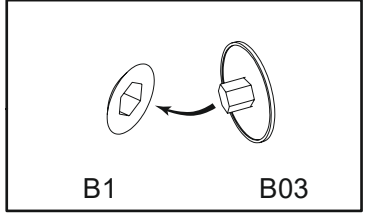
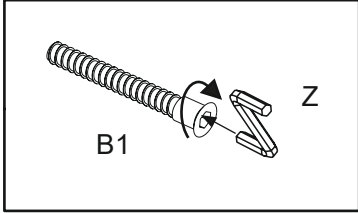



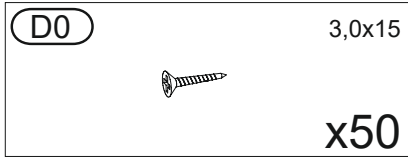

3

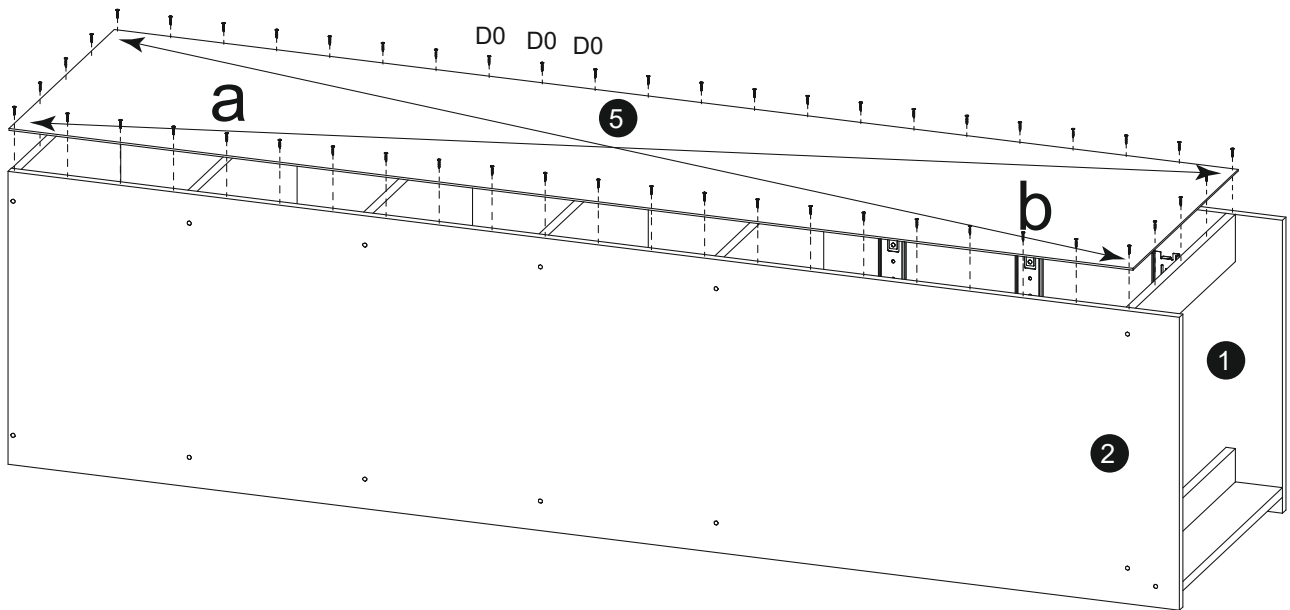

a=b

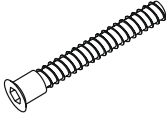
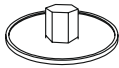

4

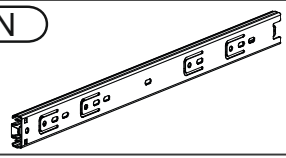
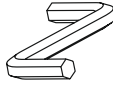
B1  x12	B03  x12	D0  3,0x15 x30
D1  3,5x16 x12	D2  3,5x30 x6	N  L400 x6
		Z  x1

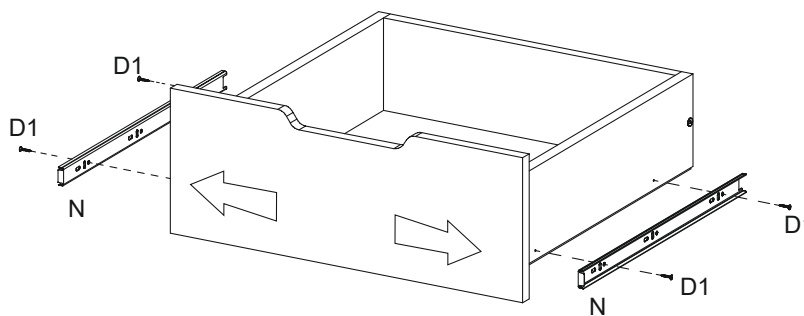
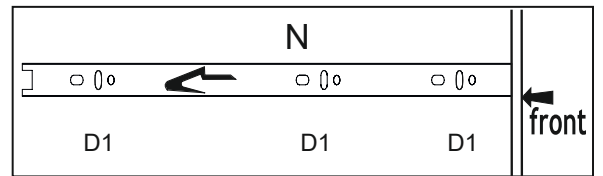
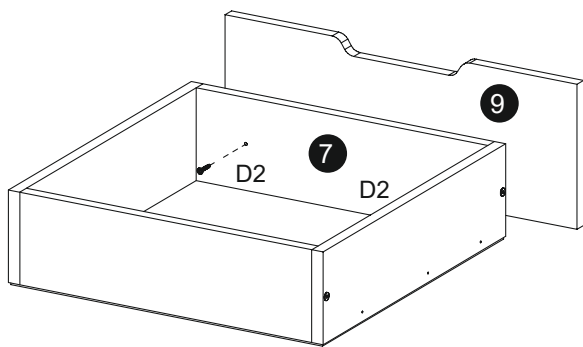
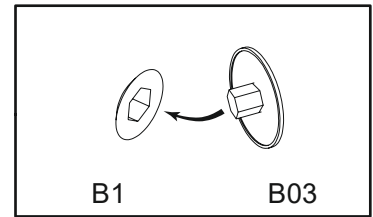
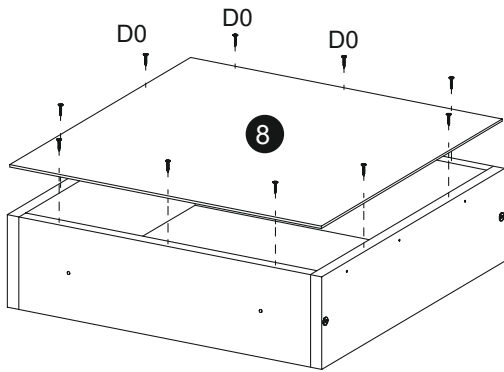
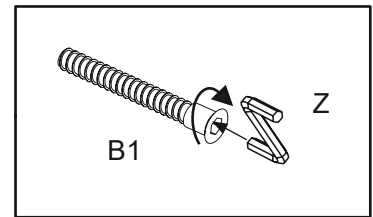
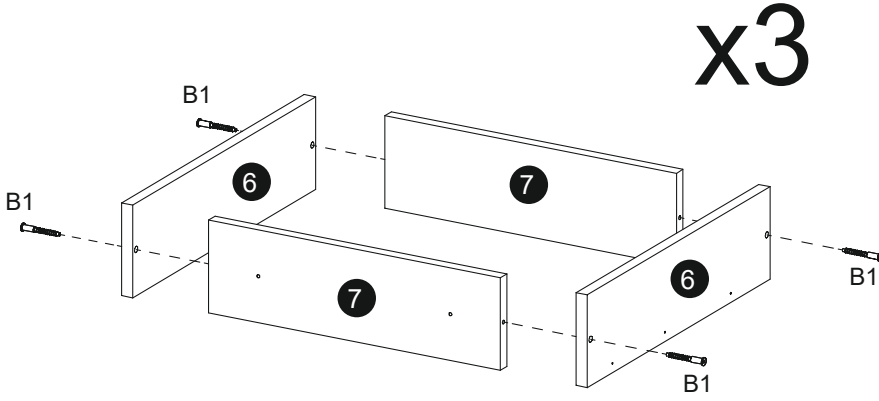

 **FRONT**

5

