

2.4G RC Dinosaur Climbing Car Instructions

1. About remote control

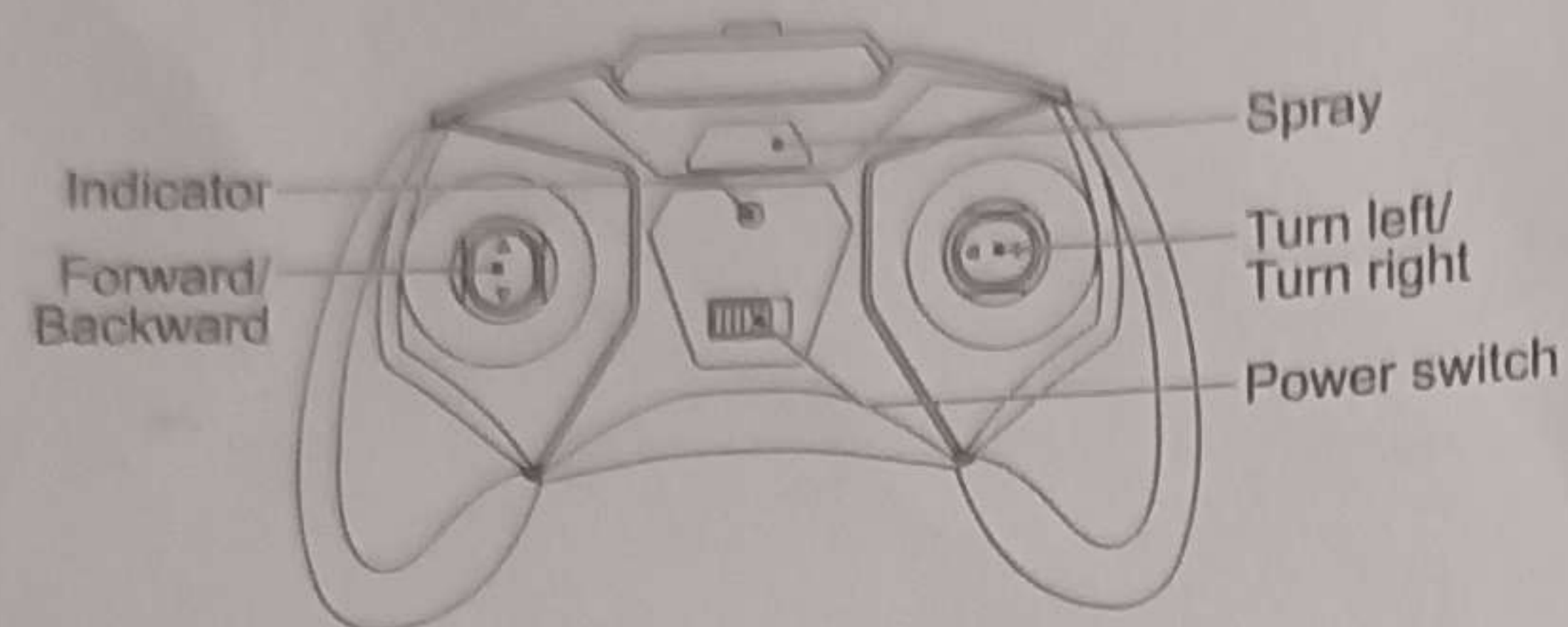

2. The pairing and battery installation for remote controller

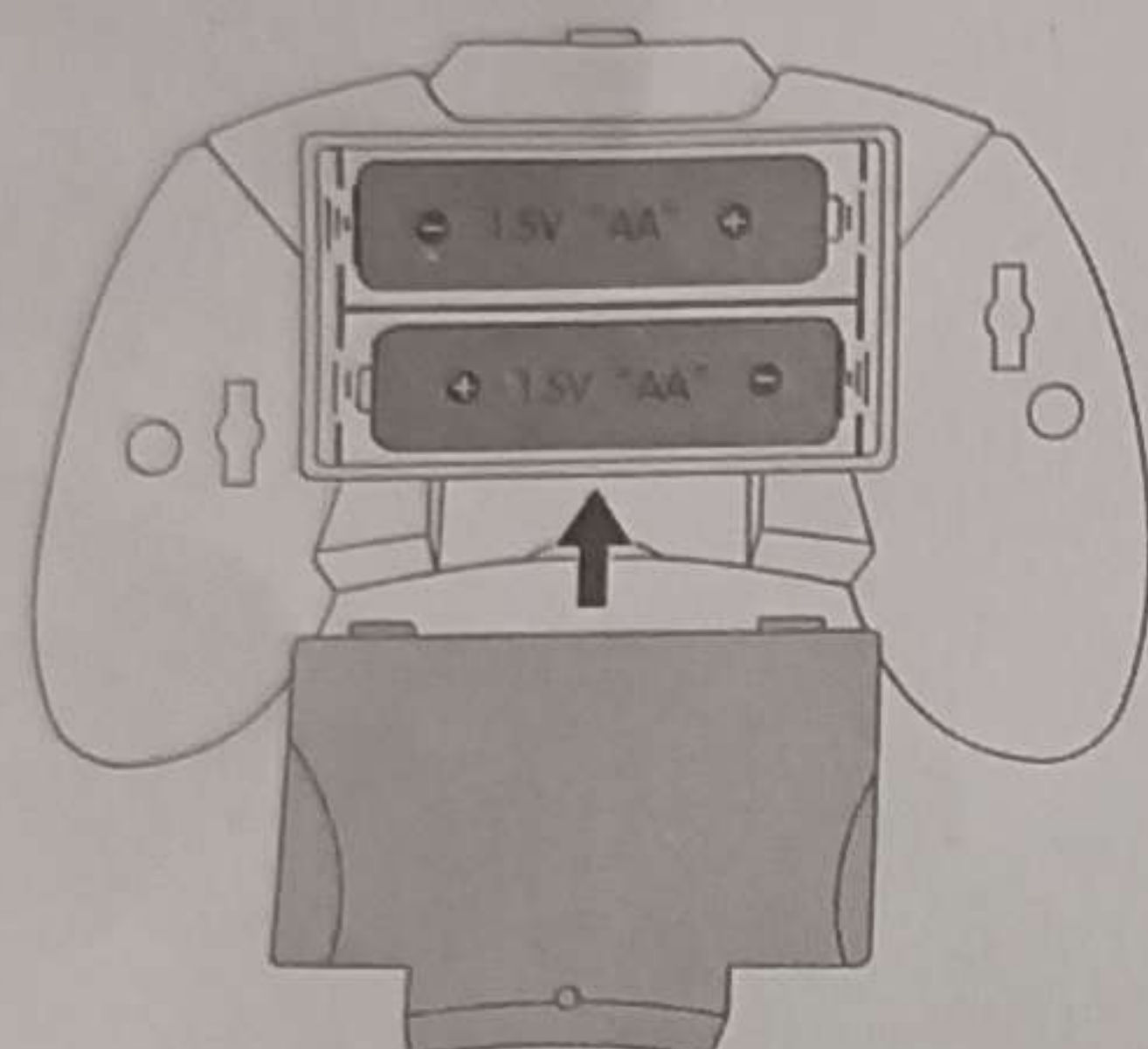

Remote control battery:
2x1.5V AA battery
(Battery not included)

The pairing of remote control:

First turn on the remote control. When the controller light is flashing, turn on the car, and then the light of remote is off, meaning the pairing is completed.

3. Car battery installation

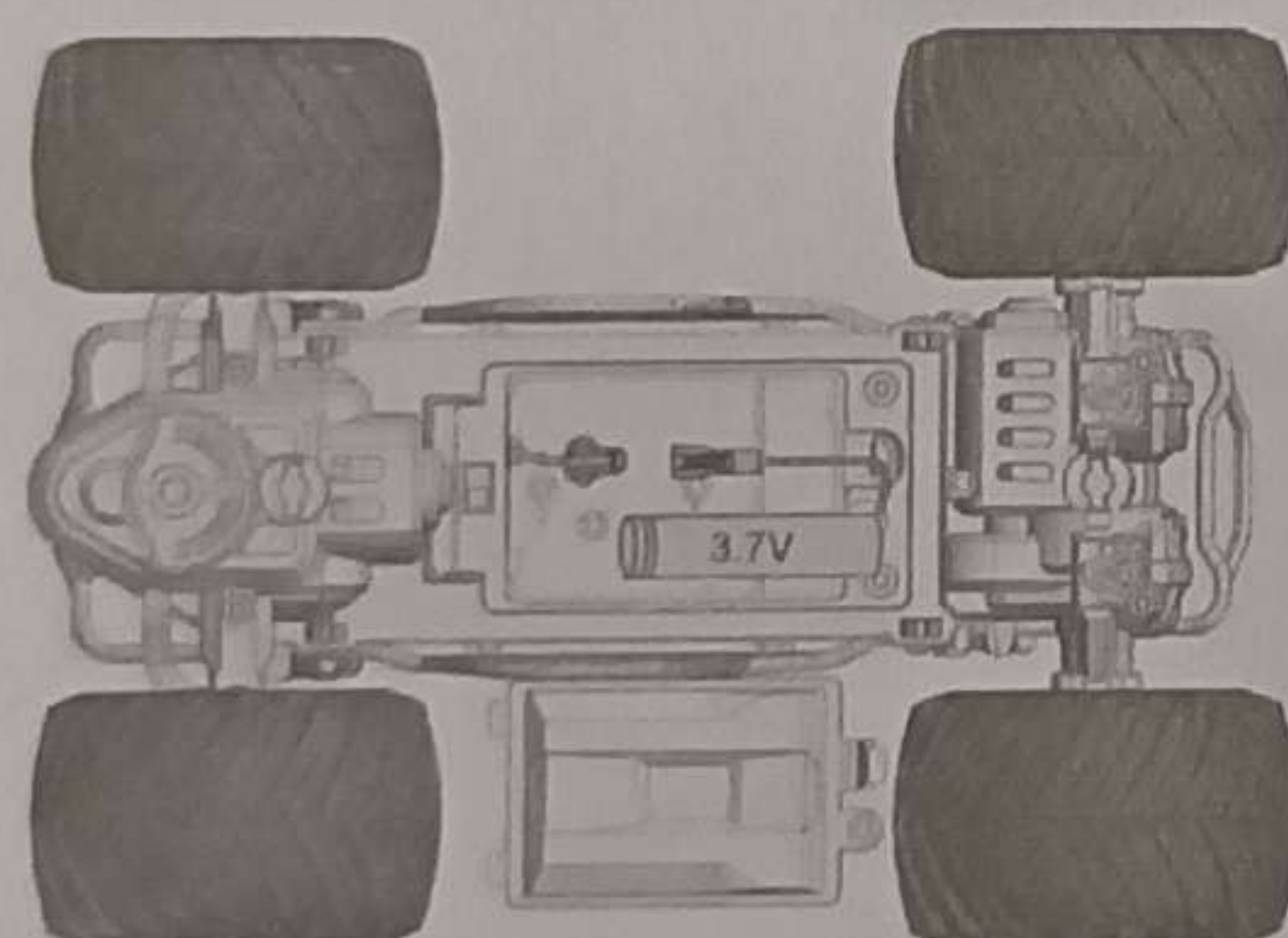

RC car (battery included)

Accessories:

1. USB charging cable
2. Rechargeable battery (included)

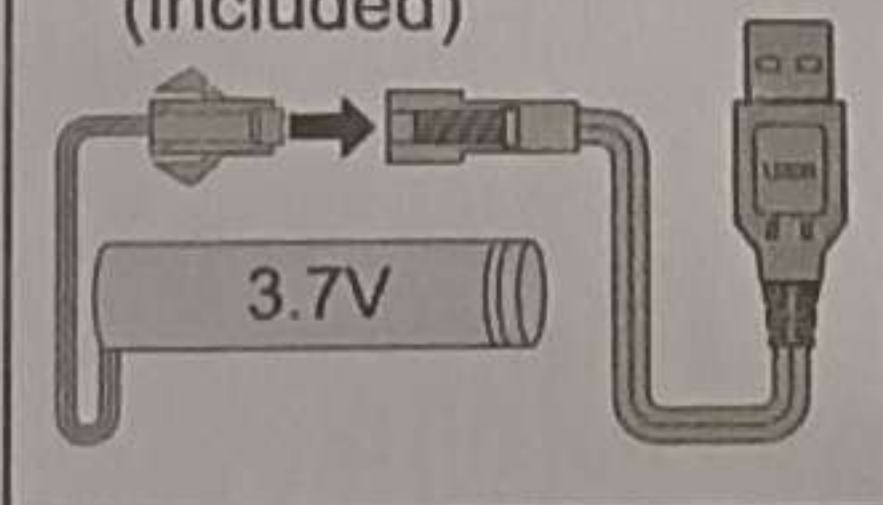

Note:

Remove the battery if you do not use it for a long time.

Attention for Charging via USB

1. Battery should be fully charged for the first time using. The battery will still self-discharge when not in use. If not in use for a long time, please ensure that the battery has about half of the power to prevent over discharge damage. Overcharging can shorten battery life.
2. Please regularly check the cord, plug, casing and other accessories and stop using before being repaired if any damages are found.
3. Do not connect the toys with the power that is not recommended. Charging conditions: Connect the USB smart charging cable with the original battery.
4. Please use appropriate adapter instead of fast charger for charging.
5. Please use the right adapter for charging. Input: 100-240V-50/60Hz 0.2A; output: 5.0V 500mA 0.5-1.5A.
6. Charging notes: To charge the battery, please connect the battery with smart USB charging cable, which has access to power media with USB interface, such as: desktop, laptop, mobile power, USB socket. Alternatively, you can use a USB adapter to connect with the power for charging.
7. Please remove the battery for the remote control truck and the remote controller if they are not expected to use for a long period of time.
8. When charging, the USB light is steady on. When fully charged, the light goes off.

*Please read through this manual before operation and keep it properly for future reference.

4. Remote control operation

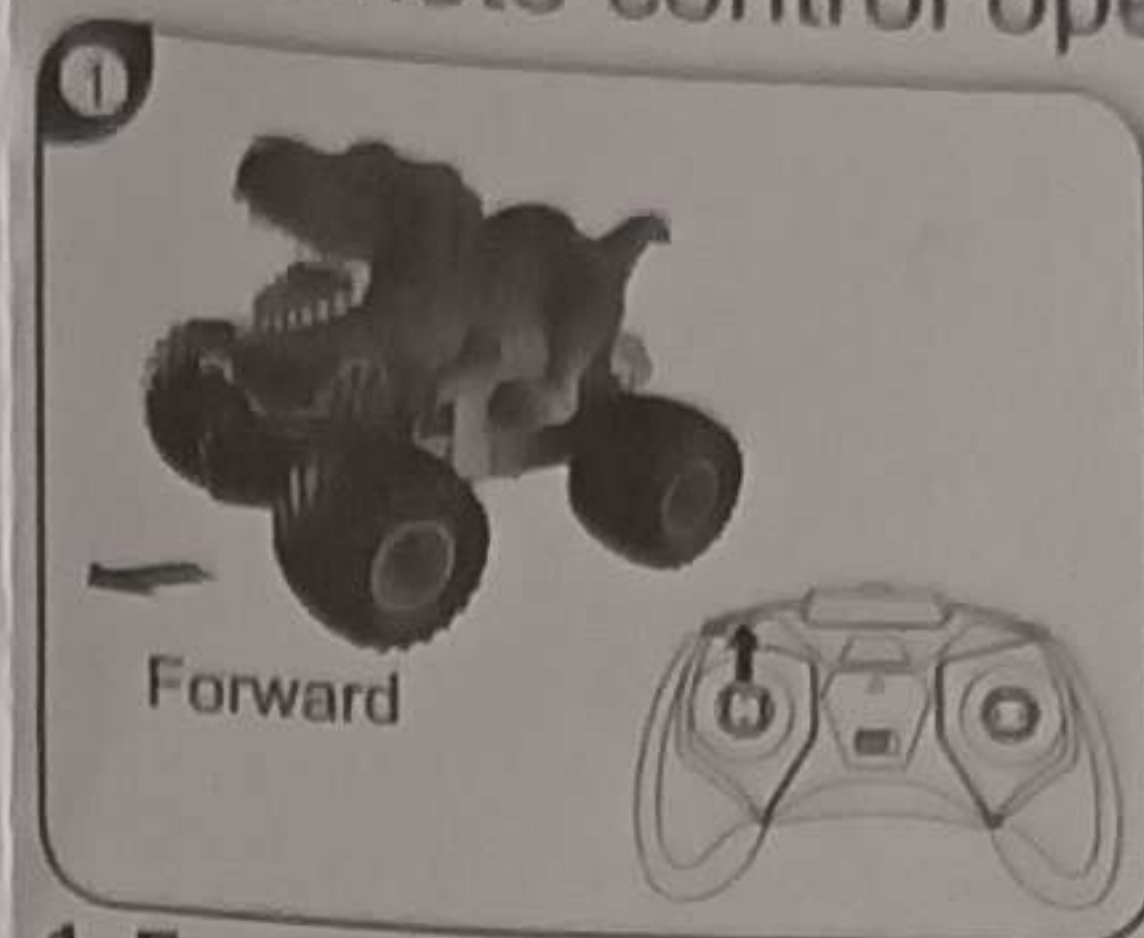

- 1. Forward**
Push left joystick forward to make the car go forward.



- 2. Backward**
Push left joystick backward to make the car go backward.

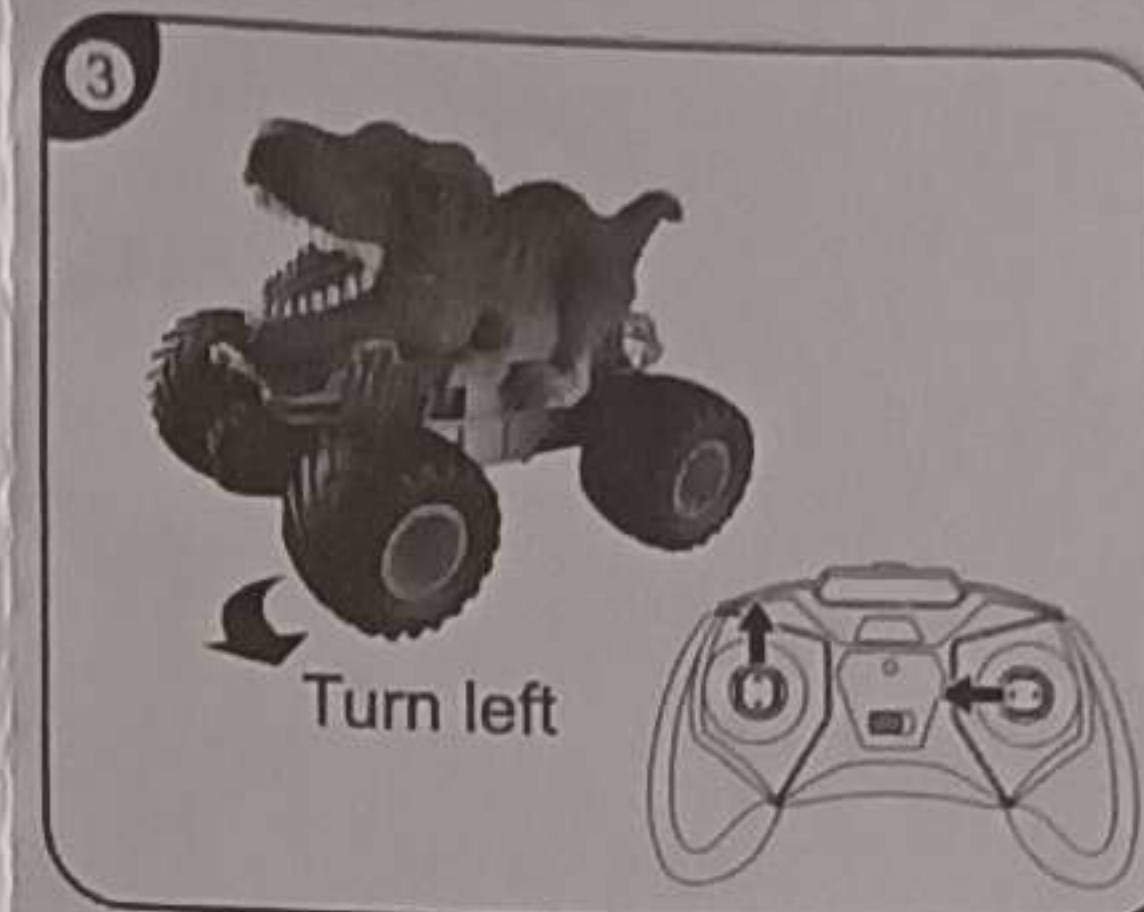

- 3. Turn left**
Push left joystick up and right joystick left to make the car turn left.

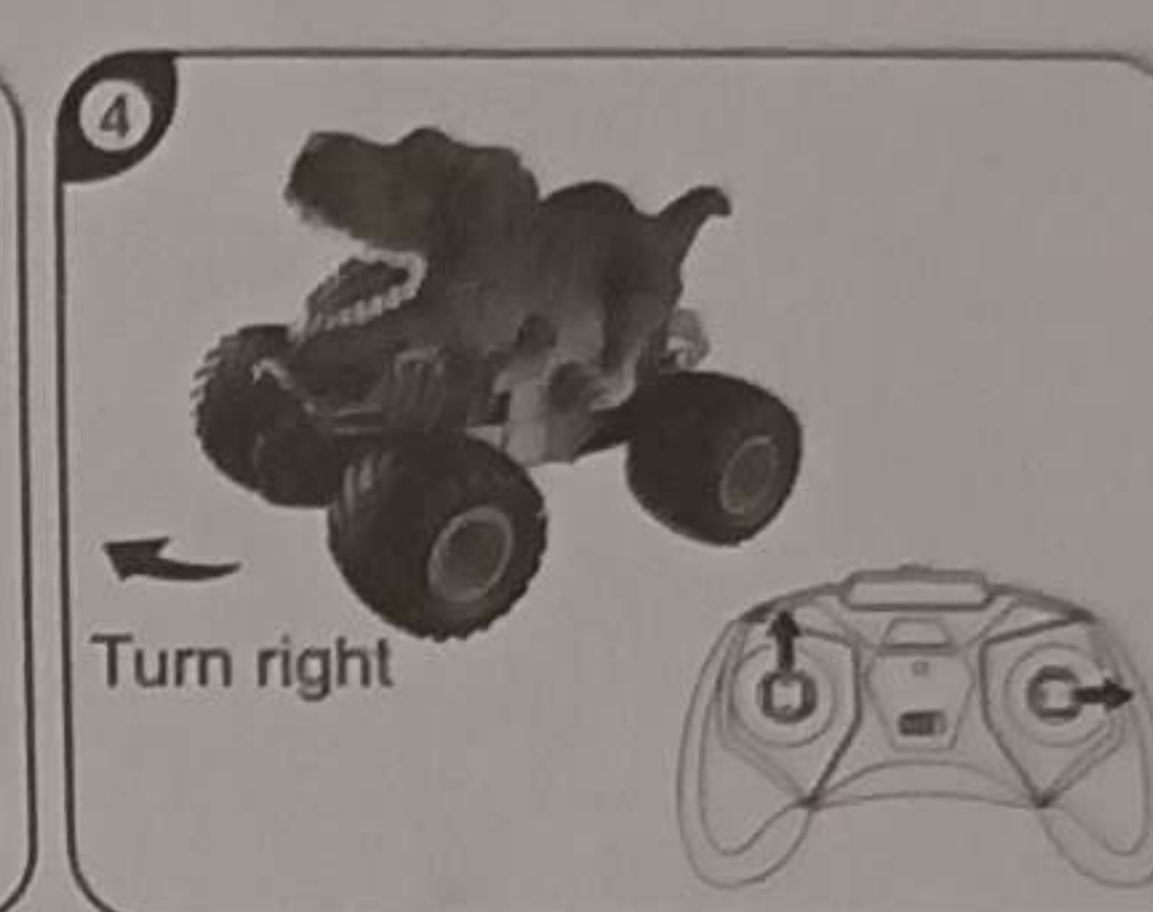

- 4. Turn right**
Push left joystick up and right joystick right to make the car turn right.

5. Spray

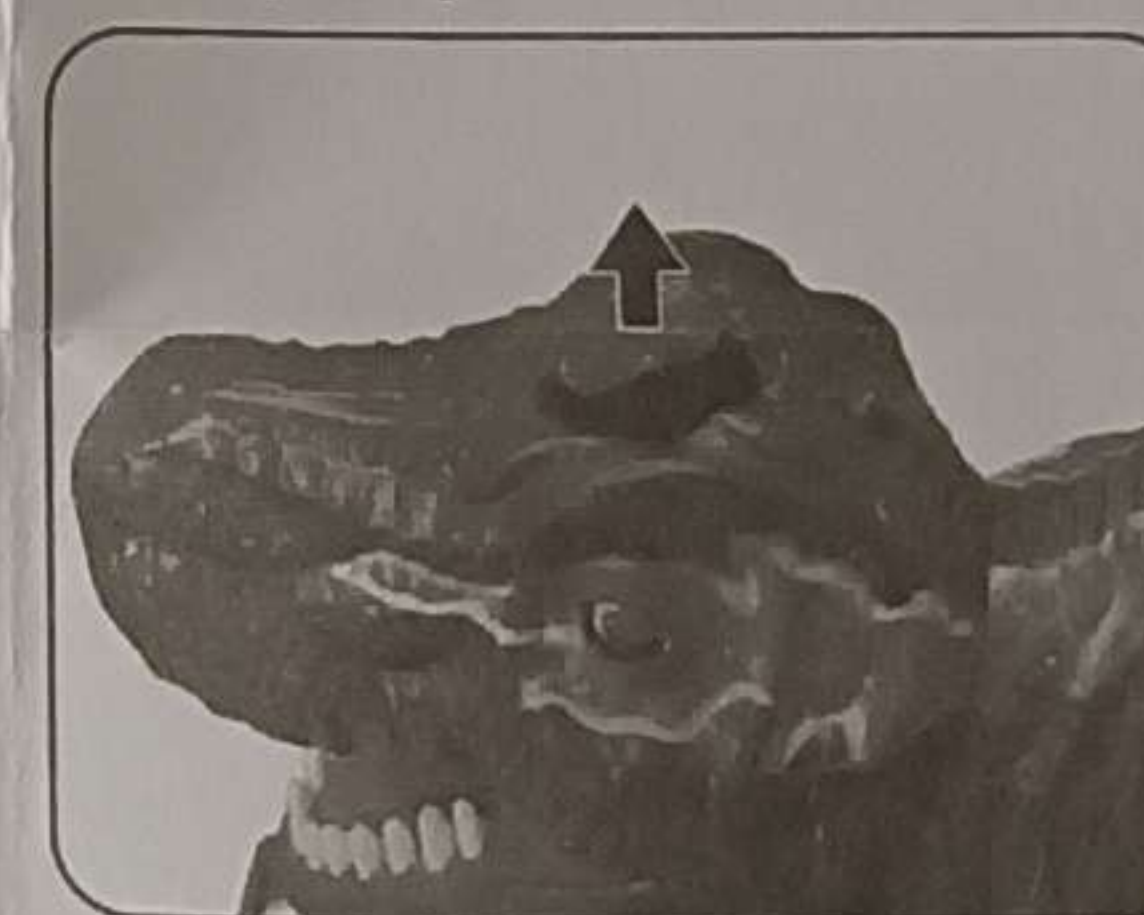

1. Open the dinosaur head cover of the remote control car.

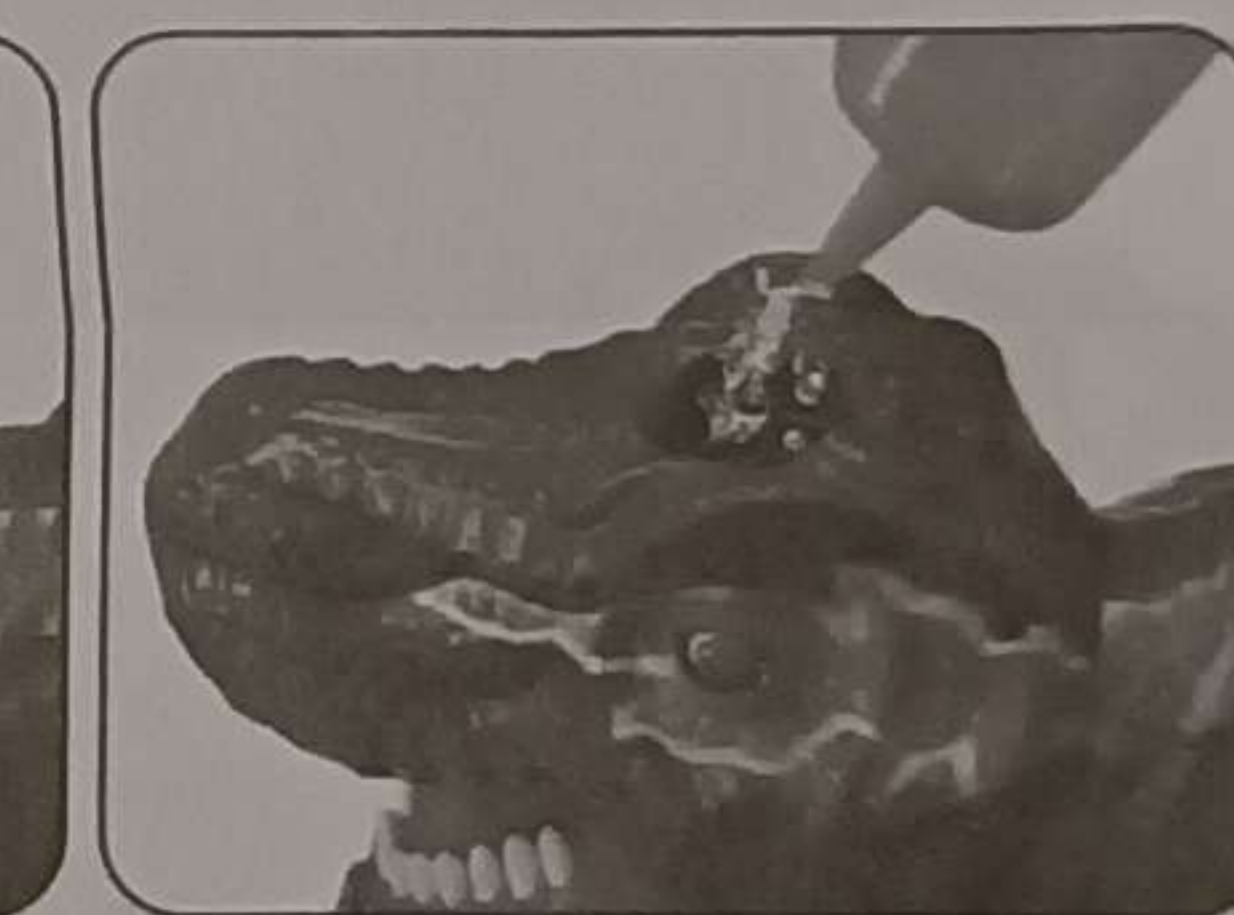

2. Inject 4-5 drops of water.

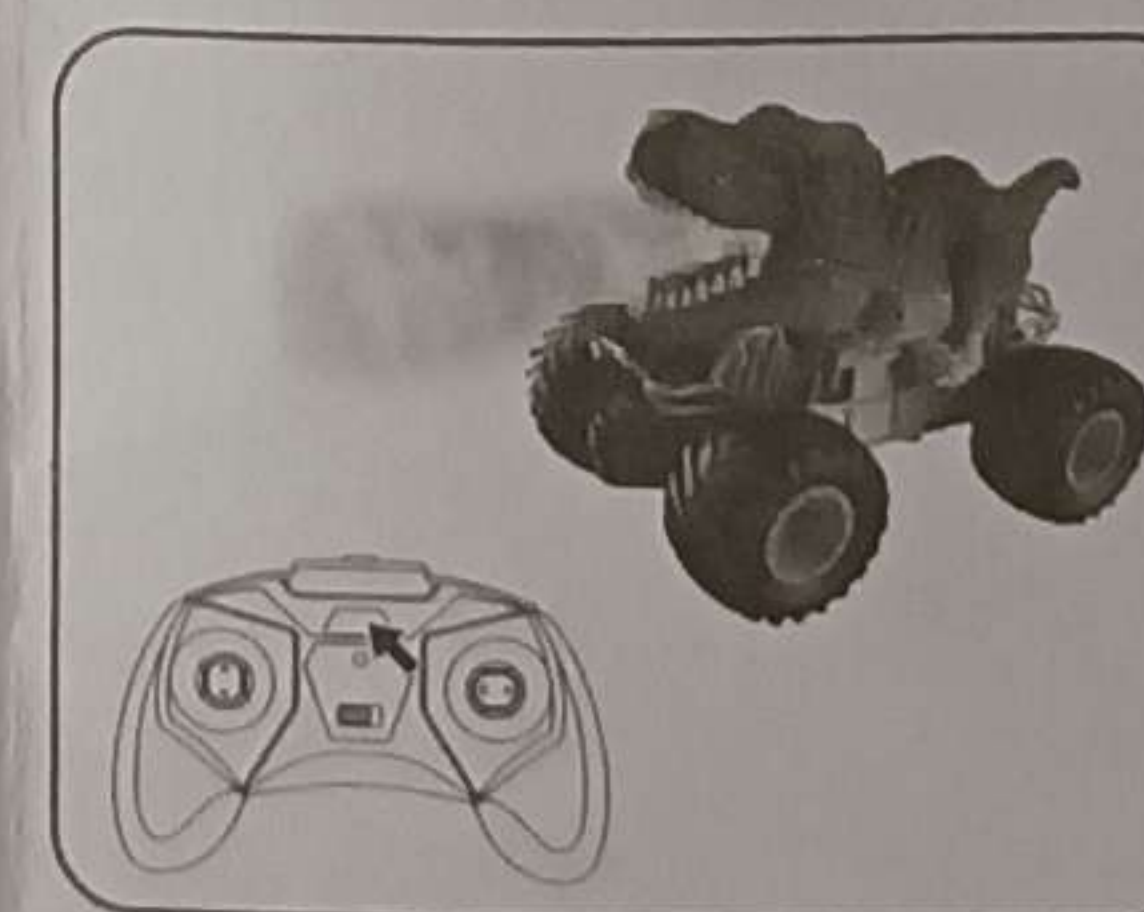

3. Press the spray button on the remote control and the car starts to spray.

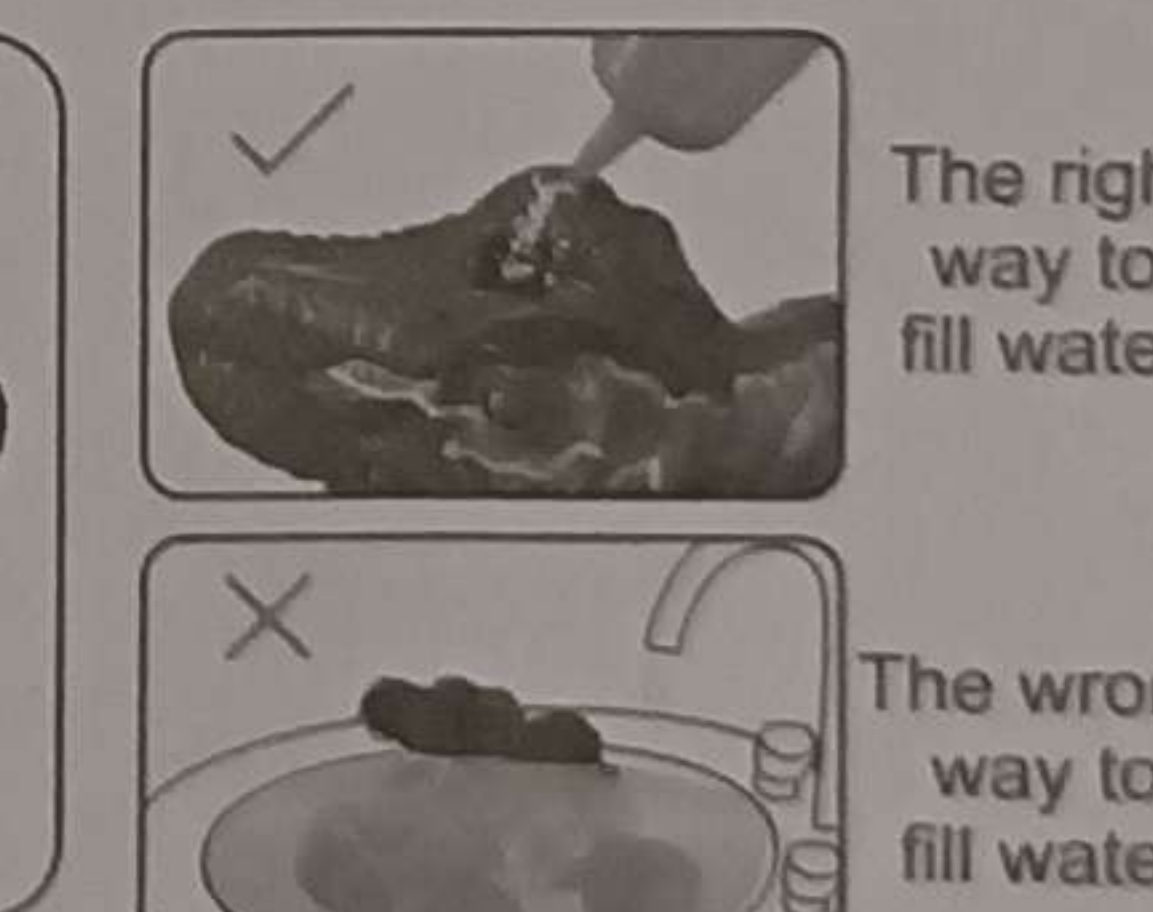

The right way to fill water

The wrong way to fill water

Note: When spraying, the spray sheet will be slightly hot. To avoid scalding, do not insert your finger into the spray nozzle.

Battery storage

1. Do not fully charge the battery before keeping it for a long time, otherwise it would result in the passivation, which speeds up the process of self-discharge.
2. Place the battery in dry indoor space with appropriate temperature between 10°C-30°C.
3. Conduct a charge cycle every other 3 months to keep it active and perform well.

