

FEATURES

- High breakdown voltage up to 650V for improved reliability
- Trench-Stop Technology offering :
 - High speed switching
 - High ruggedness, temperature stable
 - Short circuit withstand time – 5μs
 - Low V_{CEsat}
 - Easy parallel switching capability due to positive temperature coefficient in V_{CEsat}

V_{CE}	650	V
I_C	75	A
$V_{CE(SAT)} I_C=75A$	1.8	V

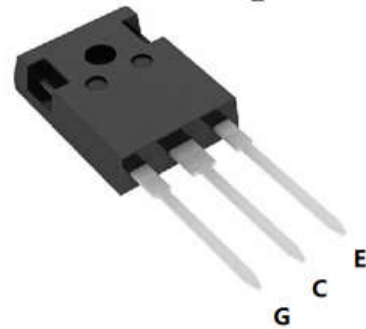
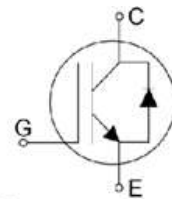

APPLICATION

- Uninterruptible Power Supplies
- Inverter
- Welding Converters
- PFC applications
- Converter with high switching frequency

Product	Package	Packaging
YGW75N65FP	TO247	Tube

Maximum Ratings ($T_j = 25^\circ\text{C}$ unless otherwise specified)

Parameter	Symbol	Value	Unit
Collector-Emitter Breakdown Voltage	V_{CE}	650	V
DC collector current, limited by $T_{j\max}$ $T_C = 25^\circ\text{C}$ $T_C = 100^\circ\text{C}$	I_C	150 75	A
Diode Forward current, limited by $T_{j\max}$ $T_C = 25^\circ\text{C}$ $T_C = 100^\circ\text{C}$	I_F	150 75	A
Continuous Gate-emitter voltage	V_{GE}	± 20	V
Transient Gate-emitter voltage	V_{GE}	± 30	V
Turn off safe operating area $V_{CE} \leq 650\text{V}$, $T_j \leq 175^\circ\text{C}$, $t_p = 1\mu\text{s}$	-	225	A
Pulse collector current, $V_{GE} = 15\text{V}$, t_p limited by $T_{j\max}$	I_{CM}	225	A
Short Circuit Withstand Time, $V_{GE} = 15\text{V}$, $V_{CE} \leq 400\text{V}$	T_{SC}	5	μs
Power dissipation, $T_j = 25^\circ\text{C}$	P_{tot}	500	W
Operating junction temperature	T_j	$-40 \dots +175$	$^\circ\text{C}$
Storage temperature	T_S	$-55 \dots +175$	$^\circ\text{C}$
Soldering temperature, wave soldering 1.6mm (0.063in.) from case for 10s	-	260	$^\circ\text{C}$
Mounting torque, M3 screw Maximum of mounting processes: 3	M	0.6	Nm

Thermal Resistance

Parameter	Symbol	Max. Value	Unit
IGBT thermal resistance, junction - case	$R_{\theta(j-c)}$	0.32	K/W
Diode thermal resistance, junction - case	$R_{\theta(j-c)}$	0.8	K/W
Thermal resistance, junction - ambient	$R_{\theta(j-a)}$	40	K/W

Electrical Characteristics ($T_j = 25^\circ\text{C}$ unless otherwise specified)

Parameter	Symbol	Conditions	Min	Typ	Max	Unit
Static						
Collector-Emitter Breakdown Voltage	BV_{CES}	$V_{GE}=0V, I_C=250\mu A$	650	-	-	V
Gate Threshold Voltage	$V_{GE(th)}$	$V_{GE}=V_{CE}, I_C=250\mu A$	4.0	4.9	6.0	V
Collector-Emitter Saturation Voltage	$V_{CE(sat)}$	$V_{GE}=15V, I_C=75A$ $T_j = 25^\circ\text{C}$ $T_j = 175^\circ\text{C}$	- -	1.8 2.3	2.2 -	V
Zero gate voltage collector current	I_{CES}	$V_{CE} = 650V, V_{GE} = 0V$ $T_j = 25^\circ\text{C}$ $T_j = 175^\circ\text{C}$	- -	0.1 -	100 5000	μA
Gate-emitter leakage current	I_{GES}	$V_{CE} = 0V, V_{GE} = \pm 20V$	-	-	200	nA
Transconductance	g_{fs}	$V_{CE} = 20V, I_C = 75A$	-	45	-	S

Parameter	Symbol	Conditions	Min	Typ	Max	Unit
Dynamic						
Input capacitance	C_{ies}	$V_{CE} = 25V, V_{GE} = 0V,$ $f = 1\text{MHz}$	-	4600	-	pF
Output capacitance	C_{oes}		-	250	-	
Reverse transfer capacitance	C_{res}		-	25	-	
Gate charge	Q_G	$V_{CC} = 520V, I_C = 75A,$ $V_{GE} = 15V$	-	130	-	nC
Short circuit collector current	$I_{C(SC)}$	$V_{GE}=15V, t_{SC} \leq 5\mu s$ $V_{CC}=400V,$ $T_{j, start}=25^\circ\text{C}$	-	590	-	A

Switching Characteristic, Inductive Load

Parameter	Symbol	Conditions	Min	Typ	Max	Unit
Dynamic $T_j=25^\circ\text{C}$						
Turn-on Delay Time	$t_{d(\text{on})}$	$V_{CC} = 400\text{V}, I_C = 75\text{A},$ $V_{GE} = 0/15\text{V},$ $R_g = 20\Omega$	-	75	-	ns
Rise Time	t_r		-	140	-	ns
Turn-off Delay Time	$t_{d(\text{off})}$		-	150	-	ns
Fall Time	t_f		-	75	-	ns
Turn-on Energy	E_{on}		-	5.0	-	mJ
Turn-off Energy	E_{off}		-	1.8	-	mJ

Electrical Characteristics of the DIODE ($T_j = 25^\circ\text{C}$ unless otherwise specified)

Parameter	Symbol	Conditions	Min	Typ	Max	Unit
Dynamic						
Diode Forward Voltage	V_{FM}	$I_F = 75\text{A}$	-	2.0	-	v
Reverse Recovery Time	T_{rr}	$I_F = 75\text{A},$ $V_R = 400\text{V},$ $di/dt = 600\text{A}/\mu\text{s},$	-	75	-	ns
Reverse Recovery Current	I_{rr}		-	15	-	A
Reverse Recovery Charge	Q_{rr}		-	665	-	nC

Fig. 1 Output characteristics

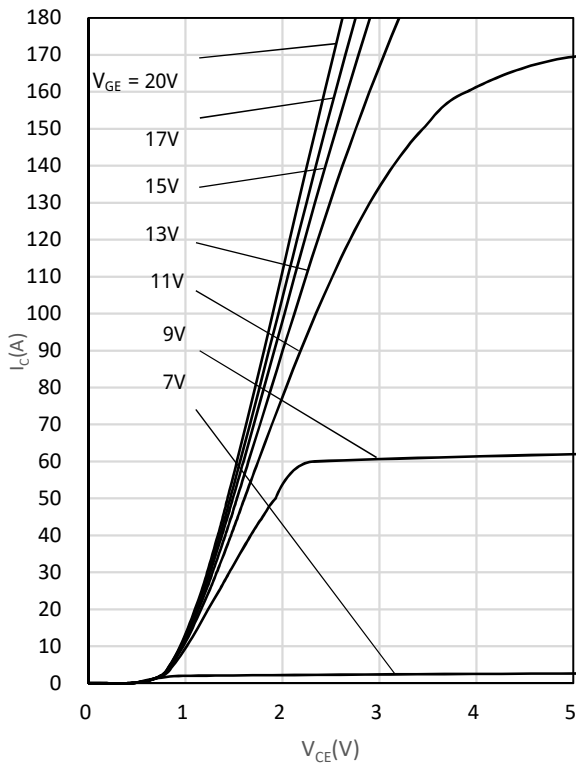

Fig. 2 Saturation voltage characteristics

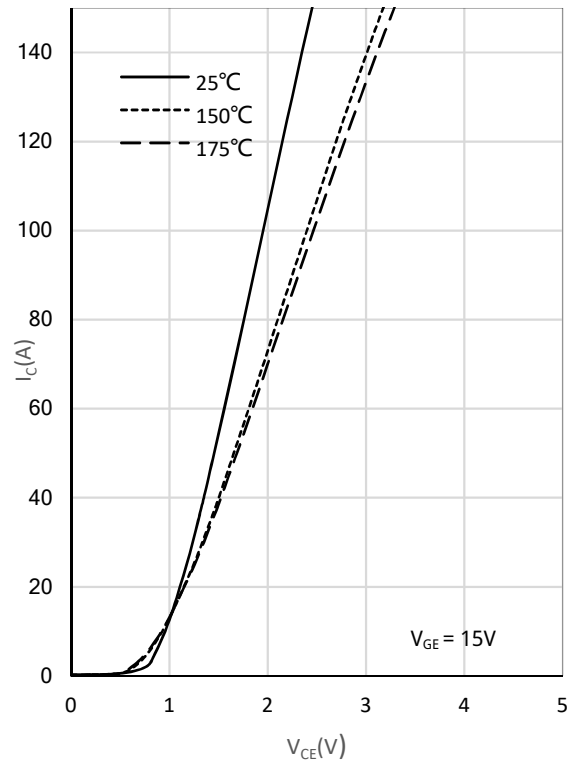

Fig. 3 Switching times vs. gate resistor

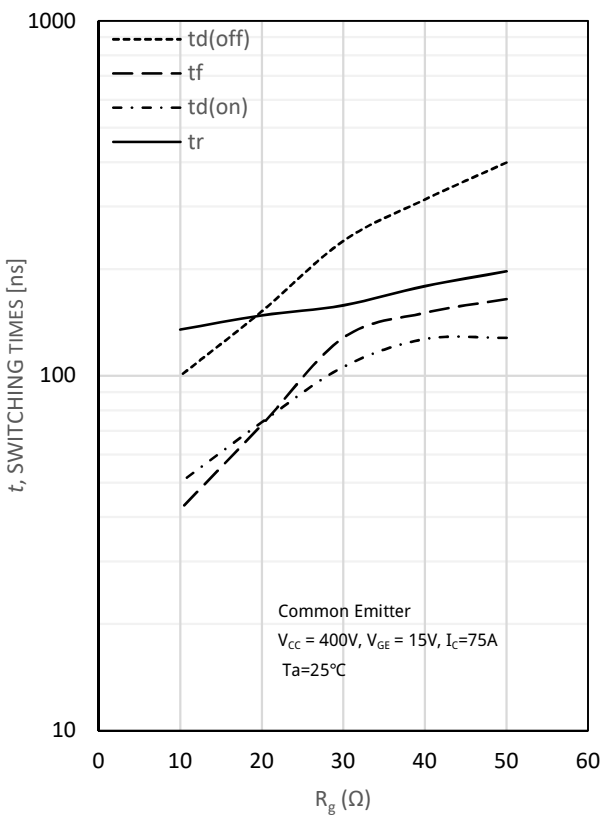

Fig. 4 Switching times vs. collector current

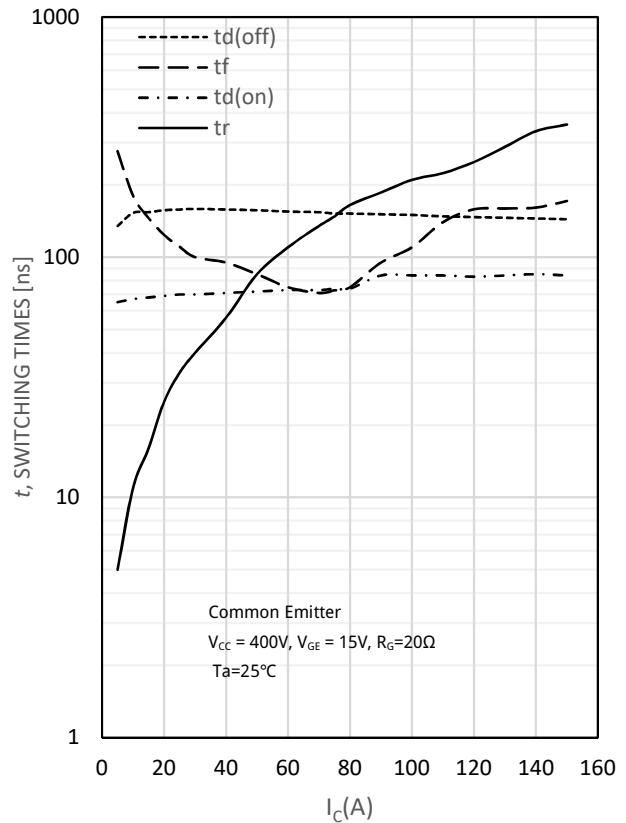

Fig. 5 Switching loss vs. gate resistor

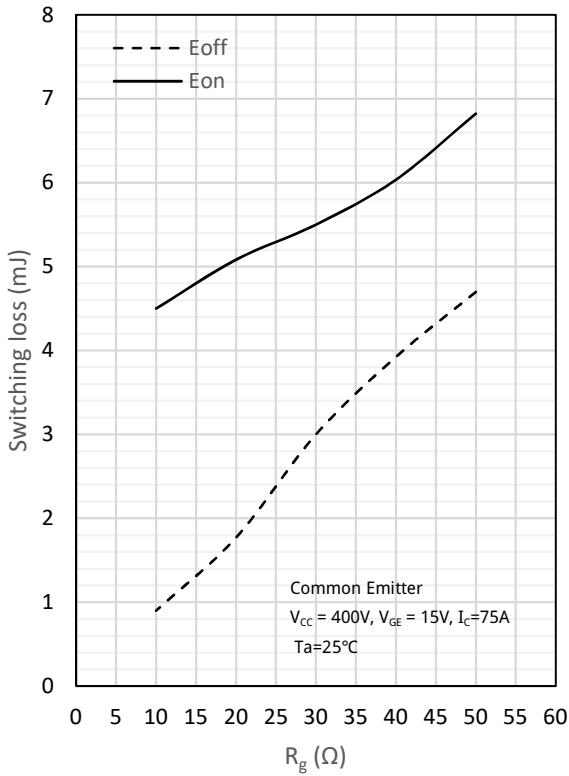

Fig. 6 Switching loss vs. collector current

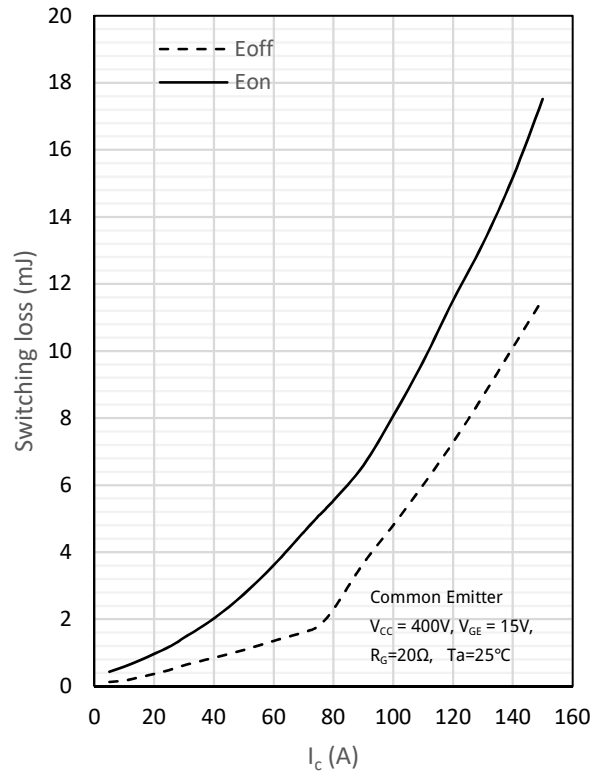

Fig. 7 Gate charge characteristics

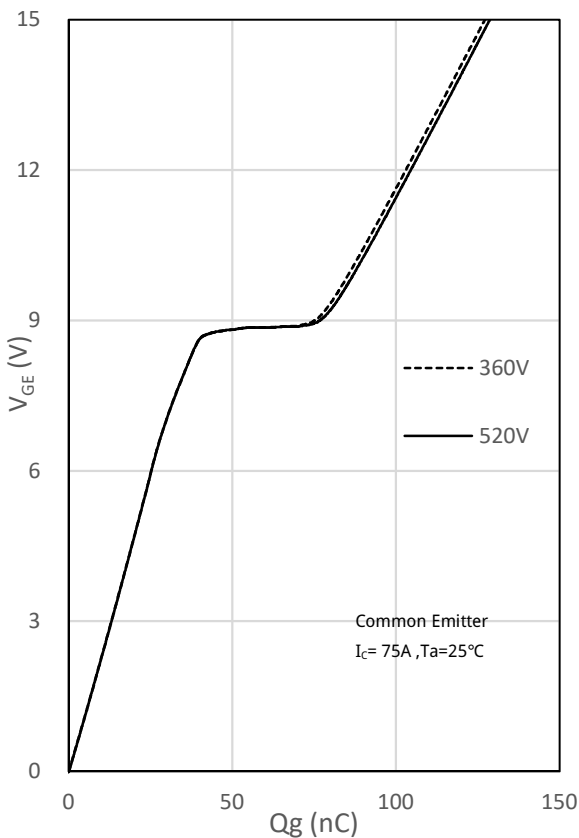
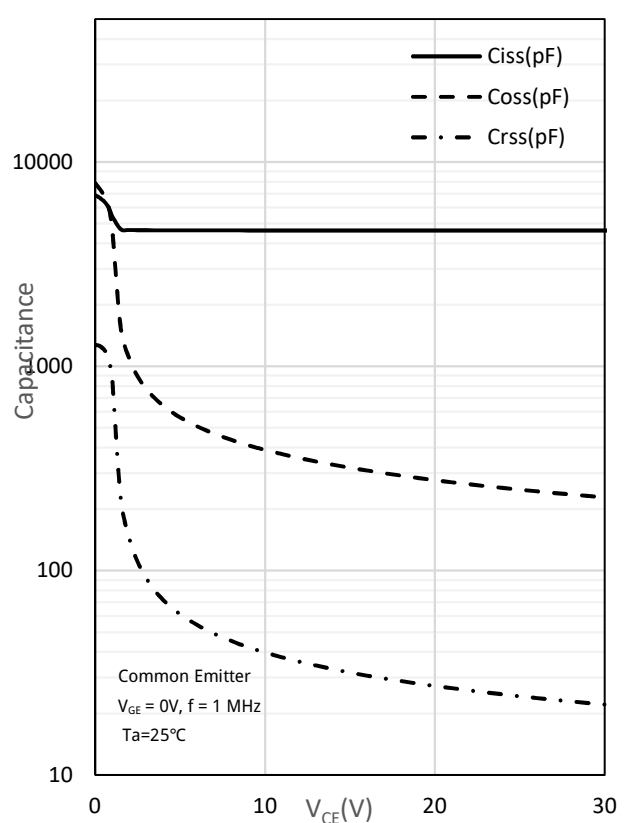
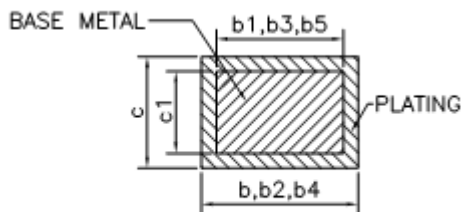
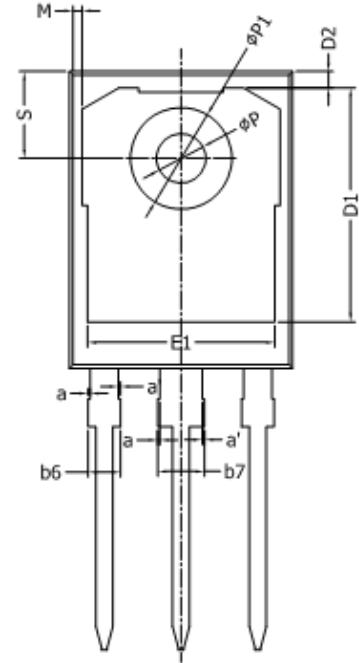
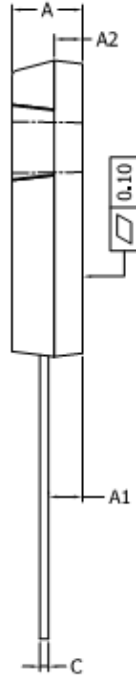
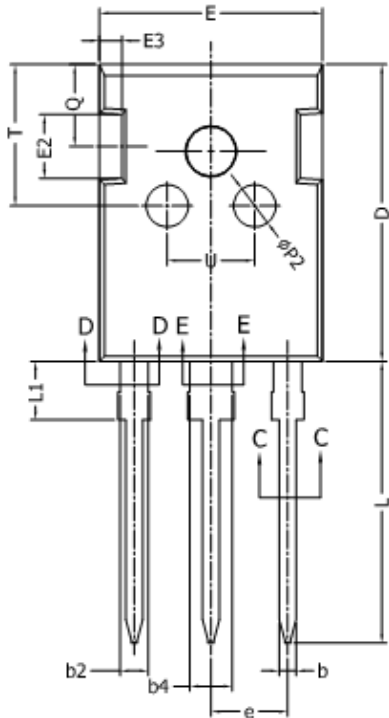

Fig. 8 Capacitance characteristics



TO247 package information



SECTION C-C, D-D & E-E

COMMON DIMENSIONS
(UNITS OF MEASURE =MILLIMETER)

SYMBOL	MIN	NOM	MAX
A	4.90	5.00	5.10
A1	2.31	2.41	2.51
A2	1.90	2.00	2.10
a	0	--	0.15
a'	0	--	0.15
b	1.16	--	1.26
b1	1.15	1.2	1.22
b2	1.96	--	2.06
b3	1.95	2.00	2.02
b4	2.96	--	3.06
b5	2.96	3.00	3.02
b6	2.00	--	2.25
b7	3.00	--	3.25
c	0.59	--	0.66
c1	0.58	0.60	0.62
D	20.90	21.00	21.10
D1	16.25	16.55	16.85
D2	1.05	1.17	1.35
E	15.70	15.80	15.90
E1	13.10	13.30	13.50
E2	4.40	4.50	4.60
E3	1.50	1.60	1.70
e	5.336	5.436	5.53
L	19.80	19.92	20.10
L1	4.10	--	4.30
M	0.35	--	0.95
P	3.40	3.50	3.60
P1	7.00	--	7.40
P2	2.40	2.50	2.60
Q	5.60	--	6.00
S	6.05	6.15	6.25
T	9.80	--	10.20
U	6.00	--	6.40