



**T0(3)-.../E,
T0(3)-.../EZ
T0(3)-.../E/SVB,
T0(3)-.../EA/SVB**

	T0...	T3...
	1 x 0.75 - 1.5 mm ² 2 x 0.75 - 1.5 mm ²	1 x 0.75 - 4.0 mm ² 2 x 0.75 - 4.0 mm ²
	1 x 1.0 - 2.5 mm ² 2 x 1.0 - 2.5 mm ²	1 x 1.0 - 6.0 mm ² 2 x 1.0 - 6.0 mm ²
tightening torque	1 Nm (8.85 lb-in) AWG18 - AWG14	1.6 Nm (14.16 lb-in) AWG14 - AWG10 2 Nm (17.7 lb-in)

T0(3)-.../E

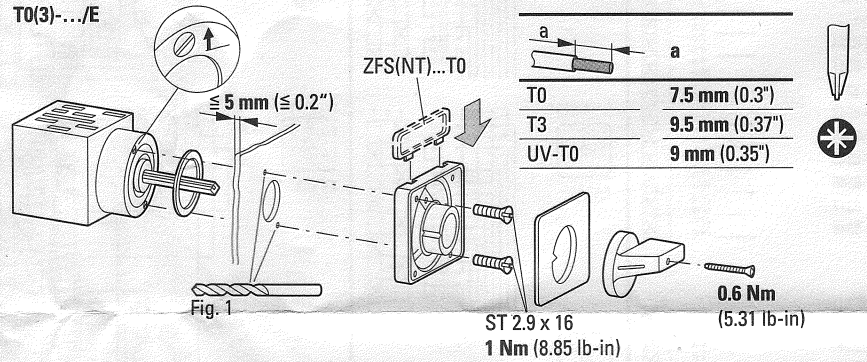

UL/CSA:

Suitable For Use As Motor Branch Circuit Disconnecting Means With Suffix SVB. Break All Lines.

Short Circuit Withstand
10 kA RMS SYM 600 V AC
Max Fuse T0... - 20 A Class J
T3... - 40 A Class J

Standard Short Circuit
5 kA RMS SYM 600 V AC
Max Fuse T0... - 50 A
T3... - 40 A
Max Cir. Bkr. T0... - 50 A
T3... - 125 A

Switch or enclosure must be padlockable if used as a Motor Branch Circuit Disconnecter means.

T0(3)-.../EZ/OFS
T0(3)-.../EZ

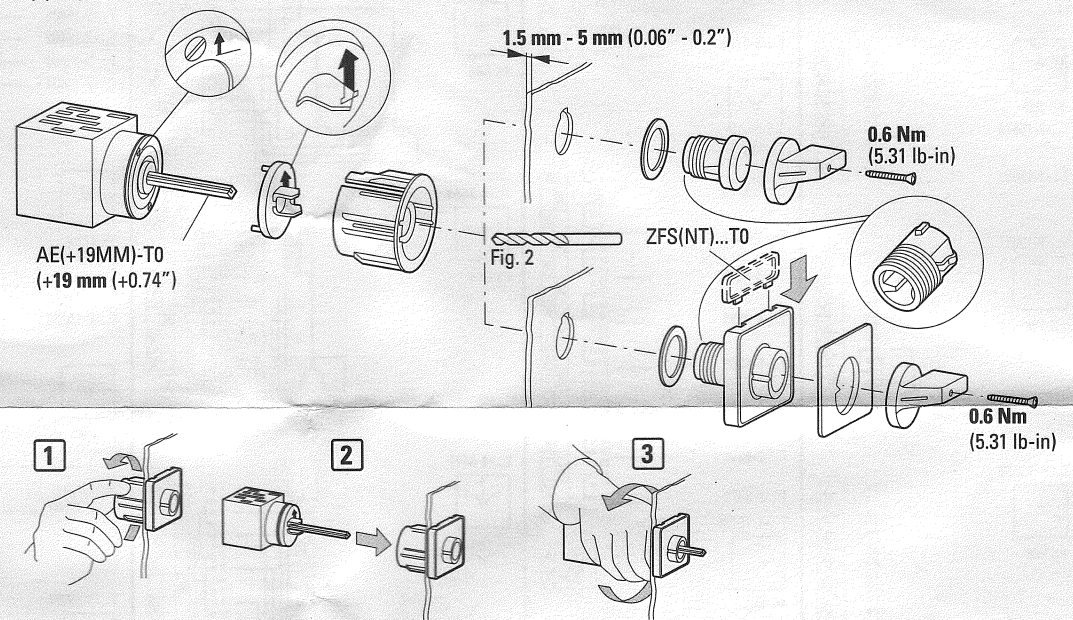

Fig. 1
→ * 1:1

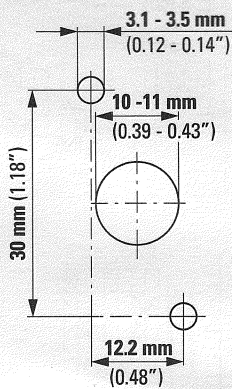
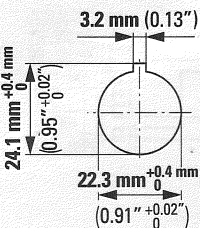
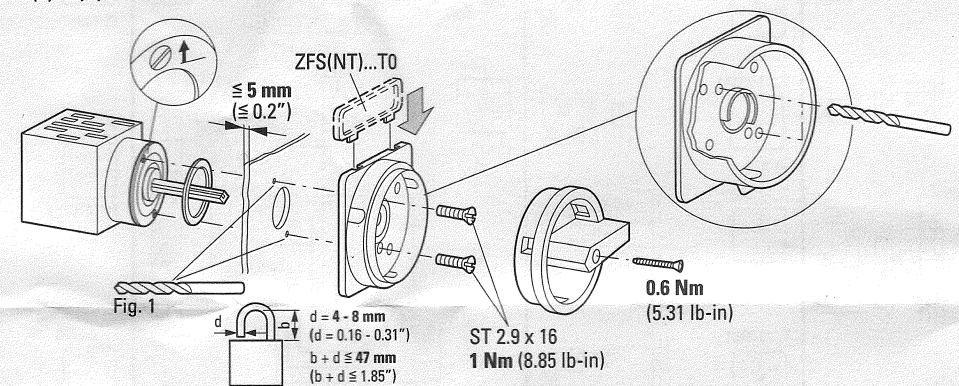

Fig. 2
→ * 1:1



T0(3)-.../E/SVB



T0(3)-.../EA/SVB

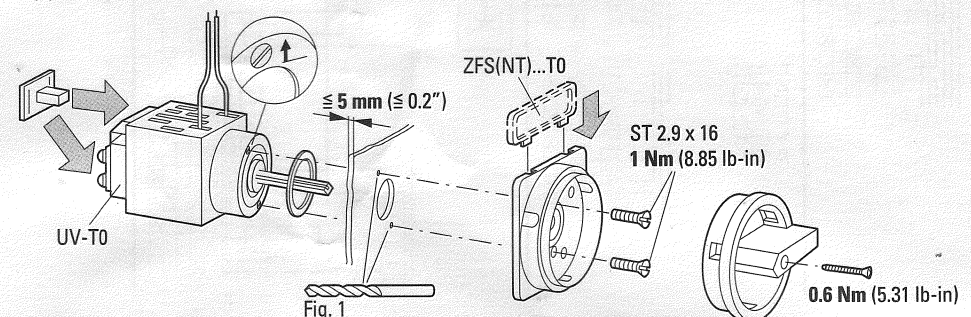

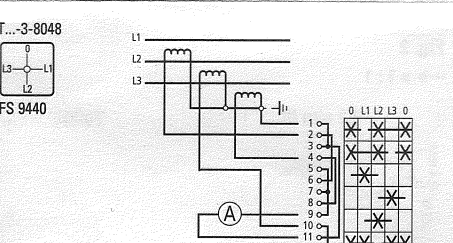
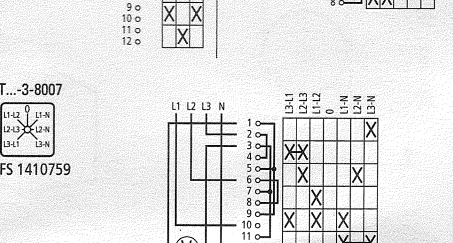
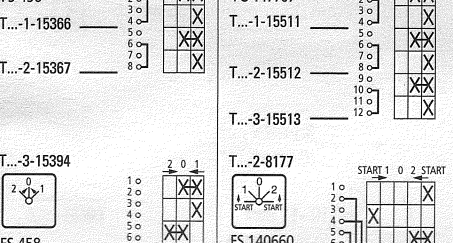
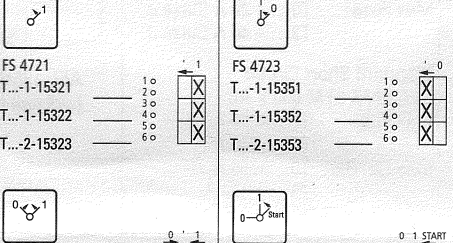
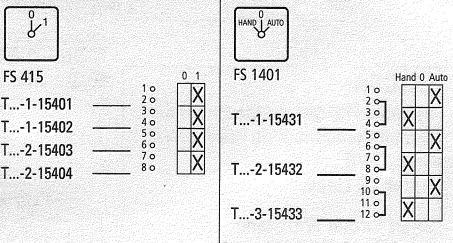
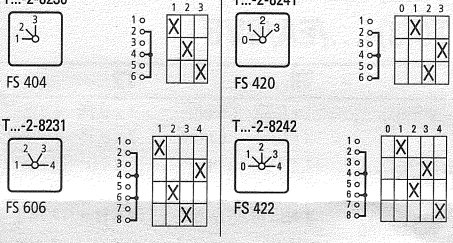
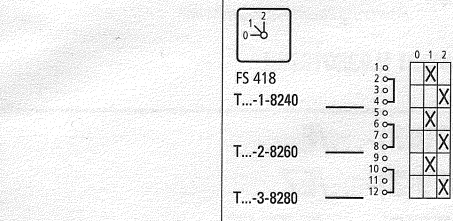
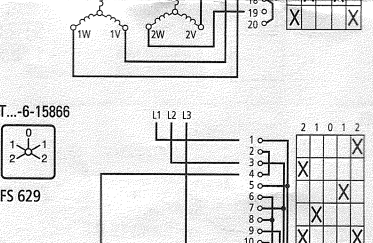
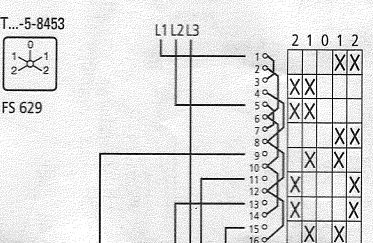
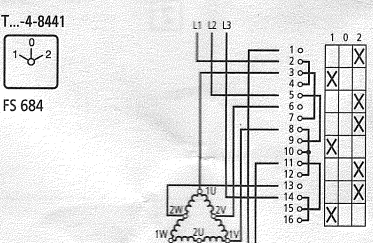
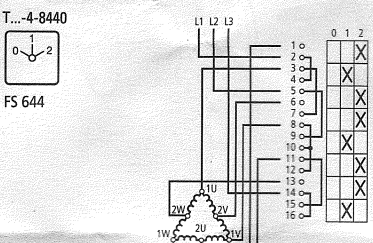
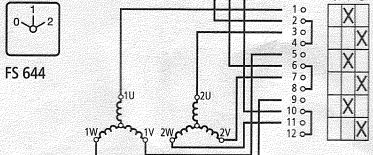
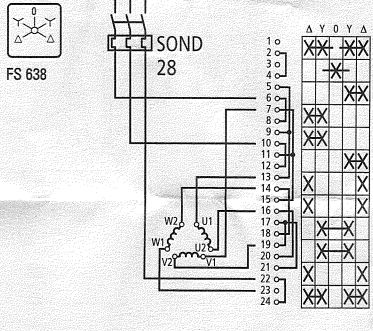
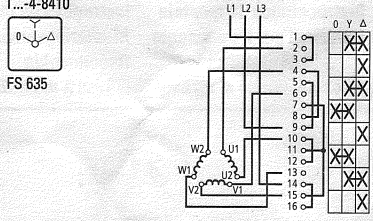
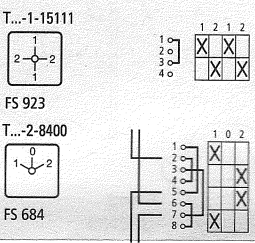
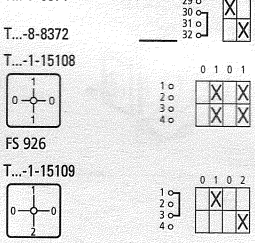
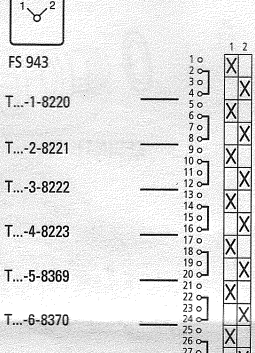
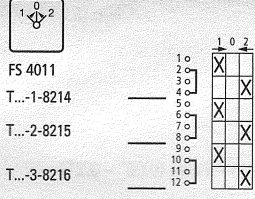
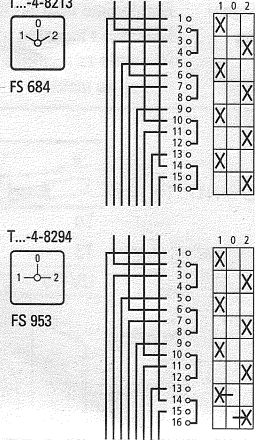
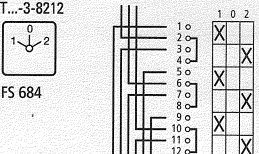
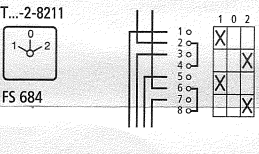
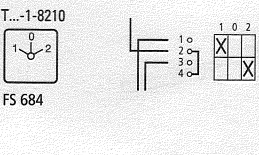
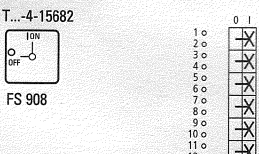
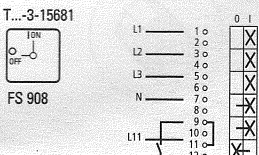
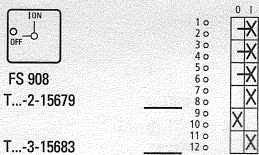
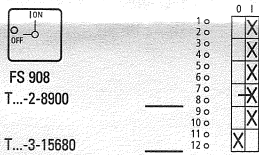
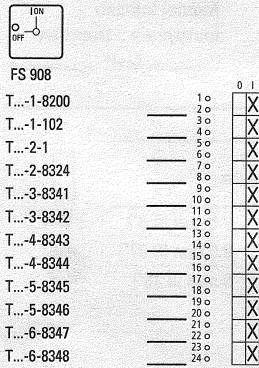

06/21 IL03801020Z