



User Manual



LiFePO4 Battery System

High voltage energy storage Lithium battery pack

Contents

1.INTRODUCTION	1
2.SYMBOLS	1
3.SAFETY	2
3.1 Safety rules.....	2
3.2 Safety information.....	2
3.3 Handling.....	2
3.4 Installation.....	3
4.RESPONSE TO EMERGENCY SITUATIONS	3
4.1 Fire Situation.....	3
4.2 Warning Labels.....	3
5.TRANSPORTATION	4
5.1 Regulations for the transport of battery modules.....	4
5.2 Permissible and Impermissible Storage Positions of a Packaged.....	5
6.PRODUCT INFORMATION	5
6.1 Battery Module Specifications.....	5
7.ELECTRICAL CONNECTIONS	7
7.1 Battery System Features.....	7
7.2 Battery system introduction.....	7
7.3 Electrical Interface Description of Control cabinet.....	8
7.4 Battery box introduction.....	8
7.5 Base introduction.....	9
7.6 Switch On / Off.....	9
8.INSTALLATION	9
8.1 Items in the package.....	9
8.2 Product size information.....	11
8.3 Tools.....	12
8.4 Floor installation with base.....	12
8.5 Installation Procedure.....	13
8.6 Install Environment.....	15
8.7 System Wiring Schematic.....	15
8.8 Ground connection.....	16
8.9 Power line connection.....	17
8.10 Terminal Connection.....	17
8.11 Description for Communication port.....	17
8.12 Install protective cover.....	18
9.LCD DISPLAY ICONS	19
9.1 Main interface.....	19
9.2 Fault Code Table.....	21
10.WARRANTY	22
11.TROUBLESHOOTING AND MAINTENANCE	22
11.1 Maintenance.....	22
11.2 Troubleshooting.....	22







1. INTRODUCTION

The document describes the installation, commissioning, maintenance and troubleshooting of the following high voltage battery listed below.

The battery chemistry of these products is Lithium Iron Phosphate. This manual is designed for qualified personnel only. The tasks described in this document should be performed by authorized and qualified technicians only.

After Installation the Installer must explain the user manual to the end user.

2. SYMBOLS

	Caution, risk of electric shock.
	Do not place nor install near flammable or explosive materials.
	Install the product out of reach of children.
	Read the instruction manual before starting installation and operation.
	Do not dispose of the product with household wastes.
	Recyclable.
	Disconnect the equipment before carrying out maintenance or repair.
	Observe precautions for handling electrostatic discharge sensitive devices.
	Protective Class 1.
	Caution, risk of electric shock, energy storage timed discharge.

SPECIFICATIONS FOR LUX-X-96050HMG01

The battery system is mainly used insolar power system for family houseelt also has a switch to coontrol the battery easilyand timely protect our Household application

3. Safety

3.1 Safety rules

To avoid property damage and personal injury, the following rules shall be flowled when working on the hazardous live parts of the battery energy storage system:

- It is available for use.
- Ensure that it will not restart.
- Make sure there is no voltage.
- Grounding protection and short circuit protection.
- Cover or shield adjacent live parts.

3.2 Safety information

Part damage or short circuit may cause electric shock and death. A short circuit can be caused by connecting battery terminals, resulting in current flow, This type of short circuit shall be avoided under any circumstances, For this reason, follow these instructions:

- Use insulated tools and gloves.
- Do not place any tools or metal parts on the battery module or high-voltage control box.
- When operating the battery, be sure to remove watches, rings, and other metal objects.
- Do not install or operate this system in explosive or high-humidity areas.
- When working on the energy storage system, first turn off the charging controller, then the battery, and ensure that they are not turned on again.

Improper use of the battery energy storage system can lead to death. The use of the battery energy storage system beyond its intended use is not allowed, because it may cause great danger.

Improper handling of the battery energy storage system can cause life-threatening risks, serious injury or even death.

 **Warning!** improper use can cause damage to the battery cell.

- Do not expose the battery module to rain or soak it in liquid.
- Do not expose the battery module to a corrosive environment (such as ammonia and salt).

3.3 Handling

- Do not expose battery to open flame.
- Do not place the product under direct sunlight.
- Do not place the product near flammable materials.
- Store the product on a flat surface.
- Store the product out of reach of children and animals.
- Do not damage the unit by dropping, deforming, impacting, cutting or penetrating with a sharp object.
- Do not touch any liquid spilled from the product.
- Always handle the battery wearing the insulated gloves.
- Do not step on the product or place any objects on it.
- Do not charge or discharge damaged battery.

3.4 Installation

- After unpacking, please check the product for damages and missing parts.
- Make sure that the inverter and battery is completely turned off before commencing installation.
- Do not interchange the positive and negative terminals of the battery.
- Ensure that there is no short circuit of the terminals or with any external device.
- Do not exceed the battery voltage rating of the inverter.
- Do not connect the battery to any incompatible inverter.
- Do not connect different battery types together.
- Please ensure that all the batteries are grounded properly.
- Do not open the battery to repair or disassemble.
- In case of fire, use only dry powder fire extinguisher.
- Install the battery away from children or pets.
- Do not use battery in high static environment where the protection device might be damaged.
- Do not install with other batteries or cells.

4. RESPONSE TO EMERGENCY SITUATIONS

The batteries comprise of multiple batteries connected in series. It is designed to prevent hazards or failures. However, FelicityESS cannot guarantee their absolute safety. Under exposure to the internal materials of the battery the following recommendations should be carried out by the user.





- If there has been inhalation, please leave the contaminated area immediately and seek medical attention.
- If there has been contact with eyes, rinse the eyes with running water for 15 minutes and seek medical attention immediately.
- If there has been contact with the skin, wash the contacted area with soap thoroughly and seek medical attention immediately.
- If there has been ingestion, induce vomiting and seek medical attention.

4.1 Fire Situation

Use a FM-200 or Carbon Dioxide (CO2) fire extinguishers to extinguish the fire if there is a fire in the area where the battery pack is installed. Wear a gas mask and avoid inhaling toxic gases and harmful substances produced by the fire.

4.2 Warning Labels











Warning labels and other relevant labels are attached on the battery pack.





 	
High Voltage Battery Cluster Controller	
Model	LUX-X-96050HCG01
Nominal Voltage	80-720V
Nominal Charge/Discharge Current	50A
Communication	RS485 / CAN
Cycle Life	≥6,000@25°C, 80% DOD
IP Rating of Enclosure	IP65
Working Temperature Range	Charge: 0°C-55°C
	Discharge: -20°C-55°C
  	













WARNING





- Do not disassemble or alter the Pack to avoid heating up, explosion or fire.
- Do not use the Pack beyond specified conditions. Or it may cause heating up, damage or degrading its performance.
- Do not throw, drop, hit, drive in nail or stamp on the Pack. Or it may cause heating up, explosion or fire.
- Do not put the Pack into fire. Do not use or leave it at the places near fire, heater or high temperature sources. Or it may cause over temperature, explosion or fire.
- Do not put the Pack into the water or wet it. Or it may cause heating up, explosion or fire.
- Do not connect the Pack's positive(+) and negative(-) terminal reversely. Or it will cause short circuit, explosion or fire.
- Do not connect the Pack's positive(+) and negative(-) terminal together or to any other metals. Or it will cause short circuit, explosion or fire.
- Take care! This Pack is heavy enough to cause serious injury.
- In case of electrolyte leakage, keep leaked electrolyte away from eyes or skin. If it has touched your eyes, please wash it with plenty of water and go to the hospital immediately.
- Keep out of the reach of children and animals.





















 	
LiFePO4 Battery	
Model	LUX-X-96050HGM01
Nominal Voltage	102.4V
Nominal Capacity	50Ah
Nominal Energy	5.12kWh
Enclosure Protection Rating	IP65
Charging Temperature Range	0-55°C
Discharging Temperature Range	-20-55°C
  	

 	
Lithium Iron Phosphate Battery	
Model	LUX-X-96050HG01M2
Nominal Energy	10.24kWh
Nominal Voltage	204.8V
Nominal Capacity	50Ah
Nominal Charge/Discharge Current	50A
Communication	RS485 / CAN
Cycle Life	≥6,000@25°C, 80% DOD
IP Rating of Enclosure	IP65
Working Temperature Range	Charge: 0°C-55°C
	Discharge: -20°C-55°C
IFpP/41/150/102[(1P32S)2S]M-10+50/90	
  	

 	
Lithium Iron Phosphate Battery	
Model	LUX-X-96050HG01M3
Nominal Energy	15.36kWh
Nominal Voltage	307.2V
Nominal Capacity	50Ah
Nominal Charge/Discharge Current	50A
Communication	RS485 / CAN
Cycle Life	≥6,000@25°C, 80% DOD
IP Rating of Enclosure	IP65
Working Temperature Range	Charge: 0°C-55°C
	Discharge: -20°C-55°C
IFpP/41/150/102[(1P32S)3S]M-10+50/90	
  	

 	
Lithium Iron Phosphate Battery	
Model	LUX-X-96050HG01M4
Nominal Energy	20.48kWh
Nominal Voltage	409.6V
Nominal Capacity	50Ah
Nominal Charge/Discharge Current	50A
Communication	RS485 / CAN
Cycle Life	≥6,000@25°C, 80% DOD
IP Rating of Enclosure	IP65
Working Temperature Range	Charge: 0°C-55°C
	Discharge: -20°C-55°C
IFpP/41/150/102[(1P32S)4S]M-10+50/90	
  	

 	
Lithium Iron Phosphate Battery	
Model	LUX-X-96050HG01M5
Nominal Energy	25.6kWh
Nominal Voltage	512V
Nominal Capacity	50Ah
Nominal Charge/Discharge Current	50A
Communication	RS485 / CAN
Cycle Life	≥6,000@25°C, 80% DOD
IP Rating of Enclosure	IP65
Working Temperature Range	Charge: 0°C-55°C
	Discharge: -20°C-55°C
IFpP/41/150/102[(1P32S)5S]M-10+50/90	
  	

 	
Lithium Iron Phosphate Battery	
Model	LUX-X-96050HG01M6
Nominal Energy	30.72kWh
Nominal Voltage	614.4V
Nominal Capacity	50Ah
Nominal Charge/Discharge Current	50A
Communication	RS485 / CAN
Cycle Life	≥6,000@25°C, 80% DOD
IP Rating of Enclosure	IP65
Working Temperature Range	Charge: 0°C-55°C
	Discharge: -20°C-55°C
IFpP/41/150/102[(1P32S)6S]M-10+50/90	
  	

5. TRANSPORTATION

5.1 Regulations for the transport of battery modules

It is necessary to comply with the relevant regulations and provisions on roads for shipping lithium-ion products in the corresponding countries.



- Smoking is prohibited in the vehicle during transportation or in the vicinity during loading and unloading



- The dangerous goods transport vehicles shall meet relevant regulations concerning road transportation and shall be equipped with two tested CO2 fire extinguishers.



- The battery energy storage system can be damaged, if not properly transported. The battery module can only be transported vertically. Note that these parts may be top-heavy. Failure to follow this instruction may result in damage to the part.



- If possible, do not remove the transport packaging before arrival at the installation site. Before removing the transport protector, check if the transport packaging is damaged.



- Improper transport of battery modules may cause injury. The single battery module weighs 57.5kg. It could cause injury if it falls or slips. Use only suitable transport and lifting equipment to ensure safe transport.



• Wear safety shoes to avoid the danger of injury. When transporting the battery module, their parts may be crushed due to their heavy weight. Therefore, all persons involved in transportation must wear safety shoes with toe caps. Please observe the safety regulations for transportation at the end customer's site, especially during loading and unloading.



• During transportation and installation of unpacked battery storage cabinets, the risk of injury increases, especially on sharp metal panels. Therefore, all personnel involved in transportation and installation must wear protective gloves.



• Improper vehicle transportation can cause injury. Improper transportation or improper transportation locks may cause the load to slip or overturn, resulting in injury.

5.2 Permissible and Impermissible Storage Positions of a Packaged

The battery module can only be transported in an upright position.

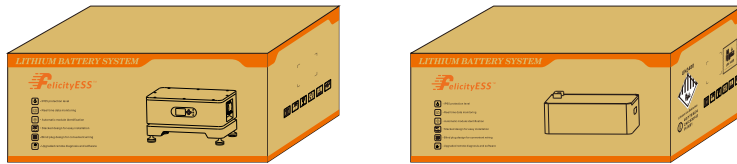

6.PRODUCT INFORMATION

- LUX-X-96050HCG01 is a battery module, it needs to be used with LUX-X-96050HCG01 controller;
- LUX-X-96050HMG01 is the controller of the whole system, so each system must have one LUX-X-96050HCG01;
- Our system consists of at least 1 LUX-X-96050HCG01 + 1 LUX-X-96050HCG01 and up to 6 LUX-X-96050HMG01 + 1 LUX-X-96050HCG01.

6.1 Battery Module Specifications

Model	LUX-X-96050HG01					
Battery Type	LiFePO4					
Module Energy	5.12kWh					
Module Nominal Voltage	102.4V					
Module Capacity	50Ah					
Number of Battery Modules	1	2	3	4	5	6
System Energy	5.12kWh	10.24kWh	15.36kWh	20.48kWh	25.6kWh	30.72kWh
System Nominal Voltage	102.4V	204.8V	307.2V	409.6V	512V	614.4V
System Operating Voltage	96-115.2V	192-230.4V	288-345.6V	384-460.8V	480-576V	576-691.2V
Recommend Charge/Discharge current	25A	25A	25A	25A	25A	25A
Max. continuous charge/discharge current[1]	50A	50A	50A	50A	50A	50A
Peak Charge/Discharge current(15S)	60A	60A	60A	60A	60A	60A

Depth of discharge(DOD)	≥ 95%	
Display type	LED+LCD(Touch)	
IP Rating of Enclosure	IP65	
Operating Temperature Range	Charge:0~+55°C/Discharge:-20C~+55°C	
Storage Temperature Range	0°C~+35°C	
Humidity	5%~95%	
Altitude	≤2000m	
Cycle Life[2]	≥ 6000 Cycles	
Installation	Stacking-Mounting / Floor-Mounting	
Protection	Built-in smart BMS, Breaker	
Communication Port	RS485 / CAN	
Warranty Period[3]	10 Year	
Control Module LUX-X-96050HCG01	Net Weight	12.5 kg
	Gross Weight(with base)	24.5 kg
	Product Dimension	600x385x200 mm
	Package Dimension (with base)	712x497x352 mm
Battery Module LUX-X-96050HMG01	Battery Designation[4]	IFpP/41/150/102/[(1P32S)NS]M/-10+50/90
	Net Weight	57.5kg
	Gross Weight	62kg
	Product Dimension	600x385x260 mm
Package Dimension	712x497x378 mm	
[1] Max. continuous charge/discharge current is affected by temperature and SOC.		
[2] Test conditions: 0.2C Charging/Discharging @25°C, 80% DOD.		
[3] Conditions apply, refer to FelicityESS Warranty policy.		
[4] "N" means the number of battery packs connected parallel and should not exceed 6. (N≤6)		

Charging method:

When the battery and inverter establish communication, the constant current of 50A is charged until the battery voltage reaches 108.8V * N, and then the current decreases linearly until the voltage reaches 113.6V * N and the current drops to 0A (N is the number of battery packs in series)

7.ELECTRICAL CONNECTIONS

7.1 Battery System Features

The batteries have been fitted with multiple protection systems to ensure the safe operation of the system. Some of the protection system includes:

- Inverter interface protection: Over voltage, Over current, External Short Circuit, Reverse Polarity Ground Fault, Over Temp, In rush current.
- Battery Protection: Internal Short Circuit, Over voltage, over current, over temp, Under voltage The battery system contains the following Interface to allow it to connect and operate efficiently.
- LiFePO4: Higher safe performance and longer cycle life.
- Flexible Installation: Stack-Mounted.
- Wide Compatibility: Compatible with leading inverter brands.

7.2 Battery system introduction

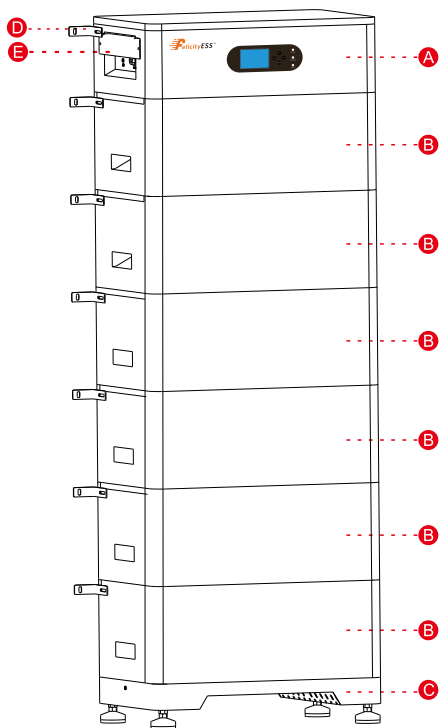

Code	Name
A	Control cabinet
B	Battery box
C	Pedestal
D	Fixed trestle
E	Safety shield

7.3 Electrical Interface Description of Control cabinet

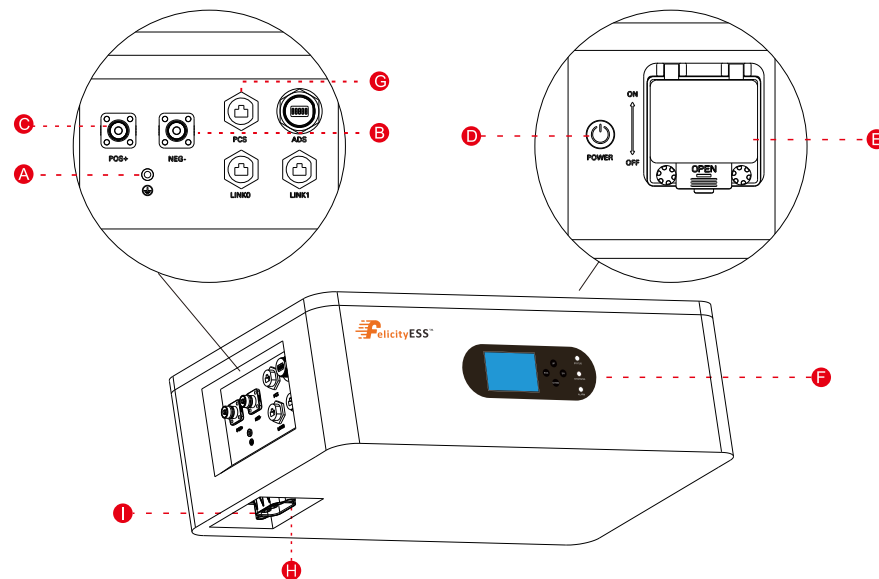

Code	Name
A	Earth Terminal
B	NEG -
C	POS +
D	Power Switch
E	Breaker
F	LCD display
G	PCS Communication
H	Blind plug terminal
I	Bleed valve

7.4 Battery box introduction

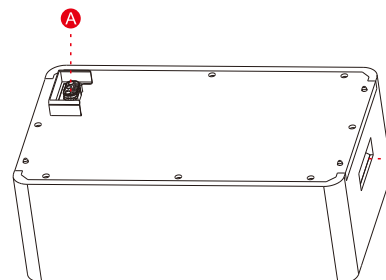

Code	Name
A	Blind plug terminal
B	Handle

7.5 Base introduction

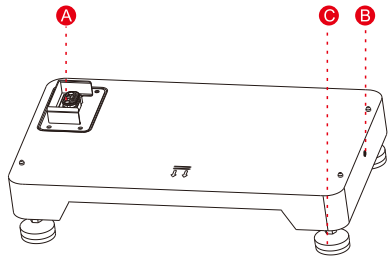

Code	Name
A	Blind plug terminal
B	Earth terminal
C	Foot cup

7.6 Switch On/Off

Switch on: close the breaker to the ON block, press and hold Power switch for 2-3 seconds, the battery will perform self-test before output. The LCD will show SOC.
 Switch off: close the breaker to the OFF block, the battery will shut down directly.

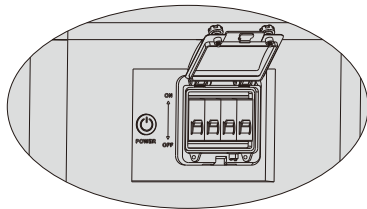

Power ON battery system

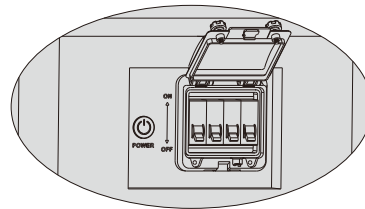

Power OFF battery system







8.INSTALLATION

8.1 Items in the package

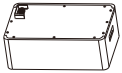
Packaging information

- The battery system consists of a battery, a control box, and a base.
- Before unpacking the battery system, check whether the packaging is damaged and check the battery system model. If anything goes wrong, Do not open the packing case, and contact the after-sales service center as soon as possible.
- After unpacking the battery system, check the completeness of the product delivery against the packaging information. If there is any anomaly, please contact the after-sales service center as soon as possible.

LUX-X-96050HCG01			
NO.	DESCRIPTION	QUANTITY	PICTURE
1	Control cabinet	1	
2	Pedestal	1	
3	User manual	1	
4	Warranty card	1	
5	Power Cable 1: 2 meters, 6mm ² , allows for charging and discharging up to 30A, used to connect to external PCS- (black).	1	
6	Power Cable 2: 2 meters, 6mm ² , allows for charging and discharging up to 30A, used to connect to external PCS+ (red).	1	
7	Communication line 1: The communication between the battery pack and the PC	1	
8	Communication Line 2: Communication between the battery pack and the Felicity inverter	1	
9	Communication cable 3: The battery pack communicates with the battery pack in parallel	1	
10	Expansion Plastic Screw: used together for product fixation.	2	
11	BOT Foot Cup: used for supporting the product.	4	
12	Signal Terminal: used for creating custom communication cables.	2	
13	Fixed trestle: Used for fixing products	2	

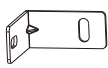
LUX-X-96050HMG01			
NO.	DESCRIPTION	QUANTITY	PICTURE
1	5.12kWh Battery box	1	
2	User manual	1	
3	Warranty card	1	
4	Expansion Plastic Screw: used together for product fixation.	2	
5	Screw: used for installing battery pack modules.	3	
6	Fix the bracket	1	
7	Fixed trestle: Used for fixing products	2	

8.2 Product size information

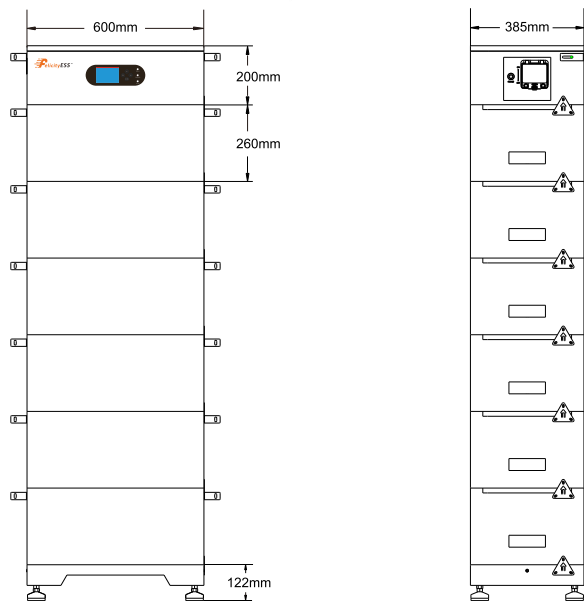

8.3 Tools



8.4 Floor installation with base

Installation Location Requirements

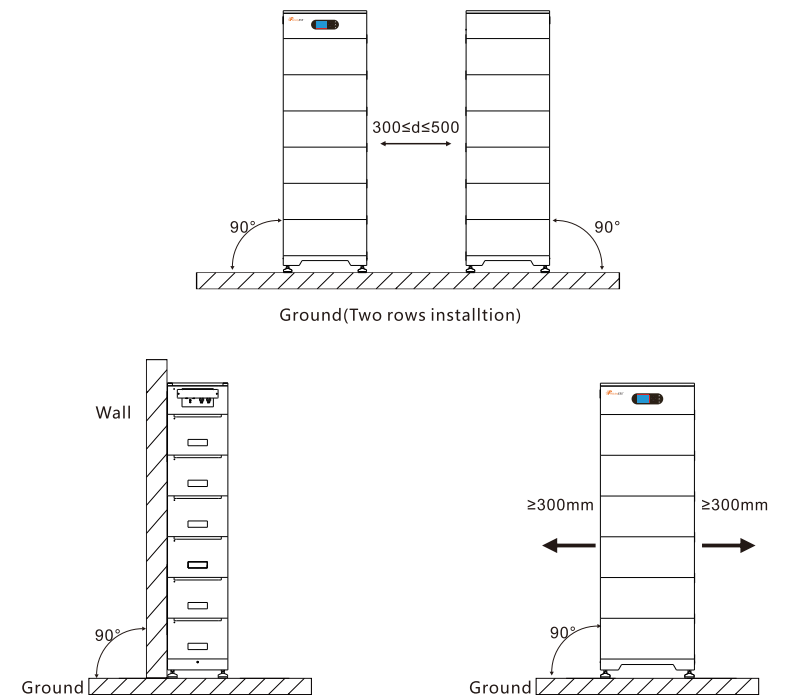

8.5 Installation Procedure

- Step 1: Remove the battery, base and control box from the carton.
- Step 2: Place the base against the wall.
- Step 3: Install 1~6 battery boxes on the base, and then place the control box above the installed battery to ensure it is firmly placed.
- Step 4: Install the anti-tipping bracket of the control box, mark the punching position with a marker, and remove the anti-tipping bracket and the control box.
- Step 5: Use the impact drill to drill holes. (Aperture: 10mm, depth: 60mm).
- Step 6: Use a hammer to knock the plastic plug into the hole, fit it to the wall, then reinstall the control box and the anti-tipping bracket, and tighten the screws on the anti-tipping bracket. The torque requirement is 10N · m to ensure that the control box is firmly installed.

Step 1:

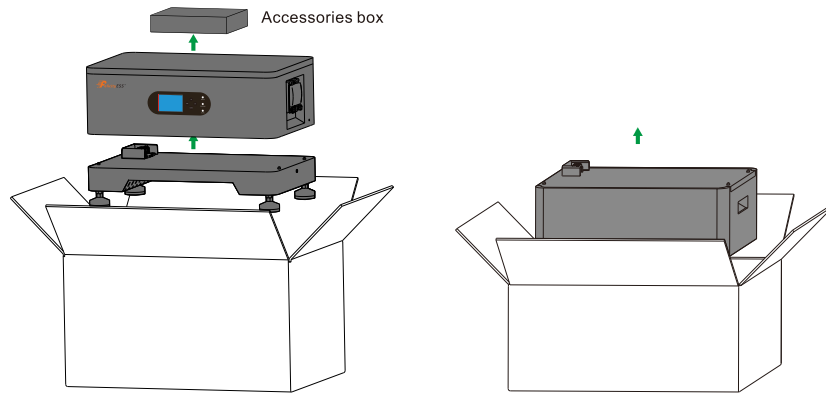

Step 2:

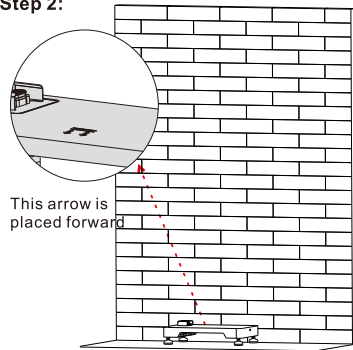

Step 3:

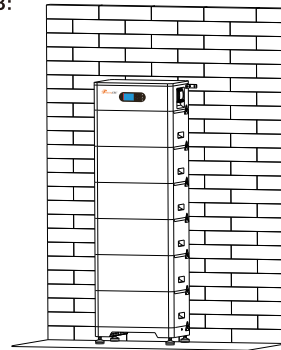

Step 4:

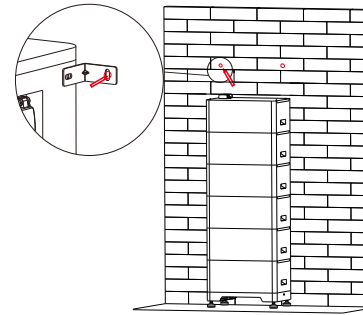

Step 5:

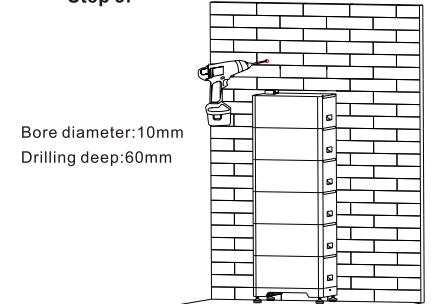

Step 6:

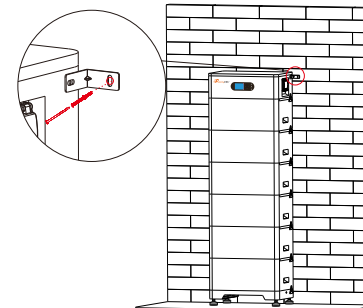

Step 7:

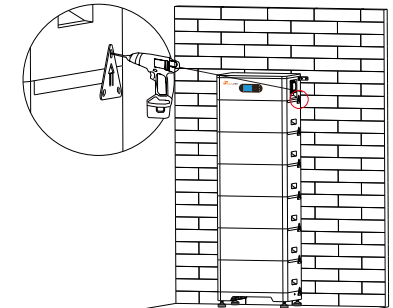

Note:

1. Check that the ground is flat and free of tilt before installation.
2. Make sure that the base is vertical and close to the ground.
3. Make sure that the base is against the wall and the arrow direction on the base faces outward when placing.
4. When placing the upper battery, make sure that the upper and lower hole positions are aligned.
5. Be careful of the battery falling.
6. Avoid installing the anti-tipping bracket on the same side
7. There is no gap between battery packs and battery packs during stack installation. If there is a gap, place the battery pack with the gap on the lower layer.

8.6 Install Environment

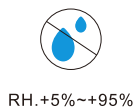
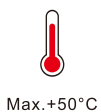
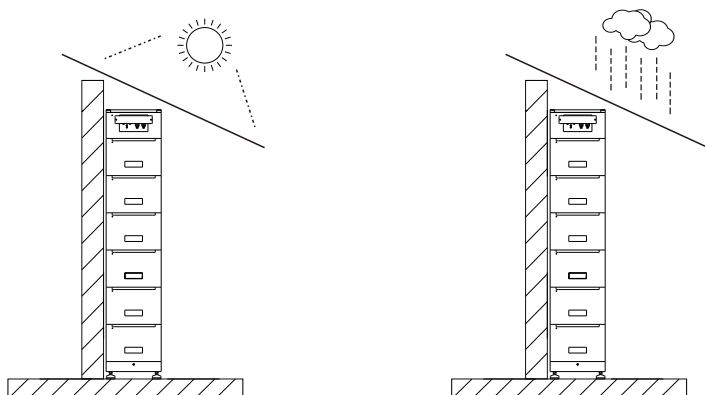

8.7 System Wiring Schematic

Matching side inverter T-REX-10KHP3G01

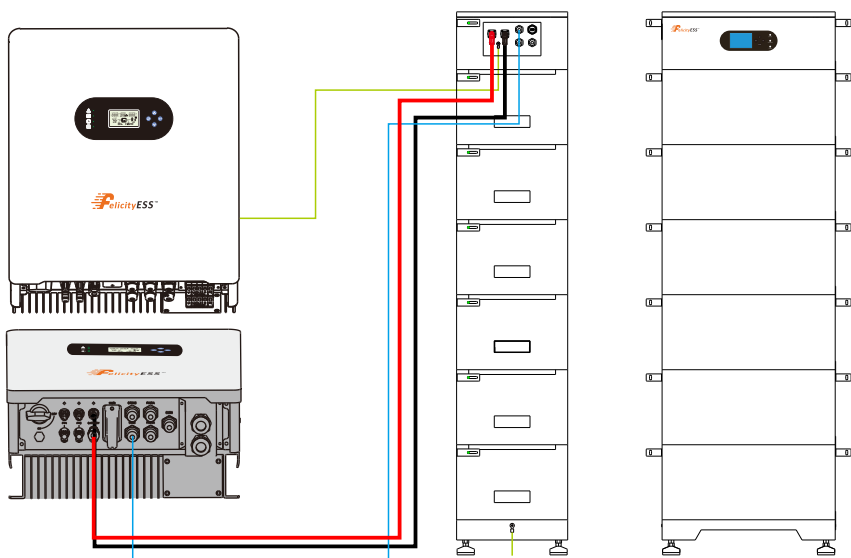

8.8 Ground connection

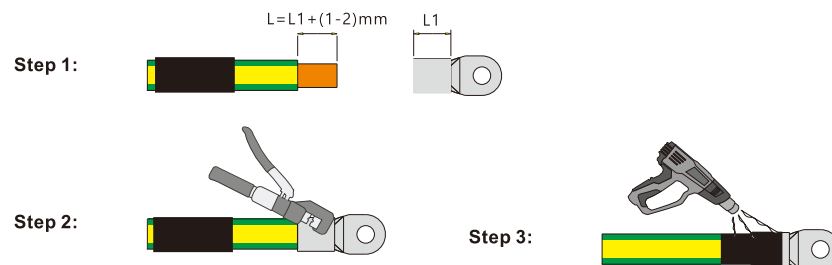

Note:

- When installing equipment, the protective ground wire must be installed first;
- When removing the equipment, the protective ground wire must be removed finally.
- The drawing force after crimping shall be greater than 400N.
- The control box is connected to the ground wire of the b

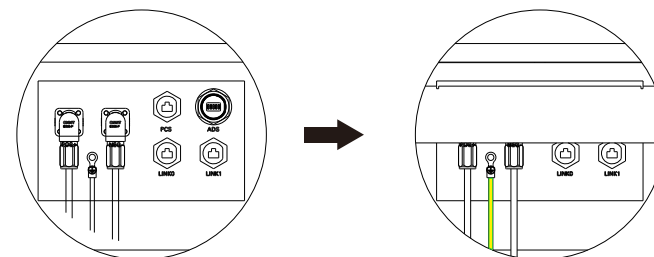

Note: Press the position indicated in the figure above before disconnecting the power terminal.

8.9 Powerline connection

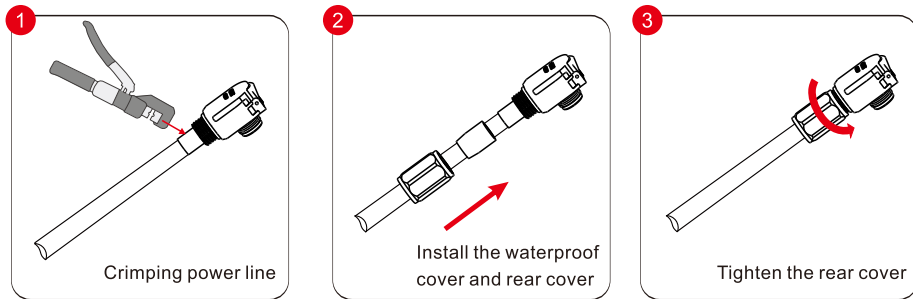

8.10 Terminal Connection

Power terminal

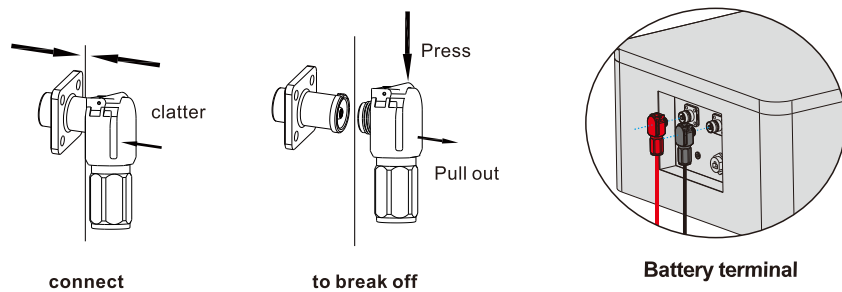

Note: Press the position indicated in the figure above before disconnecting the power terminal.

8.11 Description for Communication port

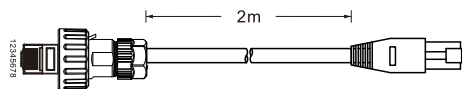

PCS Port Pin Definition

Pin	Function Definitions	Function Declaration
1	NC	NC
2	NC	NC
3	NC	NC
4	CAN-H	Communication between the battery pack and the inverter through the CAN port
5	CAN-L	
6	CAN-GND	CAN-GND
7	RS485-A	Communication between the battery pack and the inverter through the RS485 port
8	RS485-B	

8.12 Install protective cover

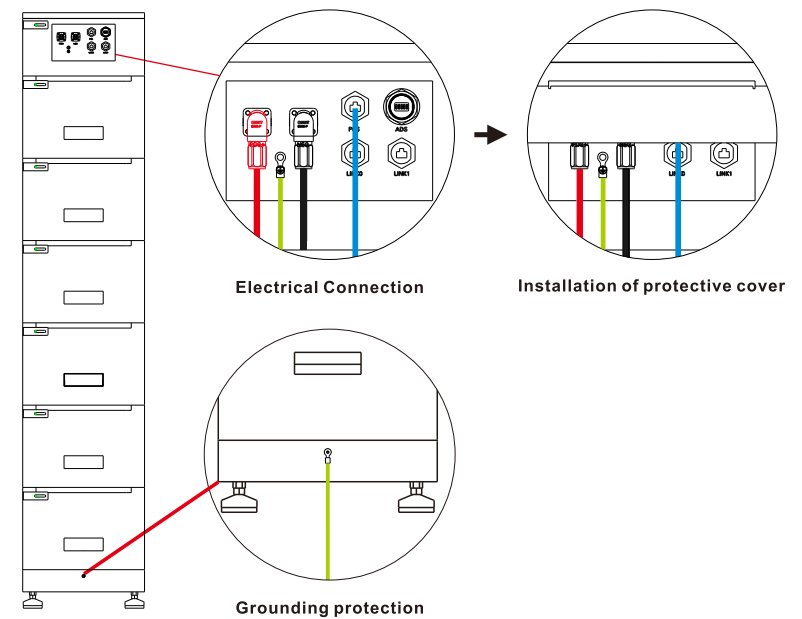

9.LCD Displayicons

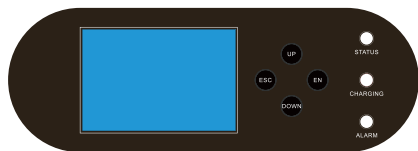

OBJECT	NAME	DESCRIPTION
A	LCD touch screen	Display the information of the battery.
B	Status LED	Indicates the operating status of the battery, which is always on when running normally.
C	Charging LED	Indicates the charging status of the battery, flashing indicates charging.
D	Alarm LED	Indicates the fault status of the battery, which lights up when the fault occurs.
ESC	Function Button	Esc: Return from current interface or function.
UP		Up: Move cursor to upside or increase value.
DOWN		Down: Move cursor to downside or decrease value.
EN		Enter: Confirm the selection.

9.1 Main interface

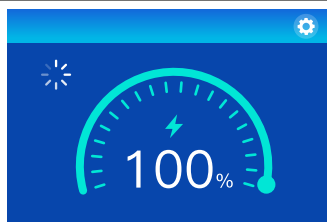

Battery Information

	Indicate SOC.
	I Indicates the battery level, with each grid representing 5%.

	When charging, this icon lights up
	This icon lights up to indicate that the battery is waiting to be connected, and there is no output at this time. After entering normal working mode, this icon disappears.

Sum data interface:

This interface displays a summary of battery parallel connection information, including average battery voltage, total battery current, average BMS temperature, number of parallel connections, charging limit voltage, discharging limit voltage, charging limit current, discharging limit current, and fault information. Click "Sum Data" and "Details Data" to switch between summary data or detailed data of parallel batteries

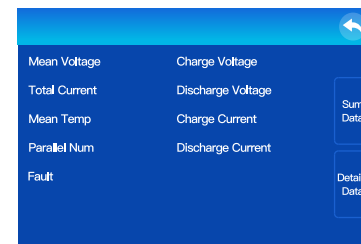

Details data interface:

This interface displays a summary of battery parallel connection information, including average battery voltage, total battery current, average BMS temperature, number of parallel connections, charging limit voltage, discharging limit voltage, charging limit current, discharging limit current, and fault information. Click "Sum Data" and "Details Data" to switch between summary data or detailed data of parallel batteries

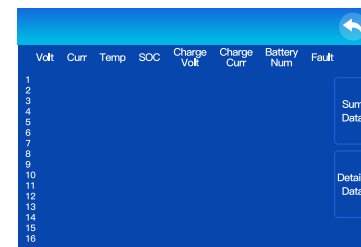

Details data interface:

This interface displays detailed information about parallel batteries, including minimum cell voltage, minimum cell voltage number, maximum cell voltage, maximum cell voltage number, minimum cell temperature, minimum cell temperature number, maximum cell temperature, and maximum cell temperature number

1 to 16 represent the addresses of parallel batteries.

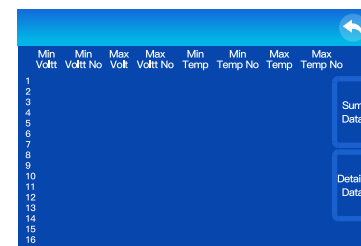

9.2 Fault Code Table

FAULT CODE	EXPLAIN	TREATMENT MEASURE
01	High Battery Voltage	Stop charging
02	Low Battery Voltage	Stop discharging
03	High Cell Voltage	Stop charging
04	Low Cell Voltage	Stop discharging
05	High Charging Current	Reduce charging current
06	High Discharging Current	Reduce discharging current
07	High Bms Temperature	Stop charging and discharging ,wait for the temperature to drop
08	Low Bms Temperature	Wait for temperature rise
09	High Cell Temperature	Stop charging and discharging , wait for the temperature to drop
10	Low Cell Temperature	Wait for temperature rise
11	Afe fault	Restart, if the fault still exists, contact our engineer
12	Soft Start Failed	Restart, if the fault still exists, contact our engineer
13	Slave Communication Failure	Check for poor contact of the communication line
14	Low Output Impedance	Restart, if the fault still exists, contact our engineer
15	Slave Version Fault	Contact our engineer to upgrade the progra

10. WARRANTY

The warranty shall not cover the defects caused by normal wear and tear, inadequate maintenance, handling, storage faulty repair, modifications to the battery or pack by a third party other than FelicityESS, failure to observe the product specification provided herein or improper use or installation, including but not limited to the following.

Damage during transport or storage.

- Incorrect Installation of battery into pack or maintenance.
- Use of battery pack in appropriate environment.
- Improper, inadequate, or incorrect charge, discharge or production circuit other than stipulated herein.
- Incorrect use or inappropriate use.
- Insufficient ventilation.
- Ignoring applicable safety warnings and instructions.
- Altering or attempted repairs unauthorized personnel.
- In case of force majeure (ex: lightning, storm, flood, fire, earthquake, etc.).
- There are no warranties-implicit or express-other than those stipulated herein. FelicityESS shall not be liable for any consequential or indirect damages arising or in connection with the product specification, battery or pack.

11. TROUBLESHOOTING AND MAINTENANCE

11.1 Maintenance

- 1.Regularly check whether the service environment of the battery meets the requirements, and the installation position should be far away from the heat source.
- 2.In case of one of the following situations, it needs to be charged in time:
 - The battery is often under charged;
 - The battery has been out of use or stored for more than 3 months.
- 3.Regularly check whether the battery and its supporting terminals, connecting cables and indicator lights are normal.

11.2 Troubleshooting

When the red / white LCD on the panel is flashing or normally on, it does not mean that the Battery system is abnormal, it may be just an alarm or protection. Please check the 'LCD fault message' in chapter 7 for the detailed faulty definition before any trouble-shooting steps. In general, the alarm indication is normal without manual intervention. When the alarm triggering state is removed, Battery system will automatically return to normal use.

- Problem determination based on the following points

- Whether the red light on the LUX-X-96050HCG01 is on;
- Whether the battery can be output voltage or not.
- Whether the battery system can be communicated with inverter;

- Preliminary determination steps

LiFePO4 Battery System for HouseholdsBattery system cannot work, when DC switch on and POWER on, the LCD doesn't light up or flash, please consider contact the local distributor.

- The LCD display of LUX-X-96050HCG01 is normal, but it cannot charge and discharge. Observe the display screen of inverter and there is no SOC. Please check whether the CAN communication between LUX-X-96050HCG01 to inverter is well connected. If the connection is good, please replace a CAN communication cable. If the SOC is still not visible on the inverter display screen, please contact the local distributor.
- After the battery system is powered on, if you can see the alarm information on the LCD and inverter display screen at the same time, please contact the local distributor.