

*Solar inverter*

# USER GUIDE

## Solar Inverter

IVEM Series(8KVA)

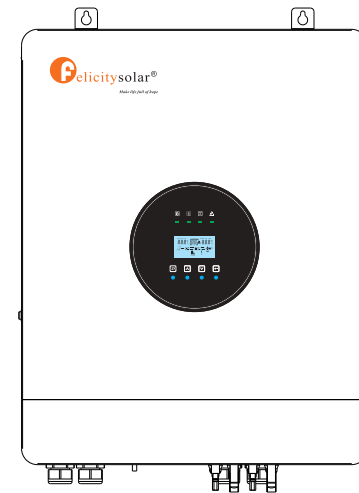

# Contents

<b>ABOUT THIS MANUAL.....</b>	<b>01</b>
Purpose .....	01
Scope .....	01
Safety instructions.....	01
<b>WARNING MARKS.....</b>	<b>02</b>
<b>INTRODUCTION.....</b>	<b>03</b>
Features .....	03
Basic system architecture .....	03
<b>PRODUCT OVERVIEW .....</b>	<b>04</b>
<b>SPECIFICATIONS.....</b>	<b>05</b>
<b>INSTALLATION.....</b>	<b>08</b>
Safety guidance.....	08
Unpacking and inspection .....	08
Preparation .....	09
Mounting the unit .....	09
Battery connection .....	10
AC input /output connection .....	11
PV connection .....	13
Components for PV connectors and Tools.....	14
Final assembly.....	15
Dry contact signal.....	15
Wiring System for Inverter .....	16
<b>OPERATION .....</b>	<b>17</b>
Power ON/OFF .....	17
Operation and display panel.....	17
LCD display icons.....	18
LCD operation flow chart .....	20
Base information Page .....	20
Setting Page .....	22
Energy stored data Page.....	28
BMS information Page .....	29
Rated information Page .....	29
Lithium Battery Communication.....	31
<b>PARALLEL INSTALLATION GUIDE .....</b>	<b>32</b>
1.Introduction.....	32
2. Mounting the Unit .....	32
3. LCD Setting and Display .....	35
4.Commissioning .....	35
<b>WARNING CODE TABLE .....</b>	<b>37</b>
<b>FAULT CODE TABLE .....</b>	<b>37</b>

## ABOUT THIS MANUAL

### Purpose

This manual describes the assembly, installation, operation, warning code and fault code of this unit. Please read this manual carefully before installations and operations. Keep this manual for future reference.

### Scope

This manual provides safety and installation guidelines as well as information on tools and wiring.

### Safety instructions











**WARNING: This chapter contains important safety and operating instructions. Read and keep this manual for future reference.**

1. Before using the unit, read all instructions and cautionary markings on the unit, the batteries and all appropriate sections of this manual.
2. **CAUTION** --To reduce risk of injury, charge only deep-cycle lead acid type rechargeable batteries. Other types of batteries may burst, causing personal injury and damage.
3. Do not disassemble the unit. Take it to a qualified service center when service or repair is required. Incorrect re-assembly may result in a risk of electric shock or fire.
4. To reduce risk of electric shock, disconnect all wirings before attempting any maintenance or cleaning. Turning off the unit will not reduce this risk.
5. **CAUTION** – Only qualified personnel can install this device with battery.
6. **NEVER** charge a frozen battery.
7. For optimum operation of this inverter/charger, please follow required spec to select appropriate cable size. It's very important to correctly operate this inverter/charger.
8. Be very cautious when working with metal tools on or around batteries. A potential risk exists to drop a tool to spark or short circuit batteries or other electrical parts and could cause an explosion.
9. Please strictly follow installation procedure when you want to disconnect AC or DC terminals. Please refer to INSTALLATION section of this manual for the details.
10. Fuse is provided as over-current protection for the battery supply.
11. **GROUNDING INSTRUCTIONS** -This inverter/charger should be connected to a permanent grounded wiring system. Be sure to comply with local requirements and regulation to install this inverter.
12. **NEVER** cause AC output and DC input short circuited. Do NOT connect to the mains when DC input short circuits.
13. **Warning!!** Only qualified service persons are able to service this device. If errors still persist after following troubleshooting table, please send this inverter/charger back to local dealer or service center for maintenance.

## WARNING MARKS

Warning marks inform users of conditions which can cause serious physical injury or death, or damage to the device. They also tell users how to prevent the dangers. The warning marks used in this operation manual are shown below:

Mark	Name	Instruction	Abbreviation
 Danger	Danger	Serious physical injury or even death may occur if not follow relevant requirements.	
 Warning	Warning	Physical injury or damage to the device may occur if not follow relevant requirements.	
 Forbid	Electrostatic sensitive	Damage may occur if relevant requirements are not followed.	
 Hot	High temperature	Do not touch the base of the inverter as it will become hot.	
Note	Note	The procedures taken for ensuring proper operation.	Note

## INTRODUCTION

This is a multi-function inverter/charger, combining functions of inverter, MPPT solar charger and battery charger to offer uninterruptible power support with portable size. Its comprehensive LCD display offers user-configurable and easy-accessible button operation such as battery charging current, AC/solar charger priority, and acceptable input voltage based on different applications.

## Features

- Pure sine wave inverter
- Built-in MPPT solar charge controller Supports dual solar input
- Built-in Wi-Fi for mobile monitoring (APP is required)
- Configurable input voltage range for home appliances and personal computers via LCD setting
- Configurable battery charging current based on applications via LCD setting
- Configurable AC/Solar Charger priority via LCD setting
- Compatible to mains voltage or generator power
- Configurable second AC output (Output time customization)
- Auto restart while AC is recovering
- Overload / Over temperature/ short circuit protection
- Inverter running without battery
- Lithium battery activation function.
- Cold start function
- Parallel connection quantity up to 6units (Battery must be connected)

## Basic System Architecture

The following illustration shows basic application for this inverter/charger. It also includes following devices to have a complete running system:

- Generator or Utility.
- PV modules (option)

Consult with your system integrator for other possible system architectures depending on your requirements.

This inverter can power all kinds of appliances in home or office environment, including motor-type appliances such as tube light, fan, refrigerator and air conditioner.

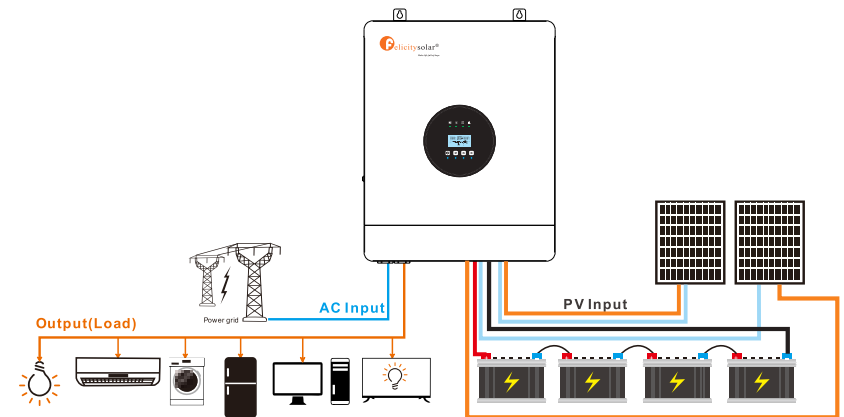

**PRODUCT OVERVIEW**

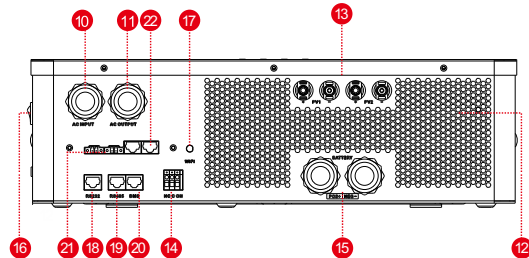
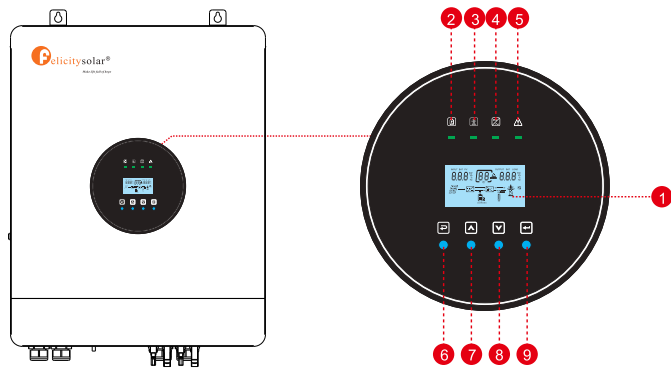

- |                               |                              |                                 |
|-------------------------------|------------------------------|---------------------------------|
| 1. LCD display                | 9. ENTER button              | 16. Switch                      |
| 2. Charging indicator         | 10. AC input port            | 17. Wifi                        |
| 3. Utility bypass indicator   | 11. AC output port           | 18. RS-232 communication port   |
| 4. Inverter indicator         | 12. Fan                      | 19. RS-485 communication port   |
| 5. Fault or warning indicator | 13. PV input connection port | 20. BMS communication port      |
| 6. ESC button                 | 14. Dry contact              | 21. Current sharing port        |
| 7. UP button                  | 15. Battery connection port  | 22. Parallel communication port |
| 8. DOWN button                |                              |                                 |

\* 14 The BMS communication port only supports Felicitysolar batteries

**SPECIFICATIONS**

Line Mode Specifications	
<b>Model</b>	<b>IVEM8048</b>
<b>Rated Output Power</b>	8000VA
	8000W
<b>Nominal DC Input Voltage</b>	48V
<b>Input Voltage Waveform</b>	Sinusoidal (utility or generator)
<b>Nominal Input Voltage</b>	230Vac
<b>Low Line Voltage Disconnect</b>	170Vac±7V (UPS); 90Vac±7V (Appliances)
<b>Low Loss Voltage Re-connect</b>	180Vac±7V (UPS); 100Vac±7V (Appliances)
<b>High Line Voltage Disconnect</b>	280Vac±7V
<b>High Line Voltage Re-connect</b>	270Vac±7V
<b>Max AC Input Voltage</b>	280Vac
<b>Nominal Input Frequency</b>	50Hz / 60Hz (Auto detection)
<b>Low Line Frequency Disconnect</b>	40±1Hz
<b>Low Line Frequency Re-connect</b>	42±1Hz
<b>High Line Frequency Disconnect</b>	65±1Hz
<b>High Line Frequency Re-connect</b>	63±1Hz
<b>Output Voltage Waveform</b>	As same as input waveform
<b>Output Short Circuit Protection</b>	Line mode: Circuit Breaker Battery mode: Electronic Circuits
<b>Efficiency (Line Mode)</b>	>95% (Rated R load, battery full charged)
<b>Transfer Time (Single unit)</b>	10ms typical (UPS); 20ms typical (Appliances)
<b>Transfer Time (Parallel)</b>	50ms typical
<b>Pass Through Without Battery</b>	Yes
<b>Max. Bypass Overload Current</b>	53A
<b>Max. Inverter/Rectifier Current</b>	40A/8000W

Utility Charge Mode Specifications	
Nominal Input Voltage	230Vac
Input Voltage Range	90-280Vac
Nominal Output Voltage	Dependent on battery type
Max. Charge Current	150A
Charge Current Regulation	10-150A (Adjustable unit is 1A)
Over Charge Protection	Yes
Solar Charging & Grid Charging	
Max. PV Open Circuit Voltage	500V
PV Voltage Working Range	90V-450V
Max. Input Power	8000W(5000W for single PV)
Max. Solar Charging Current	150A
Max. Charging Current(PV+Grid)	150A
Max. Input Current	20A×2(MAX 40A)
Min. Startup Voltage	100V









Charge Algorithm			
Algorithm	<b>Three stage:</b> Boost CC (Constant current stage) -> Boost CV (Constant voltage stage) -> Float (Constant voltage stage)		
Charging Curve			
Battery Type Setting	Battery Type	Boost CC/CV	Float
	AGM	56.4V	54V
	Flooded	58.4V	54V
	Self - defined	Adjustable, up to 60V	
	Lithium		

Inverter Mode Specifications	
Model	<b>IVEM8048</b>
Rated Output Power	8000VA
	8000W
Nominal DC Input Voltage	48V
Output Voltage Waveform	Pure sine wave
Nominal Output Voltage	230Vac±5%
Nominal Output Frequency (Hz)	50±0.3Hz/60Hz±0.3Hz (Adjustable)
Parallel capability	Yes, up to 6 units
Peak Efficiency	93%
Over-Load Protection (SMPS load)	5s@ ≥150% load; 10s@105%~150% load
Surge Rating	2* rated power for 5s
Capable of Starting Electric	Yes
Output Short Circuit Protection	Yes
Cold Start Voltage	46V
Low Battery Alarm	45.0V
Load < 50%	44.0V
@Load ≥ 50%	
Low Battery Alarm Recovery	47.0V
Load < 50%	46.0V
@Load ≥ 50%	
Low DC Input Shut-down	43.0V
Load < 50%	42.0V
@Load ≥ 50%	
High DC Input Alarm & Fault	62V±0.4V
High DC Input Recovery	56.4V±0.4V
General Specifications	
Operating Temperature	0C°~55C°
Range Storage Temperature	-15C°~60C°
Net Weight (Kg)	23.7KG
Product Size (D*W*H)	607×406×141MM
Package Dimension (D*W*H)	712×582×259MM

## INSTALLATION

### Safety Guidance

Warning marks inform users of conditions which can cause serious physical injury or death, or damage to the device. They also tell users how to prevent the dangers. The warning marks used in this operation manual are shown below:

	<ul style="list-style-type: none"> <li>After receiving this product, first confirm the product package is intact. If any question, contact the logistic company or local distributor immediately.</li> <li>The installation and operation of inverter must be carried out by professional technicians who have received professional trainings and thoroughly familiar with all the contents in this manual and the safety requirements of the electrical system.</li> </ul>
	<ul style="list-style-type: none"> <li>Do not carry out connection/disconnection, unpacking inspection and unit replacement operations on the inverter when power source is applied. Before wiring and inspection, users must confirm the breakers on DC and AC side of inverter are disconnected and wait for at least 5 minutes.</li> </ul>
	<ul style="list-style-type: none"> <li>Ensure there is no strong electromagnetic interference caused by other electronic or electrical devices around the installation site.</li> <li>Do not refit the inverter unless authorized.</li> <li>All the electrical installation must conform to local and national electrical standards</li> </ul>
	<ul style="list-style-type: none"> <li>Do not touch the housing of the inverter or the radiator to avoid scald as they may become hot during operation.</li> </ul>
	<ul style="list-style-type: none"> <li>Ground with proper technics before operation.</li> </ul>
	<ul style="list-style-type: none"> <li>Do not open the surface cover of the inverter unless authorized. The electronic components inside the inverter are electrostatic sensitive. Do take proper anti-electrostatic measures during authorized operation.</li> </ul>
	<ul style="list-style-type: none"> <li>The inverter needs to be reliably grounded.</li> </ul>
	<ul style="list-style-type: none"> <li>Ensure that DC and AC side circuit breakers have been disconnected and wait at least 5 minutes before wiring and checking.</li> </ul>

### Unpacking and Inspection

Before installation, please inspect the unit. Be sure that nothing inside the package is damaged. You should have received the following items inside of package:

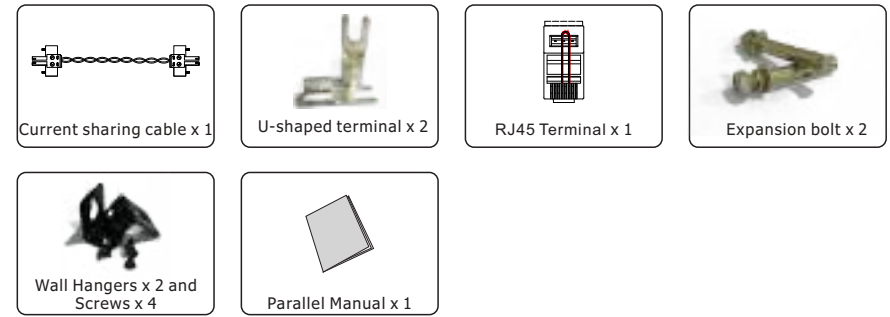
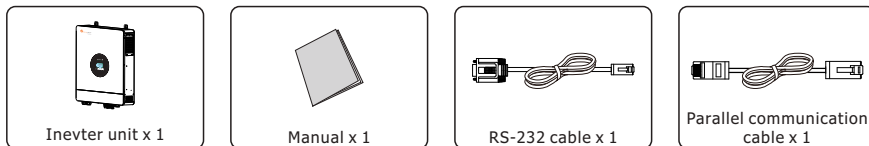

### Preparation

Before connecting all wirings, please take off bottom cover by removing eight screws as shown below.

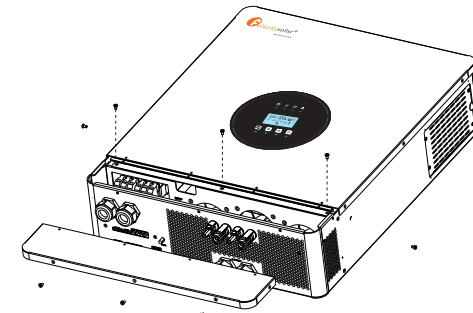

### Mounting the Unit

Consider the following points before selecting where to install:

- Do not mount the inverter on flammable construction materials.
- Mount on a solid surface
- Install this inverter at eye level in order to allow the LCD display to be read at all times.
- The ambient temperature should be between 0°C and 55°C to ensure optimal operation.
- The recommended installation position is to be adhered to the wall vertically.
- Be sure to keep other objects and surfaces as shown in the right diagram to guarantee sufficient heat dissipation and to have enough space for removing wires.

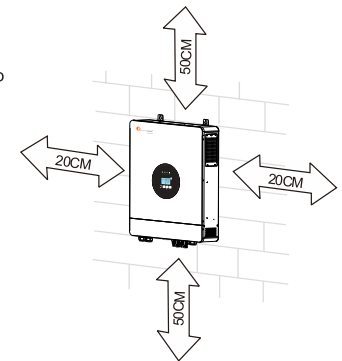

**SUITABLE FOR MOUNTING ON CONCRETE OR OTHER NON-COMBUSTIBLE SURFACE ONLY.**

Install the unit by screwing two screws. It's recommended to use M4 or M5 screws.

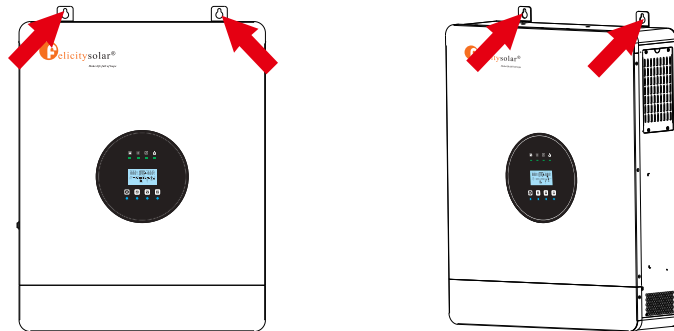

## Battery Connection

**CAUTION:** For safety operation and regulation compliance, it's requested to install a separate DC over-current protector or disconnect device between battery and inverter. It may not be requested to have a disconnect device in some applications, however, it's still requested to have over-current protection installed. Please refer to typical amperage in below table as required fuse or breaker size.

**WARNING!** All wiring must be performed by a qualified personnel.

**WARNING!** It's very important for system safety and efficient operation to use appropriate cable for battery connection. To reduce risk of injury, please use the proper recommended cable and terminal size as below.

**Recommended battery cable and terminal size:**

Model	Wire Size	Cable (mm <sup>2</sup> )	Torque Value(Max)
8KVA	1*1AWG	50	2 Nm

**Please follow below steps to implement battery connection:**

1. Assemble battery ring terminal based on recommended battery cable and terminal size.
2. Connect all battery packs as units requires. It's suggested to connect at least 200Ah capacity battery.
3. Insert the ring terminal of battery cable flatly into battery connector of inverter and make sure the bolts are tightened with torque of 2 Nm. Make sure polarity at both the battery and the inverter/charge is correctly connected and ring terminals are tightly screwed to the battery terminals.

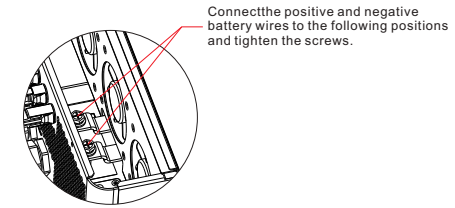

**WARNING: Shock Hazard**

Installation must be performed with care due to high battery voltage in series.



**CAUTION!!** Do not place anything between the flat part of the inverter terminal and the ring terminal. Otherwise, overheating may occur.

**CAUTION!!** Do not apply anti-oxidant substance on the terminals before terminals are connected tightly.

**CAUTION!!** Before making the final DC connection or closing DC breaker/disconnector, be sure positive (+) must be connected to positive (+) and negative (-) must be connected to negative (-).

## AC Input/Output Connection



**CAUTION!!** Before connecting to AC input power source, please install a separate AC breaker between inverter and AC input power source. This will ensure the inverter can be securely disconnected during maintenance and fully protected from over current of AC input, The recommended spec of AC breaker is 63A for 8KVA



**CAUTION!!** There are two terminal blocks with "IN" and "OUT" markings. Please do NOT mis-connect input and output connectors.

**WARNING!** All wiring must be performed by qualified personnel.

**WARNING!** It's very important for system safety and efficient operation to use appropriate cable for AC input connection. To reduce risk of injury, please use the proper recommended cable size as below.

**Suggested cable requirement for AC wires**

Model	Gauge	Cable (mm <sup>2</sup> )	Torque Value
8KVA	8 AWG	10	1.4~ 1.6Nm

**Please follow below steps to implement AC input/output connection:**

1. Before making AC input/output connection, be sure to open DC protector or disconnector first.
2. Remove insulation sleeve 10mm for six conductors. And shorten phase L and neutral conductor N 3 mm.

3. Insert AC input wires according to polarities indicated on terminal block and tighten the terminal screws. Be sure to connect PE protective conductor (⚡) first.

⚡ → **Ground (yellow-green)**  
**L** → **LINE (brown or black)**  
**N** → **Neutral (blue)**

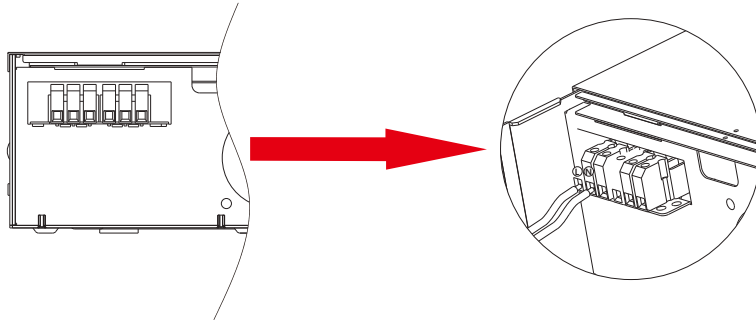
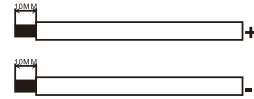

**WARNING:** Be sure that AC power source is disconnected before attempting to hardwire it to the unit.

4. This inverter is equipped with dual-output. There are four terminals (L1/N1, L2/N2) available on output port. It's set up through LCD program or monitoring software to turn on and off the second output. Refer to "LCD setting" section for the details. Insert AC output wires according to polarities indicated on terminal block and tighten terminal screws. Be sure to connect PE protective This inverter is equipped with dual-output. There are four terminals conductor (⚡) first.

⚡ → **Ground (yellow -green)**  
**L1** → **LINE (brown or black)**  
**N1** → **Neutral (blue)**  
**L2** → **LINE (brown or black)**  
**N2** → **Neutral (blue)**

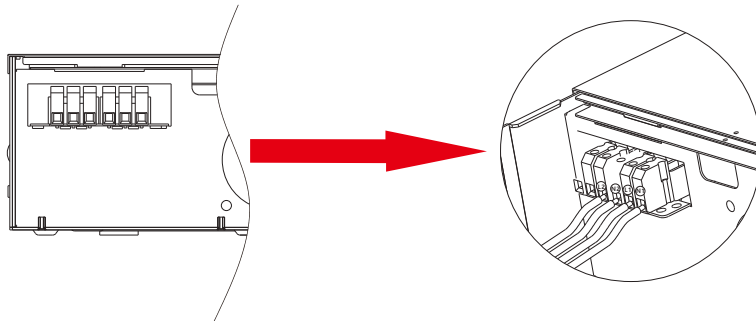
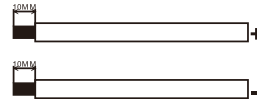

5. Make sure the wires are securely connected.

**CAUTION: Important**

Be sure to connect AC wires with correct polarity. If L and N wires are connected reversely, it may cause utility short-circuited when these inverters are worked in parallel operation.

**CAUTION:** Appliances such as air conditioner are required at least 2~3 minutes to restart because it's required to have enough time to balance refrigerant gas inside of circuits. If a power shortage occurs and recovers in a short time, it will cause damage to your connected appliances. To prevent this kind of damage, please check manufacturer of air conditioner if it's equipped with time-delay function before installation. Otherwise, this inverter/charger will trig overload fault and cut off output to protect your appliance but sometimes it still causes internal damage to the air conditioner.

## PV Connection



**CAUTION:** Before connecting to PV modules, please install separately a 600VDC/30A circuit breaker between inverter and PV modules.

**WARNING!** All wiring must be performed by qualified personnel.

**WARNING!** It's very important for system safety and efficient operation to use appropriate cable for PV module connection. To reduce risk of injury, please use the proper recommended cable size as below.

Model	Cable Size	Cable (mm <sup>2</sup> )	Torque
8KVA	10~12AWG	4~6	1.4~1.6 Nm

### PV Module Selection:

When selecting proper PV modules, please be sure to consider below parameters:

1. Open circuit Voltage (Voc) of PV modules not exceeds max. PV array open circuit voltage of inverter.
2. Max. power voltage (Vmp) should be during PV array MPPT voltage range.

Solar Charging Mode	
<b>INVERTER MODEL</b>	8KVA
<b>Max. PV Array Open Circuit Voltage</b>	500V
<b>PV Array MPPT Voltage Range</b>	100Vdc~450Vdc

Please follow below steps to implement PV module connection:



**Step 1:** Check the input voltage of PV array modules. This system is applied with two strings of PV array. Please make sure that the maximum current load of each PV input connector is 18A.

**CAUTION:** Exceeding the maximum input voltage can destroy the unit!! Check the system before wire connection.

**Step 2:** Disconnect the circuit breaker and switch off the DC switch.

**Step 3:** Assemble provided PV connectors with PV modules by the following steps.

## Components for PV connectors and Tools:

Female connector housing and female terminal	
Male connector housing and male terminal	
Crimping tool and spanner	

Prepare the cable and follow the connector assembly process:

- Strip cable 8 mm on the end sides and be careful NOT to nick conductors.

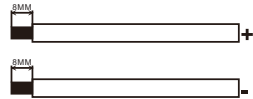

- Insert striped cable into female terminal and crimp female terminal as shown below.

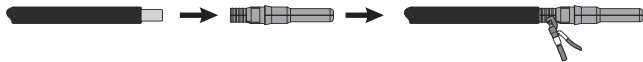

- Insert assembled cable into female connector housing as shown below.

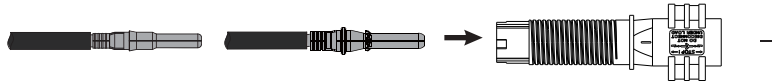

- Insert striped cable into male terminal and crimp male terminal as shown below.

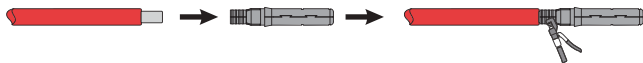

- Insert assembled cable into male connector housing as shown below

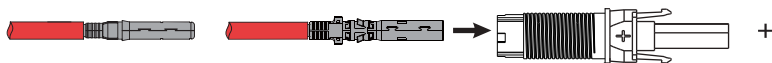

**Step 4:** Check correct polarity of connection cable from PV modules and PV input connectors. Then, connect positive pole (+) of connection cable to positive pole (+) of PV input connector. Connect negative pole (-) of connection cable to negative pole (-) of PV input connector.

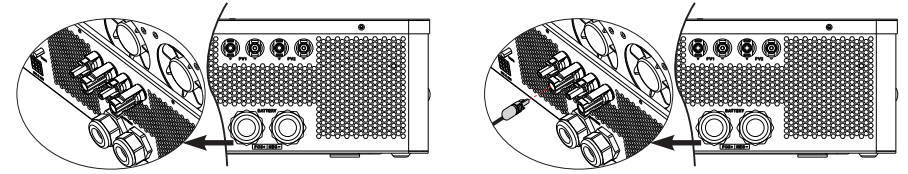

**Step 5:** Make sure the wires are securely connected.

## Final Assembly

After connecting all wirings, please put bottom cover back by screwing eight screws as shown below.

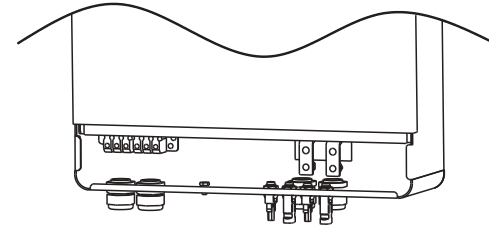

## Dry Contact Signal

There is one dry contact (3A/250VAC) available on the inverter.

Unit Status	Condition	Dry contact port:	
		NC & C	NO & C
Power Off	Unit is off and no output is powered.	Close	Open
	Battery voltage < Setting value in Program 12	Open	Close
Power On	Battery voltage > Setting value in Program 13 or battery charging reaches floating stage	Close	Open

Wiring System for Inverter

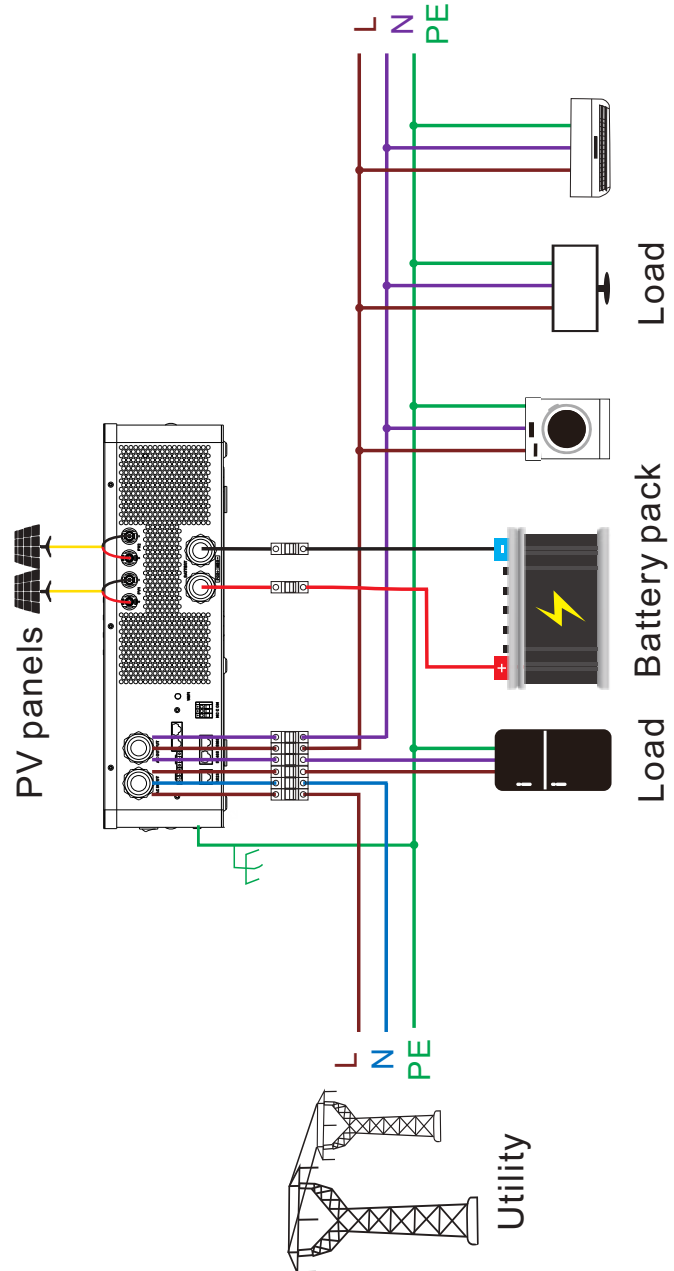

NOTE 1: Before starting up inverters, please connect all N wires of AC output together

NOTE 2: Do not connect the N line of the Utility to the N line of the AC output before starting the inverter

OPERATION  
Power ON/OFF

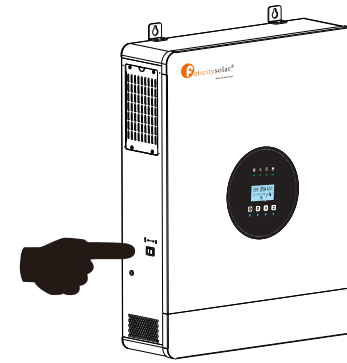

Once the unit has been properly installed and the batteries are connected well, simply press On/Off switch (located on the bottom of the case) to turn on the unit.

Operation and Display Panel

The operation and display panel, shown in below chart, is on the front panel of the inverter. It includes three indicators, four function keys and a LCD display, indicating the operating status and input/output power information.

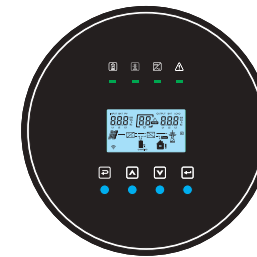

Function Key	Icon	Description
ESC		To previous page
UP		To go to previous selection
DOWN		To go to next selection
ENTER		To confirm the selection or go to next page

LED Indicator	Icon	Description
Battery		Charging the battery, the LED light flash. If battery is full, the LED light will always-on. The battery is not charged, the LED light will go out.
Utility		Inverter running in utility mode, the LED will always-on. Inverter is not running in utility mode, the LED will go out.
Inverter		Inverter running in off-grid mode, the LED light will always-on. Inverter is not running in off-grid mode, the LED light will go out.
Fault		If inverter in fault event, the LED light will always-on. If inverter in warning event, the LED light will flash. Inverter work normally, the LED light will go out.
Buzzer Information		
Buzzer beep		Turn on/off the inverter, the buzzer will last for 2.5s. Press any button, the buzzer will last for 0.1s. Hold on the "ENTER" button, the buzzer will last for 3s. If in fault event, the buzzer will keep going. If in warning event, the buzzer will beep discontinuous (Check more information on the chapter of "Warning Code Table").

## LCD Display Icons

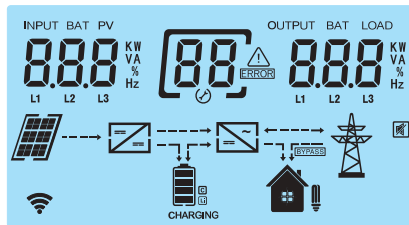

Icon	Function description
Input Source Information	
	Indicate input voltage, input frequency, PV voltage, PV power, battery voltage and charger current.
Configuration Program and Fault Information	
	Indicates the setting programs.
	Indicates the warning and fault codes. Warning:  flashing with warning code. Fault:  lighting with fault code

Output Information	
	Indicate output voltage, output frequency, load percent, load in VA, load in Watt and discharging current.
Battery Information	
	Indicates battery level by 0-24%, 25-49%, 50-74% and 75-100%.
	Indicates Lithium battery type.
	Indicates communication is built between inverter and battery.
Mode Operation Information	
	Indicates the utility.
	Indicates load is supplied by utility directly.
	Indicates the utility charger circuit is working.
	Indicates the inverter/charger is working.
	Indicates the PV panels.
	Indicates PV MPPT is working.
	Indicates the WIFI link
	Indicates the second AC output
Mute Operation	
	Indicates unit alarm is disabled.

## LCD operation flow chart

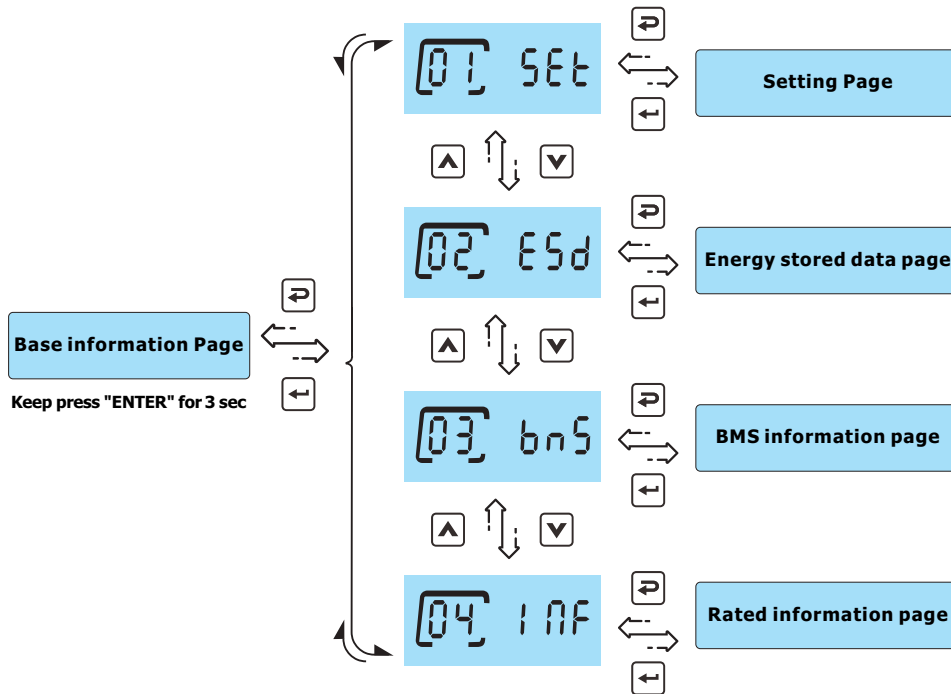

On base information page, pressing and holding "ENTER" key for 3 sec, the unit will enter parameters page. Press "UP" or "DOWN" key to switch the selection and press "ENTER" key to enter selected page. Press "ESC" key to back to previous page.

## Base information Page

The base information will be switched by pressing "UP" or "DOWN" key. The selectable information is switched as below order:

<p><b>Input voltage / Output voltage</b> Utility voltage is 230V, output voltage is 230V</p>	<p><b>Input frequency / Output voltage</b> Utility frequency is 50.0Hz, output voltage is 230V</p>
--	--



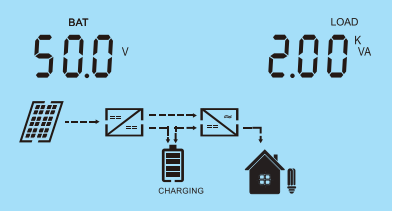
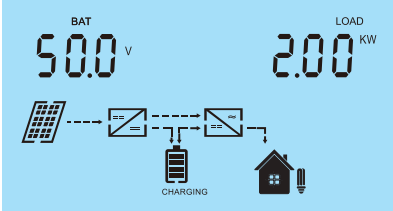
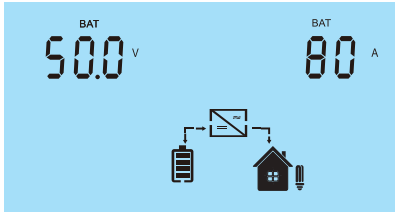
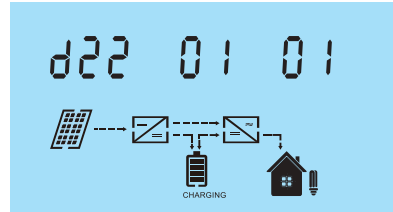
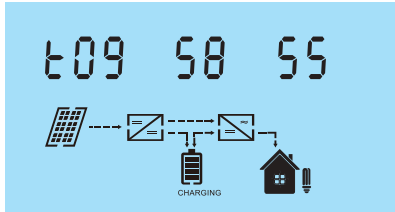







<p><b>PV voltage</b> PV voltage is 360V</p>	<p><b>PV power</b> PV power is 3.00kW</p>
<p><b>PV voltage</b> PV voltage is 360V</p>	<p><b>PV power</b> PV power is 3.00kW</p>
<p><b>Battery voltage / Output voltage</b> Battery voltage is 50.0V, output voltage is 230V</p>	<p><b>Charging current / Output voltage</b> Charging current is 10A, output voltage is 230V</p>
<p><b>Battery voltage / Output frequency</b> Battery voltage is 50.0V, output frequency is 50.0Hz</p>	<p><b>Battery voltage / Load percentage</b> Battery voltage is 50.0V, load percentage is 40%</p>

<p><b>Battery voltage / Load VA</b> Battery voltage is 50.0V, output wattage is 2.00kVA</p> 	<p><b>Battery voltage / Load wattage</b> Battery voltage is 50.0V, output wattage is 2.00kW</p> 
<p><b>Battery voltage / Discharging current</b> Battery voltage is 50.0V, discharging current is 80A</p> 	<p><b>Date</b> 2022-01-01</p> 
<p><b>Time</b> 09: 58: 55</p> 	

## Setting Page

Press "UP" or "DOWN" button to select setting programs. And then, press "ENTER" button to confirm the selection or ESC button to exit.

### Setting items:

		Selectable option	
00	Exit setting		
01	Output voltage setting	220V 	Output voltage configuration
		230V 	
		240V 	
02	Output frequency setting	50Hz 	Output frequency configuration
		60Hz 	
03	Utility input range setting	Appliance mode 	APL should be selected, when the utility is not well.
		UPSmode 	
04	Output source priority	Utility >> PV >> Battery 	Utility provides power to the loads first. PV and battery will provide power to loads only when utility is not available.
		PV >> Utility >> Battery 	PV provides power to the loads first. If PV is not sufficient, utility will supply power the loads at the same time. Battery will provide power to loads only when utility is not available.
		PV >> Battery >> Utility 	PV provides power to the loads first. If PV is not sufficient, battery will supply power to the loads at the same time. Utility provides power to the loads only when battery voltage drops to the setting point in program 12.

05	Charger priority	<b>If inverter is working in utility mode, charger priority can be set as below. However, when inverter is working in Battery mode, only PV can charge battery.</b>	
		PV first CHS [05] C50	PV will charge battery first. Utility will charge battery only when PV is unavailable.
		PV and Utility CHS [05] 50U	PV and utility will charge battery together.
		PV Only CHS [05] 050	Only PV can charge the battery.
06	Max charging current (Utility charge current + PV charging current)	60A bCC [06] 60 <sup>A</sup>	Setting range is from 10A to 150A. Increment of each click is 1A.
07	Max utility charging current setting	30A CHC [07] 30 <sup>A</sup>	Setting range is from 10A to 150A. Increment of each click is 1A.
08	Battery type setting	The battery type is AGM bAt [08] AGn	If "Self-defined" or "Lib" is selected, battery charge voltage and low DC cut-off voltage can be set up in program 9, 10 and 11. If "Lib" is selected, inverter can charge Lithium battery when the Lithium battery need to be activated. Please make sure Lithium battery is connected before you start up inverter. If inverter doesn't connect battery or Lithium battery, do not select "Lib" battery type.
		The battery type is Flooded bAt [08] FLd	
		The battery type is self-defined bAt [08] USE	
		The battery type is Lib bAt [08] LIb	
09	Bulk charging voltage setting (C.V voltage)	[4] [09] 56.4 <sup>v</sup>	If "self-defined" or "Lib" is selected in program 8, this program is enabled. Setting range is from 48.0V to 60.0V. Increment of each click is 0.1V

10	Floating charging voltage	FL4 [10] 54.0 <sup>v</sup>	If "self-defined" or "Lib" is selected in program 8, this program is enabled. Setting range is from 48.0V to 60.0V. Increment of each click is 0.1V
11	Low DC cut-off voltage	bC4 [11] 42.0 <sup>v</sup>	If "self-defined" or "Lib" is selected in program 8, this program is enabled. Setting range is from 42.0V to 54.0V. Increment of each click is 0.1V
12	Setting battery voltage point back to utility when selecting "SBU priority" in program 4	bU4 [12] 46.0 <sup>v</sup>	Setting range is from 44.0V to 54.0V. Increment of each click is 0.1V
13	Setting battery voltage point back to battery mode when selecting "SBU priority" in program 4	bb4 [13] FUL	Battery should be charged to float charging stage.
		bb4 [13] 54.0 <sup>v</sup>	Setting range is from 48.0V to 60.0V. Increment of each click is 0.1V
14	Overload bypass function	Disable LbP [14] d15	If it is enabled, the inverter will switch to utility mode if overload happens in battery mode.
		Enable LbP [14] ENA	
15	Overload restart function	Disable OLr [15] d15	If it is enabled, the inverter will auto restart when overload occurs.
		Enable OLr [15] ENA	
16	Over temperature restart function	Disable OLt [16] d15	If it is enabled, the inverter will auto restart when over temperature occurs.
		Enable OLt [16] ENA	

17	Backlight of LCD	Disable bL [17] d15	If selected, LCD backlight will be off after no button is pressed for 60s.
		Enable bL [17] ENA	If selected, LCD backlight will be always-on.
18	Auto return to the first page of display screen	Disable bFP [18] d15	If selected, the display screen will stay at latest screen user finally switches.
		Enable bFP [18] ENA	If selected, it will automatically return to the first page of display screen (Input voltage/ output voltage) after no button is pressed for 60s.
19	Buzzer Alarm	Disable bEP [19] d15	If selected, buzzer is not allowed to beep.
		Enable bEP [19] ENA	If selected, buzzer is allowed to beep.
20	Feeding power to grid	Disable FPG [20] d15	If selected, inverter is not allowed to feed exceeding solar power to grid.
		Enable FPG [20] ENA	If selected, inverter is allowed to feed exceeding solar power to grid.
21	Energy stored data for PV and Load	Disable ESd [21] d15	If selected, inverter will erase all historical data of PV and Load energy, and stop record historical data for PV and Load energy.
		Enable ESd [21] ENA	If selected, inverter will record historical data for PV and Load energy. NOTE: Before selected, please double check if date and time is correct, if incorrect, please set date and time in program 22~27.
22	Time setting- Year	Year yEA [22] 22	Setting rage is from 22 to 99.
23	Time setting- Month	Month n0n [23] 1	Setting rage is from 1 to 12



24	Time setting- Day	Day dAY [24] 1	Setting rage is from 1 to 31
25	Time setting- Hour	Hour HOu [25] 9	Setting rage is from 0 to 23
26	Time setting- Minute	Minute n 1n [26] 58	Setting rage is from 0 to 59
27	Time setting- Second	Second SEC [27] 30	Setting rage is from 0 to 59
29	Solar parallel function	SPE [29] d15	Example Cancel MPPT power balance monitoring
		SPE [29] ENA	Power balance monitoring using MPPT
30	Star time setting-Hour		During the period set by program 30,31,32 and 33, it will be turned off if any setting value in program 34,35 or 36 is reached.
		StH [30] 6	Setting rage is from 0 to 23.Increment of each click is 1 hour.
31	Star time setting-Minute	Stn [31] 25	Setting rage is from 0 to 59.Increment of each click is 1 minute.
32	End time setting-Hour	ENH [32] 2	Setting rage is from 0 to 23.Increment of each click is 1 hour.
33	End time setting-Minute	ENn [33] 30	Setting rage is from 0 to 59.Increment of each click is 1 minute.
34	Setting discharge time on the second output (L2) if "Single" is selected in program 28.	t1n [34] 14	Setting range is from 0 to 25. Increment of each click is 1 hour.25 indicates normally open. *If the battery discharge time achieves the setting time in program 30,31,32 and 33 and the program 35 or 36 function is not triggered, the output will be turned off.

35	Setting cut-off voltage point on the second output (L2) if "Single" is selected in program 28.	n14 <span style="border: 1px solid black; padding: 2px;">35</span> 511	If "User-defined" is selected in program 08, this setting range is from 42.0V to 54.0V for 48V model. Increment of each click is 0.1V.
36	Setting SOC percentage on the second output (L2) if "Single" is selected in program 28.	n15 <span style="border: 1px solid black; padding: 2px;">36</span> 25	If any type of lithium battery is selected in program 08, this parameter value will be displayed in percentage and value setting is based on battery capacity percentage. Setting range is from 0% to 95%. Increment of each click is 5%.

### Energy stored data Page

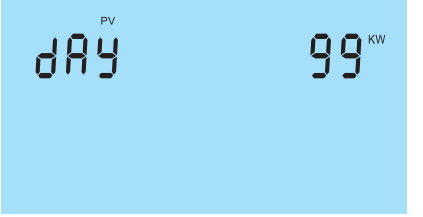
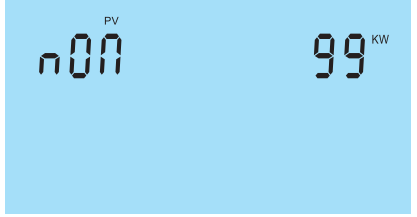
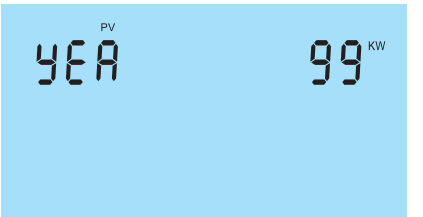
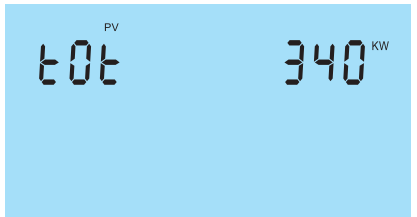
The energy stored data will be switched by pressing "UP" or "DOWN" key. The selectable information is switched as below order:

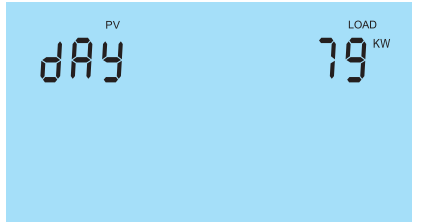
<b>PV generated energy today</b> 99 kWh 	<b>PV generated energy this month</b> 99 kWh 
<b>PV generated energy this year</b> 99 kWh 	<b>PV generated energy current in total</b> 340 kWh 

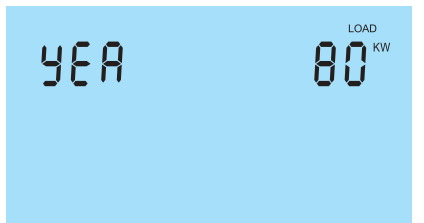
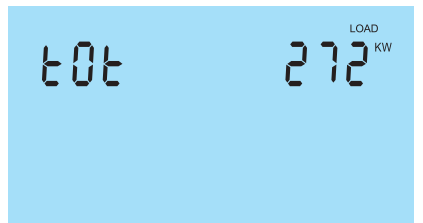
<b>Load consumed energy today</b> 79 kWh 	<b>Load consumed energy this month</b> 79 kWh 
<b>Load consumed energy this year</b> 80 kWh 	<b>Load consumed energy in total</b> 272 kWh 

### BMS information Page

The BMS information will be switched by pressing "UP" or "DOWN" key. The selectable information is switched as below order:

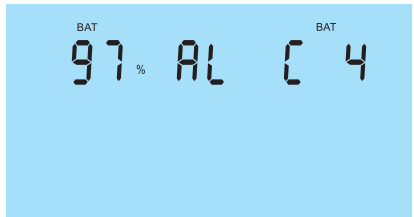
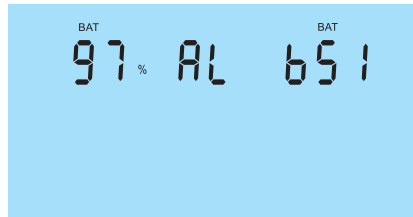
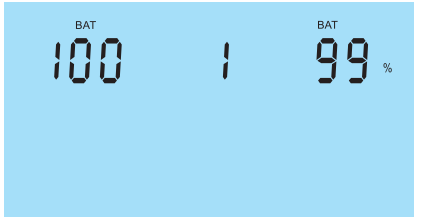
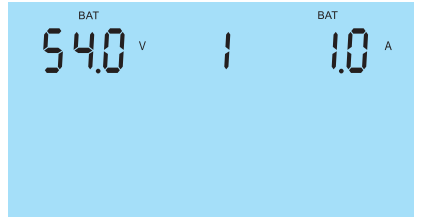
<b>Mean SOC/ Battery pack number / BMS status</b> Mean SOC is 97%, Connected Battery pack number is 4, BMS status is 51 (Check detail in warning code table). If BMS status occurred, it will be rolled with battery pack number automatically.  	
<b>BMS version / SOC</b> BMS version is 100, SOC is 99% on battery pack of address 1 	<b>BMS voltage / current</b> BMS voltage is 54.0V, current is 1A on battery pack of address 1 

**BMS highest temperature / lowest temperature**

BMS highest temperature is 25°C , lowest temperature is -10°C on battery pack of address 1

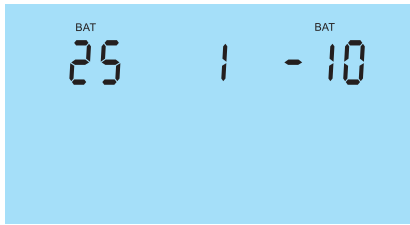

**BMS fault code / flag**

BMS fault code is 0, flag is 000 on battery pack of address 1

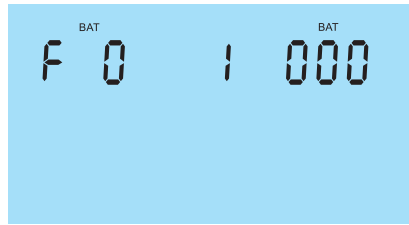

**Rated information Page**

The rated information will be switched by pressing "UP" or "DOWN" key. The selectable information is switched as below order:

**Rated VA / WATT**

Rated VA is 5KVA, WATT is 5KW

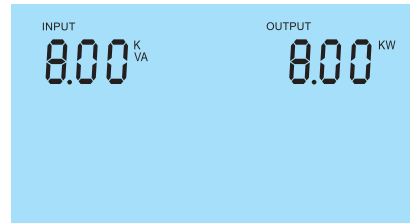

**Rated battery voltage / Max. charge current**

Rated battery voltage is 48V, Max. charge current is 100A

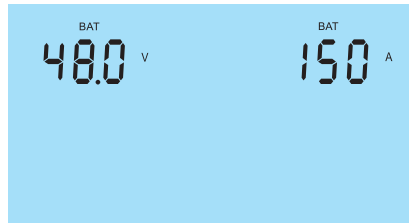

**Firmware version**

Firmware version is 1400

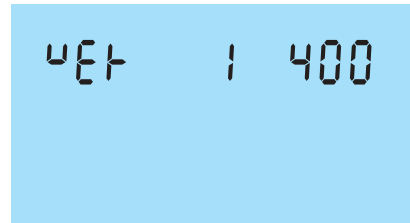

**Lithium Battery Communication**

It's allowed to connect lithium battery and build communication only which it has been configured. Please follow below steps to configure communication between lithium battery and inverter.

1. Connect power cables between lithium battery and inverter. Please pay attention to the terminals of positive and negative. Make sure the positive terminal of battery is connected to the positive terminal of inverter, and the negative terminal of battery is connected to the negative terminal of inverter.
2. The communication cable is bundled with lithium battery. Both sides are RJ45 port. One port is connected to the BMS port of inverter and another one is connected to the COMM port of lithium battery.

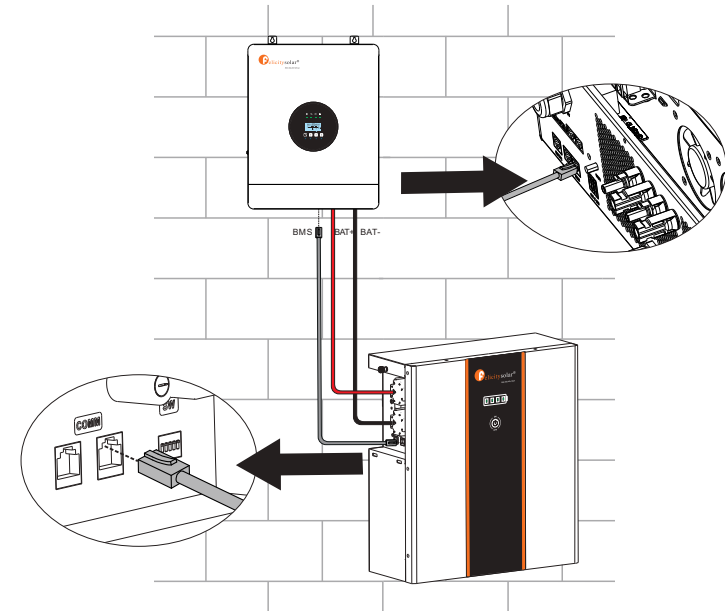

3. Configure battery type to "Lib" in LCD setting No. 08.

The battery type is Lib



And then LCD will show you "Li" icon.

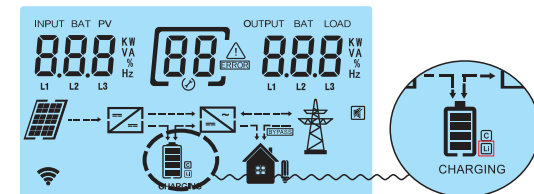

4. Power up lithium battery and inverter. Wait a moment, if the communication is built between them, LCD will show you "C" icon as below.

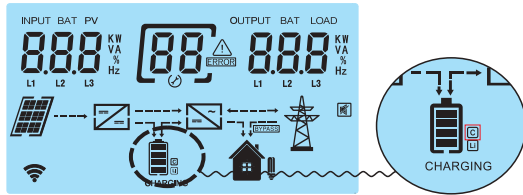

5. Roll LCD real time information pages by pressing "UP" or "DOWN" button, as below page, you can see the parameters of SOC and battery pack units in the communication system.

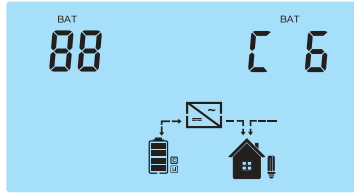

This page means SOC is 88% and battery pack units are 6.

## Parallel Installation Guide

### 1. Introduction

This inverter can be used in parallel with two different operation modes.

1. Parallel operation in single phase with up to 6 units. The supported maximum output power is 48KW/48KVA .
2. Maximum twelve units work together to support three-phase equipment. Ten units support one phase maximum. The supported maximum output power is 48KW/48KVA and one phase can be up to 40KW/40KVA.

**NOTE 1:** If this unit is bundled with share current cable and parallel cable, this inverter is default supported parallel operation. You may skip section 2.

**NOTE 2:** Under parallel operation modes, battery must be connected with inverters.

**NOTE 3:** Before starting up inverters, please connect all N wires of AC output together.

### 2. Mounting the Unit

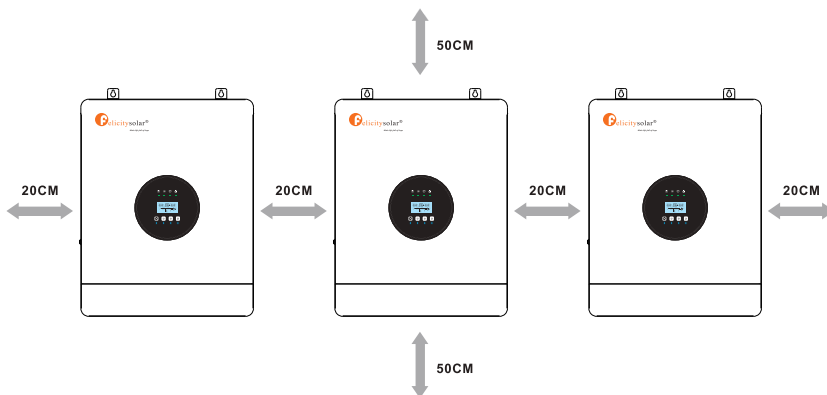

**NOTE:** For proper air circulation to dissipate heat, allow a clearance of approx. 20 cm to the side and approx. 50 cm above and below the unit. Be sure to install each unit in the same level.

## Single Phase Parallel connection diagram for three inverters in parallel

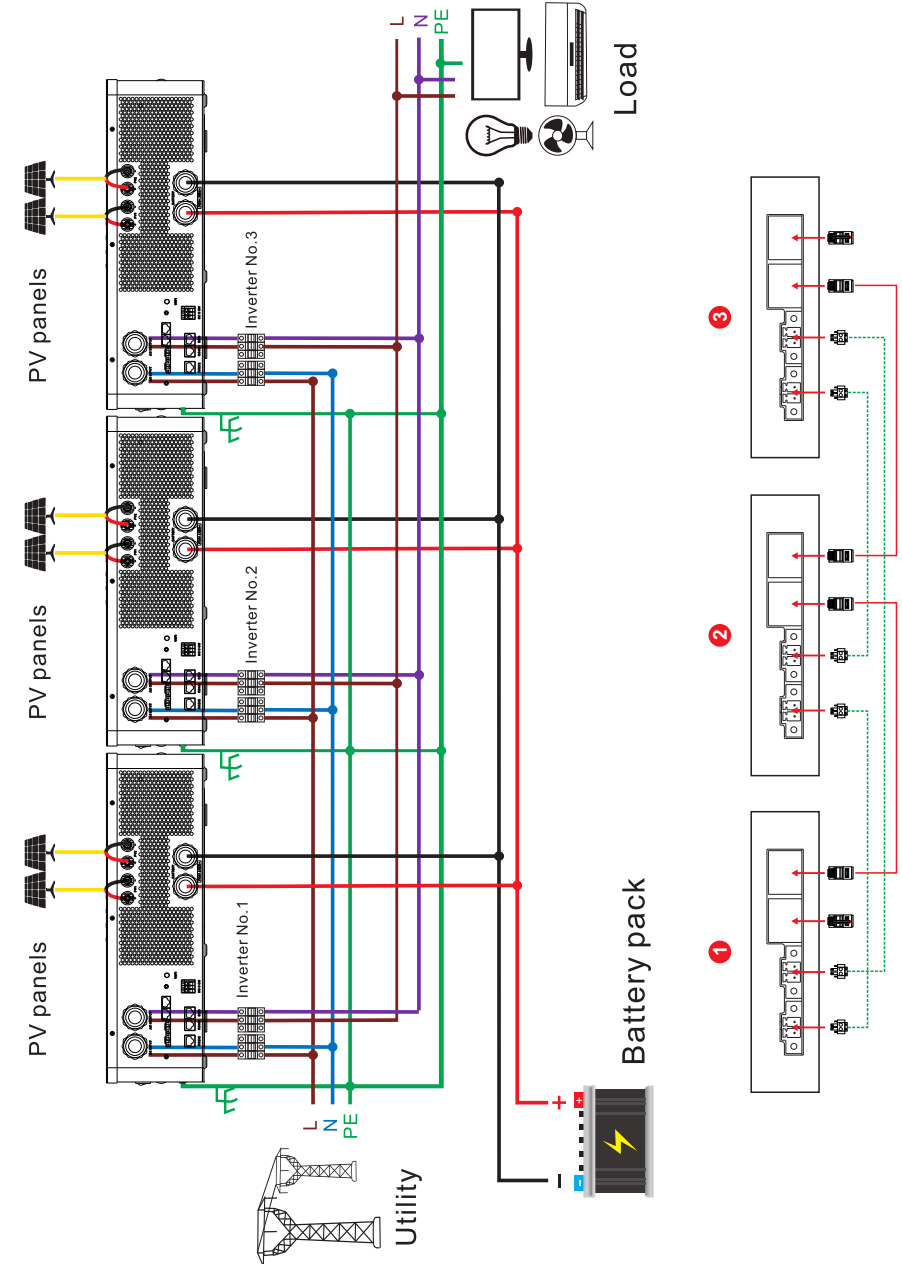

**NOTE 1:** Before starting up inverters, please connect all N wires of AC output together

**NOTE 2:** Do not connect the N line of the Utility to the N line of the AC output before starting the inverter

Three Phase Parallel connection diagram for three inverters in parallel

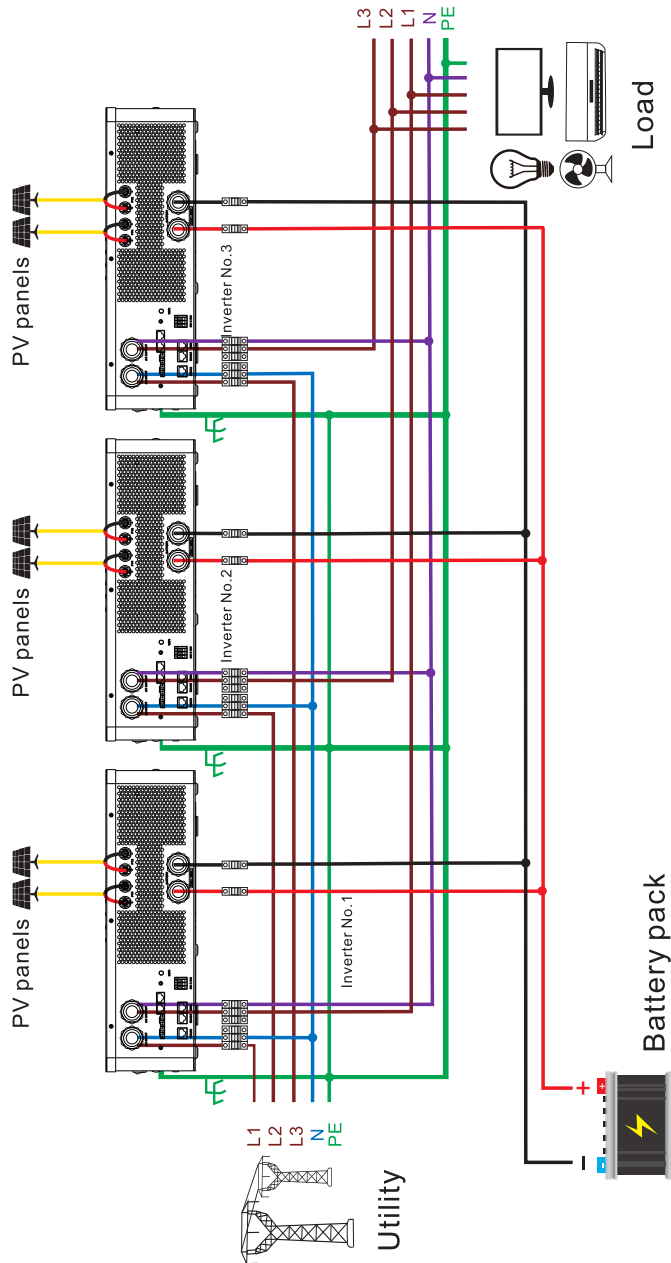

NOTE 1: Before starting up inverters, please connect all N wires of AC output together

NOTE 2: Do not connect the N line of the Utility to the N line of the AC output before starting the inverter

3. LCD Setting and Display

Setting Program

28	AC output mode	Single [28] 510	<p>When the units are used in parallel with single phase, please select "PAL" in program 28.</p> <p>It is required to have at least 3 inverters or maximum twelve inverters to support three-phase equipment.</p> <p>It's required to have at least one inverter in each phase or it's up to ten inverters in one phase.</p> <p>Please select "3P1" in program 28 for the inverters connected to L1 phase, "3P2" in program 28 for the inverters connected to L2 phase and "3P3" in program 28 for the inverters connected to L3 phase.</p> <p>Do NOT connect share current cable between units on different phases.</p> <p>Before starting up inverters, please connect all N wires of AC output together.</p>
		Parallel [28] PAL	
		L1 Phase [28] 3P1	
		L2 Phase [28] 3P2	
		L3 Phase [28] 3P3	

4. Commissioning

Parallel in single phase

Step 1: Check the following requirements before commissioning:

- Correct wire connection.
  - Ensure all breakers in Line wires of load side are open and each Neutral wires of each unit are connected together.
- Step 2: Turn on each unit and set "PAL" in LCD setting program 28 of each unit. And then shut down all units.

NOTE: To be safe, it's better to turn off switch when setting LCD program.

Step 3: Turn on each unit.

<p>LCD display in Master unit</p>	<p>LCD display in Slave unit</p>
-----------------------------------	----------------------------------

**NOTE:** Master and slave units are randomly defined.

Step 4: Switch on all AC breakers of Line wires in AC input. It's better to have all inverters connect to utility at the same time. However, these inverters will automatically restart. If detecting AC connection, they will work normally.

LCD display in Master unit	LCD display in Slave unit

Step 5: If there is no more fault alarm, the parallel system is completely installed.

Step 6: Please switch on all breakers of Line wires in load side. This system will start to provide power to the load.

### Support three-phase equipment

Step 1: Check the following requirements before commissioning:

- Correct wire connection
- Ensure all breakers in Line wires of load side are open and each Neutral wires of each unit are connected together.

Step 2: Turn on all units and configure LCD program 28 as P1, P2 and P3 sequentially. And then shut down all units.

**NOTE:** To be safe, it's better to turn off switch when setting LCD program.

Step 3: Turn on all units sequentially.

LCD display in L1-phase unit	LCD display in L2-phase unit	LCD display in L3-phase unit

Step 4: Switch on all AC breakers of Line wires in AC input. If AC connection is detected and three phases are matched with unit setting, they will work normally. Otherwise, the AC icon  will flash and they will not work in line mode.

LCD display in L1-phase unit	LCD display in L2-phase unit	LCD display in L3-phase unit

Step 5: If there is no more fault alarm, the system to support 3-phase equipment is completely installed.

Step 6: Please switch on all breakers of Line wires in load side. This system will start to provide power to the load.

Note 1: To avoid overload occurring, before turning on breakers in load side, it's better to have whole system in operation first.

Note 2: Transfer time for this operation exists. Power interruption may happen to critical devices, which cannot bear transfer time.

## Warning Code Table

When fault event happens, the fault LED is flashing. At the same time, warning code, icon  is shown on the LCD screen.

Warning Code	Warning Information	Audible Alarm	Trouble Shooting
01	Fan is locked.	Beep three times every second	Check if the Fans wiring connected well. Replace the fan.
02	Overload	Beep twice every second	Reduce the loads.
03	Low battery	Beep once every second	The battery voltage is too low, it should be charging.
50	BMS firmware version is not matched.		Upgrade the firmware of BMS.
51	BMS doesn't allow inverter to charge battery.		Inverter will stop charging battery automatically.
52	BMS doesn't allow inverter to discharge battery.		Inverter will stop discharging battery automatically.
53	BMS require inverter to charge battery.		Inverter will charge battery automatically.
54-65	BMS detect something wrong happened.		If the code is keeping for long time, please contact with your installer.

## Fault Code Table

When fault event happens, inverter will cut off output, and the fault LED is solid on. At the same time, fault code, icon  and **ERROR** are shown on the LCD screen.

Fault Code	Fault information	Trouble Shooting
01	Bus voltage is too high	AC Surge or internal components failed. Restart the unit, if the error happens again, please return to repair center.
02	Bus voltage is too low	Restart the unit, if the error happens again, please return to repair center.
03	Bus soft start fail	Internal components failed. Restart the unit, if the error happens again, please return to repair center.
04	Inverter soft start fail	Internal components failed. Restart the unit, if the error happens again, please return to repair center.
05	Over current or surge detected by Software	Restart the unit, if the error happens again, please return to repair center.
06	Over current or surge detected by hardware	Restart the unit, if the error happens again, please return to repair center.

07	Output voltage is too low	Reduce the connected load. Restart the unit, if the error happens again, please return to repair center.
08	Output voltage is too high	Restart the unit, if the error happens again, please return to repair center.
09	Output short circuited	Check if wiring is connected well and remove abnormal load.
10	Overload time out	Reduce the connected load by switching off some equipment.
11	Battery voltage is too high	Check if spec and quantity of batteries are meet requirements.
12	Over current happen at DC/DC circuit	Restart the unit, if the error happens again, please return to repair center.
13	PV voltage is too high	Reduce the number of PV modules in series.
14	Short circuited happen at PV port	Check if wiring is connected well.
15	PV power is abnormal	Reduce the number of PV modules.
16	Over current happen at PV port	Restart the unit, if the error happens again, please return to repair center.
17	Fan is locked	Check if wiring is connected well. Replace the fan.
18	Over temperature happen at PV circuit	The temperature of internal PV component is over the limitation. Check whether the air flow of the unit is blocked or whether the ambient temperature is too high.
19	Over temperature happen at Convert L circuit	The temperature of Convert L battery converter component is over the limitation. Check whether the air flow of the unit is blocked or whether the ambient temperature is too high.
20	Over temperature happen at INV circuit	The temperature of internal INV component is over the limitation. Check whether the air flow of the unit is blocked or whether the ambient temperature is too high.
21	The inner temperature over	The inner temperature is over the limitation. Check whether the air flow of the unit is blocked or whether the ambient temperature is too high.
22	DCDC current sensor failed	Restart the unit, if the error happens again, please return to repair center.
23	No.2 DCDC current sensor failed	Restart the unit, if the error happens again, please return to repair center.
24	Inverter current sensor failed	Restart the unit, if the error happens again, please return to repair center.
25	OP current sensor failed	Restart the unit, if the error happens again, please return to repair center.
26	Sharing current sensor failed	Restart the unit, if the error happens again, please return to repair center.

27	The AC input and output wires are inversely connected	1. Please check AC input and output wires are connected correctly. 2. If this error happens during parallel installation, please check wires connection. If they are connected correctly, please finish parallel installation first, and then restart inverters. 3. If the problem remains, please contact your installer.
28	Single unit is installed to parallel system	1. Please check if single unit is installed to parallel system. 2. If this error happens during parallel installation, please check wires connectioin. If they are connected correctly, please finish parallel installation first, and then restart inverters. 3. If the problem remains, please contact your installer.
29	DC/DC soft start fail.	Restart the unit, if the error happens again, please return to repair center.
31	Over temperature happen at convert H circuit	The temperature of internal convert H component is over the limitation. Check whether the air flow of the unit is blocked or whether the ambient temperature is too high.
32	Over temperature happen at LLC TX	The temperature of internal DC/DC TX is over the limitation. Check whether the air flow of the unit is blocked or whether the ambient temperature is too high.
33	Over current happen at LLC circuit	Restart the unit, if the error happens again, please return to repair center
40	CAN data loss	1. Check if communication cables are connected well and restart the inverter. 2. If the problem remains, please contact your installer.
41	Host data loss	
42	Synchronization data loss	
43	Current feedback into the inverter is detected.	1. Restart the inverter. 2. Check if L/N cables are not connected reversely in all inverters. 3. For parallel system in single phase, make sure the sharing cables are connected in all inverters. For supporting three-phase system, make sure the sharing cables are connected in the inverters in the same phase, and disconnected in the inverters in different phases. 4. If the problem remains, please contact your installer.
44	The firmware version of each inverter is not the same.	1. Update all inverter firmware to the same version. 2. Check the version of each inverter via LCD setting and make sure the CPU versions are same. If not, please contact your installer to provide the firmware to update. 3. After updating, if the problem still remains, please contact your installer.
45	The output current of each inverter is different.	1. Check if sharing cables are connected well and restart the inverter. 2. If the problem remains, please contact your installer.
46	AC output mode setting is different.	1. Switch off the inverter and check LCD setting program 28. 2. For parallel system in single phase, make sure no 3P1, 3P2 or 3P3 is set on program 28. For supporting three-phase system, make sure no "PAL" is set on program 28. 3. If the problem remains, please contact your installer.