

MUST[®]

Rechargeable LiFePO4 Battery
LP1600 Series
User Manual

WARNINGS AND SAFETY PRECAUTIONS

1.SAFETY PRECAUTIONS



- 1) Before installing or using the battery, it is essential to read the user manual carefully. Failure to do so or to follow any instructions or warnings in this document may result in electric shock, serious injury or death, or may damage the battery, potentially rendering it inoperable.
- 2) If the battery is stored for a long time, it must be charged every six months, and the SOC (state of charge) should be no less than 30%.
- 3) The battery must be charged within 12 hours, after total discharge.
- 4) Do not install the product outdoors or beyond the operating temperature or humidity range listed in the manual.
- 5) Do not expose the cable to the outside.
- 6) Do not connect the power terminal reversely.
- 7) All battery terminals must be disconnected for maintenance.
- 8) Please contact the supplier within 24 hours if something abnormal happens.
- 9) Do not use detergent to clean the battery.
- 10) Do not expose batteries to flammable or harsh chemicals or vapours.
- 11) Do not paint any part of the battery, including internal or external components.
- 12) Do not connect the battery with PV solar wiring directly.
- 13) Any foreign object is prohibited from being inserted into any battery part.



Li-ion



WARNINGS AND SAFETY PRECAUTIONS(Continued)



1.1 Before connecting the Battery:

- a. After unpacking, please check the product and packing list first please get in touch with Your local dealer if the product is damaged or missing parts.
- b. Before installation,switch the grid power off and ensure the battery is in the turned off mode.
- c. Wiring must be correct, do not mistake the positive and negative cables ,and ensure no short circuit with the external device.
- d. It is forbidden to connect the battery and AC power directly.
- e. The battery-embedded BMS(Battery Management system) is designed for single battery voltage.Please do not connect the battery in series.
- f. Please ensure that the electrical parameters of the battery system are compatible with related equipment.
- g. Keep the battery away from water and fire.

1.2 Before using the Battery:

- a. If you need to move or repair the battery system,switch the power supply off and turn the battery off completely.
- b. It is forbidden to connect the battery with different types of batteries.
- c. Connecting the battery with a faulty or in-compatible inverter is forbidden.
- d. It is forbidden to disassemble the battery (the QC label falls off or is damaged).
- e. Please do not open, repair ,or disassemble the battery except for qualified technicians from your seller or authorised by your seller. We do not undertake any consequences or related responsibility which because of violation of safety operation or violating of design, production, and equipment safety standards.

INTRODUCTION

Switched Lithium Iron Phosphate Battery is a new energy storage product which can provide reliable power support for various equipment and systems.

Switched Lithium Iron phosphate battery has a built-in BMS(Battery Management system), which can manage and monitor battery voltage, current, temperature and other information.

HIGHLIGHTS

- High-cycle Life
- Longer service Life
- Built-in circuit protection
- Low discharge rate
- Quick recharge
- Supports parallel operation

PACKAGE CONTENTS

- Lithium Iron Phosphate Battery
- Single Battery Pack:
 - 2 x Communication cable
 - 4 x Open Terminal
 - 1x Installation Mountina Rack and Expansion Screws
- 1 x Instruction Manual

TOOLS REQUIRED FOR INSTALLATION

Tools that are required for installation (Tools and consumables are not provided);

- Wire cutters
- Crimping Modular pliers.
- Screwdriver

SPECIFICATIONS

parameter	Data sheet	
nominal voltage	25.6V	51.2V
Discharge voltage	21.6-29.2V	43.2-58.4V
Charging voltage	29.2V	58.4V
Recommended charging	0.5C	
Max charging current	50A/100A/150A/200A	
Recommended discharging current	0.5C	
Max discharging current	50A/100A/150A/200A	
Communication	RS485/RS232/CAN	
depth of discharge	95%	
Working Temperature	0°C ~ 45°C Charge	
	-10°C ~ 45°C Discharge	
The shelf temperature	0°C ~ 35°C	
IP degree	IP 21	
Humidity	5 ~ 95%(RH)	
elevation	< 4000m	
Certificates	CE/UN38.3/MSDS	

IDENTIFYING PARTS

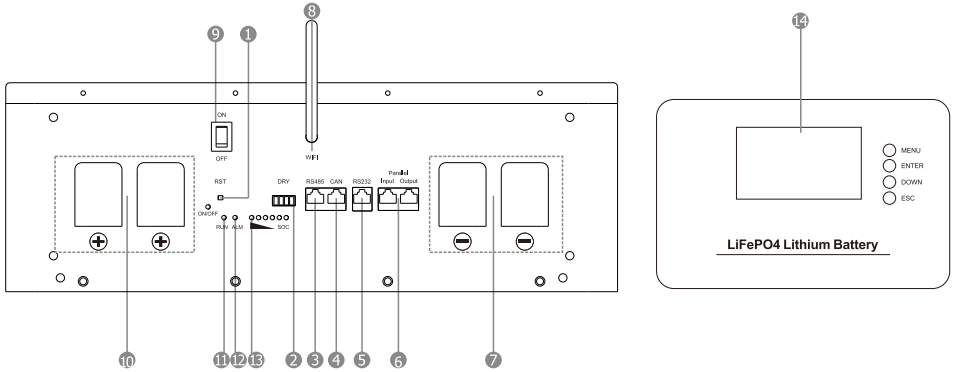

- | | |
|-----------------|------------------|
| 1.RST | 8.WiFi antenna |
| 2.DRY port | 9.Power switch |
| 3.RS485 port | 10.BAT+ |
| 4.CAN port | 11.RUN Indicator |
| 5.RS232 port | 12.ALM Indicator |
| 6.Parallel port | 13.SOC Indicator |
| 7.BAT- | 14.LCD screen |

Short description of identifying parts(Detailed description found in settings and descriptions).

- 1.RST: When the BMS is dormant, press the button (3~6S) to release, the protection plate is activated, and the LED indicator light starts from "RUN" for 0.5 seconds. When the BMS is active, press the button (3~6S) and release, the protection plate is dormant, and the LED indicator starts from the lowest power light for 0.5 seconds. When the BMS is active, press the button(6~10S) and release it, the protection plate is reset, and the LED lights are all lit for 1.5 seconds.
- 2.DRY port.
- 3.RS485 communicationports .
- 4.CAN port.
- 5.RS232 port: RS232 connecting with upper computer to let manufacturer or professional engineer to process adjusting service
- 6.Parallel port
- 7.BAT-:Terminal connector.
- 8.WIFI antenna
9. Power switch.
- 10.BAT+:Terminal connector.
- 11.RUN Indicator: Green LED indicates the battery's running status.
- 12.Alarm Indicator: Red LED Flashing indicates the battery alarm .
- 13.SOC Indicator: SOC-six Green LEDs indicate the battery's current capacity
- 14.LCD screen : Display battery parameters and status information.

SETTINGS AND DESCRIPTIONS

BMS Communication Protocol Settings

In the "Para Setting" section, the display screen has the function of setting the BMS protocol.

Users can view and select the required communication protocol through buttons, and send the selected protocol version number back to the BMS motherboard program, thereby changing the communication protocol between the BMS and inverter.

1) Under the main interface shown in Figure 1-1, select the down key and place the front cursor "》" "

in the "Para Setting" column. Enter key to enter as shown in Figure 1-1. At this time, place the front cursor "》" "in the "Current Prot" column. Enter key to enter as shown in Figure 1-2 to view the current default communication protocol.

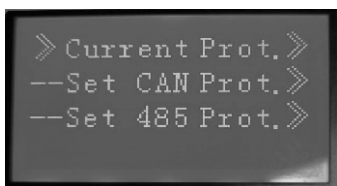

Figure 1-1

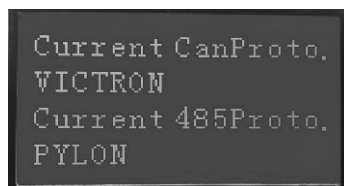

Figure 1-2

2) Set CAN communication protocol

Under the interface shown in Figure 1-1, select downwards with the Down key, place the front cursor "》" "in the "Set CAN Prot" column, and press the Enter key to enter Figure 1-2.1.

In the interface of Figure 1-2.1, the communication protocol for the requirement can be selected by pressing the Down key. Place the cursor "》" "in the corresponding column of the protocol name for the requirement, and press the Enter key Enter the protocol settings, as shown in Figure 1-2.2. At this time, select "PYLON" to set the communication protocol, and press the Enter key to select "YES" to enter the successful setting interface, as shown in Figure 1-2.3. Press the ESC key to return to the previous interface.

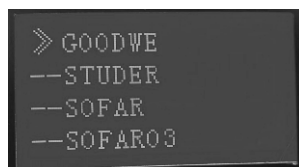

Figure 1-2.1

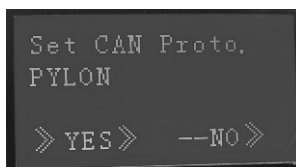

Figure 1-2.2

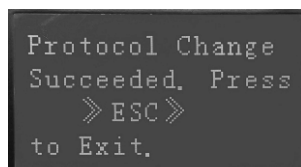

Figure 1-2.3

3) Set RS485 communication protocol

Under the interface shown in Figure 1-1, select downwards using the Down key, place the front cursor "》" "in the "Set 485 Prot" column, and enter the Enter key to set the corresponding RS485 communication protocol. The operation steps are the same as setting the CAN communication protocol.

SETTINGS AND DESCRIPTIONS (Continued)

DRY Contact Output Description:

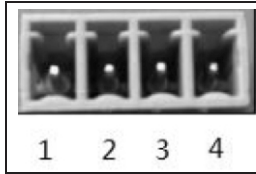

1. Dry contact 1 -PIN 1 to PIN 2: normally open, low battery closed.
2. Dry contact 2 -PIN3 to PIN 4: normally open, closed during fault protection .

RS485 and CAN: For an Inverter and a Secondary Battery:

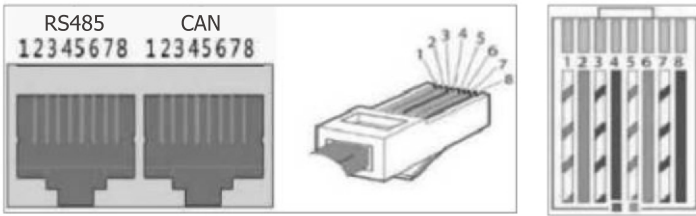

Communication port Definition:

Port	Definition	
RS485 Communication Port Definition	PIN 1	RS485-B
	PIN 2	RS485-A
	PIN 3	GND
	PIN 4	NC(Empty)
	PIN 5	NC(Empty)
	PIN 6	GND
	PIN 7	RS485-A
	PIN 8	RS485-B

Port	Definition	
CAN Communication port Definition	PIN 1	NC(Empty)
	PIN 2	GND
	PIN 3	NC(Empty)
	PIN 4	CANH
	PIN 5	CANL
	PIN 6	NC(Empty)
	PIN 7	NC(Empty)
	PIN 8	NC(Empty)

SETTINGS AND DESCRIPTIONS (Continued)

Battery pack parallel function:

- a. Use a parallel communication cable to connect the parallel output interface of the host machine to the interface of the first slave machine, and then connect the parallel output interface of the first slave machine to the parallel input interface of the second slave machine. Connect in sequence according to the above method.
- b. When parallel status, only the primary battery pack communicate with the PC upper computer as remote monitoring, uploading data, displaying status and any other info of all battery packs.

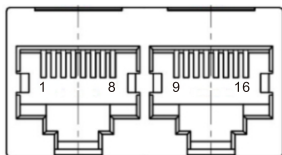

Parallel port

Parallel Output RJ45		Parallel Input RJ45	
Pin	Clarifying	Pin	Clarifying
1、 8	RS485-B	9、 16	RS485-B
2、 7	RS485-A	10、 15	RS485-A
3、 6	GND	11、 14	GND
4	GND	13	UP_IN
5	DN_OP+	12	GND

SETTINGS AND DESCRIPTIONS (Continued)

RS232(Adjusting):

RS232 connecting with upper computer to let manufacturer or professional engineer to process adjusting service

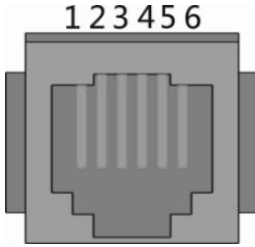

RS232 Port

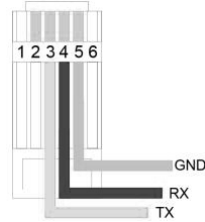

Port	Clarifying	
RS232 Communication port Difinition	PIN 1	NC(Empty)
	PIN 2	NC(Empty)
	PIN 3	TX protection board sending data (PC receiving data)
	PIN 4	RX protection board receiving data (PC Sending data)
	PIN 5	GND
	PIN 6	NC(Empty)

SETTINGS AND DESCRIPTIONS (Continued)

LED Instructions

Condition	RUN	ALR	1	2	3	4	5	6
OFF	-	-	-	-	-	-	-	-
ON	●	●	●	●	●	●	●	●
NORMAL	■	-	-	-	-	-	-	-
Charge	●	-	Show soc					
Discharge	■		Show soc					
Alarm	ALM ■ Other LEDs are same as above.							
System fault or protection	-	●	-	-	-	-	-	
● / ●	ON							
■	flash, on: 0.3s; off: 3.7s							
■ ■	flash, on:0.5s; off: 1.5s							

BMS basic function

Protection and alarm	Management and monitor
Charge/Discharge End	Cells Balance
Charge Over Voltage	Intelligent Charge Model
Discharge Under Voltage	Charge/Discharge Current Limit
Charge/Discharge Over Current	Capacity Retention Calculate
High/Low Temperature(cell/BMS)	Administrator Monitor
Short Circuit	Operation Record
	Power Cable Reverse
	Soft start of inverter

SAFE HANDLING GUIDE OF LITHIUM BATTERIES

Schematic Diagram of Solution:

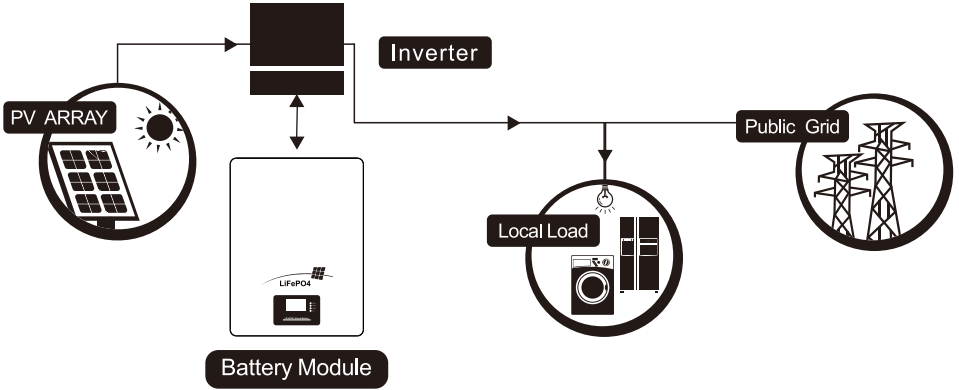

Danger Label:

DANGER

DANGER LOW DC VOLTAGE INSIDE
DANGER ARC FLASH & SHOCK HAZARD

- * Do not disconnect or disassemble by non-professional personnel.
- * Do not drop, deform, impact, cut or spearing with a sharp object.
- * Do not place at a children or pet touchable area.
- * Do not place near open flame or flammable material.
- * Do not cover or wrap the product case.
- * Do not sit or put heavy things on battery.
- * Do not touch the leaking liquid.
- * Avoid of direct sunlight.
- * Avoid of moisture or liquid.
- * The product Ingress Protection (IP) class is IP20.
- * Make sure the grounding connection set correctly before operation.
- * Follow the product manual to make wiring connection.
- * If leaking, fire, wet or damaged, switch off the breaker on DC side and stay away from battery.
- * Contact your supplier within 24 hours if anything failure happens.

SAFE HANDLING GUIDE OF LITHIUM BATTERIES (Continued)

Tools:

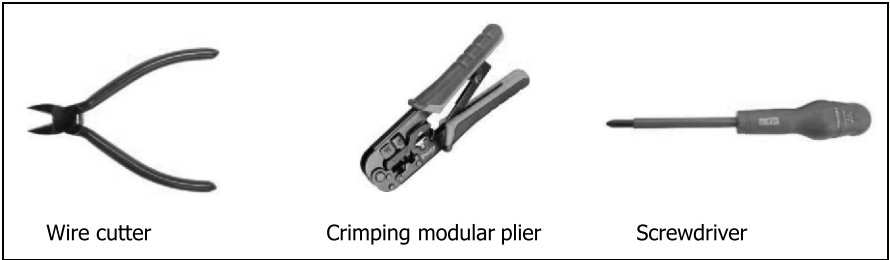

Note:

Use appropriately insulated tools to prevent accidental electric shock or short circuits. If insulated tools are unavailable, cover the entire exposed metal surfaces of the available tools, except their tips, with electrical tape.

Safety Gear:



It is recommended to wear safety gear, insulated gloves, safety Goggles and safety shoes when dealing with the battery pack.

Package Items

INSTRUCTIONS FOR USE

Package Items:

Unpack and check the packing list.

1. Battery Module Package;
 - a. Single Battery Pack;
 - 2 x Communication cable
 - 4 x Open Terminal
 - 1 x Installation Mounting Rack and Expansion Screws
 - 1 x Instruction Manual
 - b. can be customized per requirement:
Battery cable, communication cable, parallel cable.

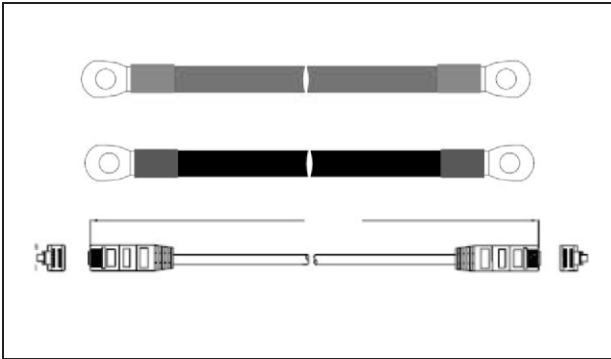

2. For Battery system connecting to inverters:
Two long power cables.
One communication cable for each energy storage system.

Installation Location

Make sure that the installation location meets the following conditions:

1. The area is completely waterproof.
2. The floor is flat and level.
3. There are no flammable or explosive materials.
4. The ambient temperature ranges 0°C to 45°C .
5. The temperature and humidity are maintained at a constant level.
6. There is minimal dust and dirt in the area.
7. The distance from the heat source is more than 2 meters
8. The distance from the air outlet of the inverter is more than 0.5 meters.
9. The installation area shall avoid direct sunlight.
10. The battery module has no mandatory ventilation requirement, but please avoid installation in confined areas. The operation shall avoid high salinity, humidity, or temperature.

INSTALLATION AND OPERATION (Continued)

CAUTION



If the ambient temperature outside is in the operating range, the battery pack will stop operating to protect itself. The optimal temperature range for the battery pack is 15°C to 35°C. Frequent exposure to harsh temperatures may deteriorate the performance and life of the battery pack.

Installation Of Mounting Rack

Install the battery mounting rack with following drawing dimension.

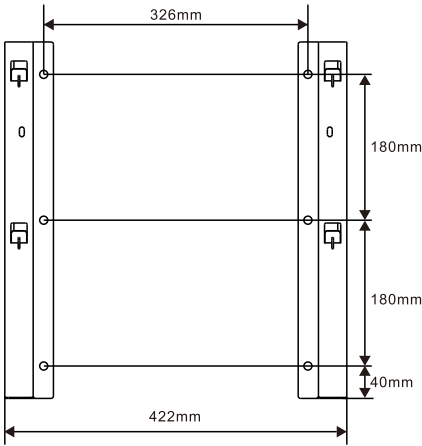

The dimensional drawing of universal rack for other models

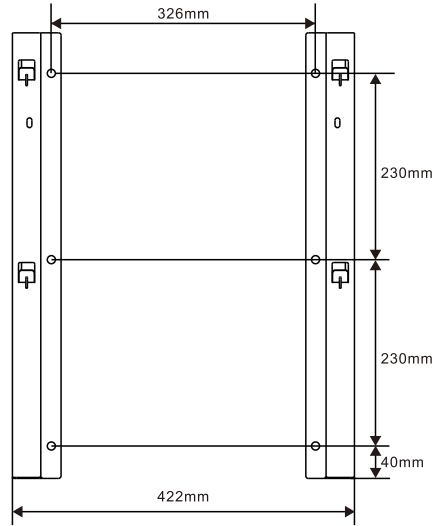

The dimensional drawing of dedicated rack for LP18PRO-48200

INSTALLATION AND OPERATION (Continued)

Installation of battery pack

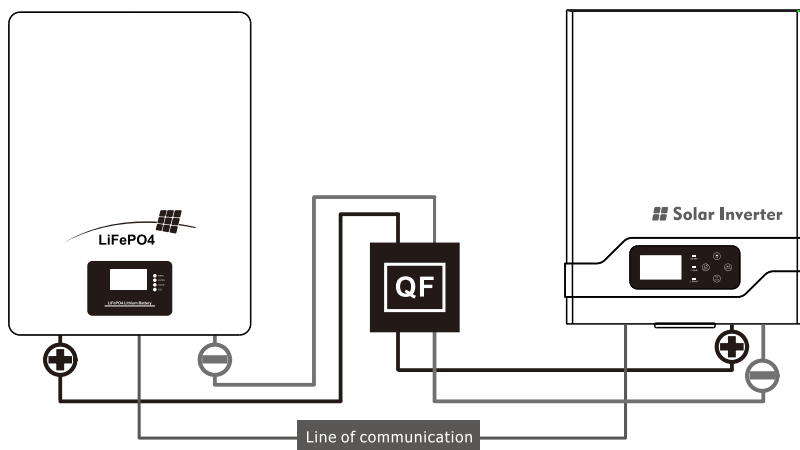

1. Connect the cables between battery modules.
2. Connect the cables to the inverter.

INSTALLATION AND OPERATION (Continued)

CAUTION



1. A suitable breaker between the battery system and inverter is required.
2. The complete installation and operation of the system must follow the local electric standard.

Power On:

Double check all the power and communication cables.

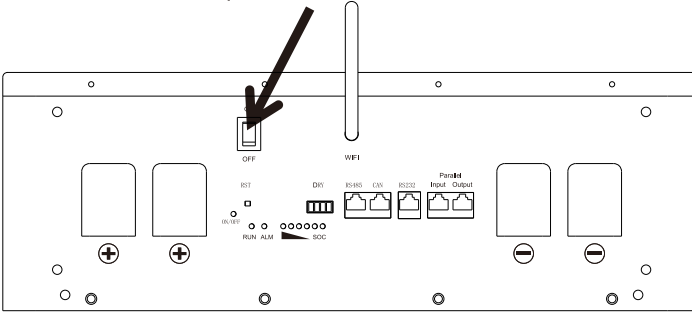

1. Switch on all the battery modules:
2. The one with an empty "Linkport 1" is the primary battery module; the others are secondary (1)primary Battery configuration with a maximum of 15 secondary batteries);

INSTALLATION AND OPERATION (Continued)

3. Switch the red switch on the primary battery to turn the power on; all the battery LEDs will be on one by one from the primary battery.

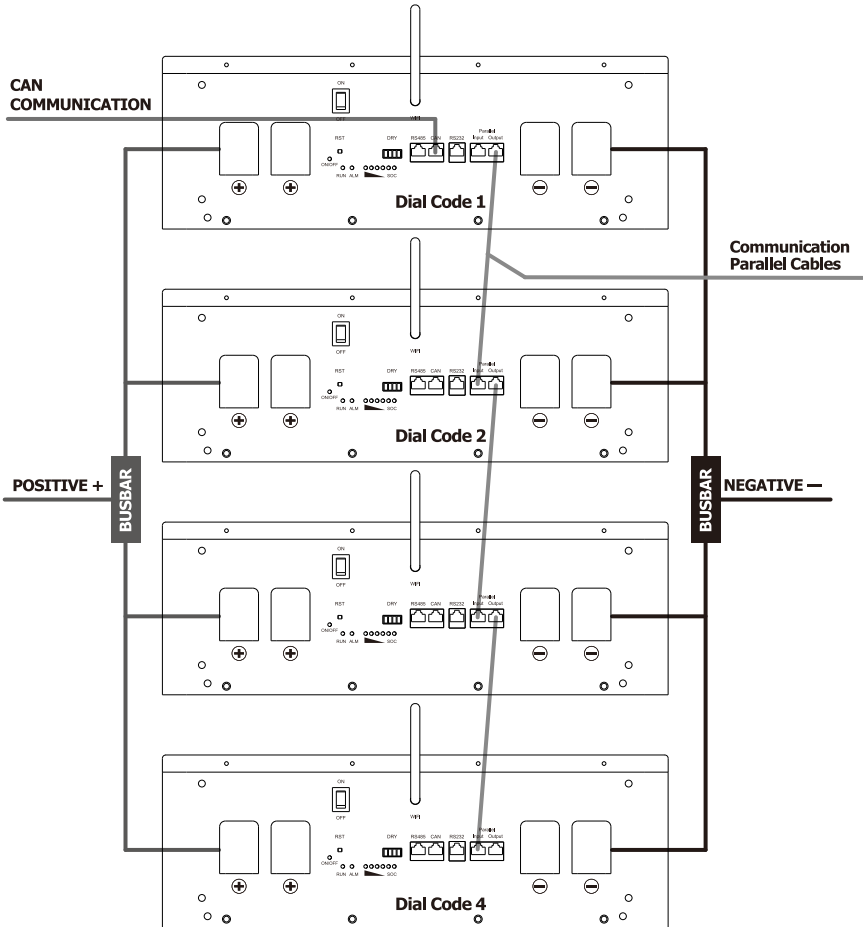

Note:

- After the battery module is powered on, activating the-soft start function takes 3 seconds. After the soft start, the battery is ready for high-power output.
- During capacity expansion or replacement,when different parallel soc/voltage of a module are together, please maintain the system idle for ≥ 15 mins or until the SOC LED lights up(=1 LEDS difference) before regular operation.

INSTALLATION AND OPERATION (Continued)

Power Off:

1. Turn the external power source off.
2. Switch the switch on the primary battery; all the batteries will turn off.
3. Turn off the power switch.

Multi-Group Mode :

Connect the power cable first:

1. Each pair of cables holds a max of 100A constant current. Connect enough pairs of cables based on the calculation of the system current.
2. A suitable protection breaker between the battery system and inverter is required.
3. Make sure all DIP switches of the primary batteries are ROxX, then turn the batteries on "R": is the baud rate of RS485 needed for all primary batteries to be the same.
4. After all the batteries are running, the primary battery's alarm in group twill sound 3 times. This indicates that all the groups are online.

EMERGENCY SITUATIONS

1. Leaking Batteries:

If the battery pack leaks electrolyte, avoid contact with the leaking liquid or gas. If one is exposed to the leaked substance, immediately perform the actions described below

- a. Inhalation: Evacuate the contaminated area and seek medical attention.
- b. Contact with eyes: Rinse eyes with flowing water for 15 minutes and seek medical attention.
- c. Contact with skin: Wash the affected area thoroughly with soap and water and seek medical attention.
- d. Ingestion: Induce vomiting and seek medical attention.

2. Wet Batteries:

If the battery pack is wet or submerged in water, keep people from accessing it, and then contact an authorised dealer for technical support. Cut off all power switches on the inverter.

3. Damaged Batteries:

Damaged batteries are dangerous and must be handled with the utmost care. They are not for use. And may pose a danger to people or property. If the battery pack seems damaged, pack it in its original container and return it to an authorised dealer.

CAUTION



Damaged batteries may leak electrolytes or produce flammable gases.

BATTERY MAINTENANCE

Maintenance while in use and storage:

- 1.charging the battery at least once every 6 months is required.For the maintenance charge, ensure the SOC is higher than 30%.
- 2.Every year after installation.The connection of power connectors, grounding points,power cables and screws are to be checked.Ensure there are no loose, broken, or corrosion at connection points Check the installation environment, such as dust, water,insects etc.
- 3.If the battery is stored for a long time, it is required to charge every six months,and the SOC should be higher than30%.

CLEANING INSTRUCTIONS - GENERAL

- Before cleaning: Ensure the product is not hot and has nothing connected to it before cleaning or maintaining it.
- Cleaning:wipe down the product's surface using a soft, dry cloth.
- Do not use harsh or abrasive cleaning chemicals or materials on the product ,as doing so may damage or scratch the finish.
- Do not expose the product to direct sunlight or high temperatures for extended period.
- Do not store in temperatures over 45°C.

ENVIRONMENTALLY FRIENDLY DISPOSAL

IMPORTANT INFORMATION FOR CORRECT DISPOSAL OF ELECTRICAL AND MECHANICAL COMPONENTS.

At the end of its working life, the product must not be disposed of as urban waste. It must be taken to a particular local authority differentiated waste collection centre or a dealer providing this service.Disposing a household appliance separately avoids possible negative environmental and health consequences from inappropriate disposal. It enables the constituent materials to be recovered to obtain significant savings in energy and resources.As a reminder of the need to dispose of household appliances separately, the product is marked with a crossed-out wheeled dustbin.

- Never dispose of used electrical and mechanical components with ordinary solid waste since they contain toxic substances.
- Always dispose of used electrical and mechanical components following the prevailing community regulations that apply to the disposal of electrical and mechanical components.