



QUICK INSTALL GUIDE



VILLA



The VILLA is an irrigation controller with a cover, featuring a mains-powered display. It offers flexible programming via Bluetooth, remotely (WiFi), or simply using the integrated buttons. This device can control up to 12 solenoid valves (24Vac) and is equipped with 2 inputs, each of which can accommodate either a rain sensor, a water meter, or a pressure sensor (pressure switch).

The VILLA, equipped with its cover, can be installed both outdoors and indoors. It offers the possibility to optimize your irrigation system through automatic Water budget linked to the weather forecast of its location, making it a connected and smart irrigation system. The VILLA comes with its protective cover, which will shield it from sunlight and rain. This cover will help secure your product with the option to add a padlock.

1 Installation

Before using the VILLA, please read the following safety instructions carefully and strictly follow the precautions. It can be installed both outdoors and indoors.

- 1.** Place your product in a location where the temperature is between -20°C and 40°C.
Consider the distance to your router's Wi-Fi to ensure an effective connection (maximum 10 meters).
- 2.** Once the product's location has been defined, secure your product using the 3 screws provided (two on the outer face and one on the inner) and connect your product to a power source using the supplied cable.
- 3.** Place the product so that the power plug is close to the material. The power plug acts as a disconnect device and must remain easily accessible in case of any issues. Ensure that the power plug is connected and equipped with protection against overcurrent and short circuits, such as a 16A circuit breaker.

2 Valve wiring

The VILLA has two locations for sensors [S1 + and S1 -] and [S2 - and S2 +]. You can connect three types of sensors: a **rain sensor**, a **pressure switch**, and a **water meter equipped with a pulse output** (dry contact type).

For offline usage, meaning for any individual wishing to operate the product solely through the screen and buttons, you can directly connect the rain sensor to the VILLA at input S1. The rain sensor will directly affect the VILLA and stop the watering schedule once the set rainfall level (adjusted on the sensor) is reached.

However, when you intend to connect and use the other two types of sensors (water meter or pressure switch), you must configure them using the application MySOLEM.

To ensure an efficient connection between your equipment and the VILLA, please strip the wires of your sensors and solenoid valves to 12 to 14mm before connecting them to the product.

Wiring example

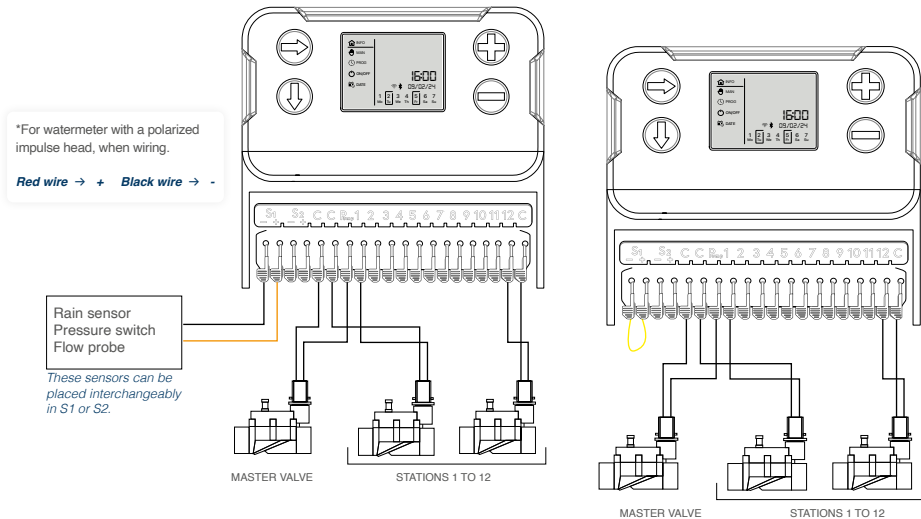

CONNECTING TO A SOLENOID VALVE

Follow these steps to easily wire your solenoid valves with our new system:

1. Lift the connector upwards.
2. Insert your cables.
3. Lower the connector downwards.

Reminder:

Upward connector = Open

Downward connector = Closed

When placing the black cables (with white marks) from your solenoid valves, make sure to connect the black cables (common) to the place marked as « C » on the VILLA. Several black cables from your solenoid valves will be connected to the same place on the VILLA.

Below is an example of wiring for your solenoid valves:

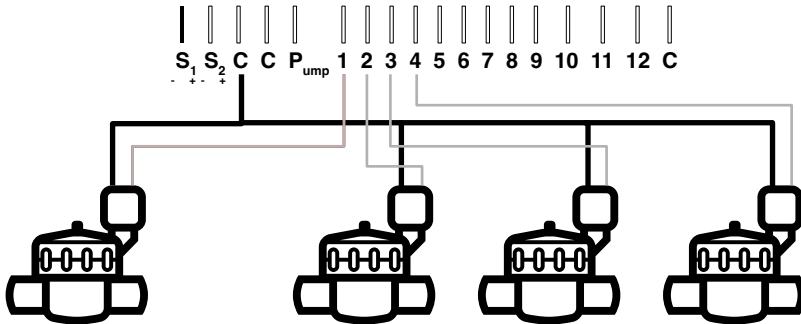

MODIFY THE POWER WIRING

If the supplied power cable is too short, you can modify the power wiring.

Before doing anything, please take all necessary measures to ensure your safety by turning off your product.

1. Open the product to access the wiring.
2. Unscrew the white plate leading to the power supply.
3. Lift the Wago connector and remove the power cable.
4. Connect your power supply respecting the wire colors (brown and blue).
5. Once the connectors are pressed down, you can screw the plate back on and power your product with 230 VAC.

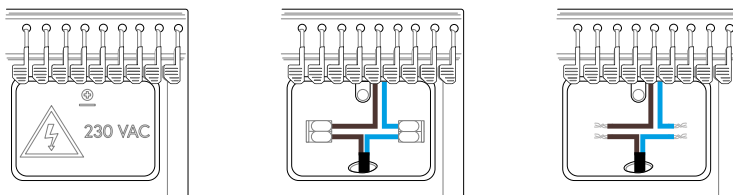

3 Online operation

Download the MySOLEM application from the **App Store** or **Google Play** on your smartphone and/or tablet.



ASSOCIATION

1. Connect the plug to the power source.
2. Launch the MySOLEM application from your smartphone and/or tablet.
3. Click on « **Add a controller** » or the « + » button.
4. Select the VILLA from the list of available controllers.
5. (Optional) Once selected, your VILLA can connect to a WiFi network (2.4 GHz). Select your network from the list.
6. Enter the password from your internet router (it is recommended to copy/paste the password to ensure accuracy).
7. Once connected to the network, the WiFi symbol should appear on the VILLA screen.

Notes:

- To benefit from all the features of the VILLA, it is recommended to create an account on MySOLEM.
- To complement this information, you can follow our explanatory videos on <https://support.mysolem.com/comment-associer-un-produit-solem-en-bluetooth/>
- Furthermore, if you want to connect your VILLA to a network, please follow the video tutorial on <https://support.mysolem.com/en/appairer-un-produit-solem-en-wi-fi/>

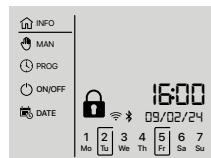

Once connected to the network, there are two ways to program and control the VILLA remotely.

- Through the **MySOLEM app**.
- Through the **online platform** [mysolem.com](https://support.mysolem.com).

This platform will allow you to enjoy numerous free features, such as creating customizable programs, automation based on your sensors, and even managing irrigation according to the weather in your location.

For more information on how to program/configure these functions, download the user manuals for the application/platform at <https://support.mysolem.com/manuels-utilisateurs/>

ADD AND SET UP A SENSOR

The VILLA has two locations for sensors [S1 + and S1 -] and [S2 - and S2 +]. You can connect three types of sensors: a **rain sensor**, a **pressure switch**, and a **flow meter**.

The **rain sensor** is preconfigured at input S1 and does not require installation through the application.

However, if you want to add the other two types of sensors, you will need to use the product's connected functionality.

1. Pair the product with Bluetooth.
2. Select « **Add a sensor** ».
3. Choose the type of sensor you wish to use (flow meter, rain sensor, pressure switch).
4. Select the parameters corresponding to your sensor.
5. Follow the wiring diagram indicated in the app.

Once these steps are completed, you can test all our features (alerts, threshold management, etc.).

For more information about our features, please refer to the user manuals on [mysolem.com](https://support.mysolem.com) or within the application <https://support.mysolem.com/manuels-utilisateurs/>

4 Offline operation *(Through the buttons)*

1. Remove the bottom cover of the VILLA.
2. Connect the integrated 230/24 Vac power supply to the product.
3. Put the cover back on.

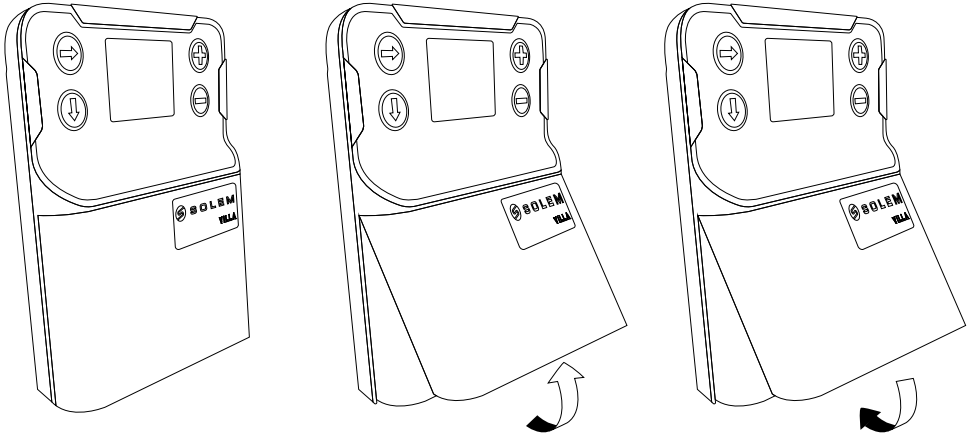

Lock/unlock the product through the keyboard

If you have set up a security code through the application, here's how to input it on the VILLA screen to unlock your product.

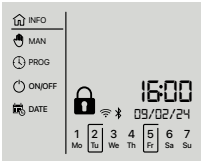
- 

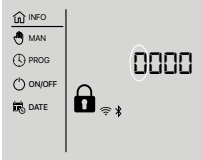
1 *Locked keyboard*
- 

2 *Press one of the buttons*

The first digit blinks

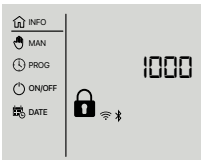
- 

3 *Press*

The first digit increases or decreases

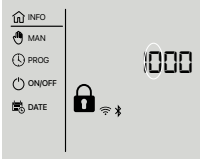
- 

4 *Press*

Pass onto the next digit

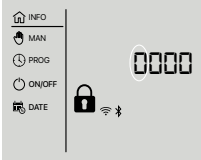
- 

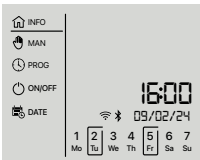
5 *Repeat the last two operations until the fourth digit.*
- 

6 *Keyboard unlocked*

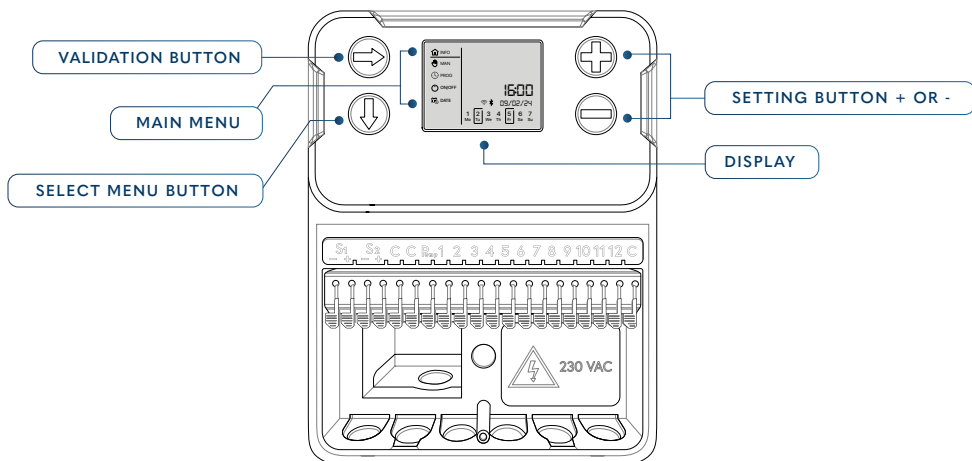

MAIN MENU

INFO

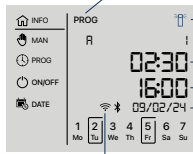

- Program in progress
- Operating station
- Remaining watering time
- Time
- Date
- WiFi connection

(If the WiFi symbol is flashing, it means the connection is in progress)

MAN



RUN OR STOP MANUAL COMMAND:

Manually turn on a station or a program (A,B,C...) and/or shutdown the watering in progress.

PROG

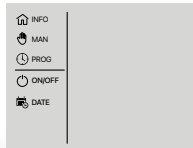

SET THE IRRIGATION PROGRAM:

Allows to set the custom programs that will be started automatically.

ON/OFF

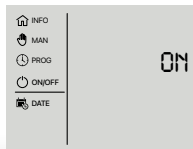

ON/OFF COMMAND:

Disables any current or future programs.



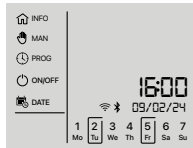













DATE

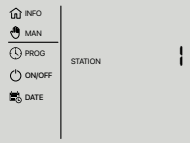

SET DATE & TIME :

Allows to set the date and time of the current day in 12 or 24 hour format.

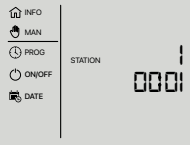
MANUAL COMMAND EXAMPLE

<p>Select</p>  <p>MAN</p> 		<p>Validate</p> 
<p>Select the Station mode</p> 		<p>Validate</p> 
<p>Set the Station mode</p>   		<p>Validate</p> 
<p>Set the duration</p>   <p>From 1 min to 12 hrs</p>		<p>Validate</p> 
<p>Watering begins</p>		<p>Remaining watering time</p>

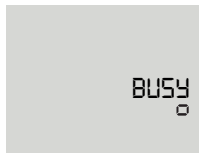

When you modify a new program and send its programming, you will see this screen.

FAULT ON LANE AND ACKNOWLEDGMENT

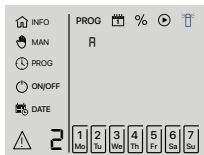

If one of your stations is not working (short circuit), the VILLA screen will display the station number (in this example, lane 2) in the bottom left box. When a lane malfunctions, the timer will directly move to the next station's program.



Once you have resolved your issue with the lane, you will need to acknowledge the repair.

To do this, you must access the VILLA menu via the pictogram menu. 



Validate 

Once validation is completed, your programs for lane 2 will resume. (This step is also possible via the application).

TECHNICAL CHARACTERISTICS

DIMENSIONS:

Width: 18 - 20.5 cm

Height: 23.7 - 24.1 cm

Depth: 8.3 - 8.9 cm

POWER SUPPLY UNIT:

INPUT : 230V ~ 50Hz

OUTPUT: 24Vac

Max. consumption.: 0,75 A (18 VA)

BANDWIDTH OF FREQUENCY USED AND MAXIMUM EMITTED POWER:

Bluetooth® : [2400-2483.5]Mhz

WiFi : 2.4Ghz

USAGE:

Protected against water jets: IP54

Operating ambient temperature of the product: -20°C to 40°C

Warranty: 3 years

EUROPE: DECLARATION OF CONFORMITY

Solem Electronique has declared that the VILLA irrigation controller complies with the essential requirements of the European directives:

Directives 2014/53/EU (RED):

Harmonized standards:

BLE standard: ETSI EN 300 328 v2.2.2

EMF standard: EN 62311 (2008) and recommendation 1999/519/CE

EMC standard: EN 61000-3-2 (2019) / EN 61000-3-3 (2013 + A1/2019)
& ETSI EN 301 489-1 v1.1.1 & EN 301 489-17 v3.1.1

Electrical Safety Standard: EN 62368-1 : 2014

RoHS directive 2011/65/EU & amendment of directive (EU) 2015/863

Clapiers, 23/11/2023

SOLEM ELECTRONIQUE

ZAE La Plaine

5, rue Georges Besse

34830 Clapiers,

FRANCE

Olivier Aussillous

Industrial Manager



FCC DECLARATION

Caution: the user that changes or modifications not expressly approved by the party responsible for compliance could void the user's authority to operate the equipment.

Note: This equipment has been tested and declared compliant with the limits for a Class B digital device, pursuant to part 15 of the FCC rules. These limits are designed to provide reasonable protection against harmful interference in a residential installation.

This equipment generates, uses and can radiate radio frequency energy and, if not installed and used in accordance with the instruction, may cause harmful interference is not guarantee that interference will not occur in a particular installation. If this equipment does cause harmful interference to radio or television reception which can be determined by turning the equipment off and on, the user is encouraged to try to correct interference by one or more of the following measures:

1. Reorient or relocate the receiving antenna.

2. Increase the separation between the equipment and receiver.
3. Connect the equipment into an outlet on circuit different from that to which the receiver is disconnected.
4. Consult the dealer or an experienced radio/TV technician for help.

This device complies with FCC RF radiation exposure limits set forth for general population. This device must be installed to provided a separation distance of a least 20cm from all persons and must not be colocated or operating in conjunction with any other antenna or transmitter.

IC STATEMENT

This class (B) digital apparatus complies with Canadian ICES-003.

Under Industry Canada regulations, this radio transmitter may only operate using an antenna of a type and maximum (or lesser) gain approved for the transmitter by Industry Canada. To reduce potential radio interference to other users, the antenna type and its gain should be so chosen that the equivalent isotropically radiated power (e.i.r.p.) is not more than that necessary for successful communication. This device complies with Industry Canada license-exempt RSS standards). Operation is subject to the following two conditions:

1. This device may not cause interference,
2. This device must accept any interference, including interference that may cause undesired operation of the device.

This device complies with Industry Canada RF radiation exposure limits set forth for general population. This device must be installed to provide a separation distance of a least 20cm from all persons and must not be co-located or operating in conjunction with any other antenna or transmitter.

