

# Н 100 (правий)

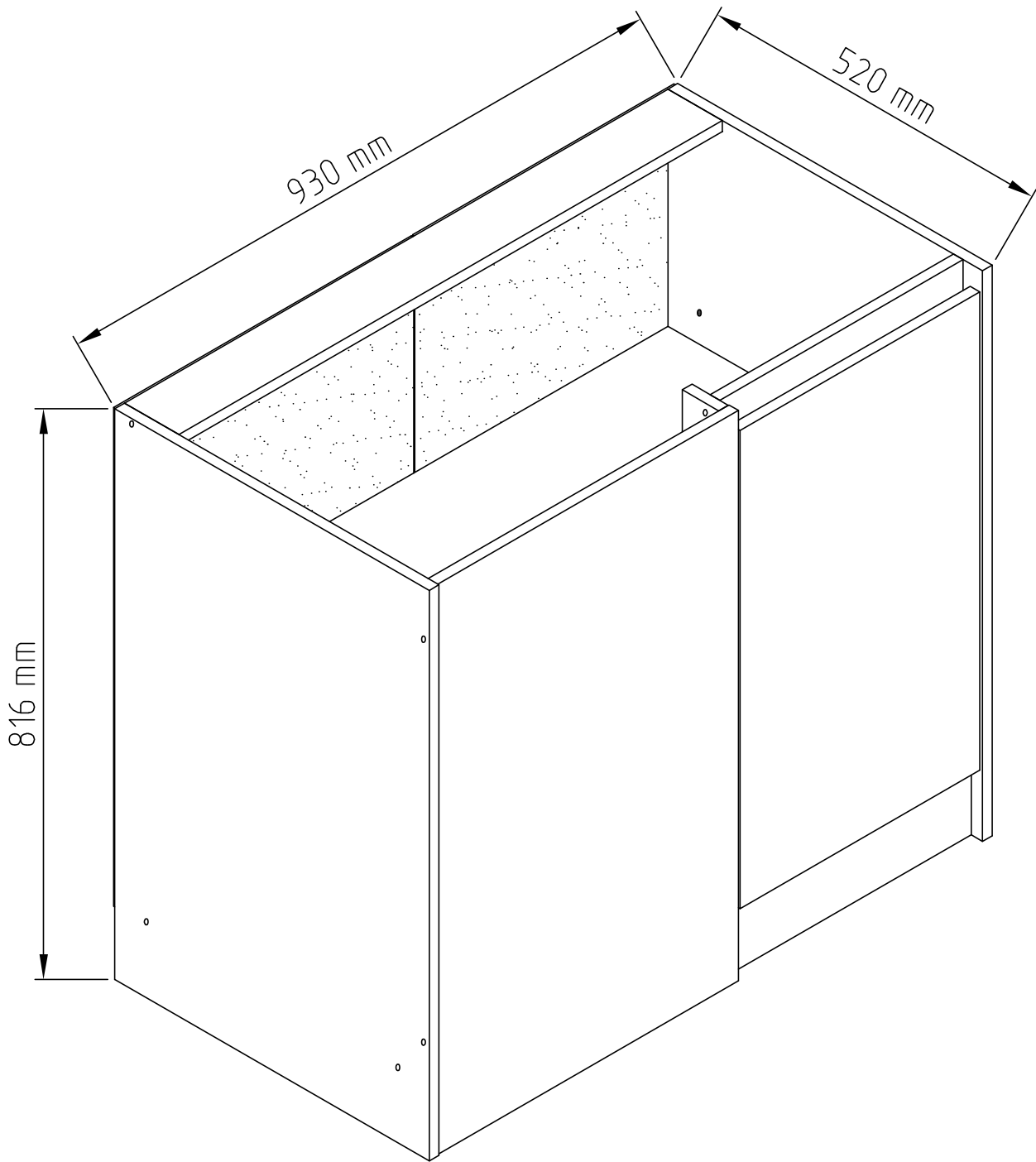







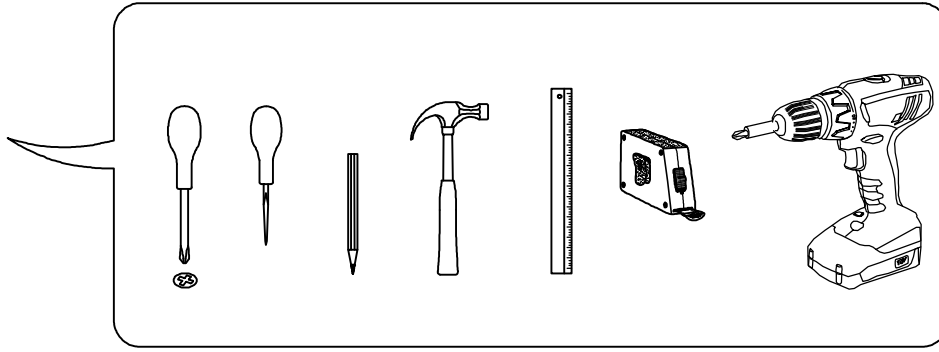
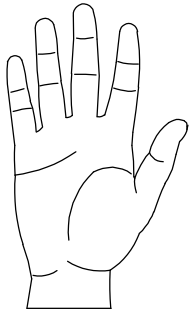

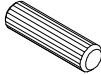

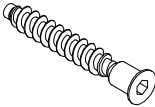
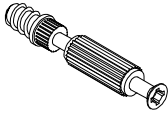

ГРАФІТІ (GRAFFITİ)

D 100 (R)

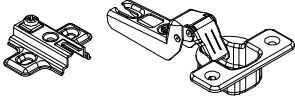
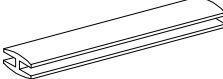

# Н 100 (правый)

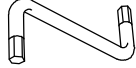

 <b>A1</b> 8*30mm x15	 <b>B</b> $\phi$ 12mm x11	 <b>B1</b> 6,3*50mm x11
 <b>C1</b> 6*43mm x2	 <b>D</b> $\phi$ 20mm x2	 <b>D1</b> 15/16 x2
 <b>E12</b> 4*16mm x4	 <b>E15</b> 4*30mm x8	 <b>F4</b> 6,3*13mm x4
 <b>J1</b> 5*16mm x4	 <b>K1</b> x5	 <b>L3</b> x2
 <b>O8</b> L-682 mm x1	 <b>R3</b> 1.4*25mm 0.020kg	 <b>R4</b> N°4 x1
 <b>U3</b> x1		

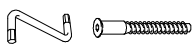
№	a*b	x	№	a*b	x
1L	816x520	x1	6	898x100	x1
1R	816x520	x1	7	700x60	x1
2	898x502	x1	8	816x497	x1
3	897x440	x1	9	684x396	x1
4	402x60	x1	10	712x462	x2
5	898x90	x1			x1

