

rollyFarm Trailer

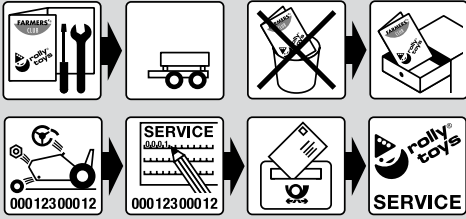
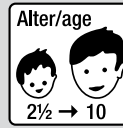

rolly toys Kundendienst Deutschland:

Tel: +49 (0) 95 68 / 856-142
 Fax: +49 (0) 95 68 / 856-183
 e-mail: service@rollytoys.de

2022/05

209.000.800.00

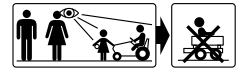
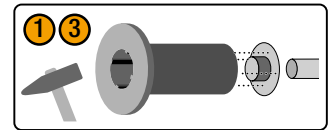
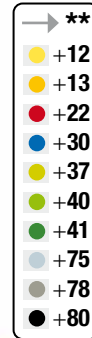
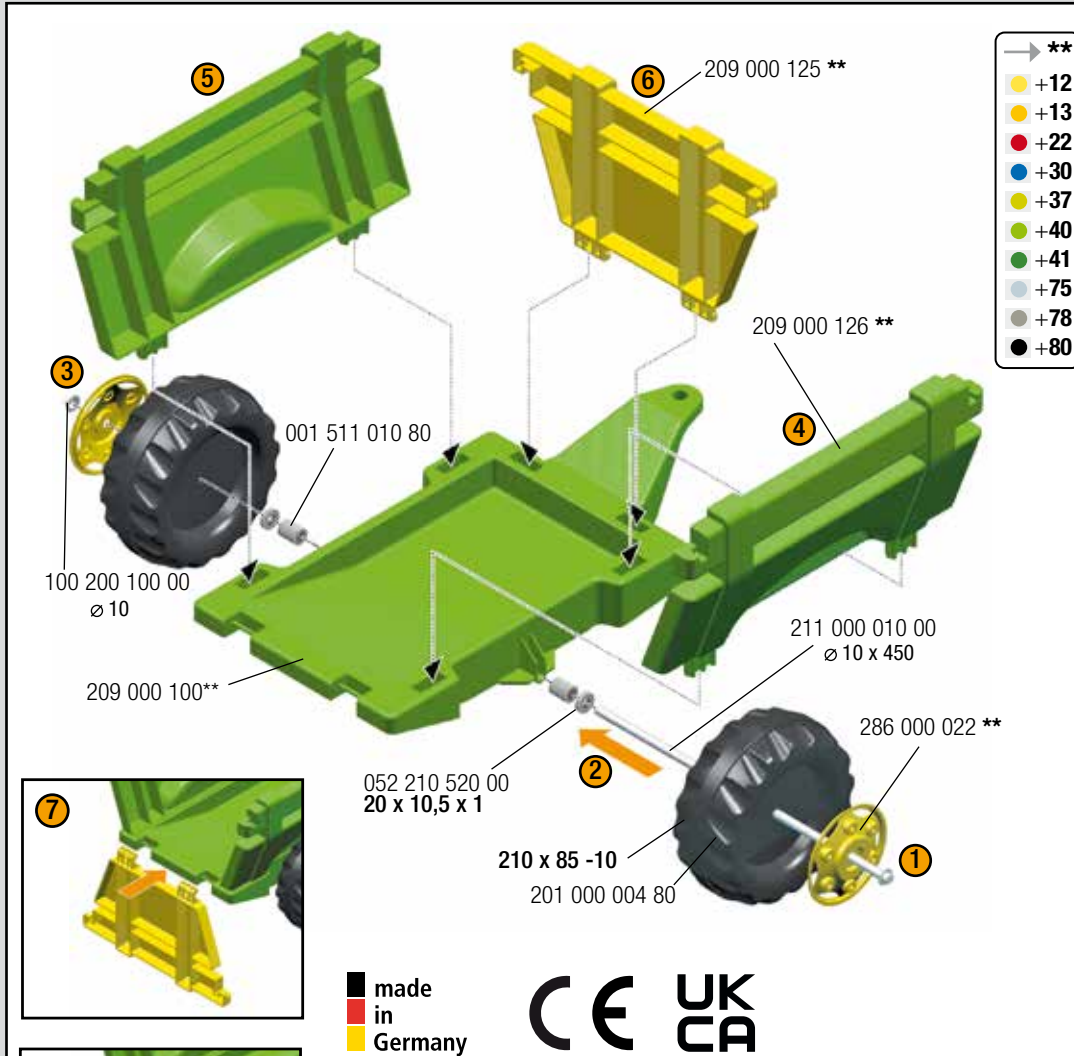

<input type="checkbox"/>	rolly Dreiradtraktoren	05 ...
<input type="checkbox"/>	rollyMinitrac	13 ...
<input checked="" type="checkbox"/>	rollyKiddy	62 ... / 63 ...
<input checked="" type="checkbox"/>	rollyKid	01 ... / 02 ...
<input checked="" type="checkbox"/>	rollyJunior	80 ... / 81 ...
<input checked="" type="checkbox"/>	rollyFarmtrac	60 ... / 61 ...
<input checked="" type="checkbox"/>	rollyFarmtrac Classic	03 ... / 04 ...
<input checked="" type="checkbox"/>	rollyFarmtrac Premium	70 ... / 71 ...
<input checked="" type="checkbox"/>	rollyX-Trac	03 ... / 04 ...
<input checked="" type="checkbox"/>	rollyTruck (Unimog)	03 ...

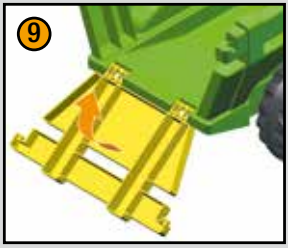
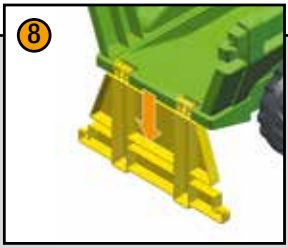
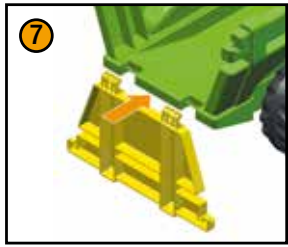

⚠️ AVERTISSEMENT

- RISQUE D'ÉTOUFFEMENT - Petites pièces. Risque d'ingestion. Contient des petites pièces à l'état non assemblé. Doit être assemblé par un adulte.
- Le jouet ne convient pas au transport des enfants.
- Si le jouet est défectueux, cessez de l'utiliser. Toute réparation ne doit être effectuée que par un adulte.
- Surveillance d'un adulte est requise.
- Ne jamais utiliser à proximité des marches, des pentes, des allées, des collines, des routes, des allées ou des piscines.
- Portez toujours des chaussures.
- Les autocollants ne doivent être appliqués que par des adultes.
- Conforme aux exigences de la norme internationale ASTM Standard Consumer Safety Specification on Toy Safety, F 963.

⚠️ WARNING

- CHOKING HAZARD - Small parts, Danger of being swallowed. Contains small parts in non assembled state. Must be assembled by adults.
- Toy is not suitable to carry children.
- If toy is defective stop using it, repairs may only be carried out by adults.
- Adult supervision required.
- Never use near steps, slopes, driveways, hills, roadways, alleys or swimming pool areas.
- Always wear shoes.
- The stickers are to be applied by adults only.
- Conforms to the requirements of ASTM Standard Consumer Safety Specification on Toy Safety, F 963.

---NORTH & SOUTH AMERICA only---
180 days warranty

From the date of purchase + guaranteed spare part service
 The warranty does not cover damages caused by improper use or neglect



Franz Schneider GmbH & Co KG
 Siemensstrasse 13-19
 D-96465 · Neustadt bei Coburg · Germany
 Tel.: +49 (0) 95 68 / 856-0
 Fax.: +49 (0) 95 68 / 856-190
 www.rollytoys.com