

DATA SHEET

Commercial Loudspeakers



MODEL OVO3T

3-INCH TWO-WAY LOUDSPEAKER



FEATURES

- Contemporary design, small, and budget-friendly
- Exceptionally wide coverage pattern
- Full-range, 2-way design ideal for background music and voice paging
- Included Pan-Tilt Mounting Bracket
- Included input wiring cover

TECHNICAL SPECIFICATIONS¹

Operating Mode	Passive with selectable low-impedance or 70 V/100 V operation, single amplified with DSP		
Operating Environment	Indoor		
Operating Range (-10 dB) ²	100 Hz to 20 kHz		
Nominal Beamwidth (H x V)	185° x 135°		
Transducers	LF 1 x 3" (76 mm) coated paper cone HF 1 x 1" (25 mm) silk dome driver		
Sensitivity ³		83 dB (2.83 V)	86 dB (1 W, 16 Ω)
Nominal Continuous Power Handling ⁴	18 V (20 W, 16 Ω Nominal Impedance)		
Nominal Maximum SPL ⁵ (Processed)	@ 1 m	Continuous 93 dB	Peak 99 dB
Rated Continuous Voltage ⁶	17.8 V (25 dBV)		
Rated Maximum SPL ⁷ (Processed)	@ 1 m	Continuous 93 dB	Peak 105 dB
Transformer	70 V: 6 W, 3 W, 1.5 W, 0.75 W; 100 V: 6 W, 3 W, 1.5 W		
Required Accessories	90 Hz, 12 dB / oct. Butterworth high pass filter; DSP preset		
Recommended Amplifiers	20 W - 40 W, into 16 Ω (18 V - 25 V)		

APPLICATIONS

DISTRIBUTED

Bars and Restaurants · Hotels · Casinos
Shopping Malls · Retail Spaces · Corridors
Building Lobbies · Health and Fitness Clubs
Airports · Transportation Hubs

DESCRIPTION

OVO3T is design two-way 70V/100V or low impedance surface mount loudspeaker that can be used for background music and paging purposes in a wide variety of applications. An easily accessible switch on the rear of the enclosure allows selection of 16 ohm or 70V/100V operation.

The OVO3T is an ideal speaker for large projects like company buildings, neighborhood centers, commercial applications, shopping centers and hotels. Thanks to the contemporary design this speaker fits into any space, whatever its décor or interior style. Additionally, its tiny size allows OVO3T to virtually disappear into the background in any mounting location.

The rugged ABS enclosure guarantees years of trouble-free operation and is paintable to match any interior. The 3" paper cone woofer and 1" silk dome tweeter provide an exceptionally wide dispersion, making it ideal to cover long, linear spaces while maintaining project budgets.

OVO3T can be mounted with the included pan-tilt bracket. The spring-lever wiring terminals ensure quick and easy mounting in a wide range of orientations, and the included input cover ensures a clean, finished look once installed. The OVO3T speakers can be painted any color to match the room's decor.

PHYSICAL

Input Connection	Spring-lever terminals with wiring cover		
Controls	Wattage / low impedance selector switch		
Mounting Provisions	Pan-tilt bracket <u>and</u> rubber tabletop stand		
Compliance	IEC 62368-1 certified		
Environmental Rating	IP40 per IEC 60529		
Dimensions H x W x D	160 mm x 108 mm x 119 mm [6.31" x 4.24" x 4.67"]		
Weight (loudspeaker/mount)	1.08 kg [2.4 lbs]		
Finish	Refer to the Technical Drawings (page 3)		
Models (Order by color)	OVO3T [-BL,-W]		
Included Accessory	Pan-tilt bracket (attached) Small color-matched stand - for desk or shelf placement		

Biamp strives to improve its products on a continual basis. Specifications are therefore subject to change without notice.



Commercial Loudspeakers

MODEL OVO3T 3-INCH TWO-WAY LOUDSPEAKER

AXIAL PROCESSED SENSITIVITY (dB SPL)⁸

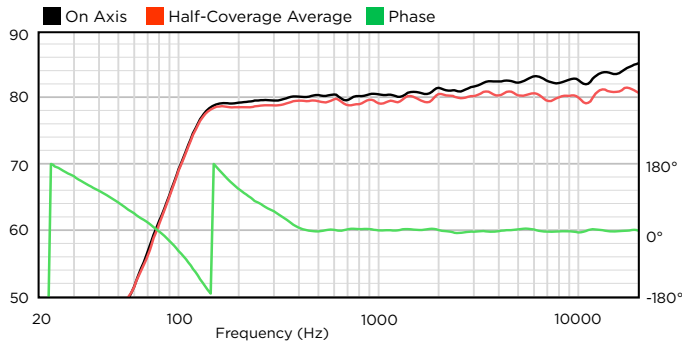

HORIZONTAL OFF-AXIS RESPONSE (dB)⁹

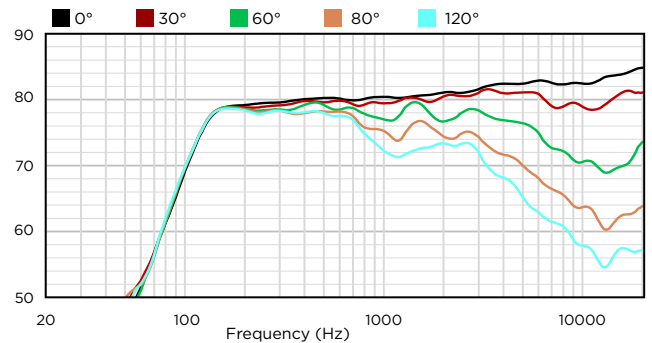

AXIAL SENSITIVITY (dB SPL)⁸

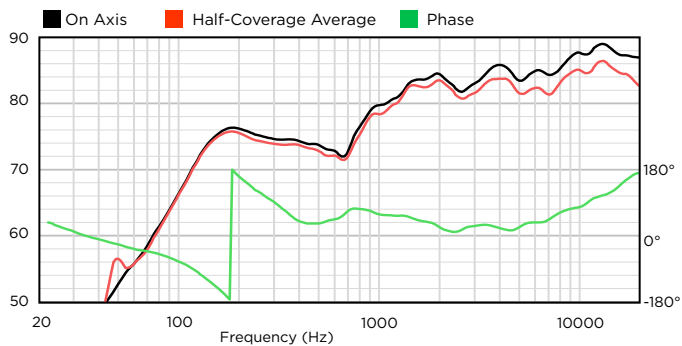

VERTICAL OFF-AXIS UP RESPONSE (dB)⁹

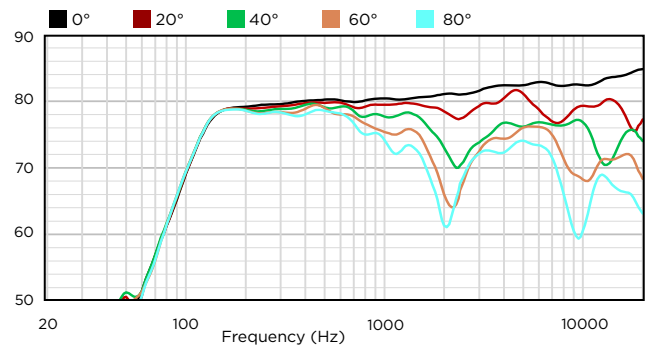

IMPEDANCE (Ω)

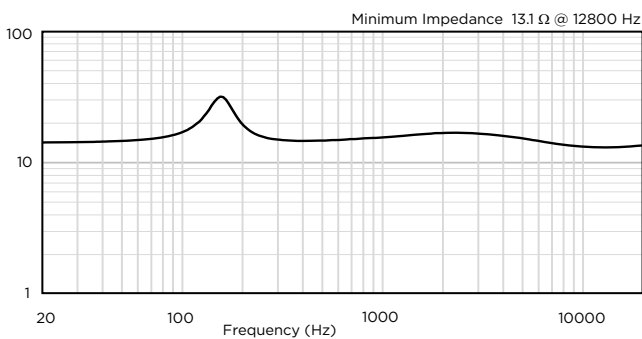

VERTICAL OFF-AXIS DOWN RESPONSE (dB)⁹

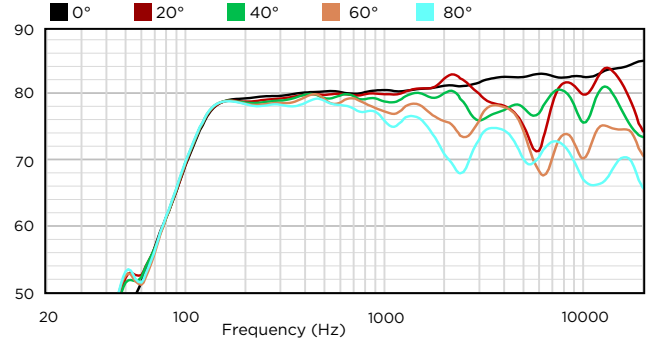

DIRECTIVITY INDEX (dB)¹⁰

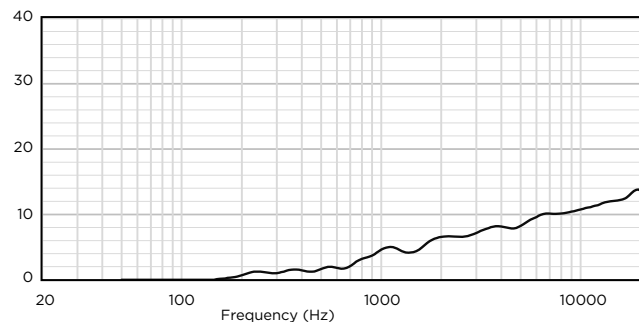

BEAMWIDTH (degrees)¹¹

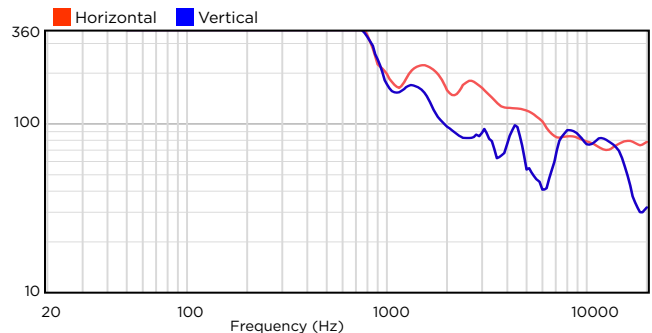

Commercial Loudspeakers

MODEL OVO3T

3-INCH TWO-WAY
LOUDSPEAKER

TECHNICAL DRAWING / DIMENSIONS / FINISH

H x W x D (without P/T bracket)
160 mm x 108 mm x 119 mm
[6.31" x 4.24" x 4.67"]

Unit Weight

1.08 kg [2.4 lbs]

Shipping Weight

3.2 kg [7.05 lbs] shipped in pairs

Grille:

Painted perforated steel backed with color-matched woven fabric. Black (RAL 9011) or White (RAL 9003) finish, paintable

Enclosure / Finish

ABS plastic, Black (RAL 9011) or White (RAL 9003) finish, paintable

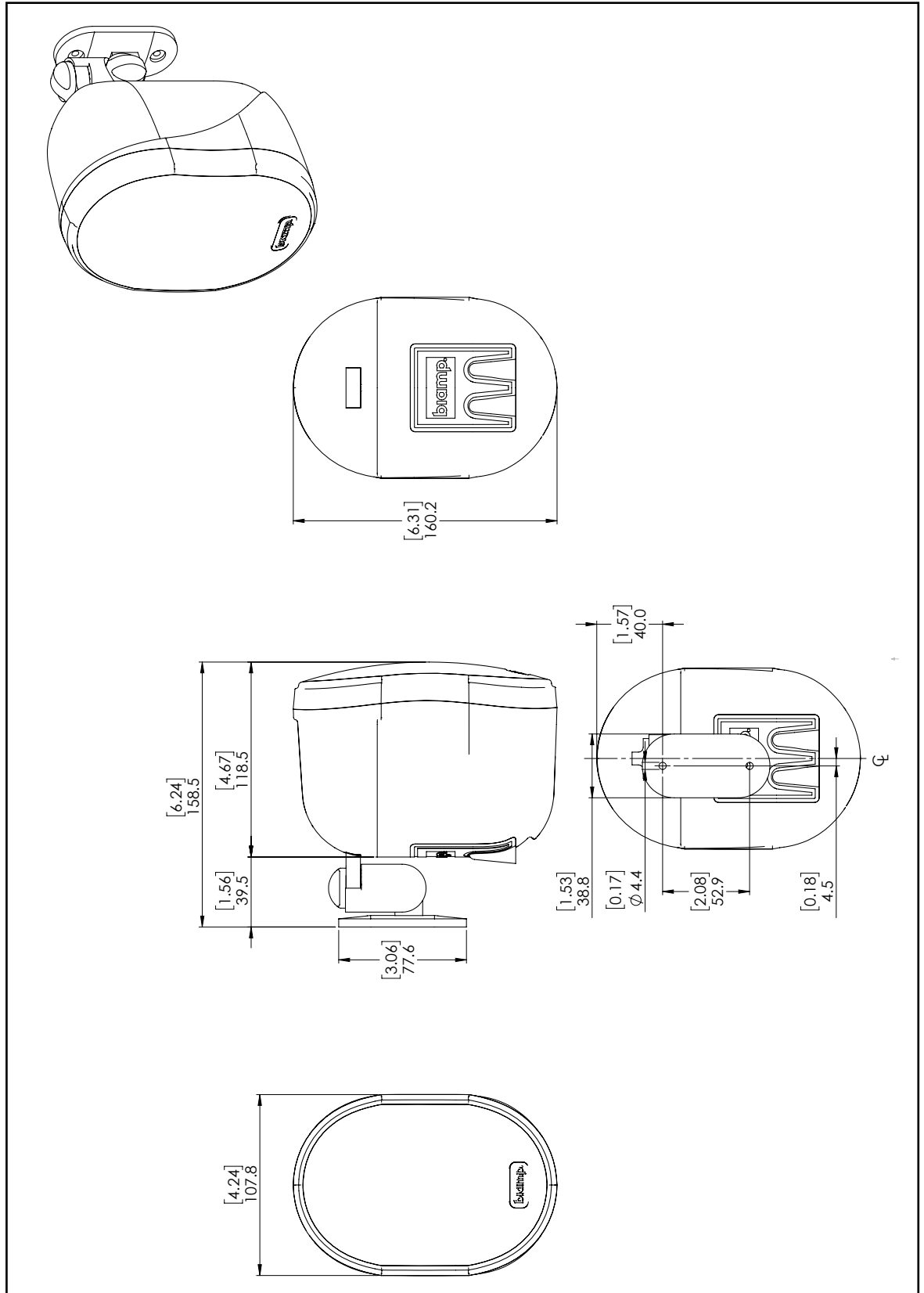

Commercial Loudspeakers

MODEL OVO3T 3-INCH TWO-WAY LOUDSPEAKER

CONNECTION DIAGRAMS

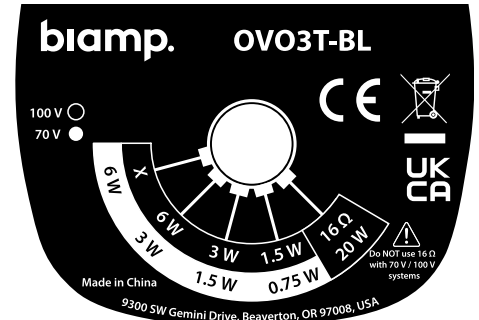
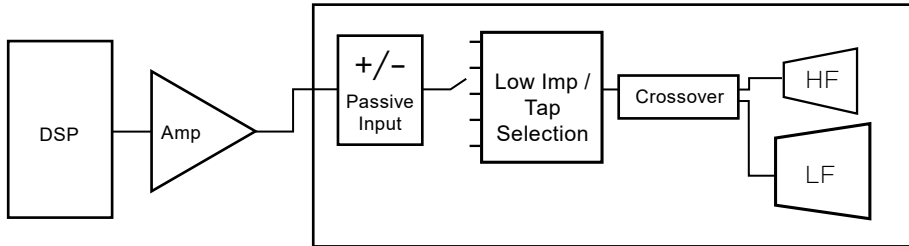

Input panel

NOTES

- PERFORMANCE SPECIFICATIONS** All measurements are performed using a time-windowed impulse response to eliminate reflections, approximating an anechoic environment, at a distance of at least 6 m. All acoustic specifications are rounded to the nearest whole number. An external DSP using settings provided by Biamp is required to achieve the specified performance; further performance gains can be realized using the FIR loudspeaker optimization presets available in Biamp's Community Amplified Loudspeaker Controllers (ALCs).
- OPERATING RANGE** The frequency range over which the on-axis equalized/processed response remains within 10 dB of the rated sensitivity, in accordance with IEC 60268-5.
- SENSITIVITY** The broadband SPL of the loudspeaker when pink noise is applied (band limited to the loudspeaker's Operating Range) at an input voltage of 2.83 V, in accordance with IEC 60268-5. Also listed for a voltage that would produce 1 watt into the rated impedance. Measured in whole space with no external processing applied, except where indicated.
- NOMINAL CONTINUOUS POWER HANDLING** The maximum continuous nominal input voltage at the rated impedance that the system can withstand, without damage, for a period of 2 hours using an IEC 60268-1 defined spectrum with recommended signal processing and protection filters.
- NOMINAL MAXIMUM SPL** The SPL produced when an IEC 60268-1 signal is applied, at the maximum continuous nominal input voltage, to the equalized/processed loudspeaker system. Referenced to a distance of 1 meter. The peak SPL represents the 2:1 (6 dB) crest factor of the IEC 60268-1 test signal.
- RATED CONTINUOUS VOLTAGE** The maximum continuous rated input voltage for the system that results in no more than a 3 dB change in the system's response during operation using an IEC 60268-1 defined spectrum with recommended signal processing and protection filters.
- RATED MAXIMUM SPL** The SPL produced when a typical program material signal is applied to the equalized/processed loudspeaker system, at a level which drives at least one subsection to its rated continuous voltage limit. Referenced to a distance of 1 meter. The peak SPL represents the 4:1 (12 dB) crest factor of the program signal.
- AXIAL PROCESSED SENSITIVITY** The variation in acoustic output level with frequency for a swept-sine measurement signal. The Processed measurement uses the recommended signal processing for the loudspeaker system. The other sensitivity measurements use no additional external processing. All data are referenced to 1 meter. The on-axis magnitude and phase responses, as well as the average magnitude response, calculated over one-half of the nominal coverage angles, are shown. The responses have 1/6 octave smoothing applied.
- HORIZONTAL / VERTICAL OFF-AXIS RESPONSES** The loudspeaker's magnitude response at various off-axis angles using the recommended signal processing in the operating mode which utilizes the largest number of individually amplified pass bands. The responses have 1/3 octave smoothing applied.
- DIRECTIVITY INDEX** The ratio of the on-axis SPL to the mean SPL at the same distance for all points within the measurement sphere for each given frequency; expressed in dB. The response has 1/3 octave smoothing applied.
- BEAMWIDTH** The included angle between the -6 dB points in the polar response of the loudspeaker when driven in the operating mode which utilizes the largest number of individually amplified pass bands. The responses have 1/3 octave smoothing applied.

CAUTION: Installation of loudspeakers should only be performed by trained and qualified personnel. It is strongly recommended that a licensed and certified professional structural engineer approve the mounting design.