

# SOLAX X3-IES

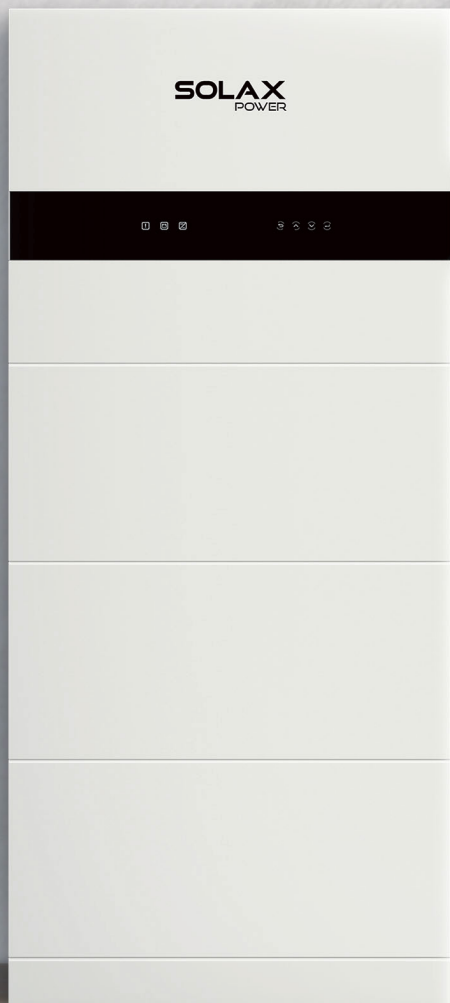

**X3-IES**

5kW/6kW/8kW/10kW/12kW/15kW





# INTRODUCTION

This is an integrated residential ESS which comes with a 5-15kW hybrid Three-phase inverter and extensible battery modules, plug and play, capacity range from 10 to 30 kWh. It has excellent performance in economy, safety and robustness. In addition, intelligent functions like VPP, micro-grid, smart schedule and smart scene are all ready. It would be the best choice for householders.

## SolaX IES

### ◀ Features

#### Economic

- All in one design, plug and play, expandable and installation easily
- Maximum 200% oversize and 200% PV input power
- Maximum 20A DC single string input current, support high power solar panel
- Low start output voltage makes inverter longer working time
- Built-in shadow tracking function

#### Safe

- IP66 protection level
- AC&DC SPD type II, always guarding the inverter
- AFCI optional

#### Robust

- Robust back-up ability, switchover time < 10ms(UPS level) , up to 200% EPS output for 10s, support half-wave loads
- Battery heating technology, -30°C extreme environment operation

#### Intelligent

- AI ready, forecasting solar generation and home consumption, smart energy management strategy
- VPP ready, SolaX cloud support resource aggregator(IEEE 2030.5, OpenADR)
- Micro-grid ready, supporting a variety of scenarios, both on-grid and off-grid, balancing power between PCS and Hybrid in real time.
- Support smart scene function, intelligent loads management(e.g., Heat pump, EV charger)
- Support 7×24h scheduling mode
- Support Wireless meter solution





## SYSTEM OVERVIEW

System schematic



Rated output power [kW]	5 / 6 / 8 / 10 / 12 / 15				
Number of batteries	2	3	4	5	6
Nominal capacity [kWh] <sup>①</sup>	10.2	15.3	20.4	25.6	30.7
Usable energy [kWh] <sup>②</sup>	9.2	13.8	18.4	23.0	27.6
Max. charge / discharge power [kW] <sup>③</sup>	10.2	15	15	15	15
Degree of protection	IP66				
Operating temperature range [°C]	-30 to 53				
Allowable relative humidity range [%]	5-95 (No condensation)				
Max. operating altitude [m]	3000				
Net weight [kg] <sup>④</sup>	144.2	191.2	144.2 / 100.5	144.2 / 147.5	191.2 / 147.5
Dimension (W x H x D) [mm]	730 x 1281 x 209.5	730 x 1599 x 209.5	730 x 1281 x 209.5/ 730 x 809 x 150	730 x 1281 x 209.5/ 730 x 1127 x 150	730 x 1599 x 209.5/ 730 x 1127 x 150
Display	LCD				
Cooling concept	Natural cooling				
Topology	Transformerless				
Communication	RS485, Pocket-X, USB, CAN, DO, DI				

① Test conditions: 25°C, 100% depth of discharge (DoD), 0.2C charge & discharge.

② System usable energy may vary with inverter different setting.

③ The max.charge/discharge power must not exceed the rated output power (the table takes the maximum power inverter as an example).

④ Different inverter models have different weights. The heaviest one is taken as an example.

## SPECIFICATIONS

**X3-IES-5K**    **X3-IES-6K**    **X3-IES-8K**    **X3-IES-10K**    **X3-IES-12K**    **X3-IES-15K**

### INPUT PV

Max. recommended PV array power [Wp]	10000	12000	16000	20000	24000	30000
Max. DC voltage [V]	1000					
Nominal DC operating voltage [V]	600					
Max. input current (input PV1 / input PV2) [A]	PV1: 20 / PV2: 20	PV1: 20 / PV2: 20	PV1: 32 / PV2: 20	PV1: 32 / PV2: 20	PV1: 32 / PV2: 20	PV1: 32 / PV2: 20
Max. short circuit current (input PV1 / input PV2) [A]	PV1: 25 / PV2: 25	PV1: 25 / PV2: 25	PV1: 40 / PV2: 25	PV1: 40 / PV2: 25	PV1: 40 / PV2: 25	PV1: 40 / PV2: 25
MPPT voltage range <sup>①</sup> [V]	110 to 950					
Start output voltage [V]	140					
No. of MPP trackers / Strings per MPP tracker	2 / (1 / 1)	2 / (1 / 1)	2 / (2 / 1)	2 / (2 / 1)	2 / (2 / 1)	2 / (2 / 1)

### INPUT AC

Normal AC power [VA]	10000	12000	16000	20000	20000	20000
Max. AC current [A]	16.1	19.3	25.8	32.0	32.0	32.0
Rated grid Frequency [Hz]	50 / 60					
Power factor	~1 (Adjustable from 0.8 leading to 0.8 lagging)					

### OUTPUT AC(On-Grid)

Nominal AC power [VA]	5000	6000	8000	10000 (AS4777 9999)	12000	15000
Max. apparent AC power [VA]	5500	6600	8800	10000 (AS4777 9999)	13200	16500
Rated grid voltage(AC voltage range) [V]	3P4W, 380 / 400					
Rated grid Frequency [Hz]	50 / 60					
Rated AC Output Current [A] ( at 230V, 50Hz)	7.3	8.7	11.6	14.5	17.4	21.8
Max. AC current [A]	8	9.6	12.8	14.5	19.2	24.0
Displacement power factor	~1 (Adjustable from 0.8 leading to 0.8 lagging)					
Total harmonic distortion (THDi, rated power) [%]	< 3					

**X3-IES-5K      X3-IES-6K      X3-IES-8K      X3-IES-10K      X3-IES-12K      X3-IES-15K**

<b>EPS OUTPUT(With Battery)</b>						
EPS peak power [VA]	2Pn, 10s (Full sun)	2Pn, 10s (Full sun)	2Pn, 10s (Full sun)	2Pn, 10s (Full sun)	2Pn, 10s (Full sun)	2Pn, 10s (Full sun)
EPS rated power [VA]	5000	6000	8000	10000	12000	15000
EPS rated voltage [V], Frequency [Hz]	3P4W, 380 / 400, 50/60					
EPS rated current [A]	7.3	8.7	11.6	14.5	17.4	21.8
Switchover time [ms]	< 10					
Total harmonic distortion (THDv, linear Load) [%]	< 3					
Max. half wave loads [kW]	2					
<b>BATTERY</b>						
Battery voltage range [V]	160 ~ 800					
Communication interfaces	CAN / RS485					
BMS module	TBMS-MCS0800E					
Battery module	TP-HS50E					
Composition	TBMS-MCS0800E + TP-HS50E * n + Base Dimensions + Series Box (Required for two columns)					
Battery type	Li-ion (LFP)					
Nominal capacity [kWh] / Nominal capacity [Ah] <sup>②</sup>	5.1 / 50					
Usable energy [kWh] <sup>③</sup>	4.6					
Standard power [kW]	3					
Max power [kW]	5.1					
Max. charge / discharge current [A] <sup>④</sup>	50					
Cycle life [Cycles]	> 6000					
Warranty [Years]	10					
Safety	CE, RCM, TUV (IEC62619), RoHS, REACH					
TBMS-MCS0800E dimensions(W x H x D) [mm] / Weight [kg]	730 x 165 x 150 / 9.3					
TP-HS50E dimensions(W x H x D) [mm] / Weight [kg]	730 x 318 x 150 / 47					
Base dimensions(W x H x D) [mm] / Weight [kg]	730 x 75 x 150 / 3.9					
Series box dimensions(W x H x D) [mm] / Weight [kg]	167 x 91.5 x 121 / 1.3					
<b>EFFICIENCY</b>						
Max. efficiency [%] / Euro-efficiency [%]	98/ 97.7					
Rated battery charge [%] / Discharge efficiency [%]	98.5 / 97					
<b>GENERAL DATA (Inverter)</b>						
Dimensions (W x H x D) [mm]	717 x 405 x 209.5					
Weight [kg]	< 37					
Operating temperature range [°C]	- 35 to 60 (derating at +45)					
Relative humidity [%]	0 to 100 (condensing)					
Storage temperature [°C]	- 40 to 65					
Noise emission (typical) [dB(A)]	< 33					
Internal consumption (night) [W]	< 40 for hot standby, < 5 for cold standby					
Idle mode	Yes					
<b>PROTECTION</b>						
Anti-Islanding protection	Yes					
DC reverse polarity protection	Yes					
Insulation monitoring	Yes					
Residual current monitoring	Yes					
AC overcurrent protection	Yes					
AC short-circuit protection	Yes					
AC overvoltage protection	Yes					
Over-heat protection	Yes					
AFCI	OPT					
Surge protection	Type II, DC and AC					
<b>STANDARD</b>						
Safety	IEC62109-1 / IEC62109-2					
EMC	EN 61000-6-1 / EN 61000-6-2 / EN 61000-6-3					
Certification	VDE 0126-1-1 A1:2012 / VDE-AR-N 4105 /G98/G99/ AS4777 / EN50549/ CEI 0-21					

① Any DC input voltage beyond the MPPT voltage range may result in inverter improper operating.

② Test conditions: 25°C, 100% depth of discharge (DoD), 0.2C charge & discharge.

③ System usable energy may vary with inverter different setting.

④ Discharge: In case of battery cell's temperature range of -20°C~10°C and 45°C~53°C, the discharge current will be reduced; Charge: In case of battery cell's temperature range of 0°C~25°C and 45°C~53°C, the charge current will be reduced. Product charge or discharge power depends on the actual temperature of battery pack.

# TACTICAL SCENARIO

## PARTIAL SOLUTION

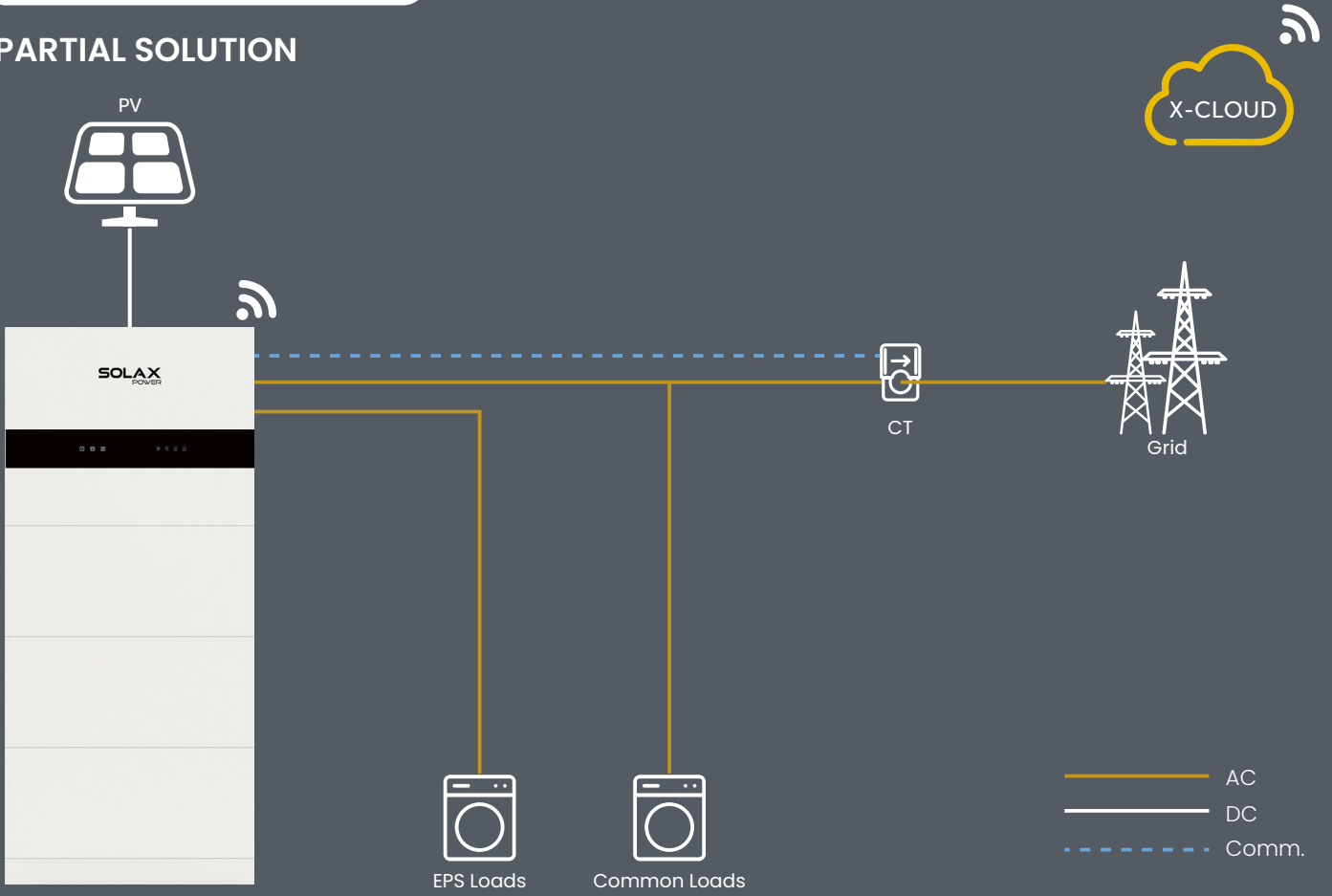

## WHOLE HOME BACKUP SOLUTION

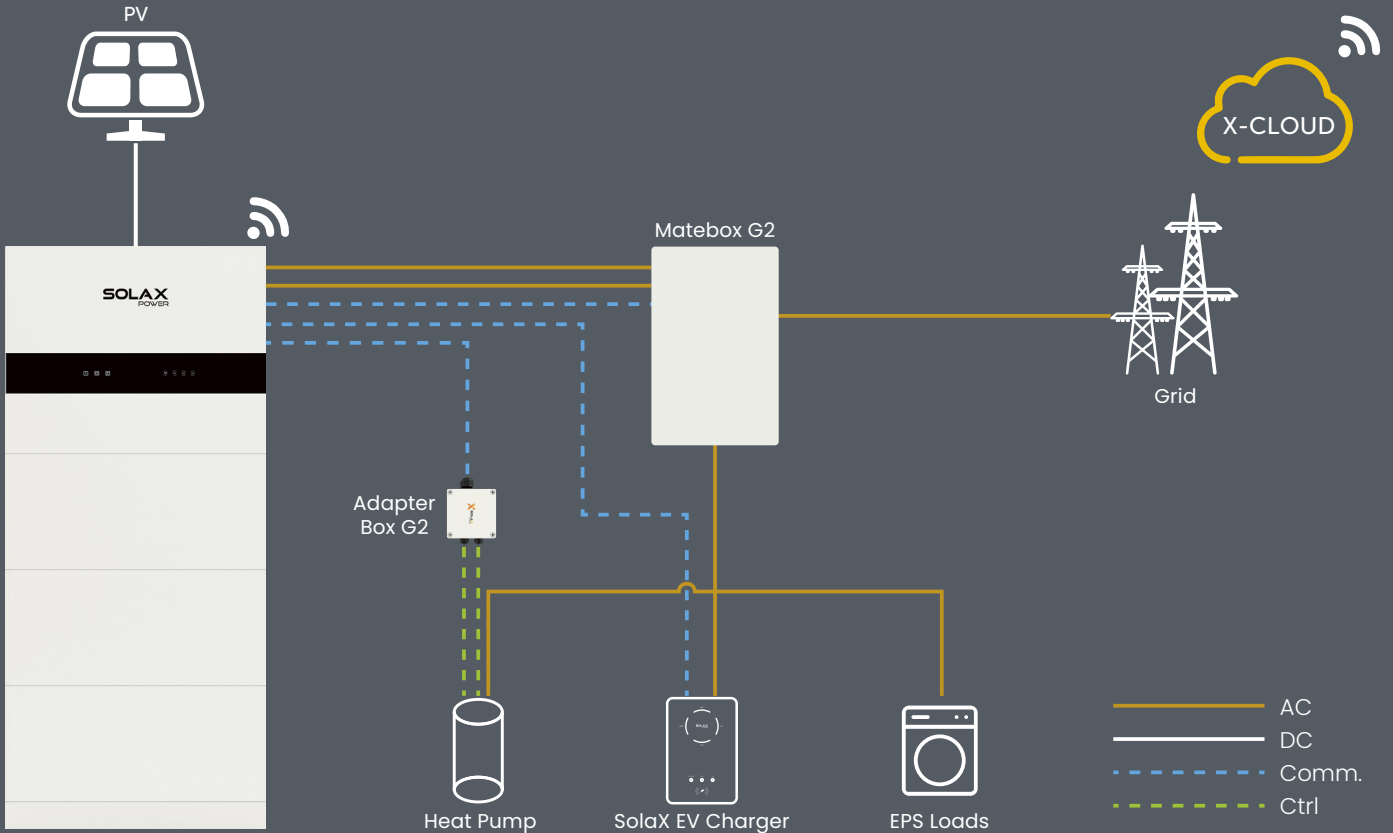

# 0 INJECTION SOLUTION

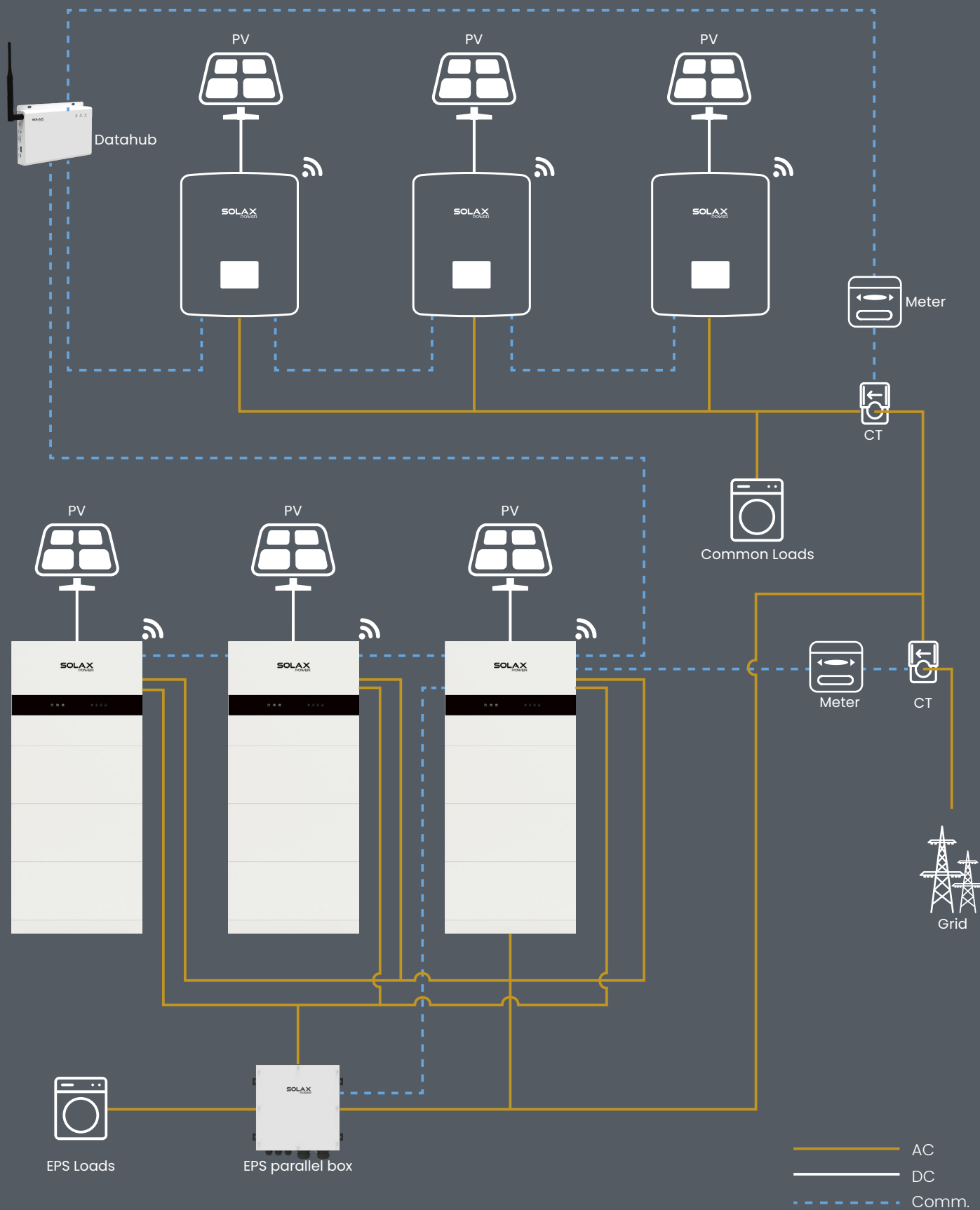

# PARALLEL & GENERATOR INTEGRATED SOLUTION

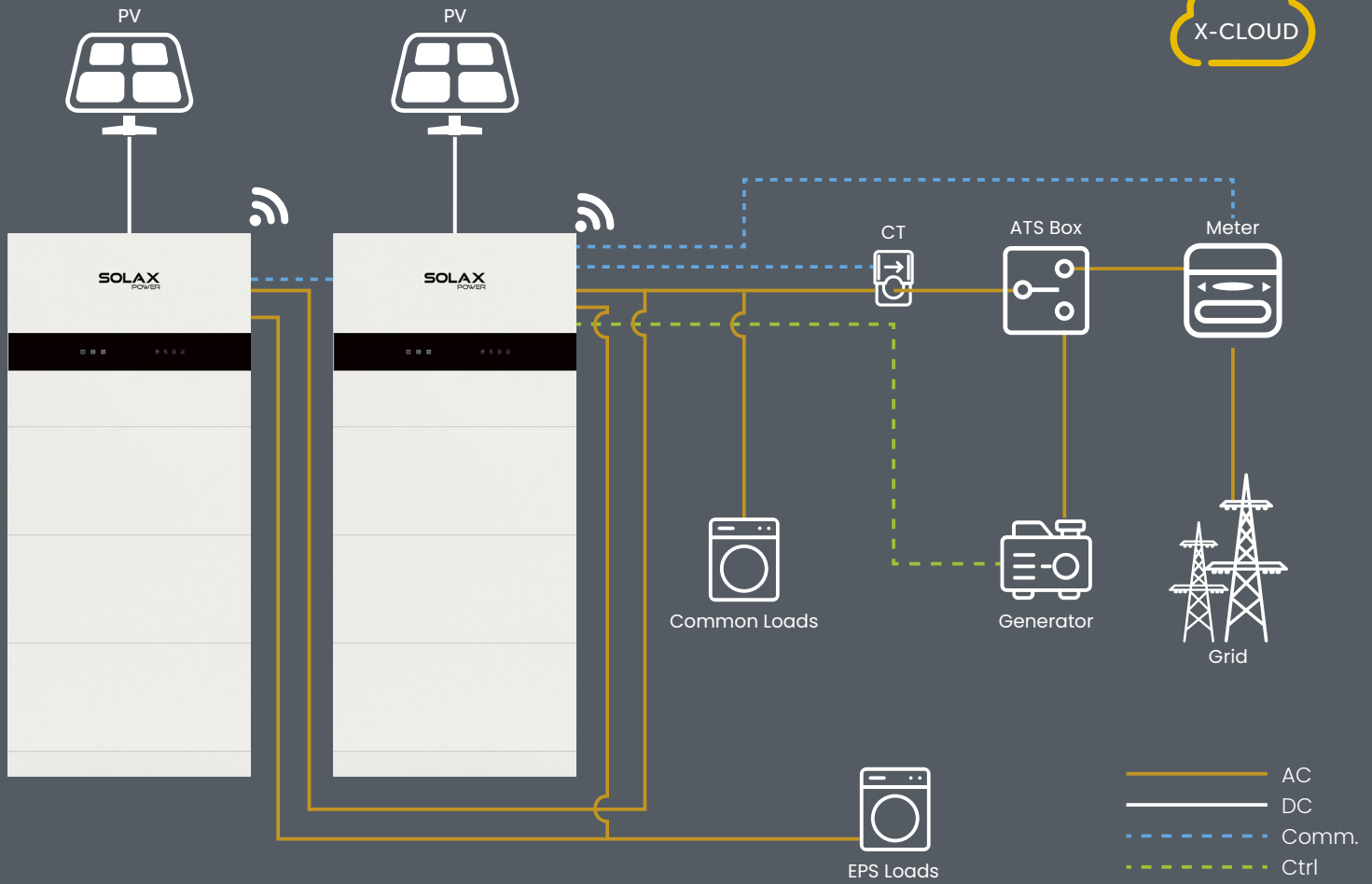

## EFFICIENCY CURVE

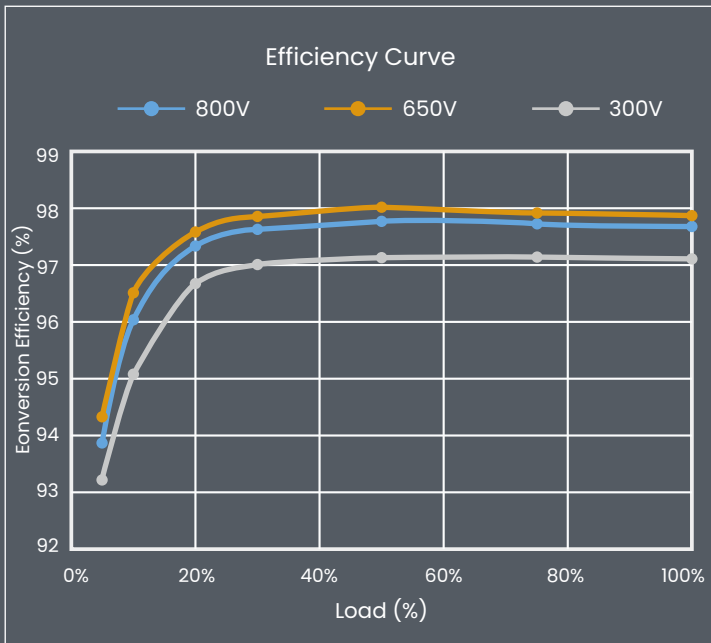

## DERATING CURVE

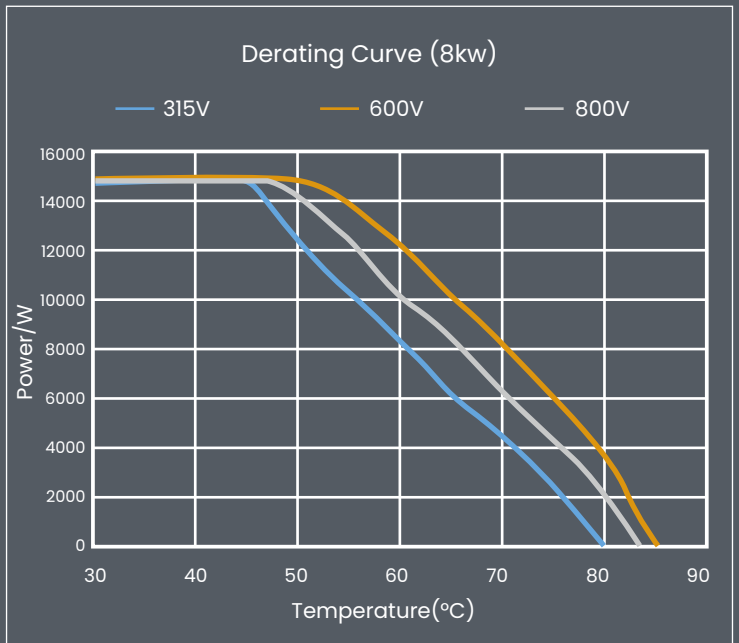

# CIRCUIT DIAGRAM

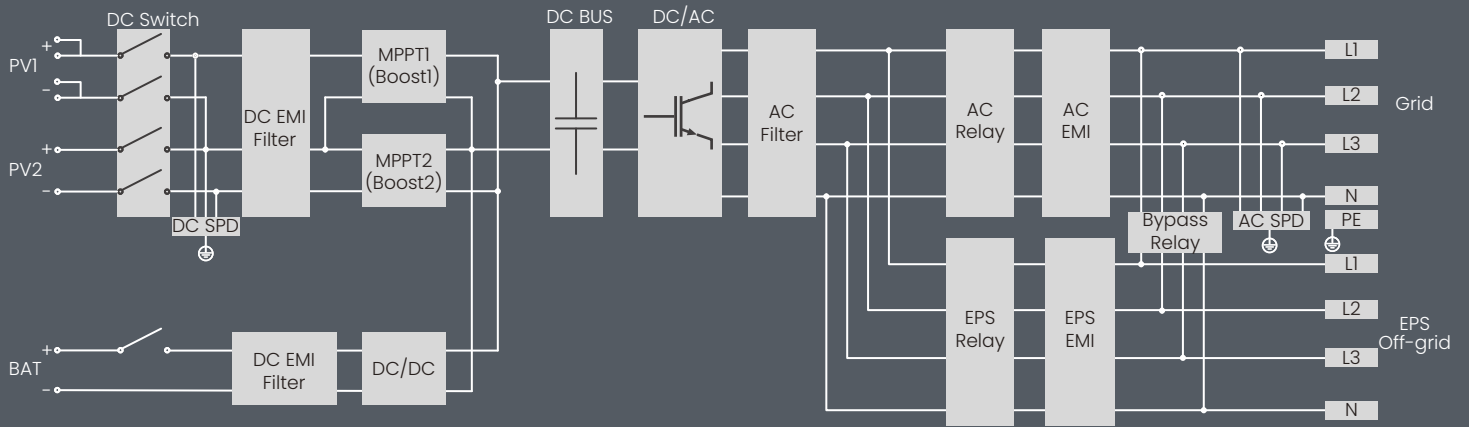

[www.solaxpower.com](http://www.solaxpower.com)

Global: +86 571-56260008  
PL: +48 662 430 292

AU: +61 1300 476 529  
DE: +49 (0) 6142 4091 664

UK: +44 2476 586998  
NED: +31 (0) 8527 37932

[info@solaxpower.com](mailto:info@solaxpower.com)  
[service@solaxpower.com](mailto:service@solaxpower.com)