

Specification

Prepared	Checked	Approved	Accepted	Confirmed	Approved

CE	RoHS	2835 SMD	120 LEDS/M	LED Strip	DC 48V	IP 20	3 Years
-----------	------	--------------------	----------------------	----------------------------	-----------	-----------------	-------------------

Model: RN08C0TH-A

5000*8, 600pcs 2835 SMD LED, bare board series , 48Vdc, constant voltage, LED flex strip

Features:

- ☉ 2835 SMD LEDs bring high luminous efficacy;
- ☉ one BIN only, good color uniformity;
- ☉ CE, ROHS compliant;

Figure:

Applications:

- ☉ Suitable for hotel, shopping mall, home, cabinet, show frame, etc. as main lighting, indirect lighting, cove lighting, contour lighting, decorative lighting, etc.

Warranty:

- ☉ 3 years or 13,000 hours, whichever comes first.
- ☉ Lifetime 36,000 hours.

Optical and Electrical Parameters:

P/N	LED Color	CCT (K) WL (nm)	CRI	SDCM	Beam Angle (°)	Luminous Flux (lm/m)	Luminous Efficacy (lm/W)	Working voltage (VDC)	Working current (mA)		Power (W/m)	
									1m[3 9.37in]	5m[1 5in]	1m[7in]	5m[1 5in]
RN08C0TH-A	White	3000	≥80	≤5	≥115	1000	105	48	200	895	9.6	43
RN08C0TH-A	White	4000	≥80	≤5	≥115	1075	112	48	200	895	9.6	43

Others:

P/N	IP Grade	Operating Temp		Storage Temp		Standard length		Max. cascading length		LED Qty (pcs)	Weight	
		(°C)	(°F)	(°C)	(°F)	(m)	(inch)	(m)	(inch)		(g/m)	(lb/m)
RN08C0TH-A	IP20	-25~ +60	-13~ +140	-25~ +70	-13~ +158	5	196.8	5	196.8	120	16	0.035

Notes:

- (1) Testing environment temperature: 25±2°C [77±3.6°F];
- (2) The actual data of each single product may differ from above typical data which are subject to change without prior notice;
- (3) The above "--" means the parameters are not required temporarily

Profile Drawings:

Unit: mm[inch]

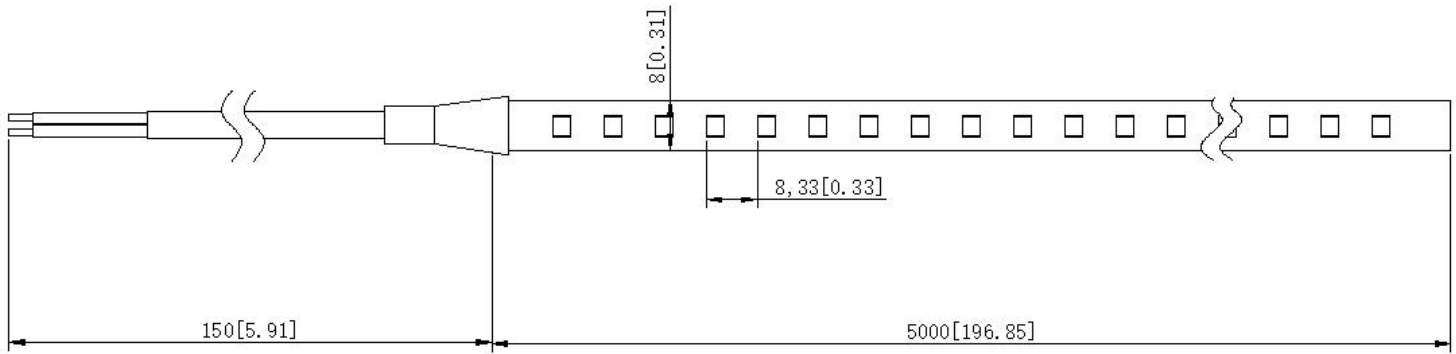

Light Distribution/Iso-illuminance Diagram:

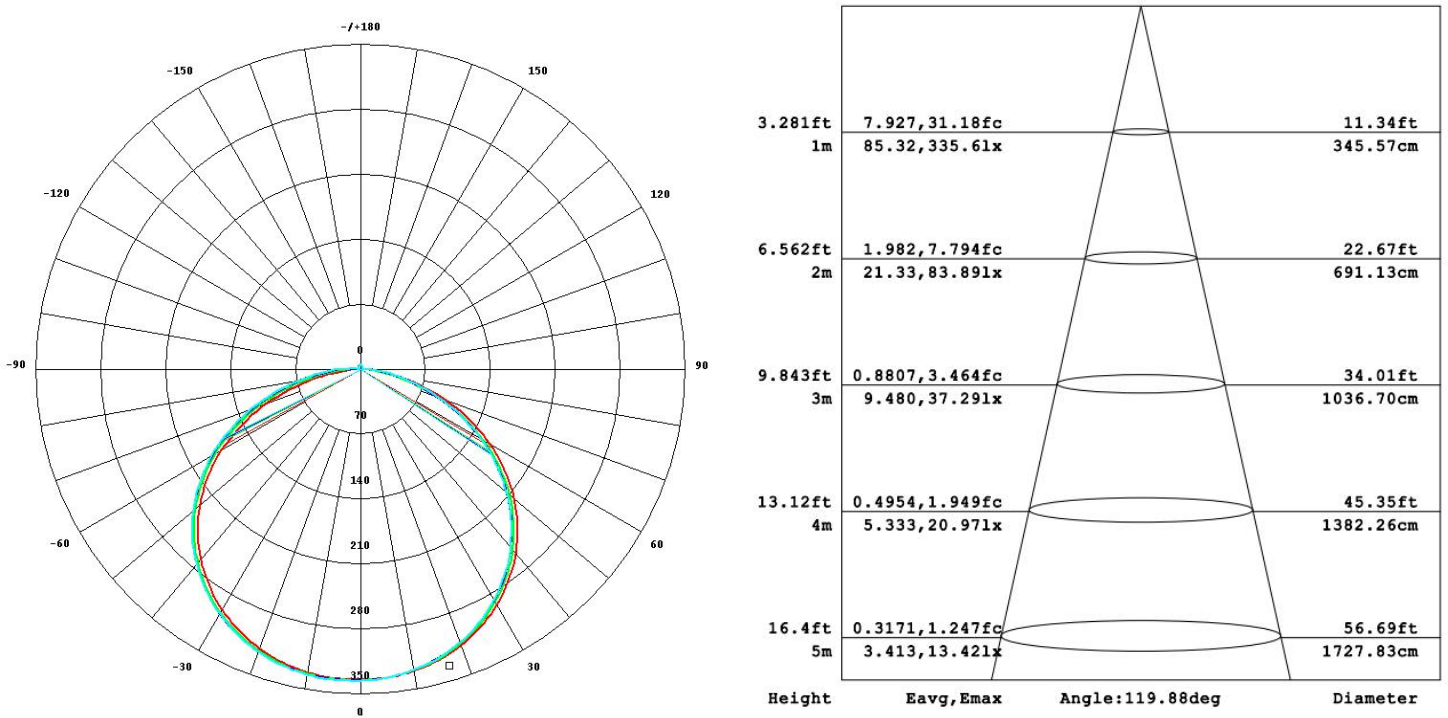

Packaging Information:

P/N	Qty (m/reel)	Qty (m/carton)	Total Qty (m)	Total weight		Outer carton					
								length		width	
				(Kg)	(lb)	(mm)	(inch)	(mm)	(inch)	(mm)	(inch)
RN08C0TH-A	5	200	200	4.1	9.02	405	15.94	256	10.07	238	9.37

Packaging Diagram:

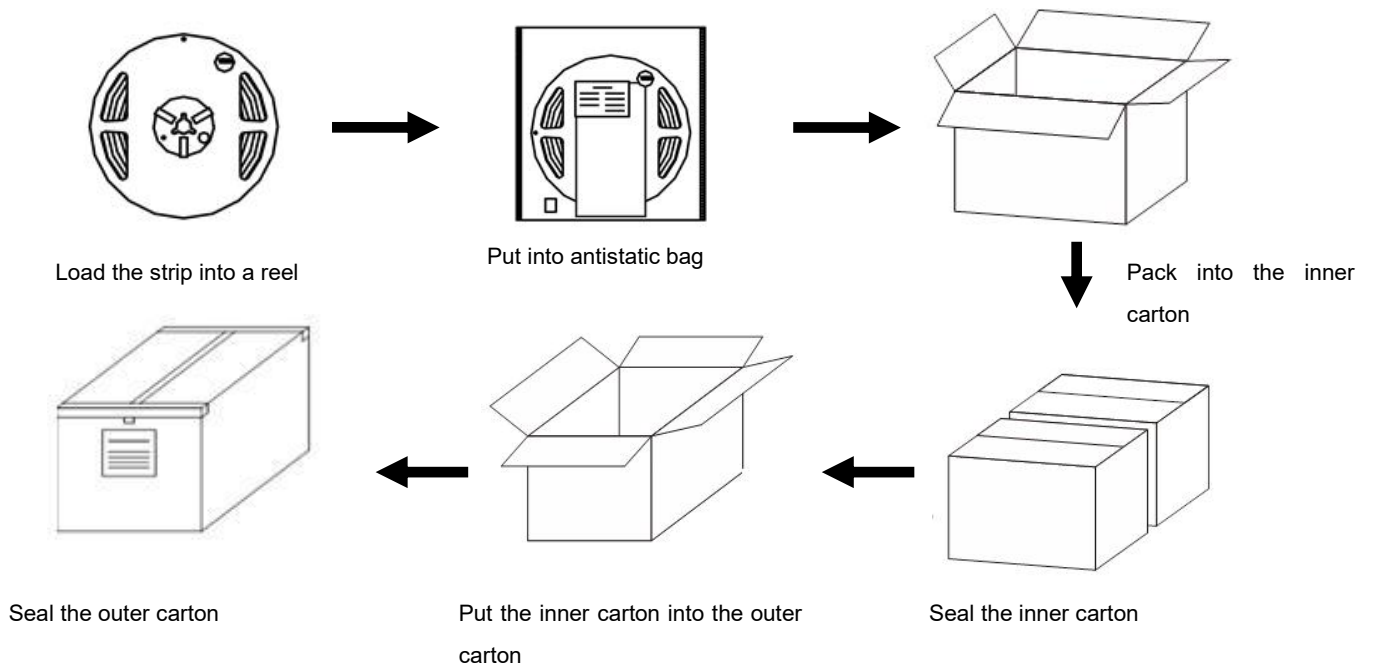

Connection Instruction:

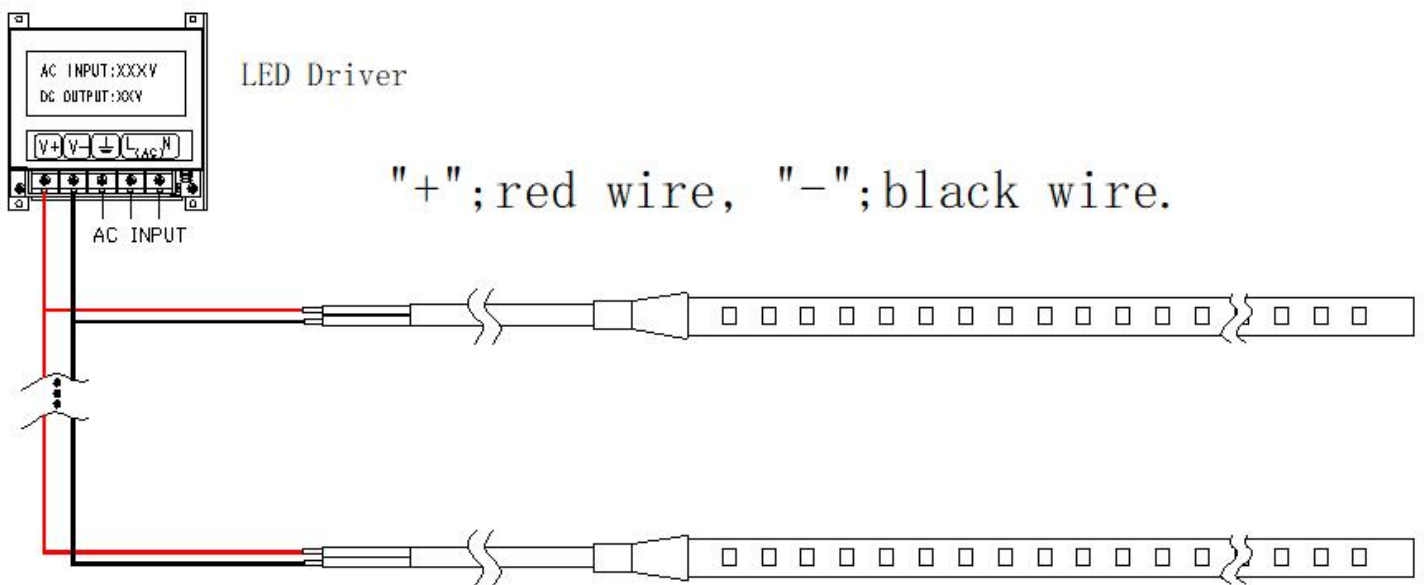

Note: Please connect the '+' and '-' of strips to those of driver output correctly.

Parts & Tools:

Product Spare Parts



LED Strip

Self-provided Tools



Electrical Drill & Drilling bit

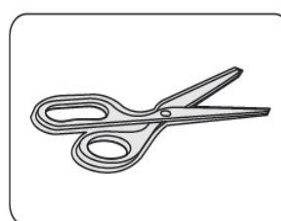

Scissors

Installation Steps & Cautions:

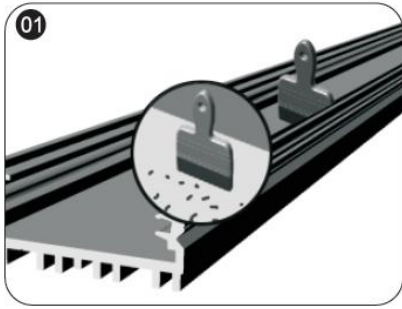

01 Make sure the mounting surface is clean before installation;

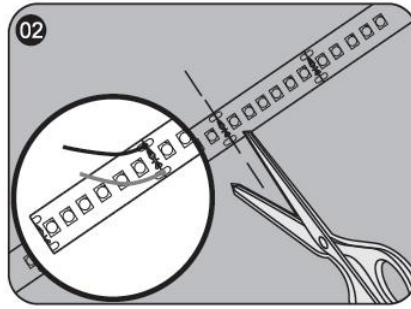

02 Calculate the needed length and cut off the extra length along cutting mark if necessary; if need to add wires, please weld them at the next location with printed mark

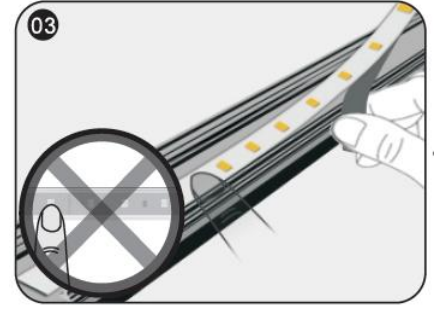

03 While sticking strips, peel off the release paper of the tape step by step. Don't peel off all release paper at a time to avoid getting your strip in a mess.
△Notes: No pressing the bead!



04 Stick Mylar tape to isolate the cutting position from the bottom of profile inner slot to avoid short-circuit;

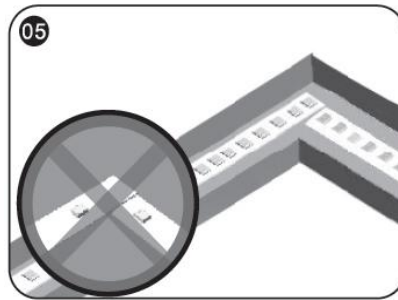

05 The installation at the corner is shown as the above figure.
△ Notes: No bending it into right angle; No twisting it to stick on the mounting surface.



06 Connect strip wires to the output terminal of power supply, and dispose with waterproof, insulation, short-circuit and anti-corrosion protection at both the wire joints and the cut section of your strip (if any).

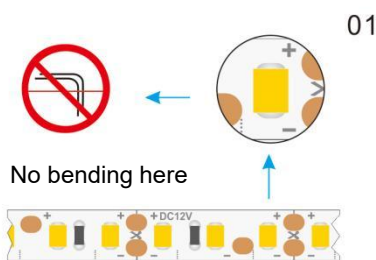

01 No bending the strip at the position of LED

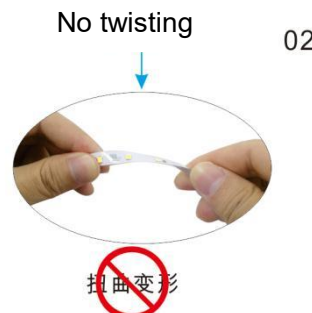



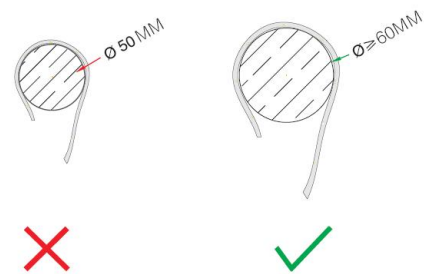

02 No twisting the strip



03 No winding an object with a diameter <5cm.

Optional Parts:

Category	Part Name	Figure	Specifications/Description	Article Number	Color	IP Grade	Notes
Snap-fit joints	Snap-fit joints		Snap-fit joints /23.5*4*2mm/QJ-KZ-10 (equipped with screws)	207-076	/	/	/
Terminal Connector	Connector		10mm width, single color, bare board LED strips/ cable-board connector /24.3*14.6*7.7mm	1CN-07-117	/	/	/
	Connector		10mm width, single color, bard board LED strips/board-board connector/19.55*14.6*7.7mm	1CN-07-123	/	/	/
	Connector		Connector /board-cable-board /10mm LED strips /16*12.4*4.5mm/QJ-SL-10XB-2/	1CN-07-074	Red and Black	IP33	/
	Connector		Connector / cable-board /10mm LED strips /16*12.4*4.5mm/QJ-SL-10XB-2/L=15CM	1CN-07-073	Red and Black	IP33	/
	Connector		Connector / board-board /10mm LED strips /20.6*12.4*4.5mm/QJ-SL-10BB-3/	1CN-07-078	/	/	/
	Connector		Connector /cable-cable /25*6.7*6.65mm/1P/QJ-XC-JXD-D1	1CN-07-065	/	/	/
	Connector		Connector / cable-cable /25*10.6*6.65mm/2P/QJ-XC-JXD-H2	1CN-07-066	/	/	/
	Connector		Connector / cable-cable /25*12.8*6.65mm/1P/QJ-XC-JXD-T1/	1CN-07-067	/	/	/
	Connector		Connector / cable-cable /28.6*16.6*6.65mm/2P/QJ-XC-JXD-T2/	1CN-07-068	/	/	/
	Connector		Connector / cable-cable /22*9.5*6mm/2P/QJ-XC-JXD-D2/	1CN-07-069	/	/	/

Troubleshooting:

Malfunctions	Possible Causes	Solutions
All LEDs don't work	1. The power supply did not connect to power grid.	Power on
	2. No electricity due to short-circuit of external power supply.	Remove the malfunction caused by short-circuit, power on again.
	3. The wires of strips connect to power supply output reversely.	Check the connecting and ensure the wires are connected correctly.
Part of LEDs don't work	1. Part of power supplies do not have output.	Check the power supply system.
	2. Part of wires of strips have malfunction.	
	3. Particular modules connected reversely.	Correct connection

Brightness of LEDs is weak or uneven	1. Overloaded power supply;	Replace it with higher power supply
	2. The power loss of power circuit is huge or the power loss of each circuit existing big difference.	Ensure working voltage of strips is within±5%V of rated voltage. 1. Shorten the length of wires between the first strip and power supply or replaced with wires with bigger diameter; 2. Ensure the cascading qty of string is less than or equal to the allowed maximum cascading qty, and each strip cascading qty is well-balanced.)
	3. Exceed in qty of strips in series	Lessen the cascading qty for strip and ensure the qty for each electrical circuit is within the maximum cascading qty.
LEDs are blinking	1. Poor contacted in the joints.	Find out and tackle malfunction immediately.
	2. Failures in power supply.	Power on

Declaration:

- ⊙ If the external flexible cable of light box is damaged, please replace it by its manufacturer or its service agent or qualified person to avoid a hazard.
- ⊙ The specific installation and cautions please refer to the user manual.
- ⊙ The given data in this specification is based on our standard product. There may be existed slight difference compared with actual products.
- ⊙ All Illustrations in this specification are for reference only.
- ⊙ This product is subject to change or modify without prior notice.
- ⊙ RISHANG OPTOELECTRONICS CO., LTD reserves the right of final explanation for this specification.

<End>

Rishang Optoelectronics Co., Ltd (stock code: 002654)

Add: Block 2, Hongfa jiateli High-Tech. Park Tangtou Ave., Shiyan, Bao'an Shenzhen
Guang Dong, 518108, China.
Tell: +86-755-36988588 E-mail: info@ledlamps.com.cn
Website: www.ledlamps.com.cn

Website

WeChat Account

