

2PBA 18

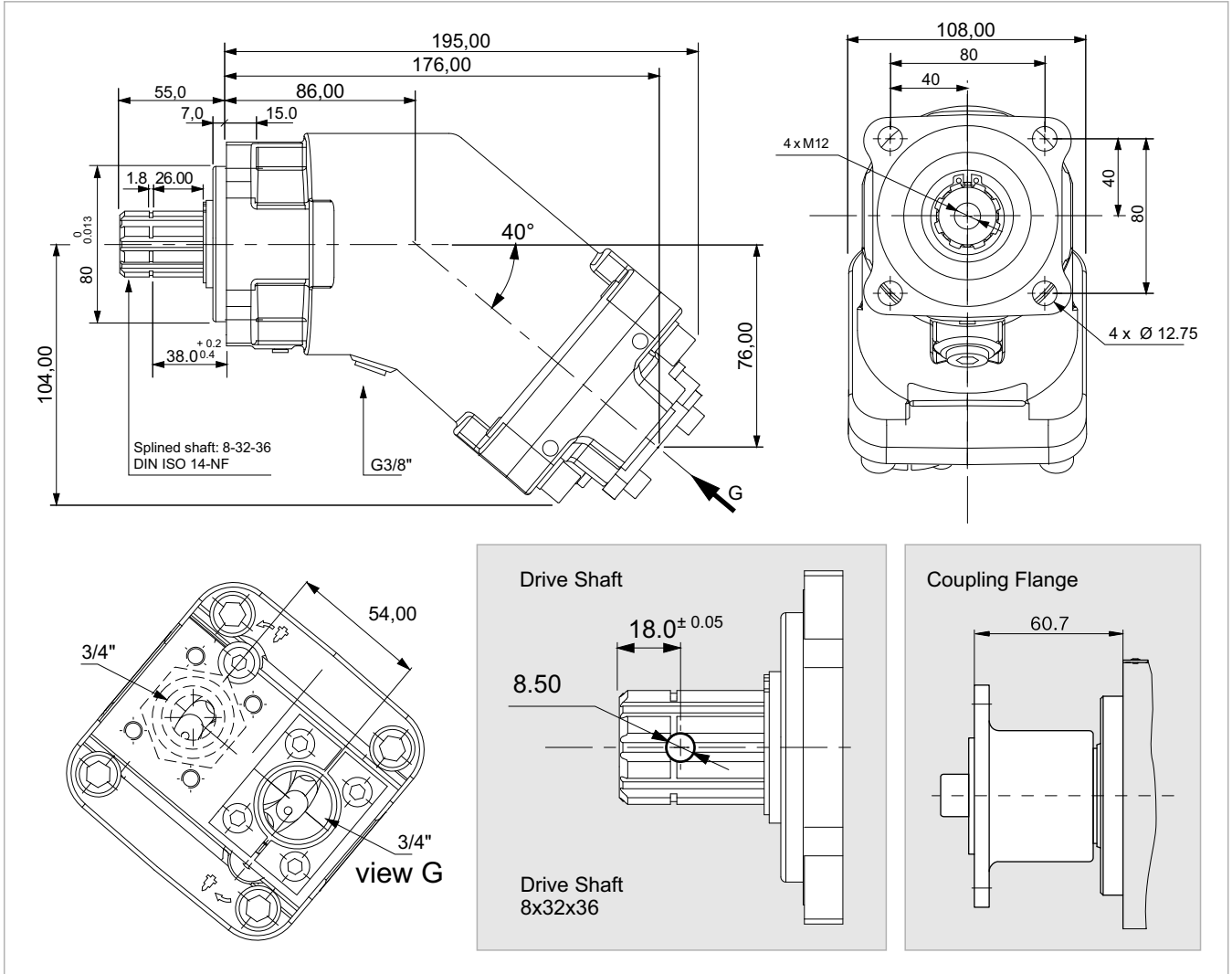

x 1000 rpm	18,00 cc
x 1500 rpm	27,00 cc
Max. Continuous Pump Speed	2300 rpm
Max. Limited Pump Speed	2900 rpm
Max. Continuous Pressure	350 bar
Max. Intermit. Peak Pressure	400 bar
Max. Torque at 350 bar	105 Nm
Weight without inlet fitting	9,00 kg
Weight with inlet fitting	9,40 kg
Torque without inlet fitting	8,75 N.m
Torque with inlet fitting	9,19 N.m
Rotation	CW-CCW
Fluid	Min.B.Hyd.Oil
Inlet & Outlet	3/4"

Flow, Speed, Pressure List of 2PBA 18

