

2PBA 32

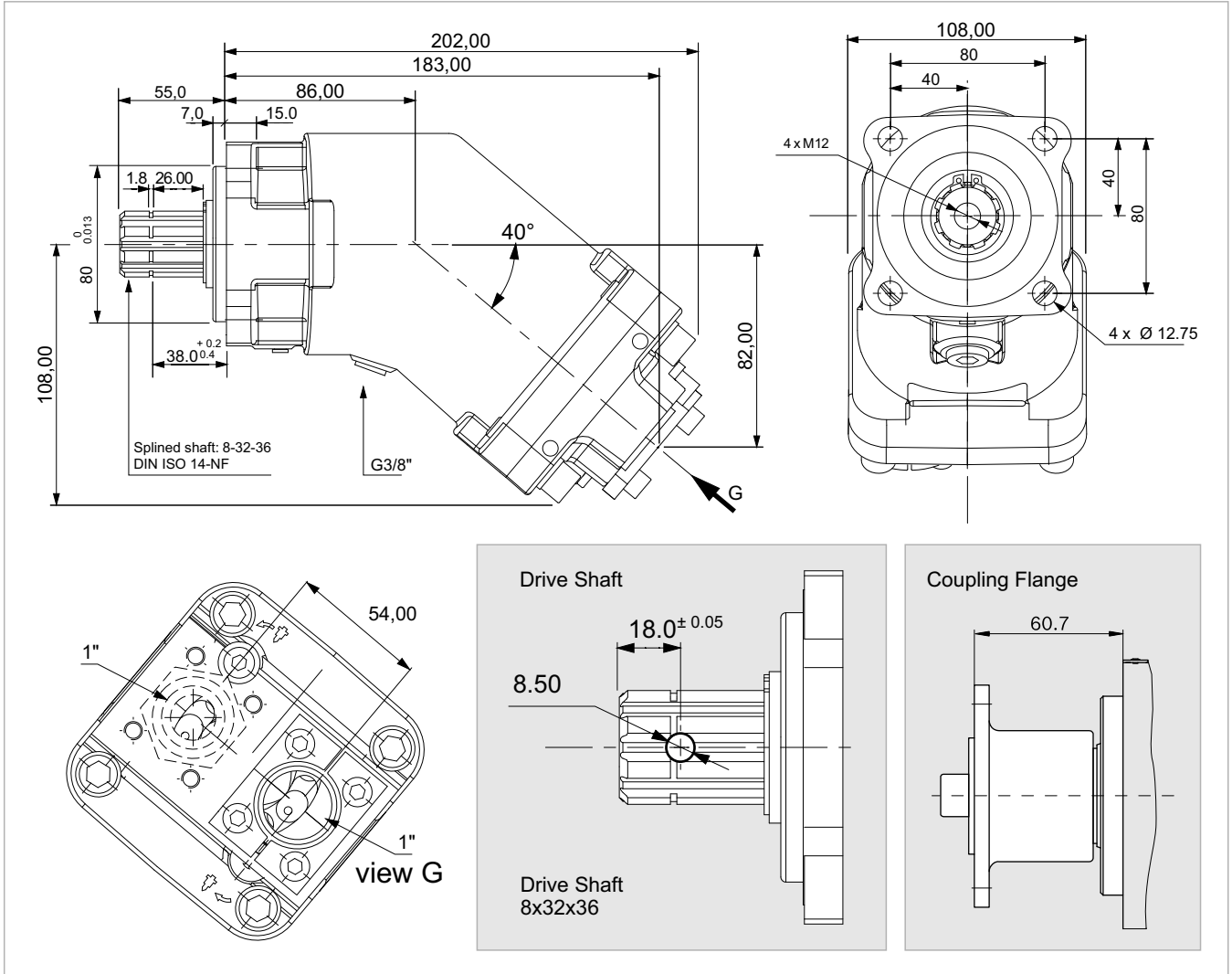

x 1000 rpm	32,00 cc
x 1500 rpm	48,00 cc
Max. Continuous Pump Speed	2250 rpm
Max. Limited Pump Speed	2700 rpm
Max. Continuous Pressure	350 bar
Max. Intermit. Peak Pressure	400 bar
Max. Torque at 350 bar	190 Nm
Weight without inlet fitting	10,50 kg
Weight with inlet fitting	10,90 kg
Torque without inlet fitting	11,00 N.m
Torque with inlet fitting	11,52 N.m
Rotation	CW-CCW
Fluid	Min.B.Hyd.Oil
Inlet & Outlet	1"

Flow, Speed, Pressure List of 2PBA 32

