



SOLECO frames |



SOLECO

frames |

At Soleco frames we have been working for years to offer you the best possible product. Hard work and know-how have borne fruit and here we present you with a range of Solutions for every type of door. Fixed and telescopic frames in steel, aluminium and stainless steel, to ensure that the design is never compromised by the quality.

contents

Fixed Steel (F)

- A. Adaptability and strength (4-5)
- B. Solutions in Steel (6-15)
- C. Designs in Steel (16-17)
- D. F-Standard F1, F2, F3 (18)
- E. F-Dekor (19)
- F. F-7 2 Decorations (20)
- G. F-line (21)
- H. F-Corner Exterior (22)
- I. F-Corner Interior (23)
- J. F-Intermediate (24)
- K. F-2 Rebates (25)
- L. F-H Type H (26)
- M. F-Swinging (27)

4-27

Steel Telescopic(G)

- A. G-Standard G1/G2/G3 (30)
- B. G-Dekor (31)
- C. G-7 Decorations (32)
- D. G-2 Rebates (33)
- E. G-Type H (34)
- F. G-Swinging (35)

28-35

S

Specials in Steel

- A. E-Ei Fire resistant (38)
- B. E-EMP Radiation-proof (39)
- C. E-CFT Open Pocket sliding (40)
- D. E-CET Pocket sliding (41)
- E. EN-INT Flush with wall, inward opening (42)
- F. EN-EXT Flush with wall, outward opening (43)
- G. E-30dB Soundproofed (44)

36-45

O

StainlessSteel

- A. Solutions in Stainless steel (48-49)
- B. Standard (50)
- C. Transom Solutions (51)
- D. CFT Stainless. Open pocket sliding(52)
- E. CET Stainless. Pocket sliding(53)

46-53

Assembly Information F/G

- A. Fixed (56)
- B. Telescopic (57)

54-57

Aluminium

- A. Solutions in Aluminium (60-67)
- B. Designs in Aluminium (68-69)
- C. Standard curve AL1/AL2/AL3 (70)
- D. Standard straight ALR1/ALR2/ALR3 (71)

58-71

Specials in Aluminium

- A. AL-CFT Open pocket sliding (74)
- B. AL-CET Pocket sliding (75)
- C. AL-Swinging (76)
- D. AL-EMP Radiation-proof (77)
- E. EN-INT Flush mounted, inward opening (78)
- F. EN-INT Flush mounted, outward opening (79)

72-79

E

Mounting Characteristics AL

- A. Fixed (82)
- B. Telescopic (83)

80-83

C

Wardrobes and Closets

- A. Solutions (86)
- B. Designs (87)

84-87

Windows

- A. Solutions (90)
- B. Designs (91)
- C. Tilt window (92)
- D. Double glazed window (93)
- E. Sliding window (93)

88-93

O

Partitions

- A. Solutions (96-97)
- B. Designs (98-99)

94-99

Accessories

- A. Hardware (102-103)
- B. Lock escutcheon plates (104)
- C. Protectors and reducers (105)

100-105

Door furniture and complements

- A. Door kick plates (108)
- B. Edge protectors (109)
- C. Anti-slam (110)
- D. Porthole (111)
- E. Beading for Windows (111)
- F. Skirting (112)
- G. Wall protectors (113)

106-113

frames

Quality

- A. Steel and aluminium (116-117)
- B. Paint quality certification (118)

114-119







steel

Adaptability and strength

Frames adaptable to every space. Whatever the profile chosen you will find a frame that is resistant to everyday use and the passage of time. Complete Solutions in any colour. With steel maintenance costs are economised.

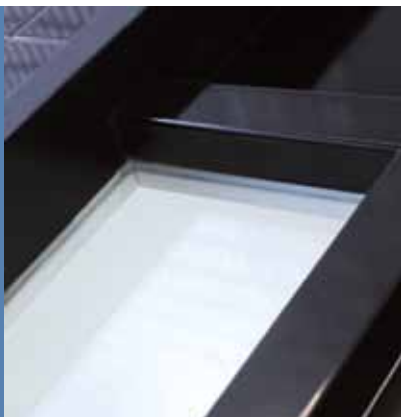

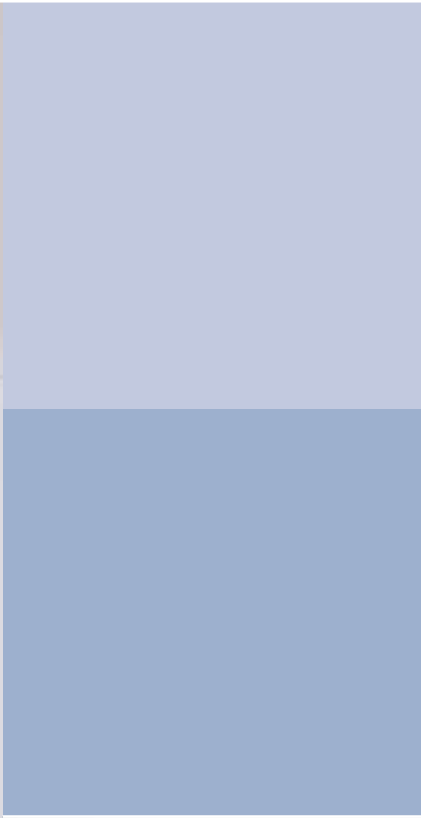
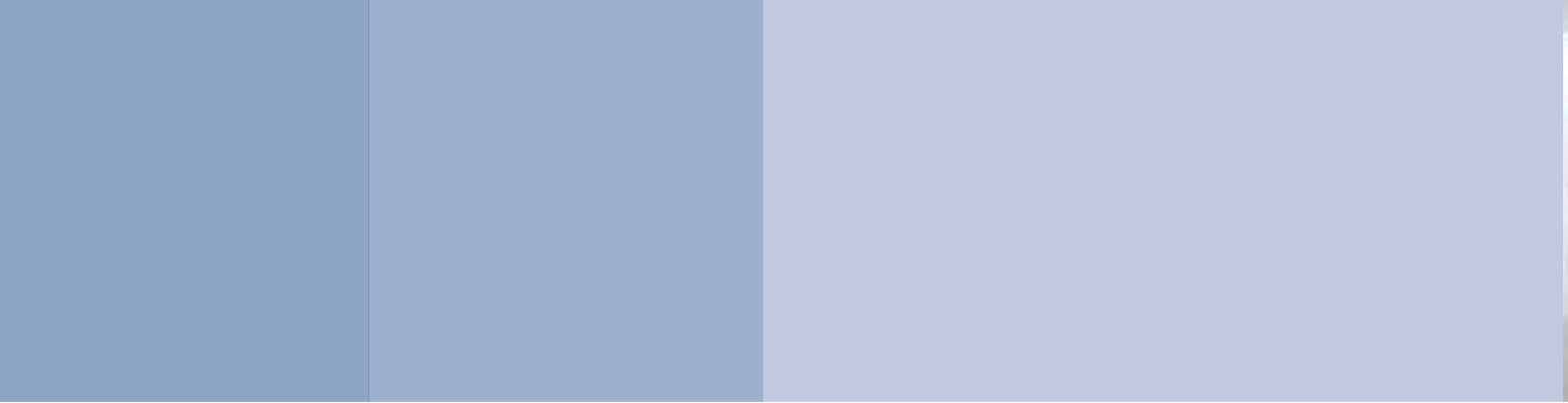

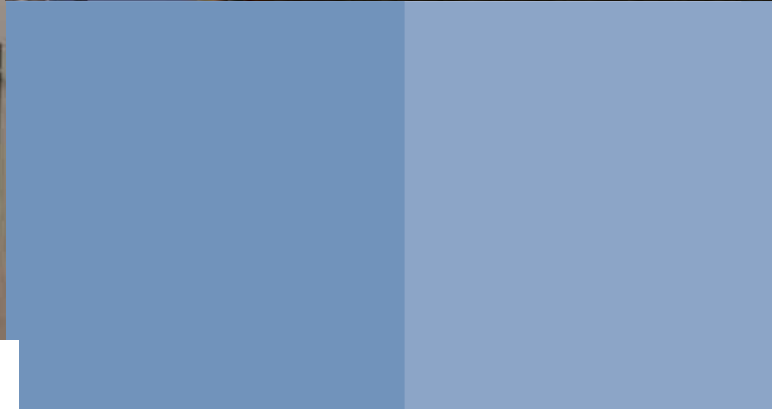
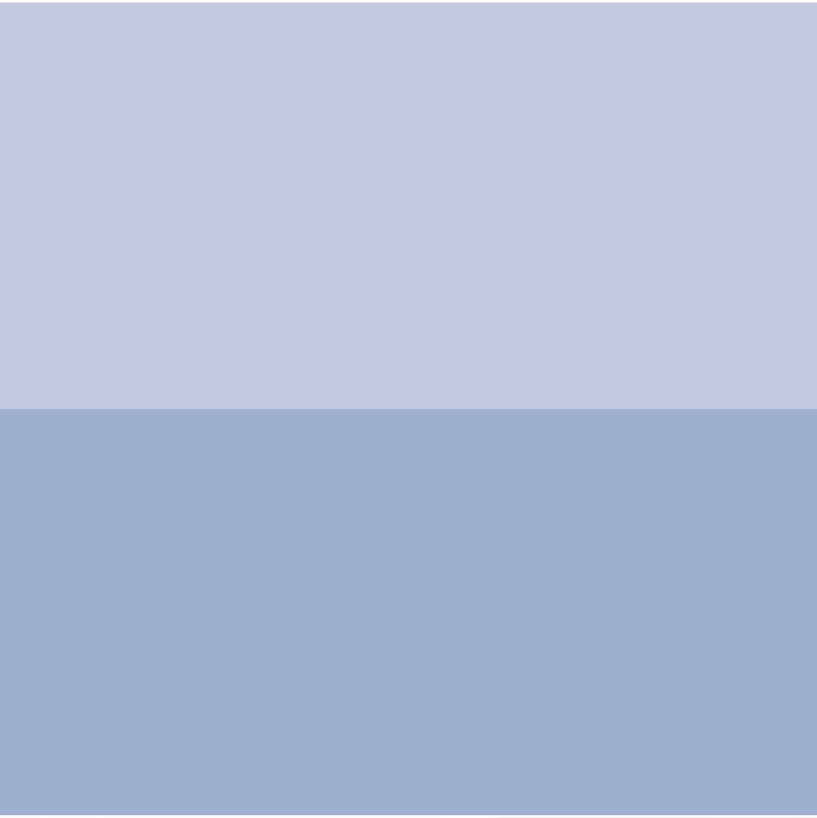





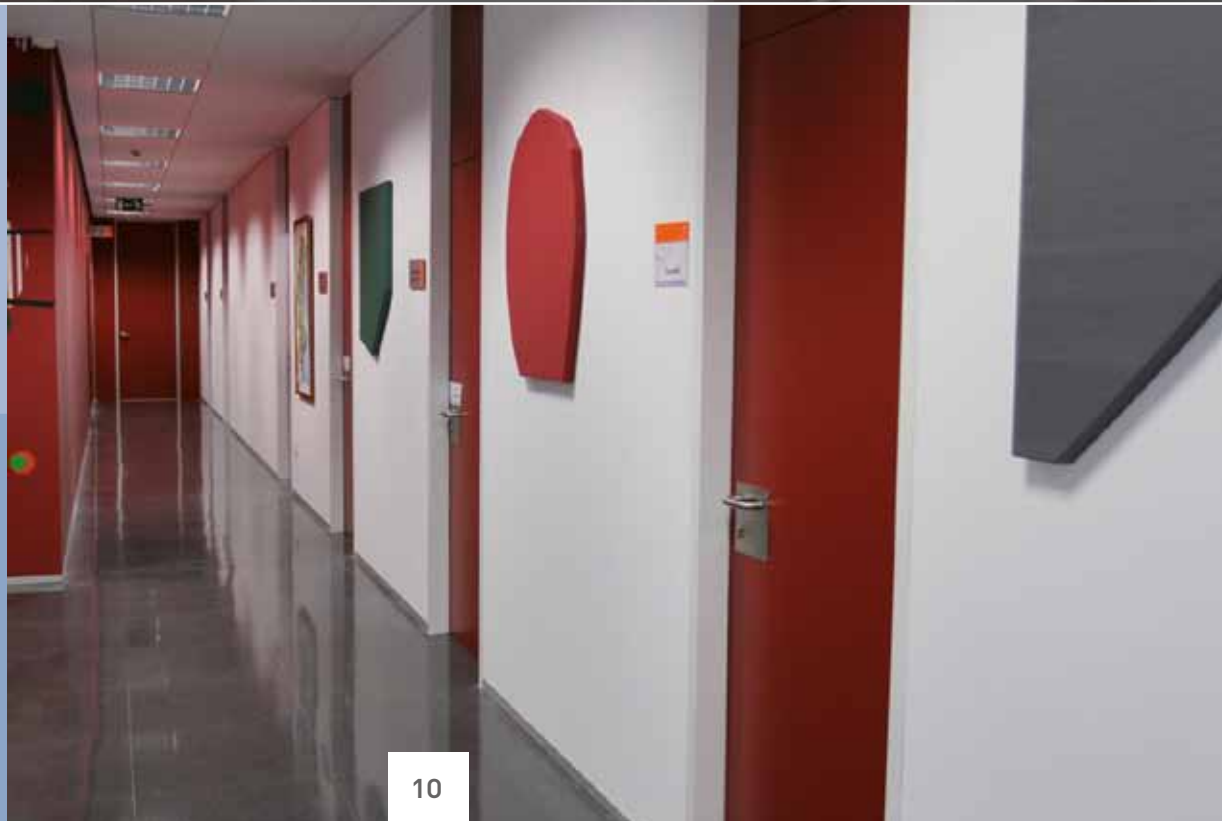







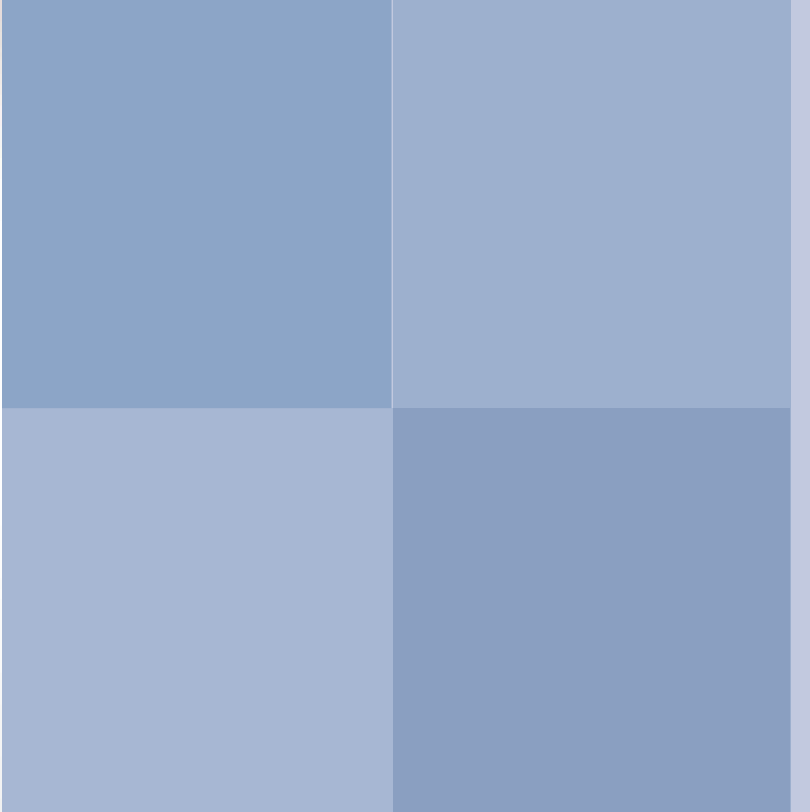



STEEL FRAMES APPLIED DIRECT TO THE WALL (FIXED)

types of frames

Profile of a single piece for fixed width of wall. All the frames (fixed) are applied direct to the wall, except the interior corner, exterior corner, intermediate and narrow.

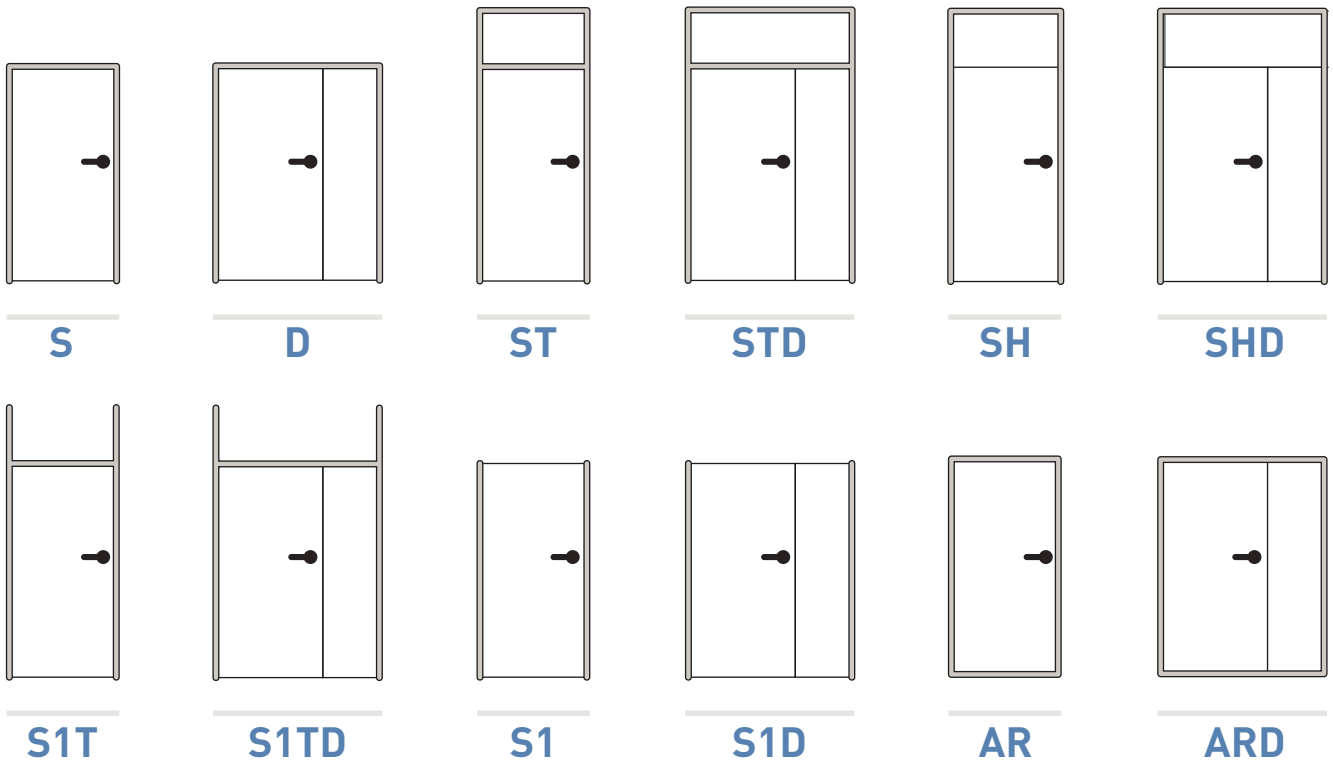

sliding

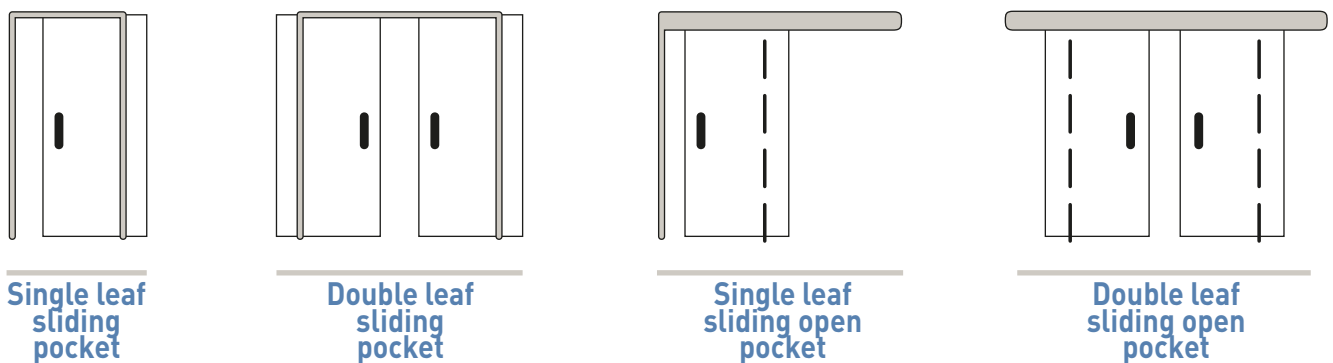

INSTALLATION DURING WALL CONSTRUCTION

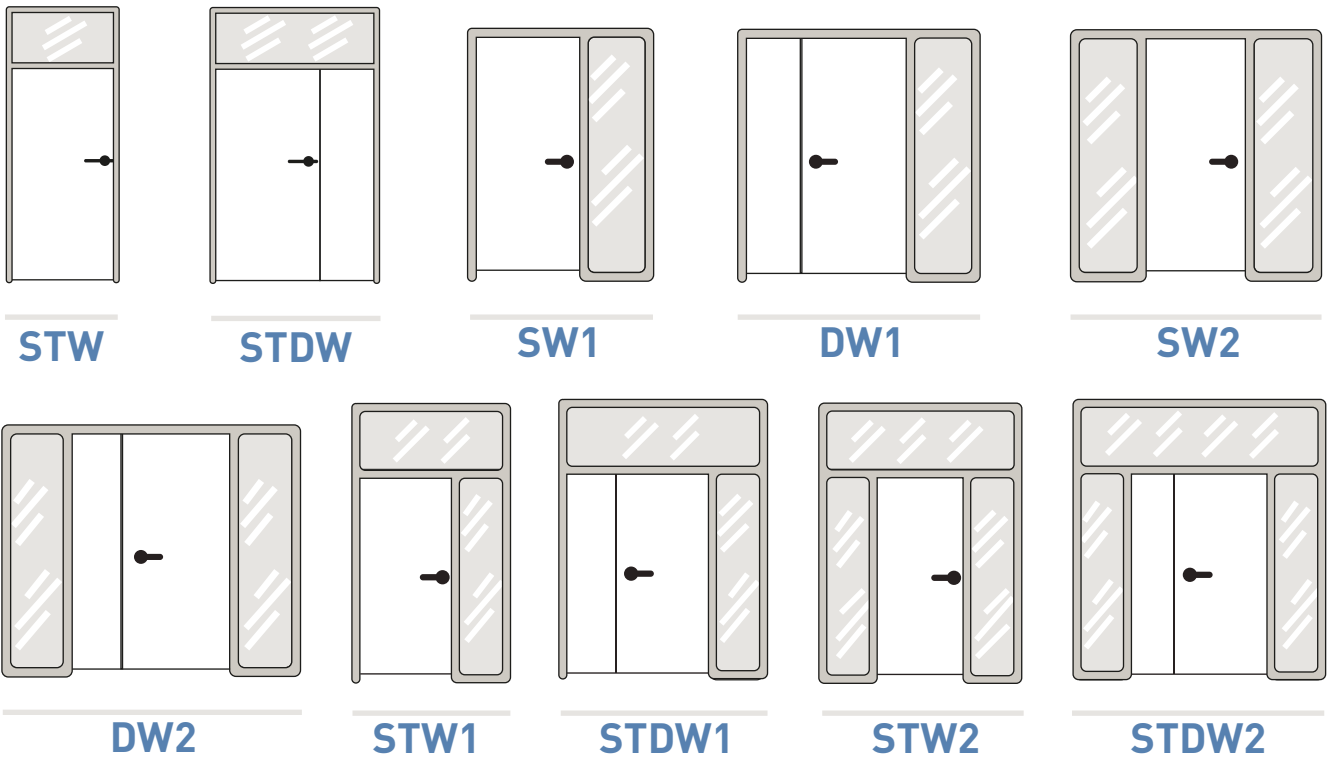

allows intermediate rails to be added

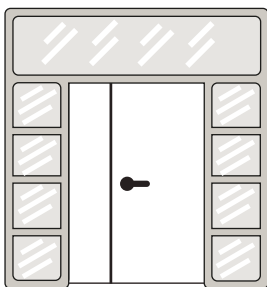

Example of horizontal rails

TYPE F

F1 / F2 / F3

F STANDARD

profiles

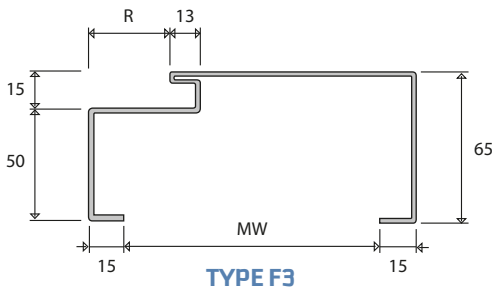
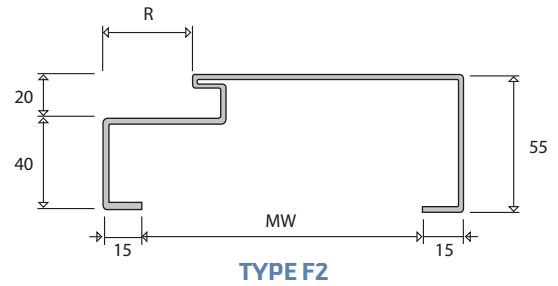
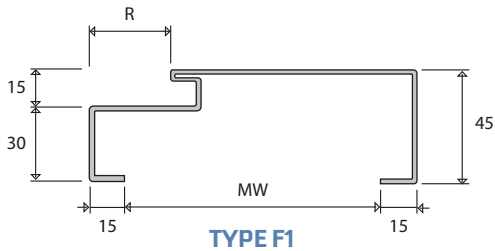

R: 35, 40, 45, 50 mm

MW: Thickness of finished wall 8, 9, 10, 11, 12, 13, 14, 15, 16, 17, 18, 19, 20, 21, 22, 23, 24 cm

section



specifications

Characteristics: Single piece frame applied directly to the wall.

Applications: Brick and drywall with fixing elements.

Mounting system: During the construction of the wall. Does not require a wooden pre-frame. **Knock Down System®**.

Materials: 1,5 mm galvanised steel and 1,2 mm stainless steel.

Types of frames: All (see pages 16-17).

Finishes: Pre-painted galvanised steel or matt stainless steel (with protective film).

Hardware: Standard adjustable door hinge, adjustable hinge, spring hinge and concealed hinge.

TYPE F

FDEKOR

DEKOR

profile

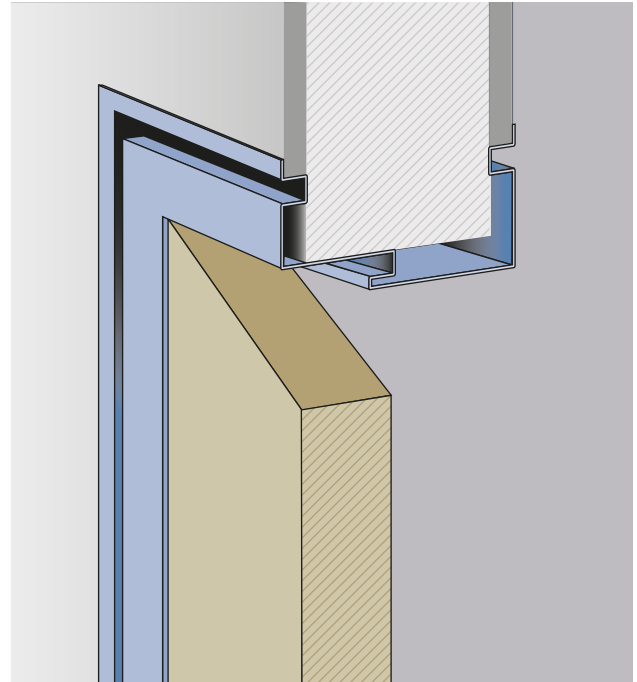
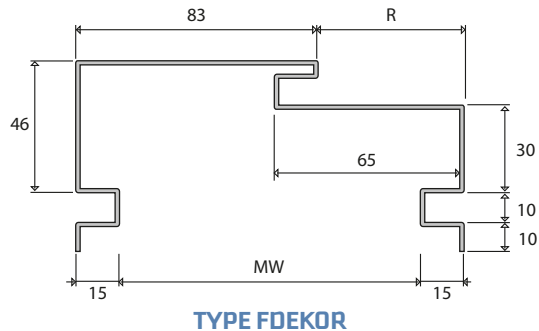

R: 35, 40, 45, 50 mm

MW: Thickness of finished wall 8, 9, 10, 11, 12, 13, 14, 15, 16, 17, 18, 19, 20, 21, 22, 23, 24 cm

section



specifications

Characteristics: Single piece frame applied directly to the wall with a "U" border.

Applications: Brick and drywall with fixing elements.

Mounting system: During the construction of the wall. Does not require a wooden pre-frame. **Knock Down System®.**

Materials: 1,5 mm galvanised steel and 1,2 mm stainless steel.

Types of frames: All (see pages 16-17).

Finishes: Pre-painted galvanised steel or matt stainless steel (with protective film).

Hardware: Standard adjustable door hinge, adjustable hinge, spring hinge and concealed hinge.

TYPE F

F7

2DEC

profile

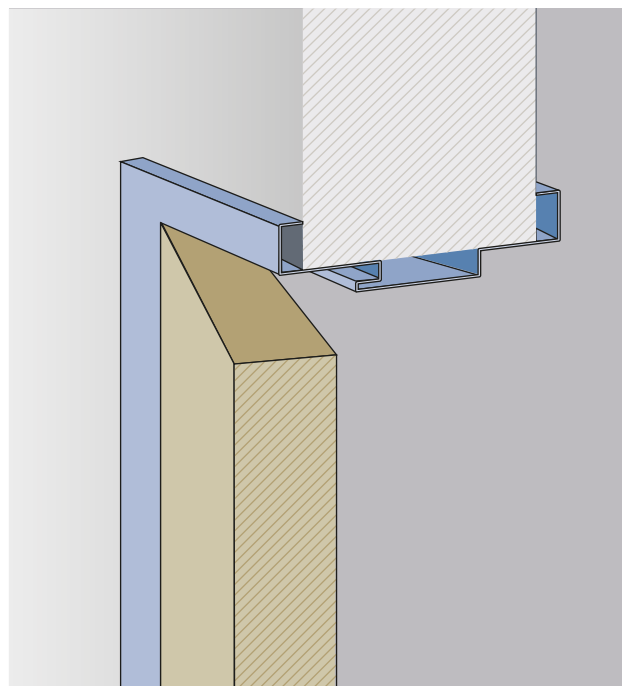
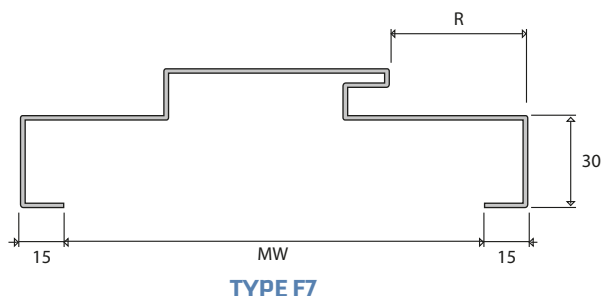

R: 35, 40, 45, 50 mm

MW: Thickness of finished wall 8, 9, 10, 11, 12, 13, 14, 15, 16, 17, 18, 19, 20, 21, 22, 23, 24 cm

section



specifications

Characteristics: Single piece frame applied directly to the wall.

Applications: Brick and drywall with fixing elements.

Mounting system: During the construction of the wall. Does not require a wooden pre-frame. **Knock Down System®.**

Materials: 1,5 mm galvanised steel and 1,2 mm stainless steel.

Types of frames: All (see pages 16-17).

Finishes: Pre-painted galvanised steel or matt stainless steel (with protective film).

Hardware: Standard adjustable door hinge, adjustable hinge, spring hinge and concealed hinge.

TYPE F FLINE

LINE

profile

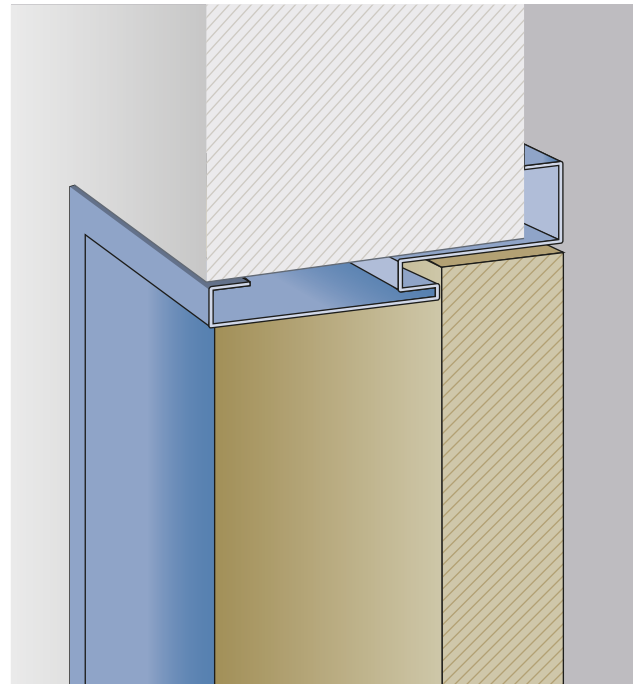
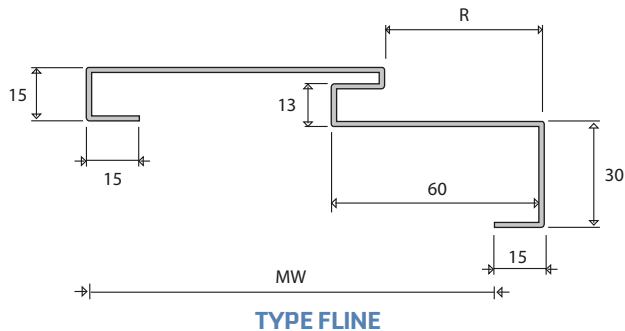

R: 35, 40, 45, 50 mm

MW: Thickness of finished wall 8, 9, 10, 11, 12, 13, 14, 15, 16, 17, 18, 19, 20, 21, 22, 23, 24 cm

section



specifications

Characteristics: Single piece frame applied directly to the wall.

Applications: Brick and drywall with fixing elements.

Mounting system: During the construction of the wall. Requires a shaped wooden pre-frame. Interior screws to the rebate of the pre-frame with hidden screws. **Knock Down System®.**

Materials: 1,5 mm galvanised steel and 1,2 mm stainless steel.

Types of frames: All (see pages 16-17).

Finishes: Pre-painted galvanised steel or matt stainless steel (with protective film).

Hardware: Standard adjustable door hinge, adjustable hinge, spring hinge and concealed hinge.

TYPE F

FESQ-EXT

CORNER

EXTERIOR

profile

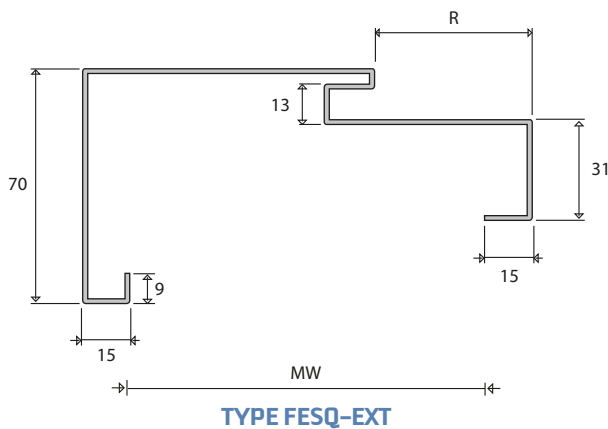

R: 35, 40, 45, 50 mm

MW: Thickness of finished wall 8, 9, 10, 11, 12, 13, 14, 15, 16, 17, 18, 19, 20, 21, 22, 23, 24 cm

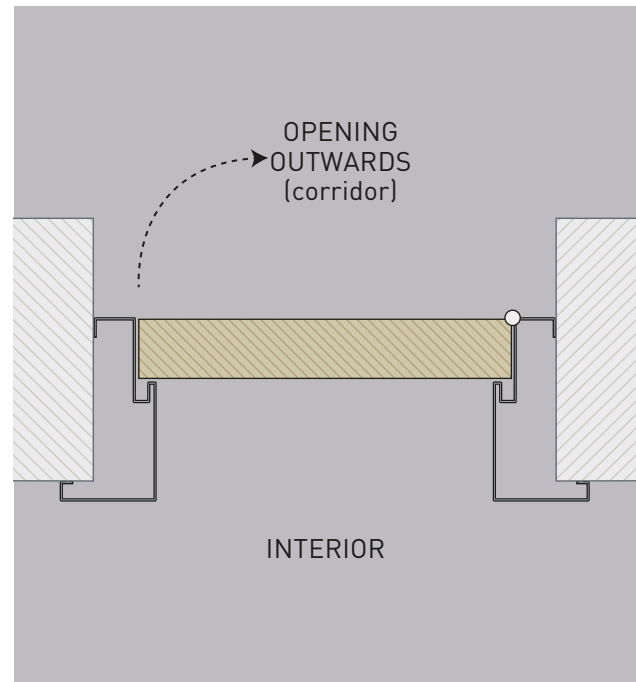

section



specifications

Characteristics: Single piece frame applied directly to the wall. Especially recommended for thick walls.

Applications: Brick and drywall with fixing elements.

Mounting system: Upon completion of construction. Mounting using screws hidden in the rebate. Does not require a pre-frame. **Knock Down System®**.

Materials: 1,5 mm galvanised steel and 1,2 mm stainless steel.

Types of frames: All (see pages 16-17).

Finishes: Pre-painted galvanised steel, matt stainless steel (with protective film) or RAL lacquer.

Hardware: Standard adjustable door hinge, adjustable hinge, spring hinge and concealed hinge.

TYPE F FESQ-INT

CORNER INTERIOR

profile

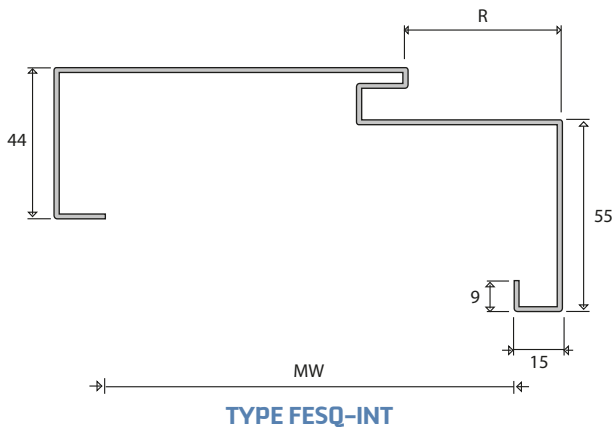

R: 35, 40, 45, 50 mm

MW: Thickness of finished wall 8, 9, 10, 11, 12, 13, 14, 15, 16, 17, 18, 19, 20, 21, 22, 23, 24 cm

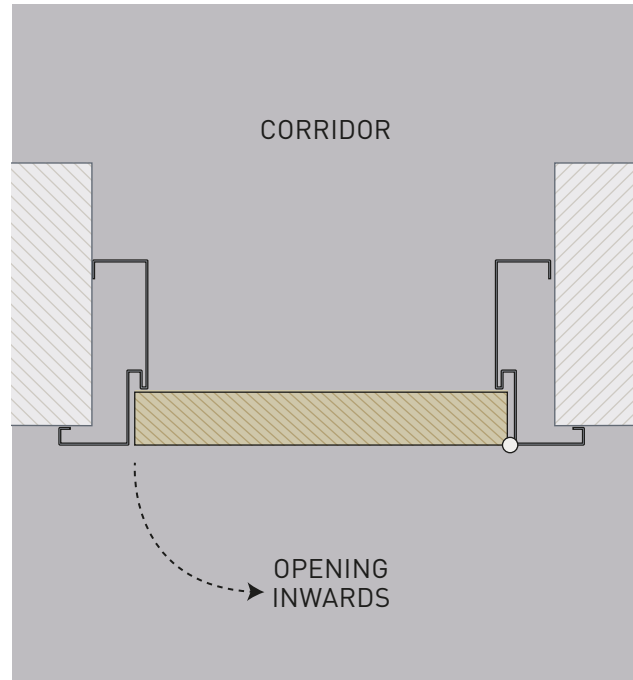

section



specifications

Characteristics: Single piece frame applied directly to the wall. Especially recommended for thick walls.

Application: Brick and drywall with fixing elements.

Mounting system: Upon completion of construction. Mounting using screws hidden in the rebate. Does not require a pre-frame. **Knock Down System®**.

Materials: 1,5 mm galvanised steel and 1,2 mm stainless steel.

Types of frames: All (see pages 16-17).

Finishes: Pre-painted galvanised steel, matt stainless steel (with protective film) or RAL lacquer.

Hardware: Standard adjustable door hinge, adjustable hinge, spring hinge and concealed hinge.

TYPE F FINTER

INTERMEDIATE

profile

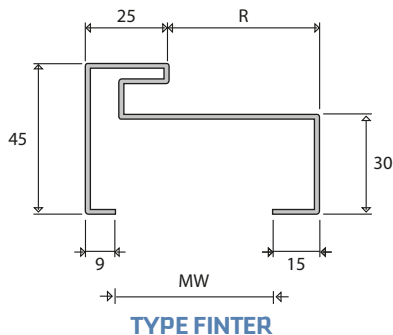

R: 40, 45, 50 mm

MW: Thickness of finished wall 8 cm.

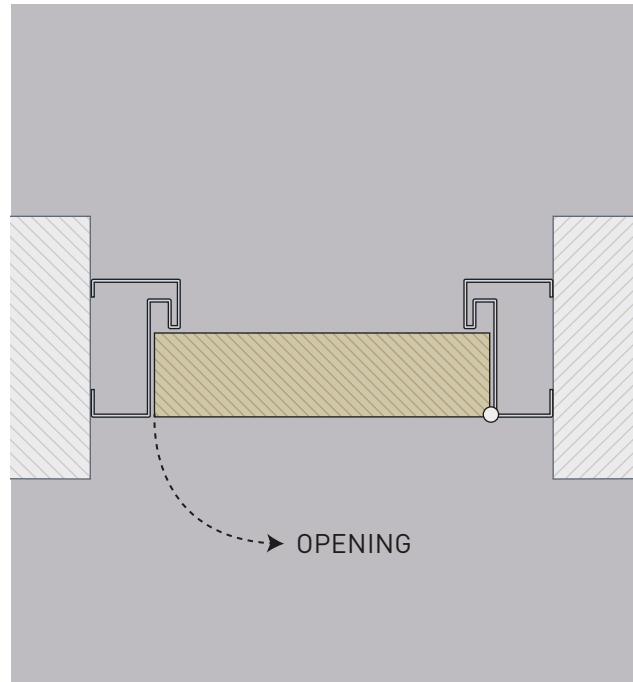

section



specifications

Characteristics: Single piece frame applied directly to the wall. Especially recommended for thick walls.

Application: Brick and drywall with fixing elements.

Mounting system: Upon completion of construction. Mounting using screws hidden in the rebate. Fitting after walling. Does not require a pre-frame. **Knock Down System®.**

Materials: 1,5 mm galvanised steel and 1,2 mm stainless steel.

Types of frames: All (see pages 16-17).

Finishes: Pre-painted galvanised steel, matt stainless steel (with protective film) or RAL lacquer.

Hardware: Standard adjustable door hinge, adjustable hinge, spring hinge and concealed hinge.

TYPE F F2GALCE

DOUBLE REBATE

profile

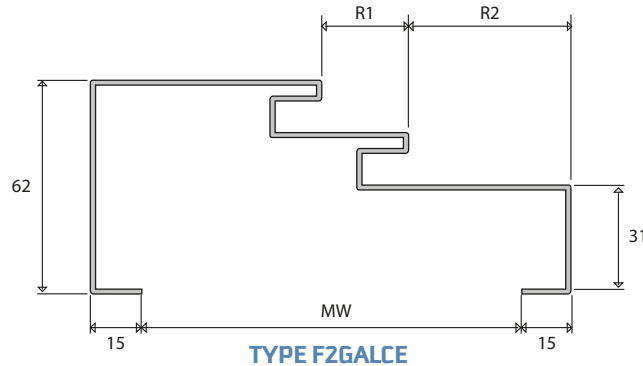

R1: Difference
R2: 35, 40, 45, 50 mm

MW: Thickness of finished wall 8, 9, 10, 11, 12, 13, 14, 15, 16, 17, 18, 19, 20, 21, 22, 23, 24 cm

section



specifications

Characteristics: Single piece frame with two rebates applied directly to the wall.

Application: Recommended for **sound-proofing**.

Mounting system: During construction of the walls. Does not require a pre-frame. **Knock Down System®**.

Materials: 1,5 mm galvanised steel and 1,2 mm stainless steel.

Types of frames: All (see pages 16-17).

Finishes: Pre-painted galvanised steel or matt stainless steel (with protective film).

Hardware: Standard adjustable door hinge, adjustable hinge, spring hinge and concealed hinge.

TYPE F

FH

TYPE H

profile

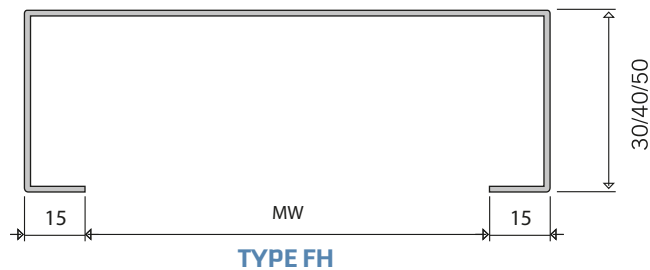

MW: Thickness of finished wall 8, 9, 10, 11, 12, 13, 14, 15, 16, 17, 18, 19, 20, 21, 22, 23, 24 cm

section



specifications

Characteristics: Single piece frame especially recommended for use in transit areas without doors or open pocket sliding doors.

Applications: Brick and drywall with their respective fixing elements.

Mounting system: During construction of the walls. Does not require a pre-frame. **Knock Down System®**.

Materials: 1,5 mm galvanised steel and 1,2 mm stainless steel.

Types of frames: All (see pages 16-17).

Finishes: Pre-painted galvanised steel or matt stainless steel (with protective film).

TYPE F FVAIVÉN

SWING DOOR

profile

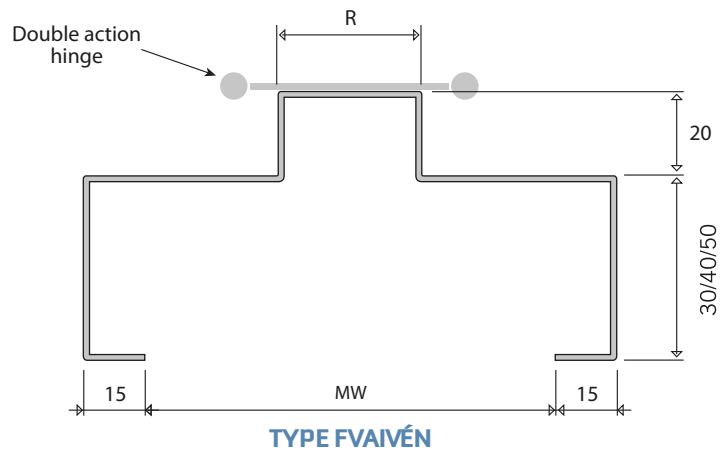

R: 35, 40, 45 mm

MW: Thickness of finished wall 8, 9, 10, 11, 12, 13, 14, 15, 16, 17, 18, 19, 20, 21, 22, 23, 24 cm

section



specifications

Characteristics: Single piece frame applied directly to the wall.

Application: For swing doors. Does not include hinges.

Mounting system: During walling. Does not require a pre-frame. **Knock Down System®**.

Materials: 1,5 mm galvanised steel and 1,2 mm stainless steel.

Types of frames: All (see pages 16-17).

Finishes: Pre-painted galvanised steel or matt stainless steel (with protective film).

Hardware: Double action hinges only. Not included.

TELESCOPIC STEEL FRAMES (G)

types of frames

Profile of two pieces, fitted after walling is completed.

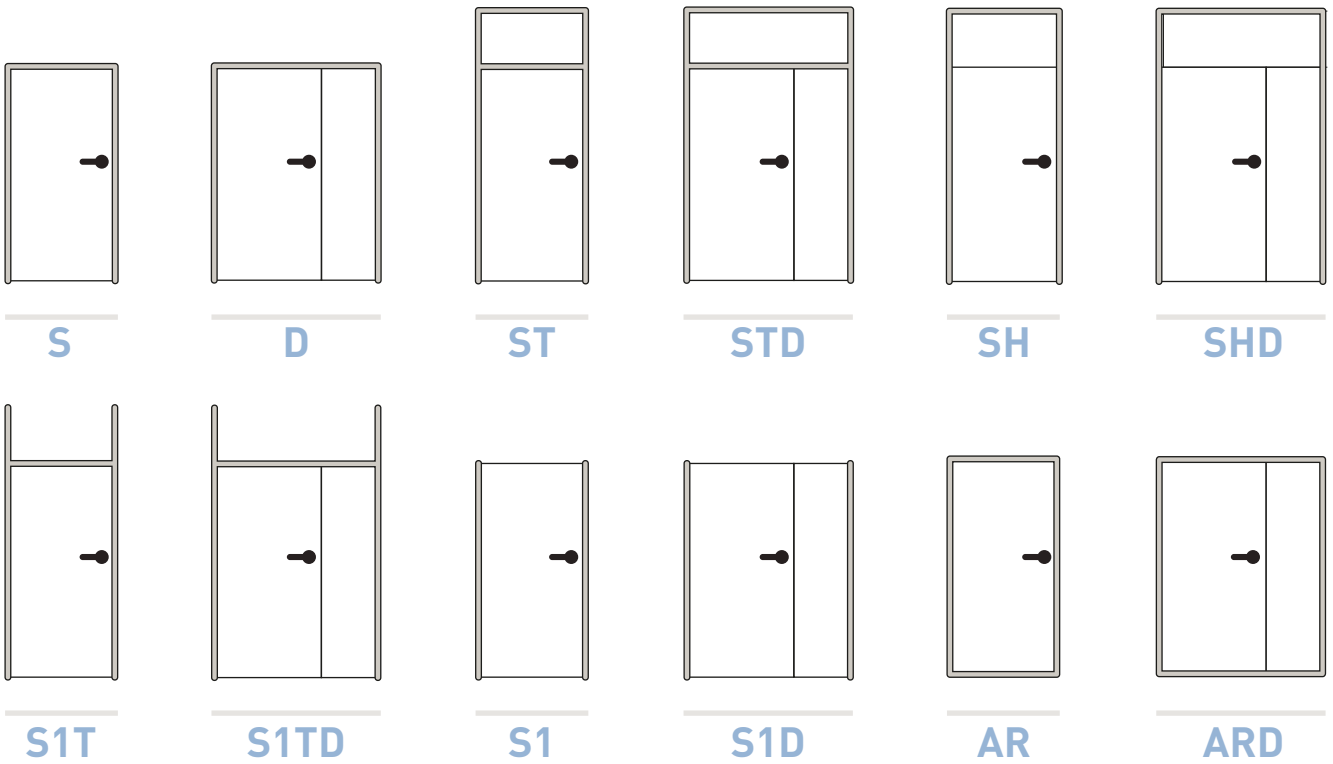

sliding

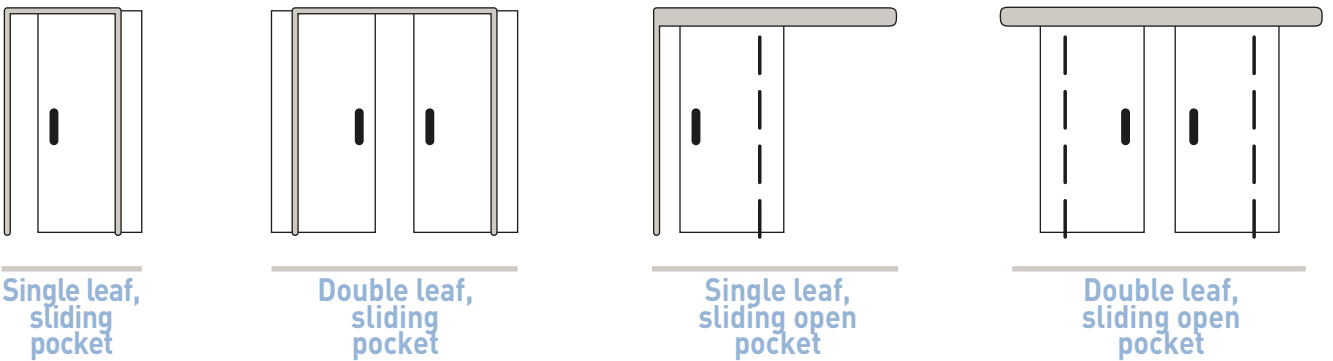

INSTALLATION AFTER WALL CONSTRUCTION

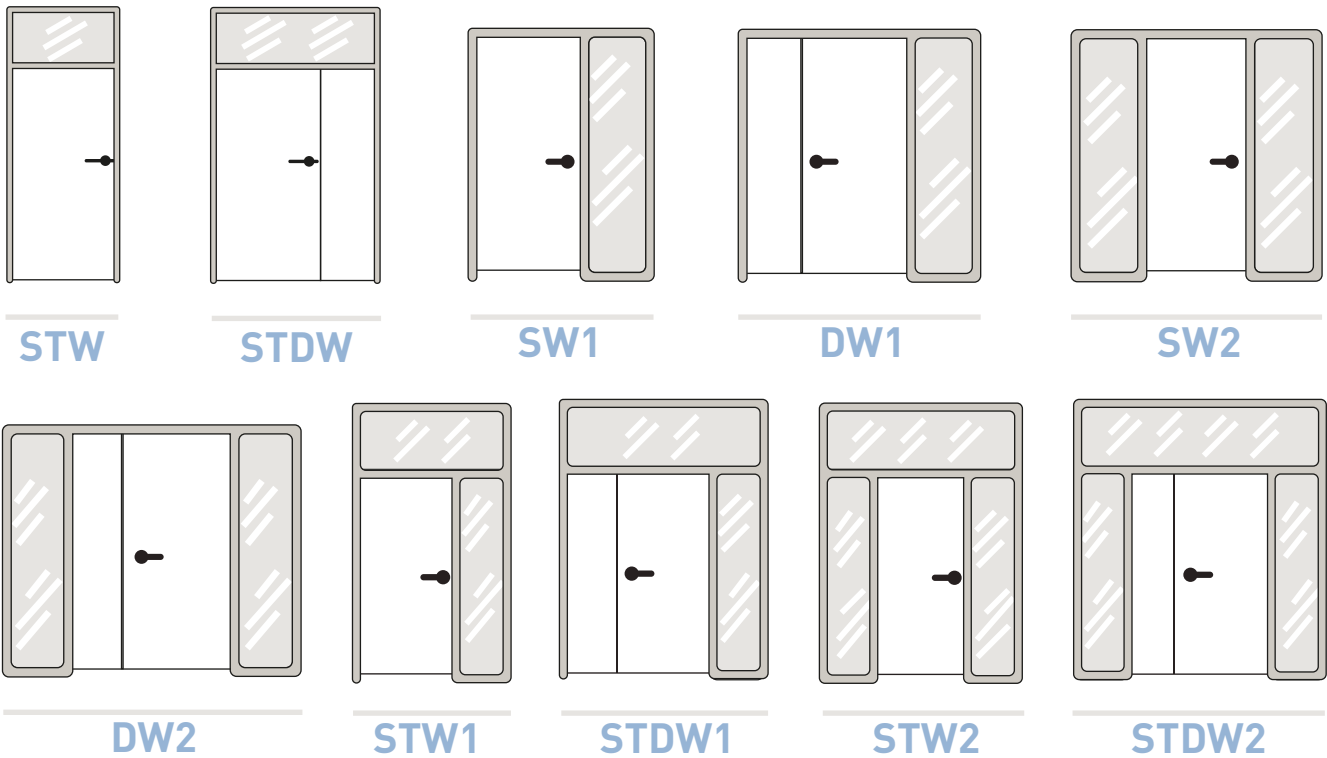

allows intermediate rails to be added

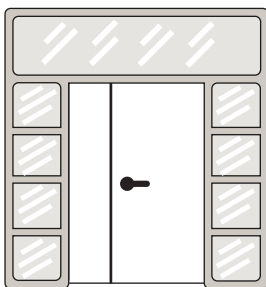

Example of horizontal rails

TYPE G

G1 / G2 / G3

G STANDARD

profiles

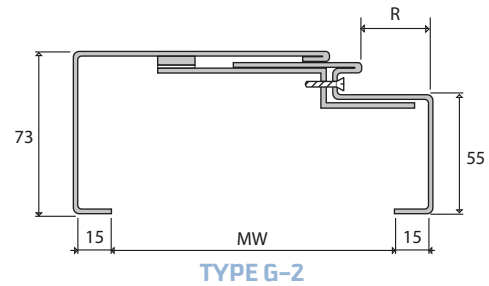
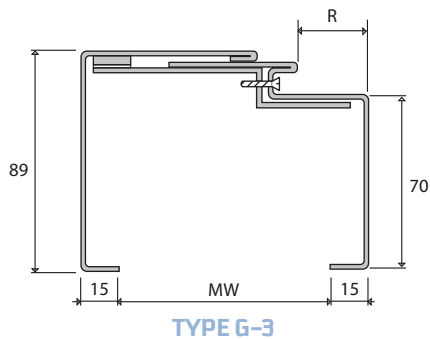
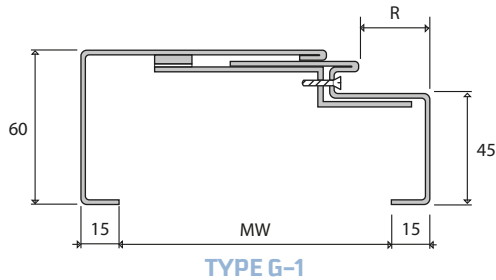

R: 35, 40, 45, 50 mm

* **Structural opening**

MW: Final thickness of finished wall 8, 9, 10, 11, 12, 13, 14, 15, 16, 17, 18, 19, 20, 21, 22, 23, 24 cm

section



specifications

Characteristics: Two piece telescopic frame.

Application: Brick and drywall.

Mounting system: Following construction of the walls. **Knock Down System®**.

Materials: 1,5 mm galvanised steel and 1,2 mm stainless steel.

Types of frames: All (see pages 28-29).

Finishes: Pre-painted galvanised steel, matt stainless steel (with protective film) or RAL lacquer.

Hardware: All

Measurements of the structural opening for G frame
Width of leaf + 6cm / Height of the leaf + 3cm.
 Does not require pre-frame though G2 and G3 can cover this if required.

TYPE G

GDEKOR

DEKOR

profiles

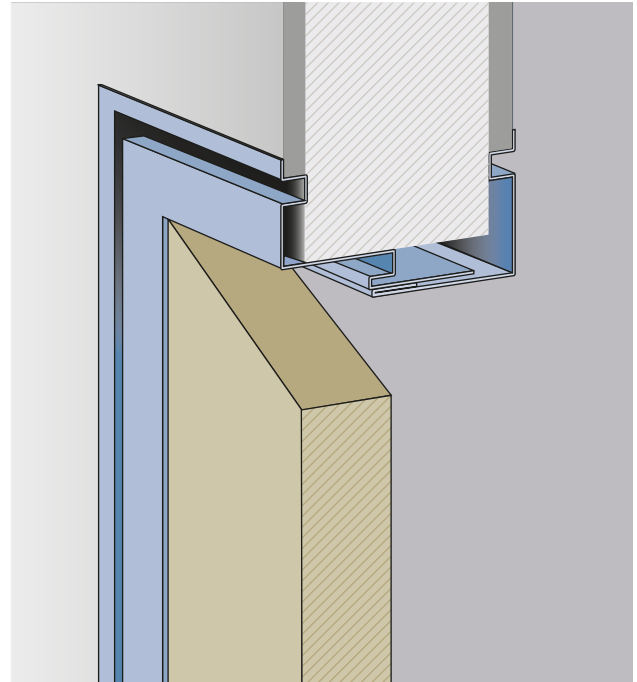
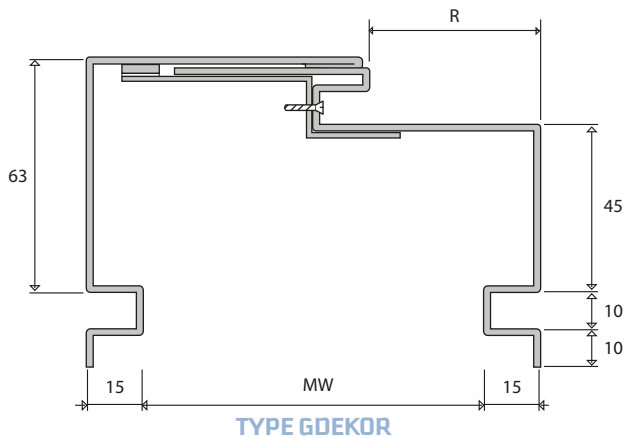

R: 35, 40, 45, 50 mm

MW: Final thickness of finished wall 8, 9, 10, 11, 12, 13, 14, 15, 16, 17, 18, 19, 20, 21, 22, 23, 24 cm

section



specifications

Characteristics: Two piece telescopic frame with a "U" border.

Application: Brick and drywall.

Mounting system: Following construction of the walls. **Knock Down System®.**

Materials: 1,5 mm galvanised steel and 1,2 mm stainless steel.

Types of frames: All (see pages 28-29).

Finishes: Pre-painted galvanised steel, matt stainless steel (with protective film) or RAL lacquer.

Hardware: All

Measurements of the structural opening for G frame
Width of leaf + 6cm / Height of the leaf + 3cm.
Does not require pre-frame though G2 and G3 can cover this if required.

TYPE G

G7

2DEC

profiles

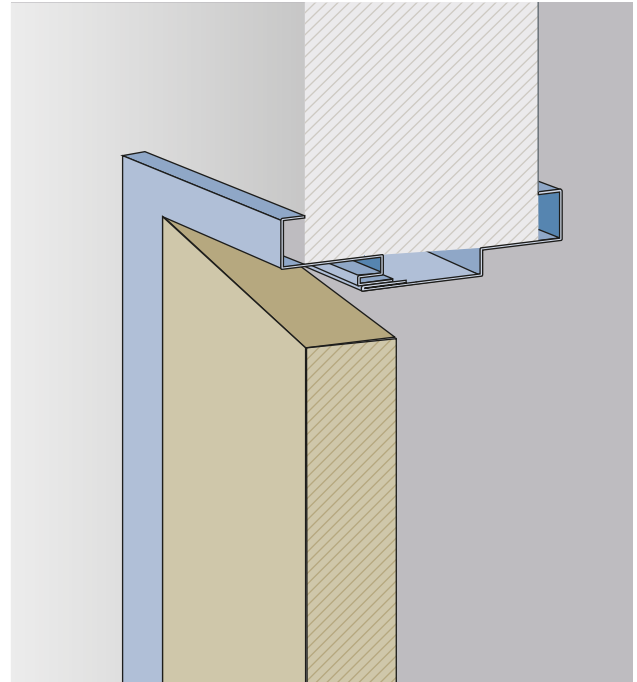
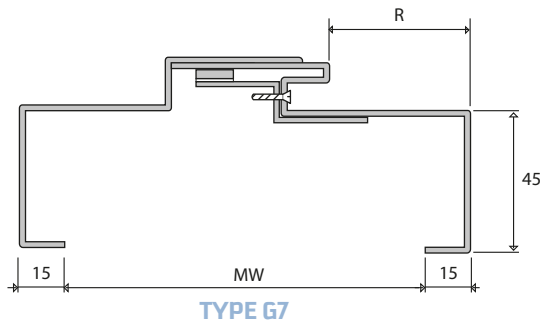

R: 35, 40, 45, 50 mm

MW: Final thickness of finished wall 8, 9, 10, 11, 12, 13, 14, 15, 16, 17, 18, 19, 20, 21, 22, 23, 24 cm

section



specifications

Characteristics: Two piece telescopic frame.

Application: Brick and drywall.

Mounting system: Following construction of the walls. **Knock Down System®.**

Materials: 1,5 mm galvanised steel and 1,2 mm stainless steel.

Types of frames: All (see pages 28-29).

Finishes: Pre-painted galvanised steel, matt stainless steel (with protective film) or RAL lacquer.

Hardware: All

Measurements of the structural opening for G frame
Width of leaf + 6cm / Height of the leaf + 3cm.
Does not require pre-frame though G2 and G3 can cover this if required.

TYPE G

G2G

DOUBLE REBATE

profiles

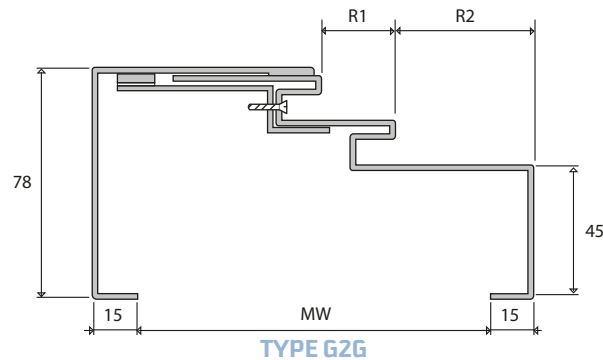

R1: Difference
R2: 35, 40, 45, 50 mm

MW: Final thickness of finished wall 8, 9, 10, 11, 12, 13, 14, 15, 16, 17, 18, 19, 20, 21, 22, 23, 24 cm

section



specifications

Characteristics: Two piece telescopic frame.

Application: Brick and drywall. Recommended for **sound-proofing**.

Mounting system: Following construction of the walls. **Knock Down System®**.

Materials: 1,5 mm galvanised steel and 1,2 mm stainless steel.

Types of frames: All (see pages 28-29).

Finishes: Pre-painted galvanised steel, matt stainless steel (with protective film) or RAL lacquer.

Hardware: All

Measurements of the structural opening for G frame
Width of leaf + 6cm / Height of the leaf + 3cm.
Does not require pre-frame though G2 and G3 can cover this if required.

TYPE G

GH

TYPE H

profile

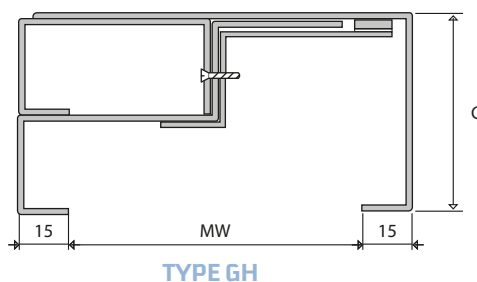

C: 30, 40, 50

MW: Final thickness of finished wall 8, 9, 10, 11, 12, 13, 14, 15, 16, 17, 18, 19, 20, 21, 22, 23, 24 cm

section



specifications

Characteristics: Two piece telescopic frame. Recommended for use in transit areas without doors, or open pocket sliding doors.

Application: Brick and drywall.

Mounting system: Following construction of the walls. **Knock Down System®**.

Materials: 1,5 mm galvanised steel and 1,2 mm stainless steel.

Types of frames: All (see pages 28-29).

Finishes: Pre-painted galvanised steel, matt stainless steel (with protective film) or RAL lacquer.

Hardware: All

Measurements of the structural opening for G frame
Width of leaf + 6cm / Height of the leaf + 3cm.
Does not require pre-frame though G2 and G3 can cover this if required.

TYPE G GVAIVÉN

SWINGING

profile

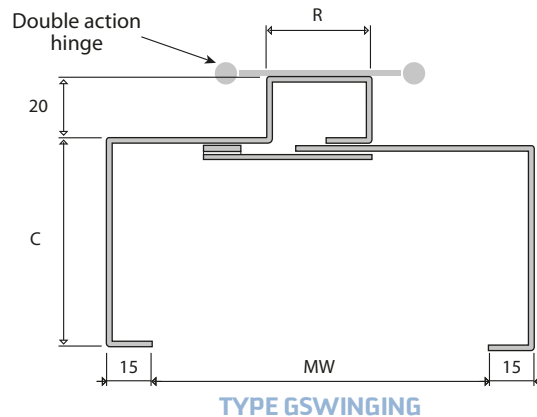

R: 35, 40, 45 mm

C: 30, 40, 50 mm

MW: Thickness of finished wall 8, 9, 10, 11, 12, 13, 14, 15, 16, 17, 18, 19, 20, 21, 22, 23, 24 cm

section



specifications

Characteristics: Two piece telescopic frame.

Application: For swing doors. Does not include hinges.

Mounting system: Following construction of the walls. **Knock Down System®.**

Materials: 1,5 mm galvanised steel and 1,2 mm stainless steel.

Types of frames: All (see pages 28-29).

Finishes: Pre-painted galvanised steel, matt stainless steel (with protective film) or RAL lacquer.

Hardware: Double action hinges only. Not included.

Measurements of the structural opening for G frame
Width of leaf + 6cm / Height of the leaf + 3cm.
Does not require pre-frame though G2 and G3 can cover this if required.

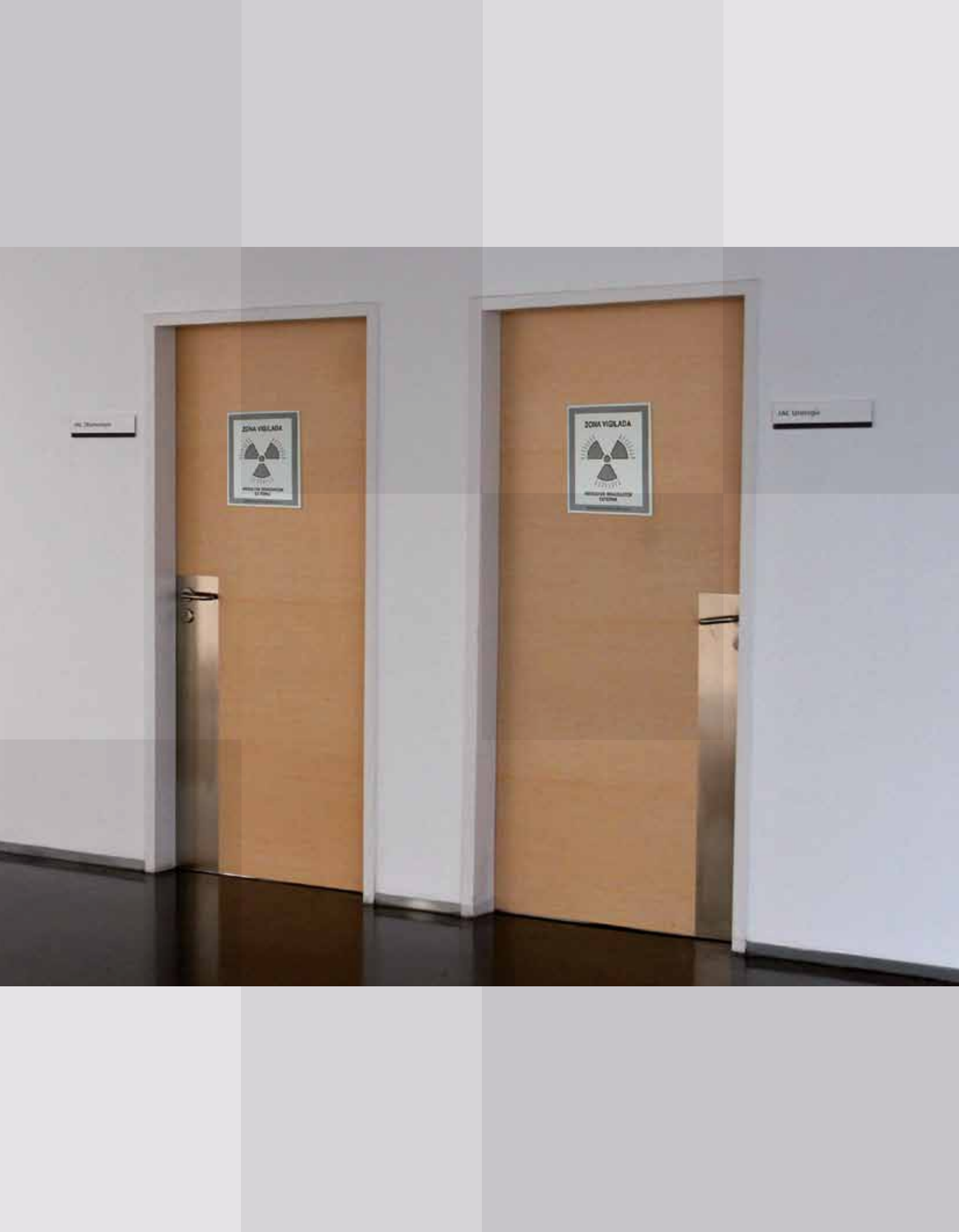

№ 200000000



№ 100000000





special steel

We know that every environment requires a type of frame; lightning zones, flush panelling, fire resistance, soundproofing ... For this reason at Soleco we create a tailor-made solution for every case.



SPECIAL Ei

FIRE RESISTANT Ei

profile

Fixed directly to the wall (F)

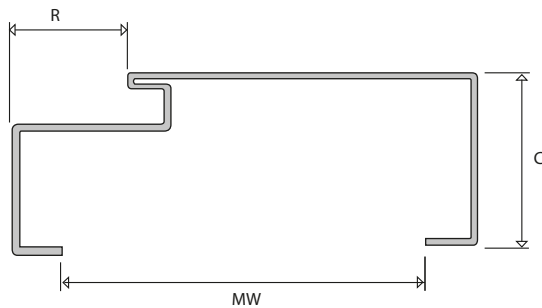

TYPE F1/F2/F3

Telescopic mounted after walling (G)

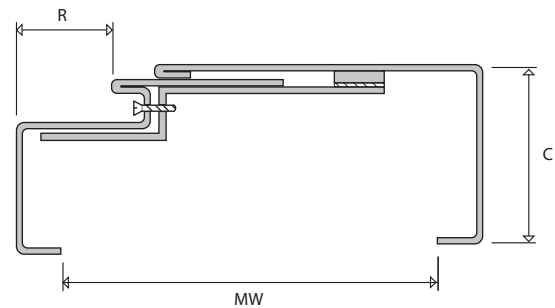

TYPE G1/G2/G3

R/MW/C: According to trials.

R/MW/C: According to trials.

list Ei

standards Ei

Ei 30
Ei 45
Ei 60

standards Ei + acoustic

Ei 30;32 Decibels
Ei 45;42 Decibels
Ei 60;42 Decibels

specifications

Characteristics: Single fixed frame or two-piece telescopic frame. Fire resistant in compliance with Ei regulations

Application: In required areas.

Mounting system: Both before and after construction of the walls. **Knock Down System®.**

Materials: 1,5 mm galvanised steel and 1,2 mm stainless steel.

Types of frames: Please consult us.

Finishes: Pre-painted galvanised steel, matt stainless steel (with protective film) or RAL lacquer.

Hardware: Soleco standard hinge.

SPECIAL EMP

LEAD LINED RADIATION PROOF

profile

Fixed directly to the wall (F)



Telescopic mounted after walling (G)

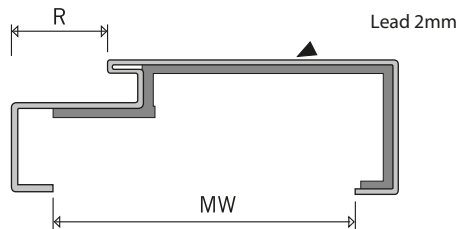

TYPE F1/F2/F3

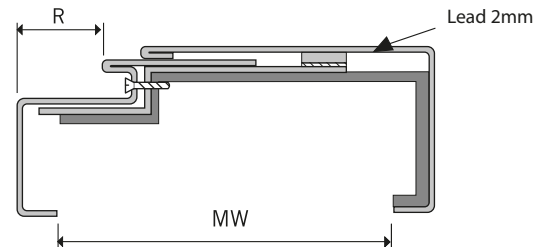

TYPE G1/G2/G3

R: 35, 40, 45 mm

MW: Thickness of finished wall 8, 9, 10, 11, 12, 13, 14, 15, 16, 17, 18, 19, 20, 21, 22, 23, 24 cm

section



TYPE F EMP



TYPE G EMP

specifications

Characteristics: Fixed or telescopic frame prepared to resist X-rays.

Application: In areas where X-rays are used.

Mounting system: Both before and after construction of the walls. **Knock Down System®.**

Materials: 1,5 mm galvanised steel and 1,2 mm stainless steel lined with lead. Standard thickness of lead lining is 2mm.

Types of frames: Please consult us.

Finishes: Pre-painted galvanised steel, matt stainless steel (with protective film) or RAL lacquer.

Hardware: Soleco standard hinge.

SPECIAL ECFT

SLIDING OPEN POCKET

profiles

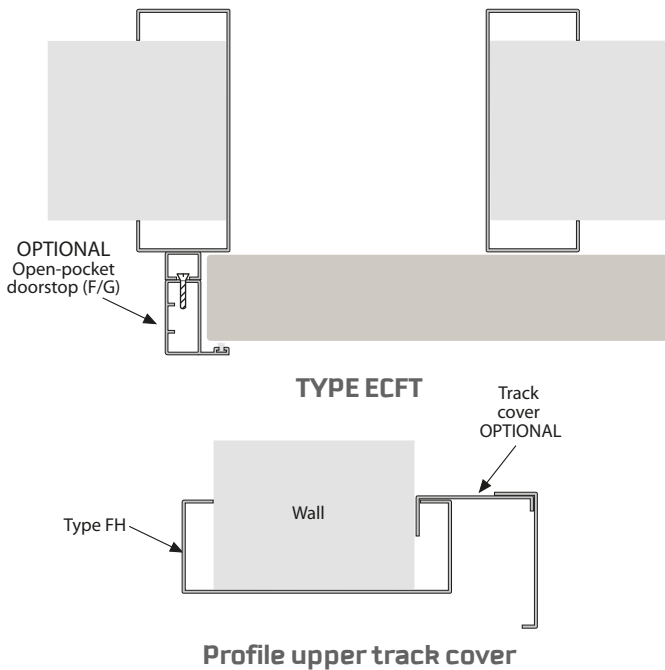

upper track cover



specifications

Characteristics: Frame for open pocket sliding doors.

Application: Brick walls and drywalls.

Mounting system: During wall construction (F), after completion of walls (G)

Materials: 1,5 mm galvanised steel and 1,2 mm stainless steel.

Types of frames: Types FH and GH

Finishes: Pre-painted (F) or RAL lacquered (G).

Hardware: Upper track not supplied. Doorstop and track cover are optional.

SPECIAL ECET

SLIDING POCKET

profiles

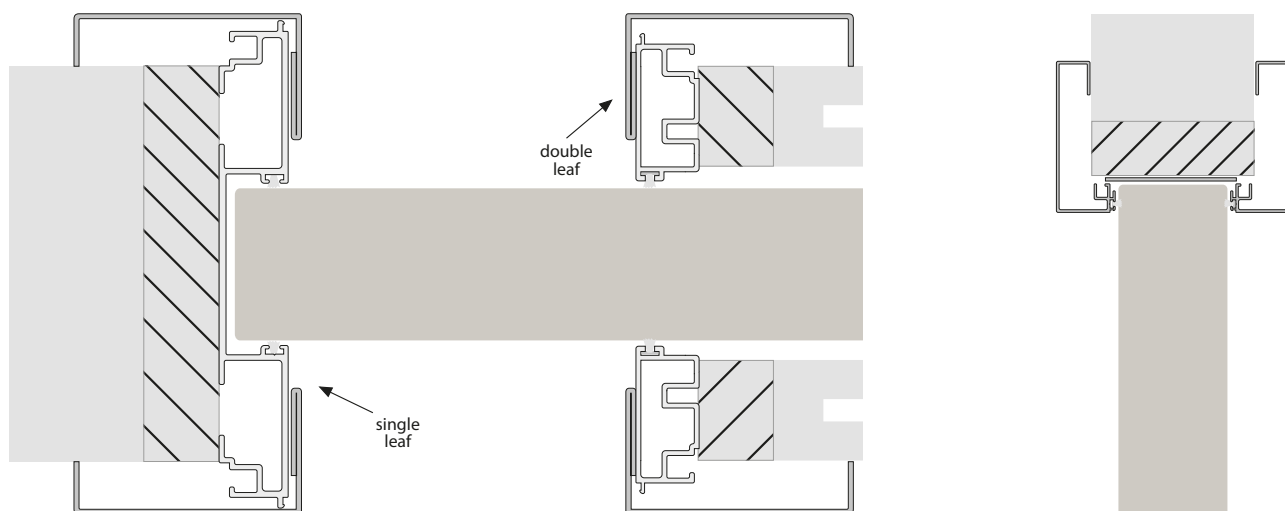

TYPE ECET

Profile Upper track
(valance)

finish



specifications

Characteristics: Telescopic frame for pocket sliding doors.

Application: Any type of box for sliding doors.

Mounting system: After completion of the walls.

Materials: 1,5 mm galvanised steel and 1,2 mm stainless steel. Aluminium interior.

Types of frames: Single or double leaf (see illustration)

Finishes: Pre-painted or RAL lacquered.

Hardware: Any type of box, both for drywall or plasterboard.

SPECIAL EN-INT

FLUSH-WITH-WALL inward opening

profile

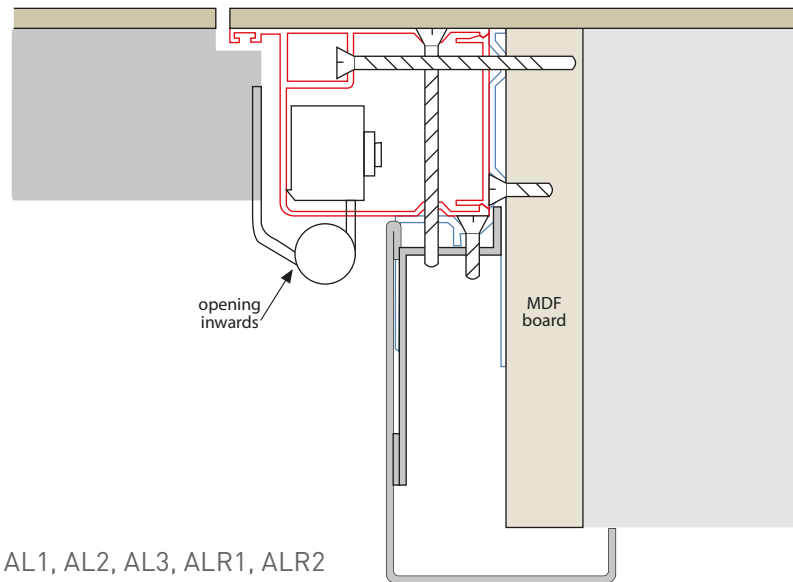

* Permits mounting with AL1, AL2, AL3, ALR1, ALR2 and ALR3.

finish



specifications

Characteristics: special frame designed for flush-with-wall doors.

Application: Brick walls and drywall.

Mounting system: After completion of the walls. It is advisable to fix to an MDF pre-frame

Materials: 1,5 mm galvanised steel and 1,2 mm stainless steel. Aluminium interior. Flashing made of galvanised or stainless steel.

Types of frames: Specific for paneling.

Finishes: Pre-painted or RAL lacquered.

Hardware: Standard hinge for doors with 5,5 cm thickness. Special hinge for flush mounted doors of 4,5 cm thickness.

SPECIAL EN-EXT

FLUSH-WITH-WALL outward opening

profile

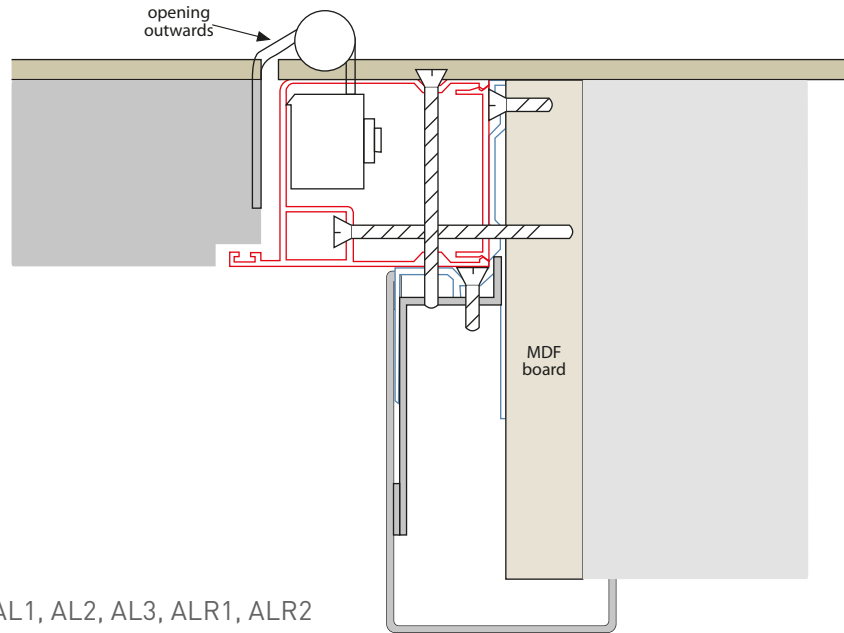

* Permits mounting with AL1, AL2, AL3, ALR1, ALR2 and ALR3.

finish



specifications

Characteristics: special frame designed for flush-with-wall doors.

Application: Brick walls and drywall.

Mounting system: After completion of the walls. It is advisable to fix to an MDF pre-frame

Materials: 1,5 mm galvanised steel and 1,2 mm stainless steel. Aluminium interior. Flashing made of galvanised or stainless steel.

Types of frames: Specific for paneling.

Finishes: Pre-painted or RAL lacquered.

Hardware: Standard hinge for doors with 5,5 cm thickness. Special hinge for flush mounted doors of 4,5 cm thickness.

NOTE: Possibility of using concealed hinge with 10 mm displacement.

SPECIAL

30dB

30 DECIBEL

profiles

Fixed direct to wall(F)



Telescopic mounted after walling (G)

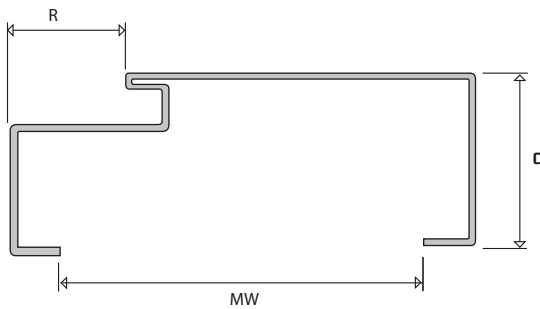

TYPE F1/F2/F3

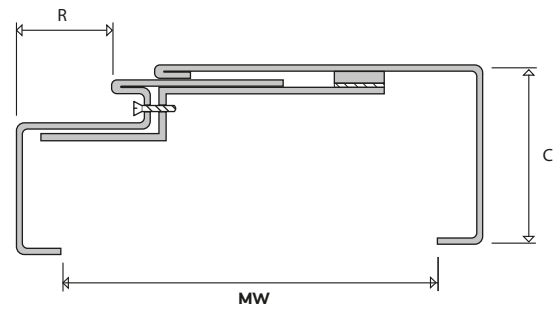

TYPE G1/G2/G3

specifications

Characteristics: Frame of one or two pieces with C.T.E (Building Technical Code) certification.

Application: Brick walls and drywall.

Mounting system: Before and after completion of the walls. **Knock Down System®**.

Materials: 1,5 mm galvanised steel and 1,2 mm stainless steel.

Types of frames: S, D, ST, STD, STW1, STDW.

Finishes: Pre-painted galvanised steel, matt stainless steel (with protective film) or RAL lacquered.

Hardware: Standard Soleco hinge.

NOTE: Consult about approved doors.







stainless steel

Every type of solution, adaptable to any type of Soleco frame. We offer endless possibilities – if you need it we will make it. Our aim is to make things easy for you.



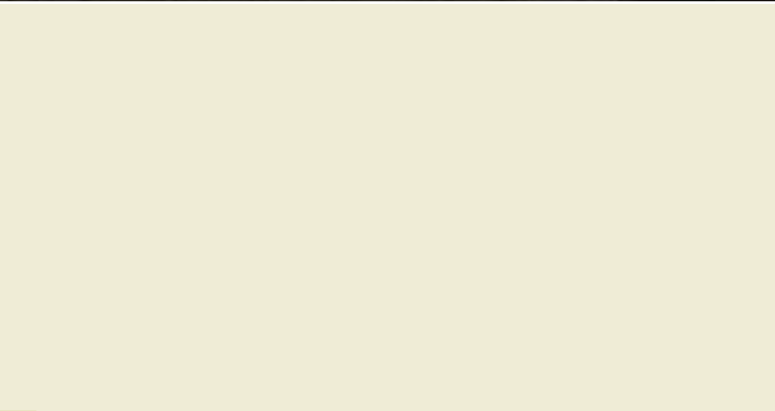
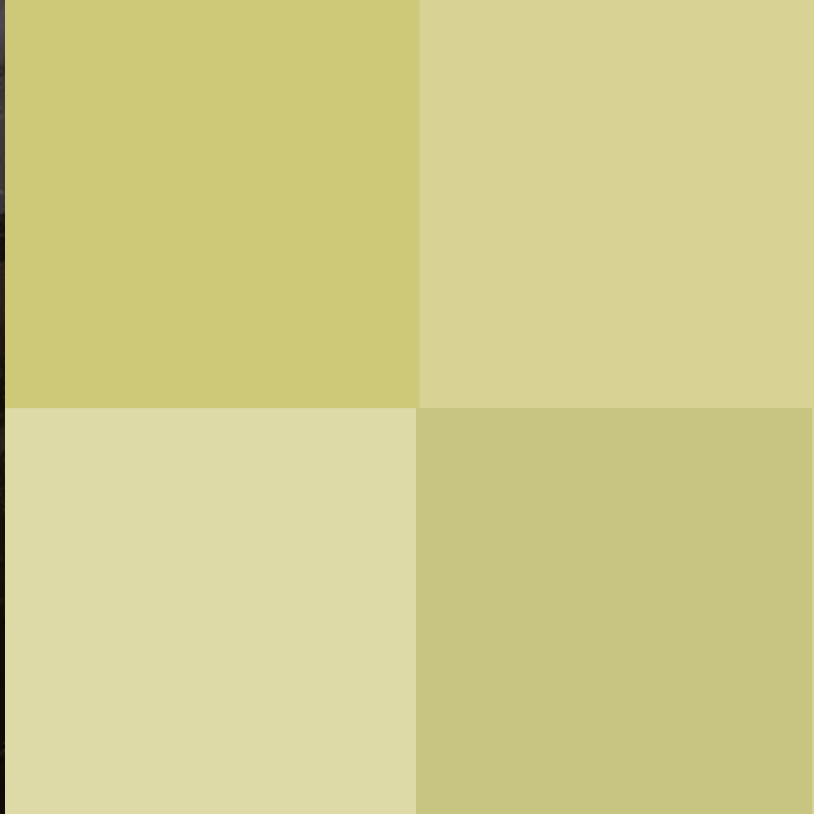



STAINLESS

EVERY TYPE OF FRAME

profile

Fixed direct to the wall (F)

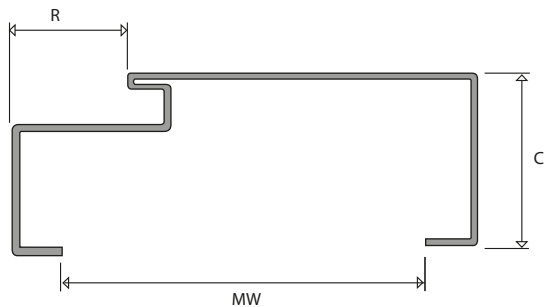

TYPE F1/F2/F3

Telescopic after partition walling (G)

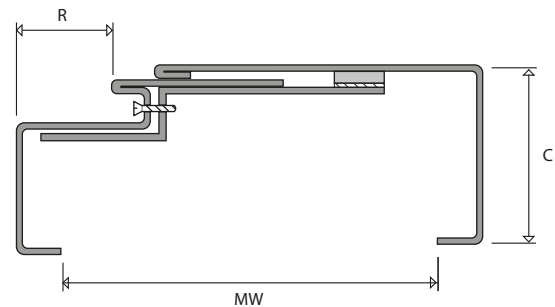

TYPE G1/G2/G3

R: 35, 40, 45 mm

C: 30, 40, 50 mm

MW: Thickness of finished wall 8, 9, 10, 11, 12, 13, 14, 15, 16, 17, 18, 19, 20, 21, 22, 23, 24 cm

every type of frame available

For special solutions in stainless steel, Soleco offers the possibility of making any type of frame and mounting (except F-DEKOR) in this material, although our specialists recommend the telescopic models that can be fitted once building has finished.

specifications

Characteristics: Fixed frame or telescopic frames in two pieces. Fire resistant as per Ei standards.

Application: Where required.

Mounting system: Before and after completion of partition walls. **Knock Down System®.**

Materials: 1,5 mm galvanised steel and 1,2 mm stainless steel

Types of frames: Please consult.

Finishes: Pre-painted galvanised steel, matt stainless steel (with protective film) or RAL lacquered.

Hardware: Standard Soleco hinge.

NOTE: Stainless steel, standard AISI 304. Can also be made in AISI 316.

STAINLESS TRANSOM SOLUTIONS

profiles

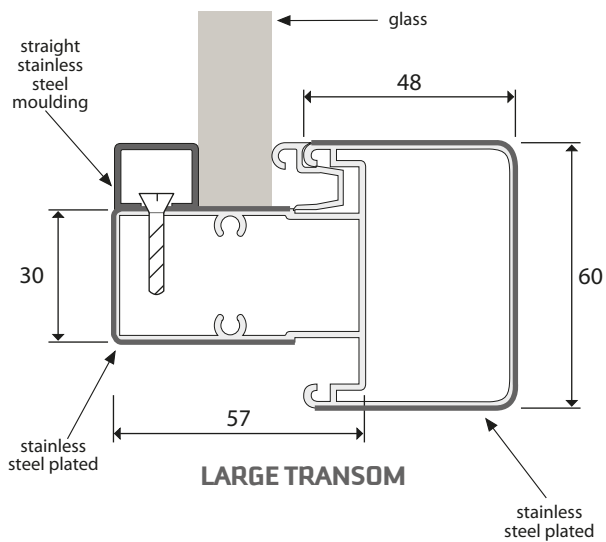

* Mounting possible with large, small and lower transom.

section

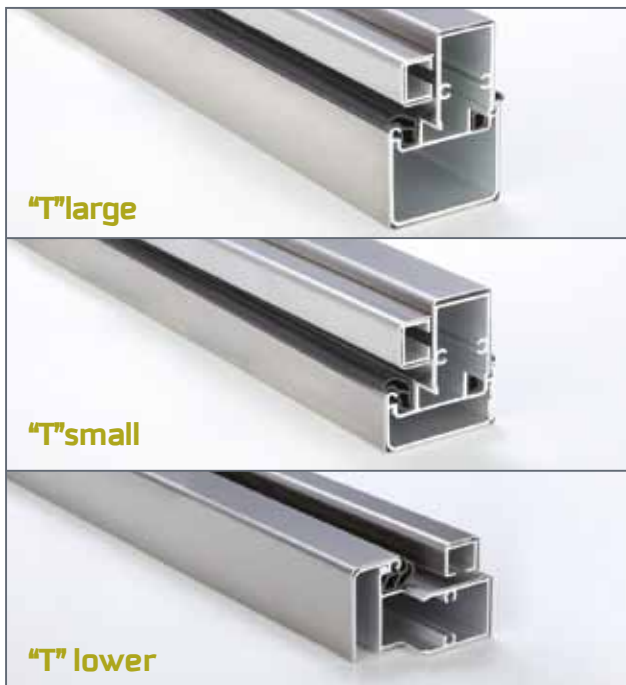

specifications

Characteristics: Frame of 1(F) or two (G) pieces of stainless steel.

Application: Doors with a transom.

Mounting system: Knock Down System®.

Materials: Stainless steel AISI 340.

Types of frames: All (see pages 16-17).

Finishes: Matt stainless steel (with protective film).

Hardware: Standard hinge, return hinge and concealed hinge.

STAINLESS CFT-INOX

SLIDING OPEN POCKET

profile

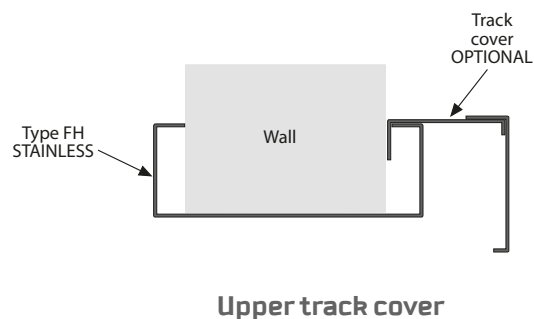
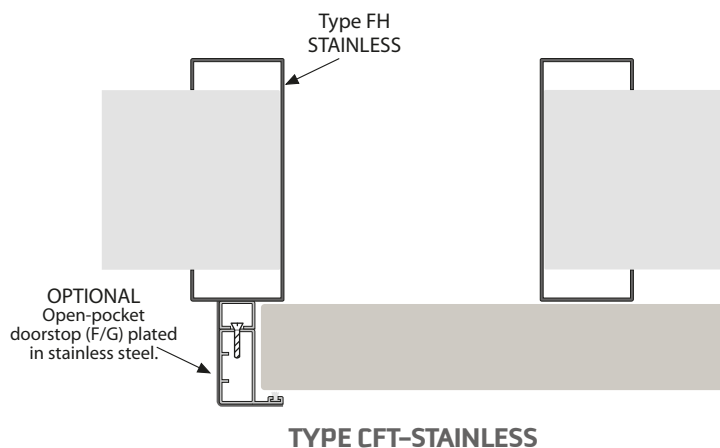

example stainless steel plating



specifications

Characteristics: Frame of 1 (F) or 2 (G) pieces of stainless steel.

Application: Open pocket sliding doors.

Mounting system: Knock Down System®.

Materials: Stainless steel AISI 340.

Types of frames: All (see pages 16-17).

Finishes: Matt (with protective film).

Hardware: Upper track not supplied. Doorstop and track cover are optional.

profiles

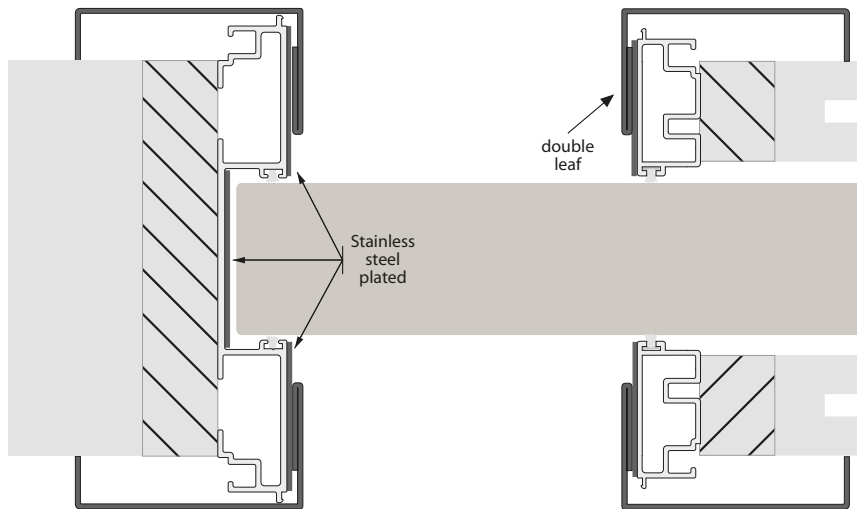

TYPE ECET

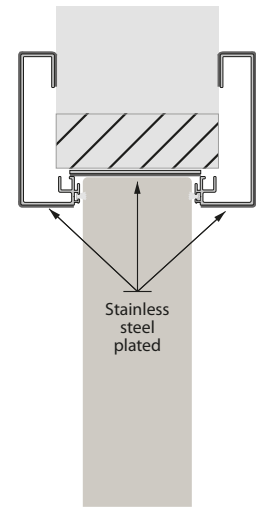

Profile Upper track
(valance)

specifications

Characteristics: Frame of 1 (F) or 2 (G) pieces of stainless steel.

Application: Pocket sliding doors.

Mounting system: Knock Down System®.

Materials: Stainless steel AISI 340.

Types of frames: All (see pages 16-17).

Finishes: Matt (with protective film).

Hardware: Any type of box, both for drywall or plasterboard.



Steel Assembly instructions

Soleco presents every one of their products in an individual package that is referenced according to its dimensions, the opening direction, wall thickness and plan reference. All the necessary information is included. To assist you with the correct installation there follows a guide explaining the steps required for mounting the frames. Installation varies according to the moment when the partition walls are built.



STEEL FIXED (F)

ASSEMBLY BEFORE PARTITIONING

KNOCK-DOWN SYSTEM®

The frame is put in place during room partitioning, both for brick wall and for drywall. **Profiles F.**

Assembly of the frame

Adjustments to the frame should be made according to the following steps in order to ensure a rapid and trouble-free assembly.

Joining of top rails. Knock-Down System®.

This is a distinctive system patented by Soleco to avoid vertical and horizontal displacement of the frame. Apart from its usefulness, it also provides for easy assembly and storage.



Knock-Down System®

Fixing to the lower part of the "U"

This security system should remain fixed until the frame is being levelled for its final placement. The inside-bottom section of Soleco frames incorporate two fixing brackets that provide adherence to the floor. In this way the opening or closing of the frame is avoided, guaranteeing the desired result.



Fixing brackets



Leveling "U"

Fixing System

Soleco prepares its frames for installation in both brick wall or drywall partitions. This provides greater flexibility for installation and convenience for the customer.



Element for fixing to drywall framing



Element for fixing to brick

STEEL TELESCOPIC (G)

ASSEMBLY AFTER PARTITIONING

Frame is put in place after partitioning is completed. **Profiles G.**

Assembly of the frame

This step is identical to that previously described, the **Knock-Down System®**.

Separation of the two parts of the frame

The parts are separated by removing the fixing screws found in the seal (near hinges).

Fixing of one part of the frame to a face of the wall

Fill with expanding polyurethane foam and then put the other part in place, adjust as required and screw the frames to ensure a perfect fit. This allows for an adjustment in the thickness of the wall of 2 cm.



Measurements of the structural opening for G frame - Width of leaf + 6cm / Height of the leaf + 3cm
Does not require pre-frame though G2 and G3 can cover this if required.

CHARACTERISTICS

- Produced according to DIN standards 18111.
- Galvanised and stainless steel.
- **Thickness of galvanised steel 1,5 mm.** As per DIN 1623 Ust-12, pre-painted, ready to receive industry standard paints and lacquers.
- Knock-Down System®. (removable)
- 3 housings for hinges V8610, permitting the perfect hanging of the door.
- Anchor fittings (three or more in each kit) permitting an adequate union to each type of wall (drywall or brick).
- Housing for the latches protected by a metal box.
- To aid installation, the lower section of each frame is fitted with a "U" for levelling.
- Frame of 1,2 mm matt stainless steel (18.10. AISI 304).
- All lacquers in RAL as per current regulations.

ADVANTAGES

- Manufactured according to European standards.
- Long lasting, low maintenance.
- Perfectly adaptable for schools, rest homes, hospitals, hotels, apartments, offices, sports centres, shopping centres and private homes.
- No pre-frame required.
- Frames are pre-painted with primer and prepared for any kind of finish.
- Anti-corrosion protection.
- Extensible frame in two pieces, types G1, G2 and G3, for installation when works are completed.
- Easy, fast and economical installation.
- Space available permits installation to different joint types – fireproof, soundproof, etc.
- Knock-down system, (removable) easy assembly without screws.
- Soleco package their steel frames to ensure that the product is protected, maintaining it in perfect condition. Each frame together with all of its component parts are individually packed.
- All lacquers in RAL as per current regulations.





aluminium finishes with elegance

Frames in aluminium with as many possibilities as steel. Clean and elegant, allowing for curved or straight finishes. Once more, Soleco offers a multitude of options.

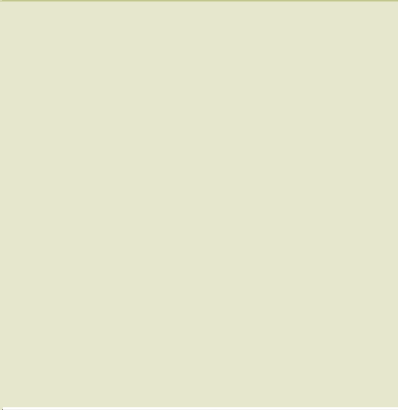
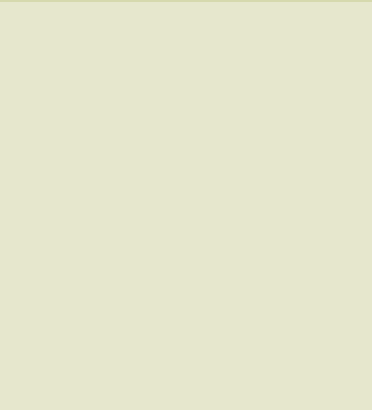
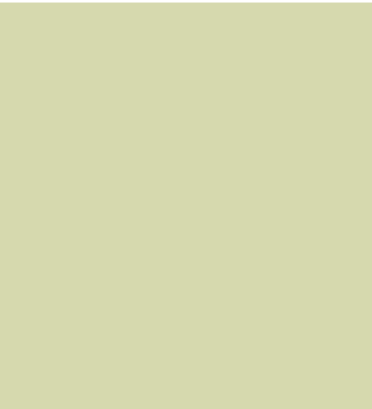



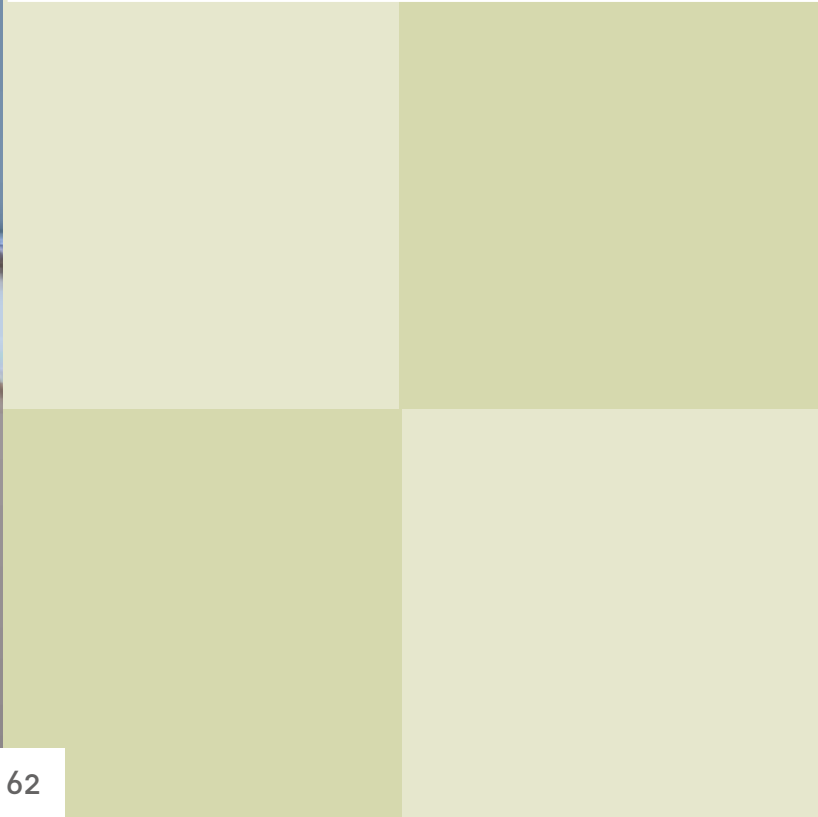
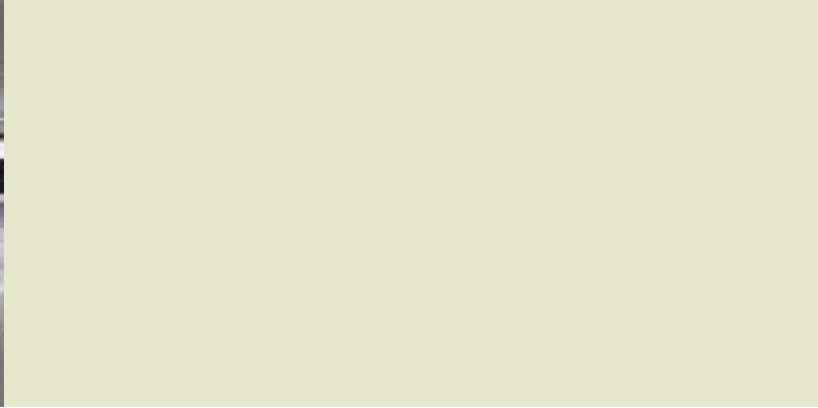

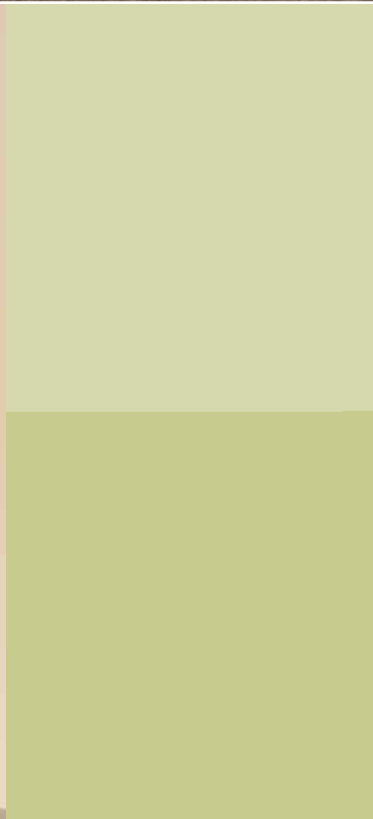
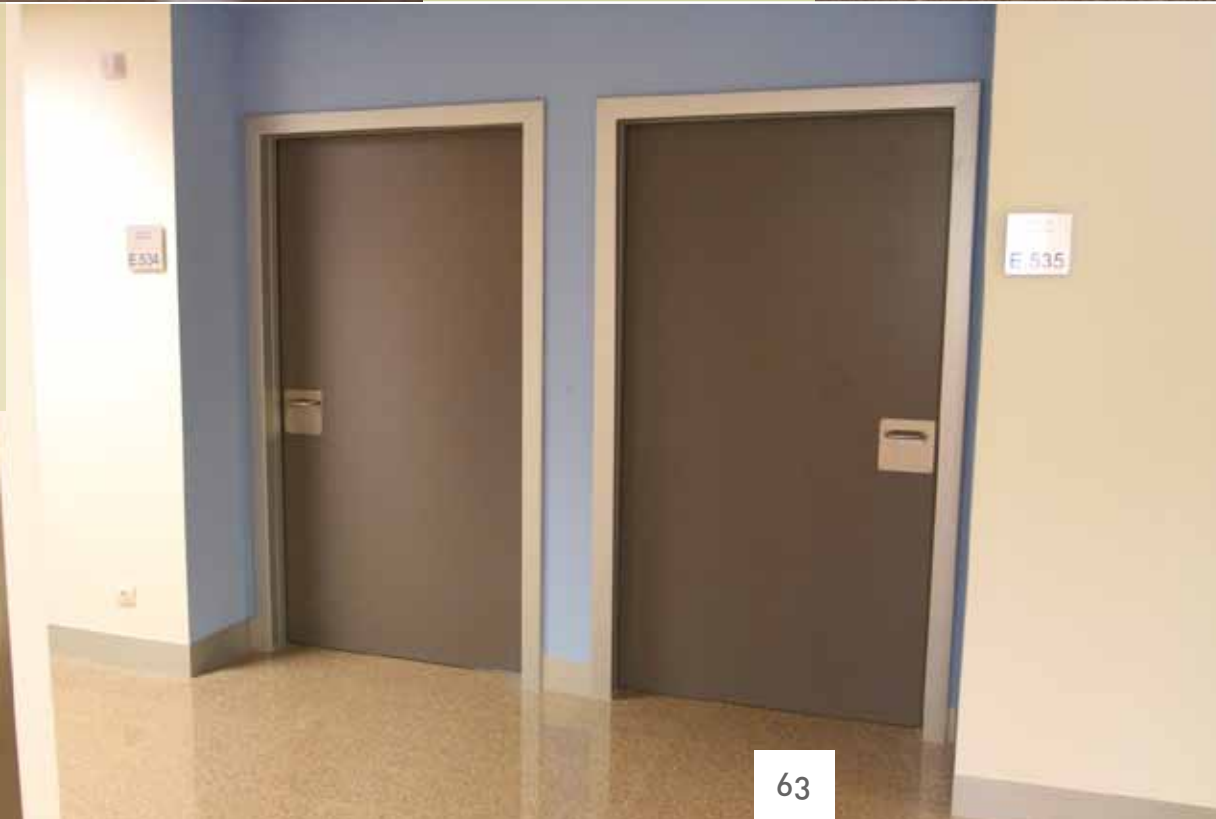
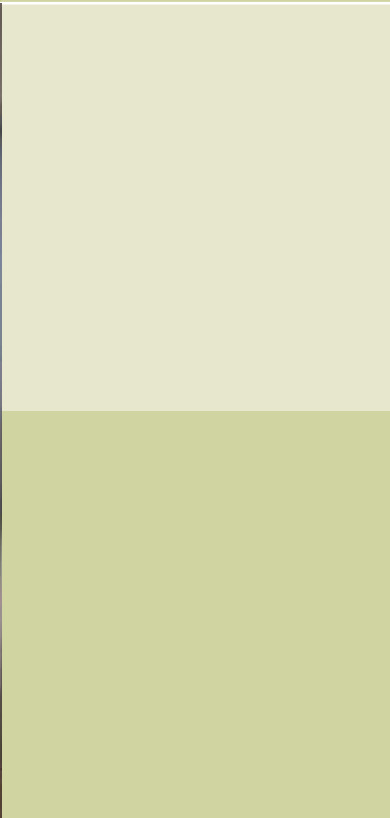

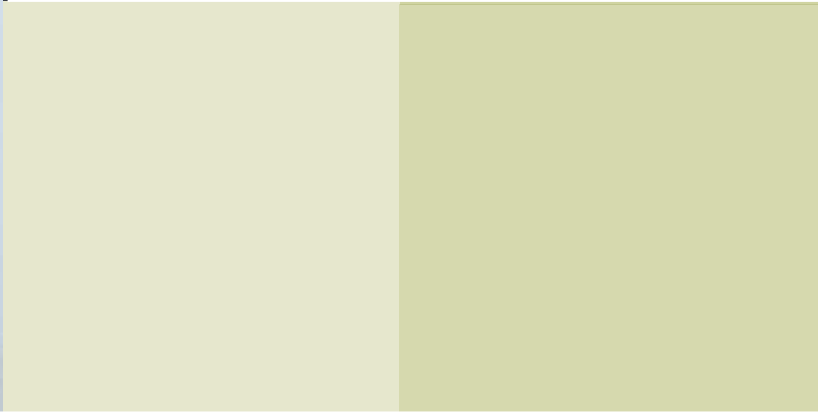
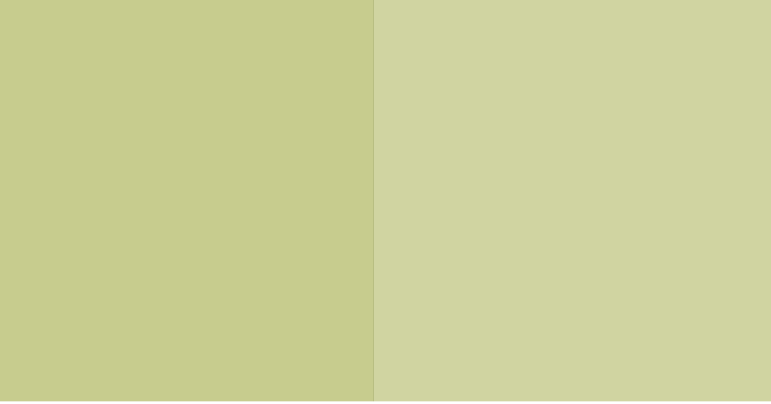

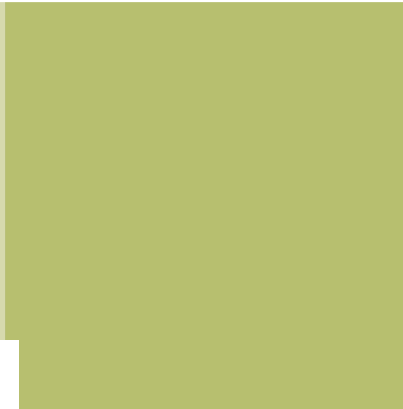
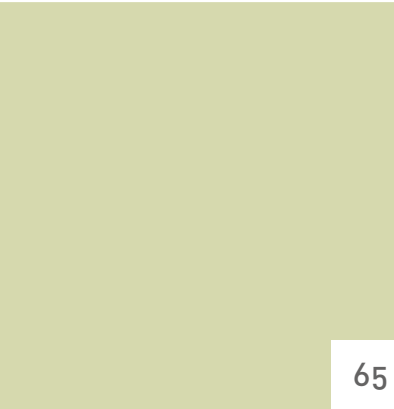
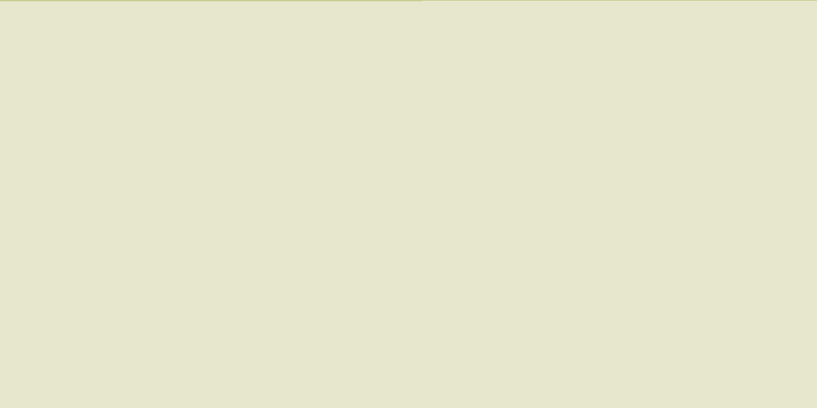

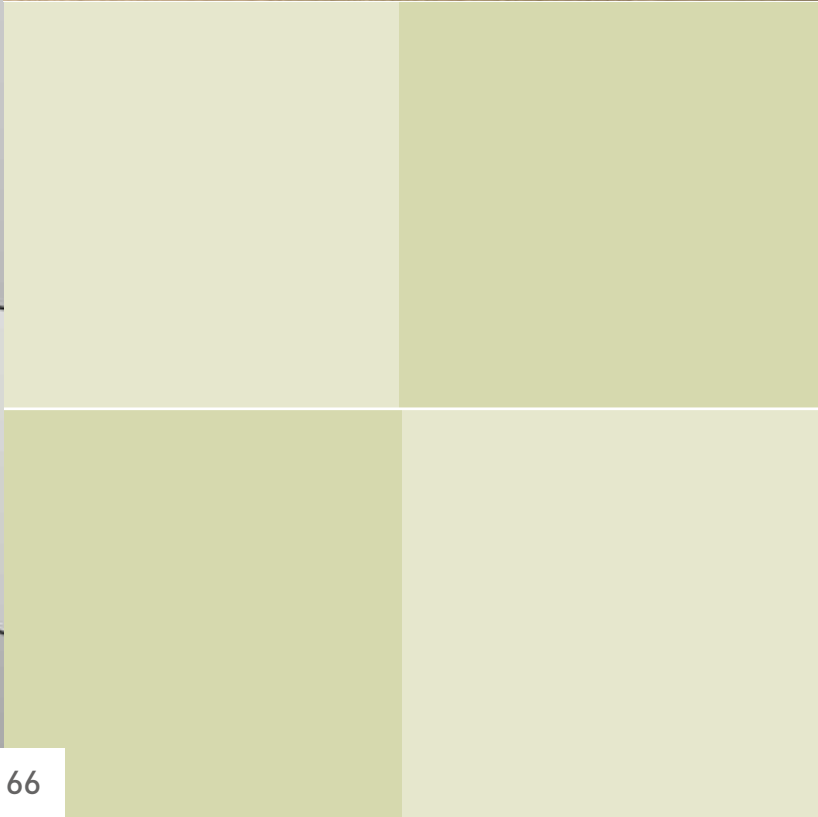
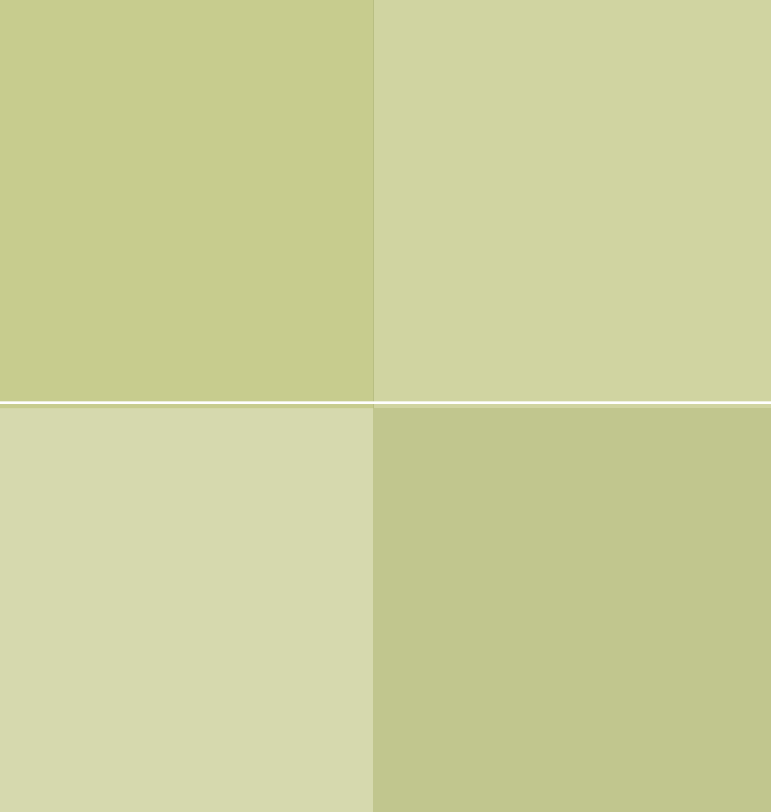

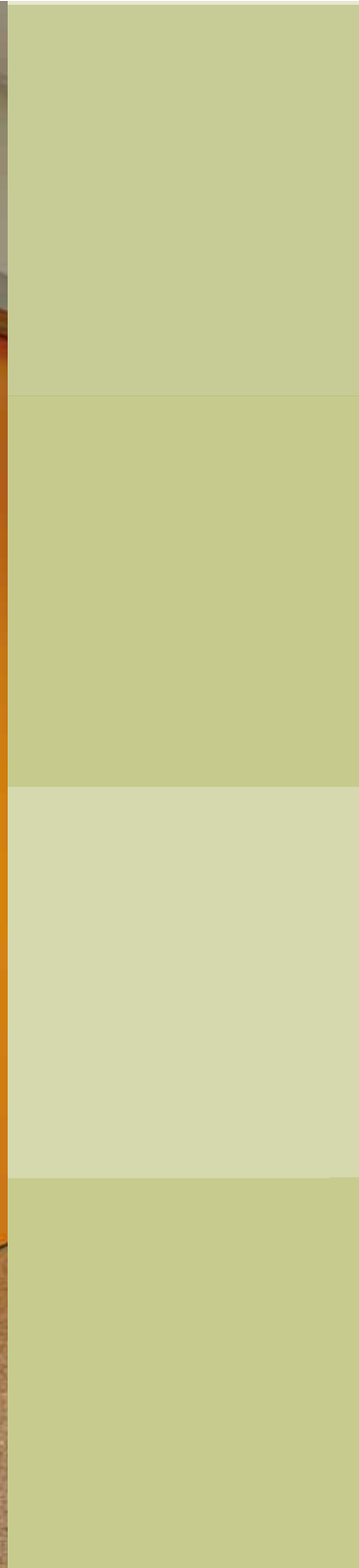

TELESCOPIC ALUMINIUM FRAMES (AL)

types of frames

Two-piece, extensible aluminium profile for fitting after partitioning is completed.

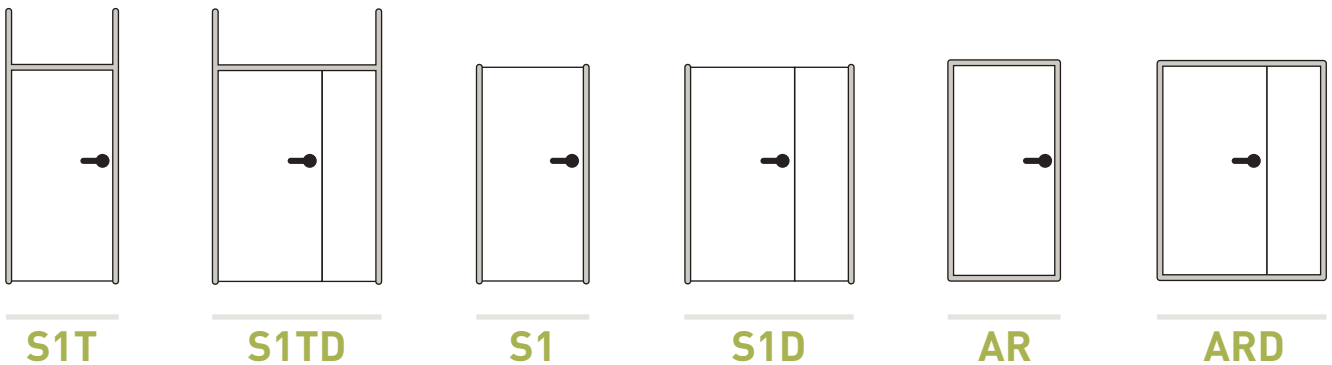
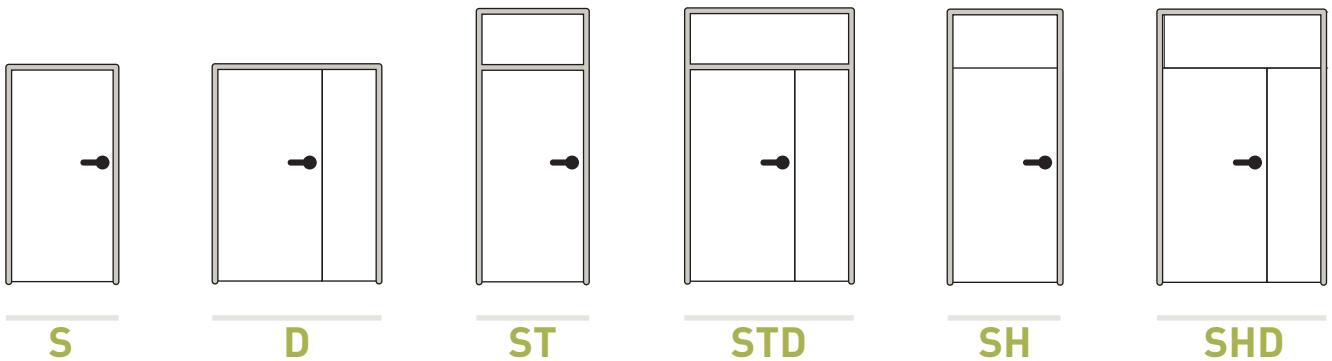

sliding

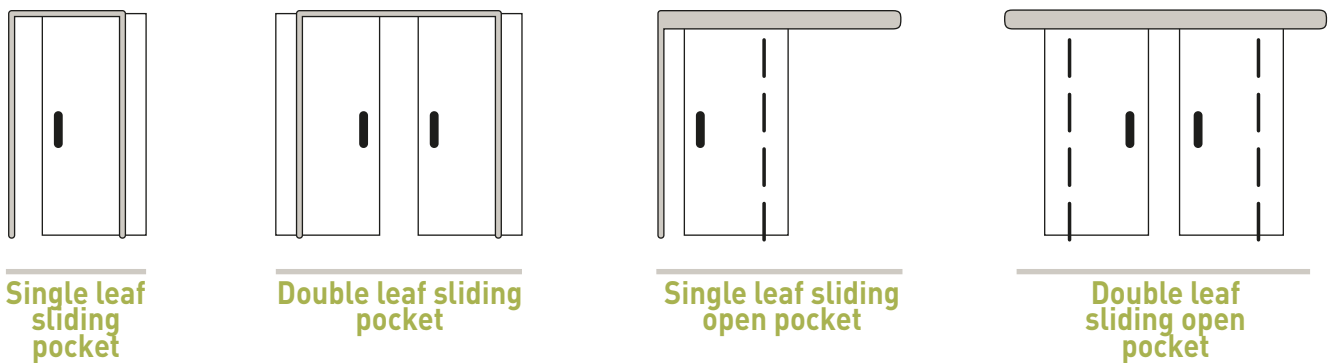

INSTALLATION ONCE INTERIOR PARTITIONING IS COMPLETED

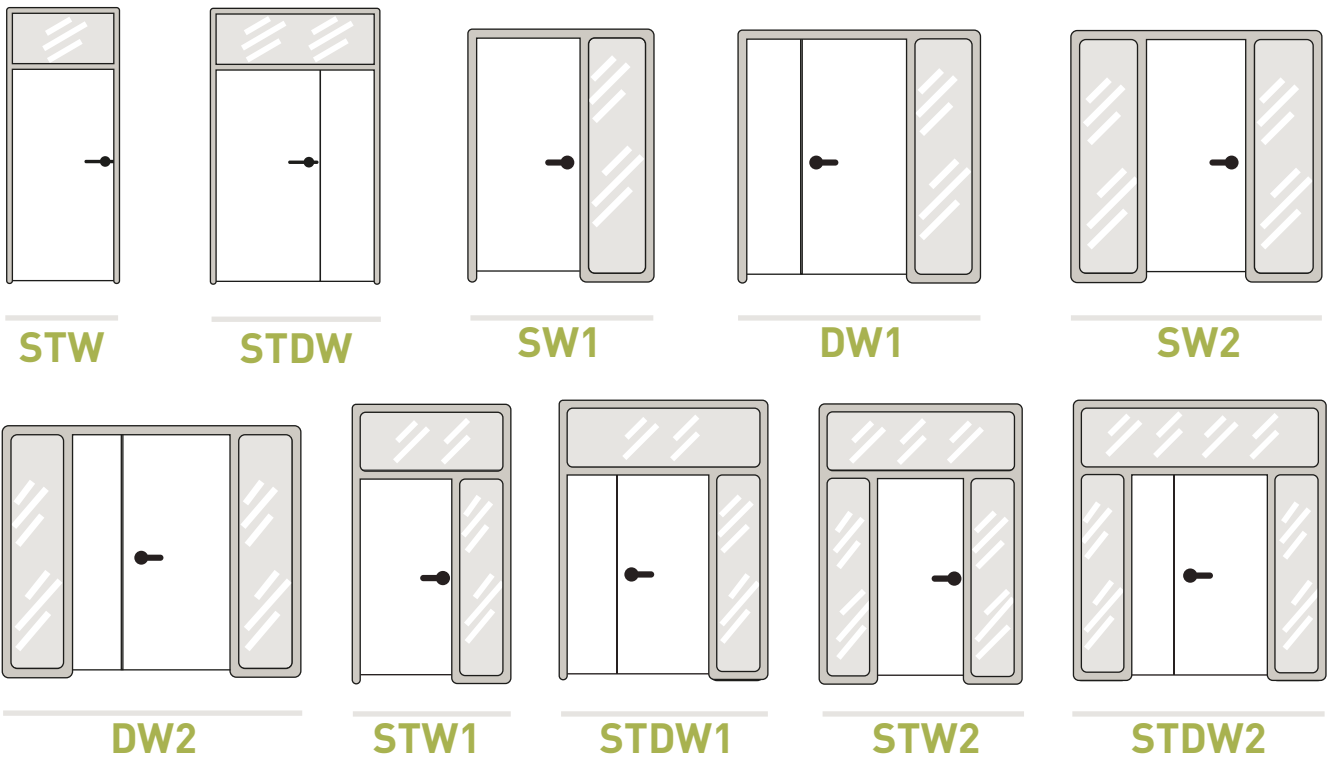

possibility to add intermediate rails

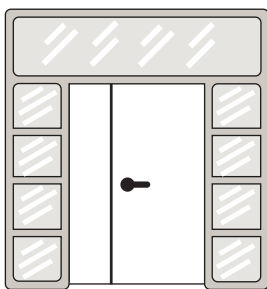

Example of horizontal rails

TYPE AL

AL1 / AL2 / AL3

CURVED ANGLE

profiles

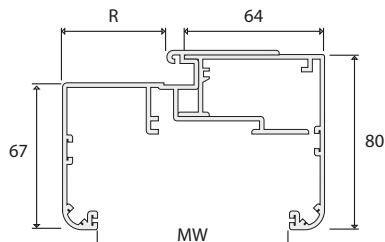

TYPE AL1 (9-11,5 cm)

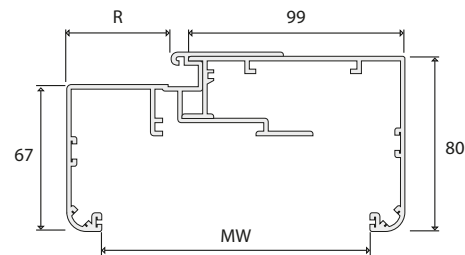

TYPE AL2 (12-14,5 cm)

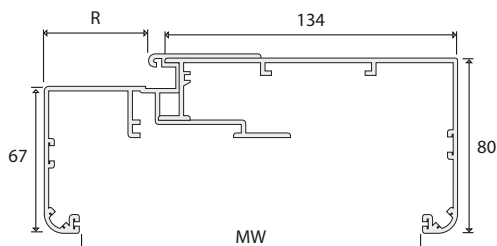

TYPE AL3 (15-18 cm)

R: 40 mm (Adjustable clip reducer of 35mm).

MW: soleco can cover any width of wall.

section



specifications

Characteristics: Two piece telescopic aluminium frame adjustable for various wall widths.

Application: Brick and drywall.

Mounting system: Following construction of the walls via three types of join in the corners and affixed with screws in the internal side of the seal.

Materials: Silver coloured anodized aluminium.

Types of frames: All (see pages 68-69)

Finishes: Anodized silver or RAL lacquer.

Hardware: Standard adjustable door hinge, adjustable hinge, spring hinge and concealed hinge.

Structural opening: Width of leaf + 7cm / Height of the leaf + 4cm.

Maximum thickness of wooden pre-frame: 2 cm.

TYPE ALR

ALR1 / ALR2 / ALR3

STRAIGHT ANGLE

profiles

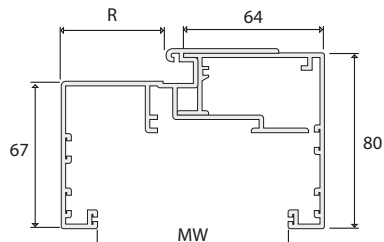

TYPE ALR1 (9-11,5 cm)

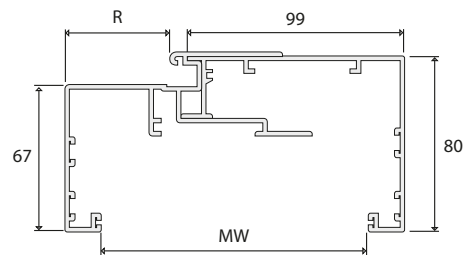

TYPE ALR2 (12-14,5 cm)

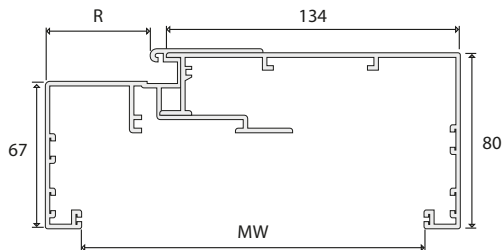

TYPE ALR3 (15-18 cm)

R: 40 mm (Adjustable clip reducer of 35mm).

MW: soleco can cover any width of wall.

section



specifications

Characteristics: Two piece telescopic aluminium frame adjustable for various wall widths.

Application: Brick and drywall.

Mounting system: Following construction of the walls via three types of join in the corners and affixed with screws in the internal side of the seal.

Materials: Silver coloured anodized aluminium.

Types of frames: All (see pages 68-69)

Finishes: Anodized silver or RAL lacquer.

Hardware: Standard adjustable door hinge, adjustable hinge, spring hinge and concealed hinge.

Structural opening: Width of leaf + 7cm / Height of the leaf + 4cm.
Maximum thickness of wooden pre-frame: 2 cm.



ZONA VIGILADA
NIVEL 2 (ALTA Dosis)

ZONA VIGILADA
NIVEL 3 (ALTA Dosis)

ZONA VIGILADA
NIVEL 4 (ALTA Dosis)

23

25



special ALUMINIUM

Special solutions, also in aluminium. Sliding doors, swing doors, radiation-proof or for flush-mounting panels... At Soleco we know how to offer our customers the best possible service.



SPECIAL ALCFT

SLIDING OPEN POCKET

profile

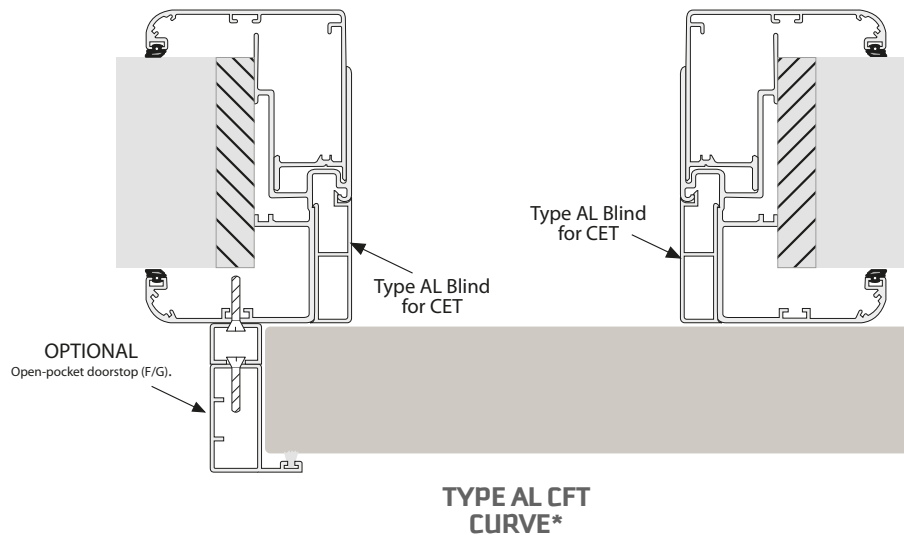

* Also available in AL STRAIGHT.

track cover mounting



specifications

Characteristics: Two piece aluminium frame adjustable for different depths of wall.

Application: Brick walls and drywalls.

Mounting system: After wall construction via three types of join in the corners and affixed with screws in the internal side of the seal.

Materials: Silver coloured anodized aluminium.

Types of frames: All (see pages 68-69)

Finishes: Anodized silver or RAL lacquer.

SPECIAL ALCET

SLIDING POCKET

profile

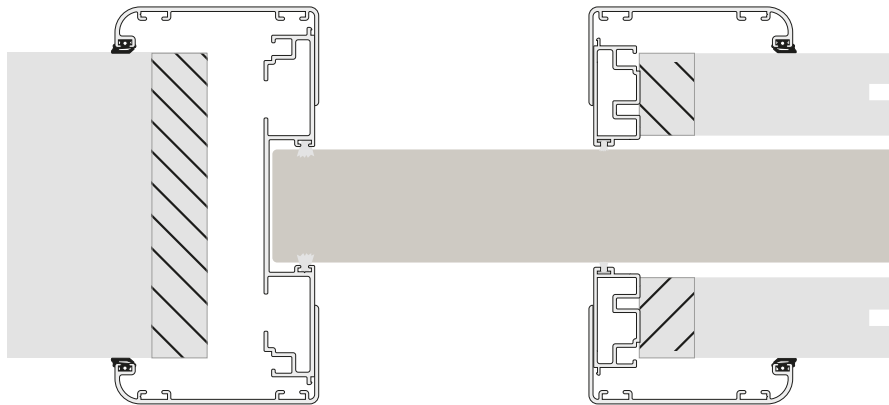

TYPE AL CET
CURVE*

* Also available in AL STRAIGHT.

Finishes



specifications

Characteristics: Two piece aluminium frame, adjustable for different depths of wall.

Application: Brick walls and drywalls.

Mounting system: After wall construction, via three types of join in the corners and affixed with screws in the internal side of the seal.

Materials: Silver coloured anodized aluminium.

Types of frames: All (see pages 68-69)

Finishes: Anodized silver or RAL lacquer.

SPECIAL ALVAIV

SWING DOOR

profile

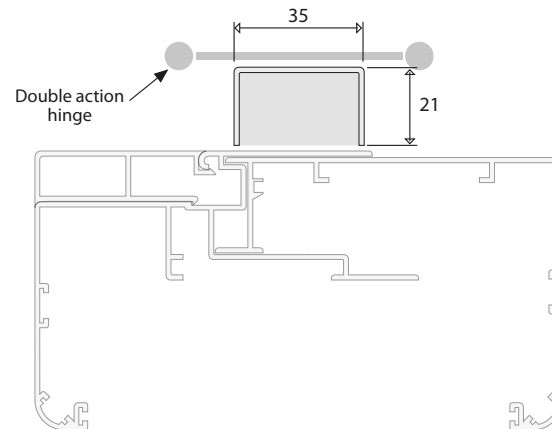

TYPE AL VAIV
CURVE*

* Also available in AL STRAIGHT.

section



specifications

Characteristics: Two piece aluminium frame, adjustable for different depths of wall.

Application: Brick walls and drywalls.

Mounting system: After wall construction, via three types of join in the corners and affixed with screws in the internal side of the seal.

Materials: Silver coloured anodized aluminium.

Types of frames: All (see pages 68-69).

Finishes: Anodized silver or RAL lacquer.

Hardware: Double action hinges. Not included.

SPECIAL ALEMP

LEAD LINED

profile

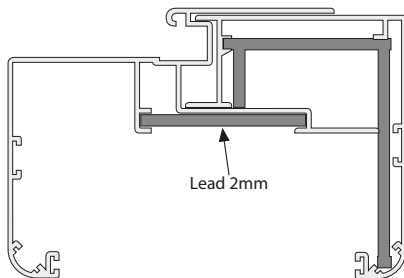

ALEMP*

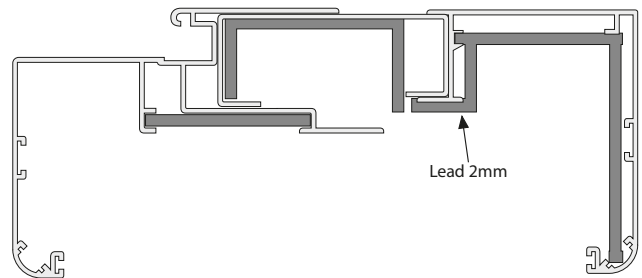

**ALEMP* + accessory for
very thick walls**

Can be mounted with AL1, AL2, AL3, ALR1, ALR2 and ALR3.

MW: Soleco can cover any width of wall.

* Also available in AL STRAIGHT.

finish



ALEMP



**ALEMP
+ accessory**

specifications

Characteristics: Frame prepared for X-rays.

Application: Areas where X-rays are used.

Mounting system: After construction of the walls, via three types of join in the corners and affixed with screws in the internal side of the seal.

Materials: Silver coloured anodized aluminium with a lead lining. Standard thickness of lead lining is 2mm.

Types of frames: All. (see pages 68-69)

Finishes: Anodized silver or RAL lacquer.

Hardware: Double action hinge not included

Structural opening: Width of leaf + 7cm / Height of the leaf + 4cm.
Maximum thickness of wooden pre-frame: 2 cm.

SPECIAL AL-INT

FLUSH-WITH-WALL inward opening

profile

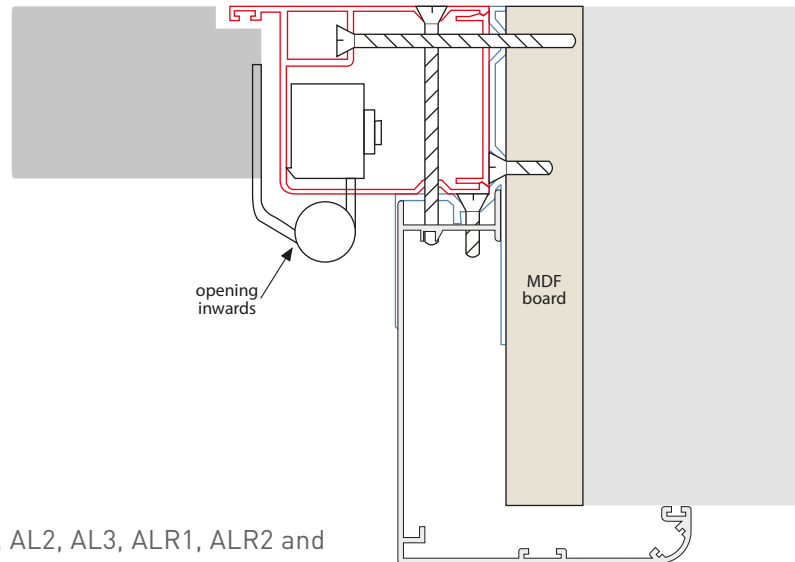

* Permits mounting AL1, AL2, AL3, ALR1, ALR2 and ALR3.

finish



specifications

Characteristics: special frame designed for flush-with-wall doors.

Application: Brick walls and drywall.

Mounting system: After completion of the walls. It is advisable to fix to an MDF pre-frame (see diagram)

Materials: Anodized aluminium.

Types of frames: Specific for panelling.

Finishes: Anodized silver or RAL lacquered.

Hardware: Standard hinge for doors with 5,5 cm thickness. Special hinge for flush mounted doors of 4,5 cm thickness.

SPECIAL AL-EXT

FLUSH-WITH-WALL outward opening

profile

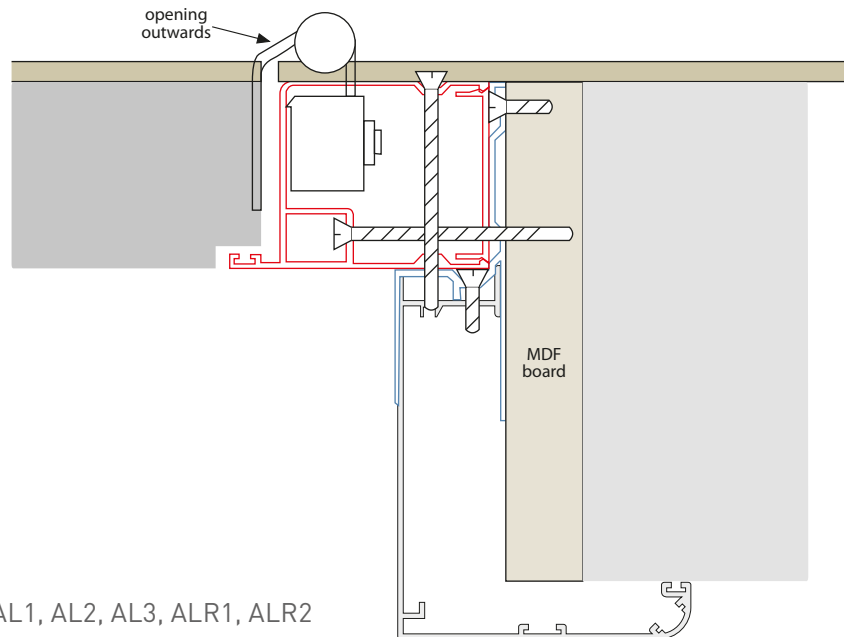

* Permits mounting with AL1, AL2, AL3, ALR1, ALR2 and ALR3.

finish



specifications

Characteristics: special frame designed for flush-with-wall doors

Application: Brick walls and drywall.

Mounting system: After completion of the walls. It is advisable to fix to an MDF pre-frame (see diagram)

Materials: Anodized aluminium.

Types of frames: Specific for paneling.

Finishes: Anodized silver or RAL lacquered.

Hardware: Standard hinge for doors with 5,5 cm thickness. Special hinge for flush mounted doors of 4,5 cm thickness.

NOTE: Possibility of using concealed hinge with 10 mm displacement.



aluminium assembly instructions

All the frames come referenced according to their measurements, the direction of opening, the wall thickness and the plan reference. The various stages during the mounting of the frame are described, this always taking place once construction of the walls is completed. A flat surface is required – this can be a wooden pre-frame, a piece of drywall or directly onto the profile of the wall.



ALUMINIUM assembly

SYSTEM OF ASSEMBLY

Assembly of the frame and fitting of the rubber perimeter seal

Joining of the corners using three brackets to guarantee a perfect result.



Brackets



Connection



Result

Fixing to the wall using screws

Soleco frames are fitted with a rabbet to ensure that all of the frame is correctly held to the wall.



Joining of both parts

Union of the pieces is achieved by the insertion of a screw in the internal part of the seal.

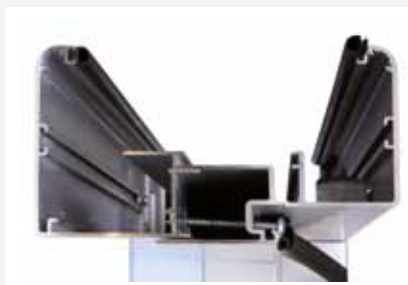

Dimensions of the structural opening for adjustable frames AL
Width of leaf + 7cm - Height of the leaf + 4cm.

ALUMINIUM assembly

CHARACTERISTICS AND ADVANTAGES

Characteristics and advantages

- Frames are adjustable to various widths of wall (2,5 cm)
- Perfect assembly and union with the wall
- Shock-absorbing rubber perimeter seal
- Frames are covered with a protective film to prevent damage during installation
- **Stainless steel adjustable hinges (100x77x3)**



Detail of the seal



Detail of adjustable hinge

The packaging used by Soleco helps to maintain the products in perfect condition. Each item is supplied with a reference indicating the measurements of the work, opening side and the thickness of the wall.

Each frame is supplied in an individual plastic cover to protect it. Furthermore, the aluminium profiles are covered with adherant film to prevent any deterioration. Assembly components are grouped together in a bag to avoid their dispersion and possible loss.

The desire to offer the best possible service to their clients means that Soleco are constantly striving to improve our products



Soleco frames allow the fitting of any type of door: melamine, laminated, compact, carpentry, etc.





WARDROBES CLOSETS

Special solutions, in aluminium, galvanised and stainless steel.
Perfectly finished wardrobes and closets to fit any space.



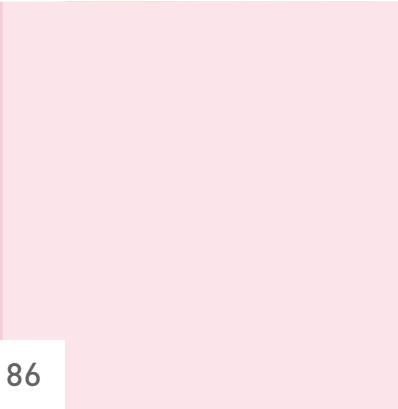
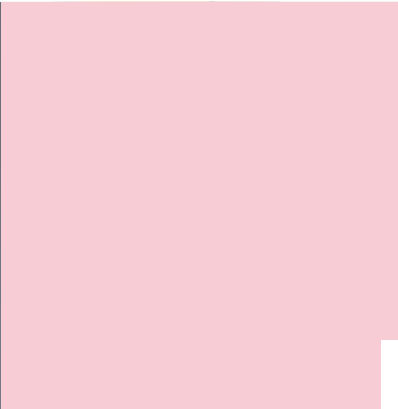
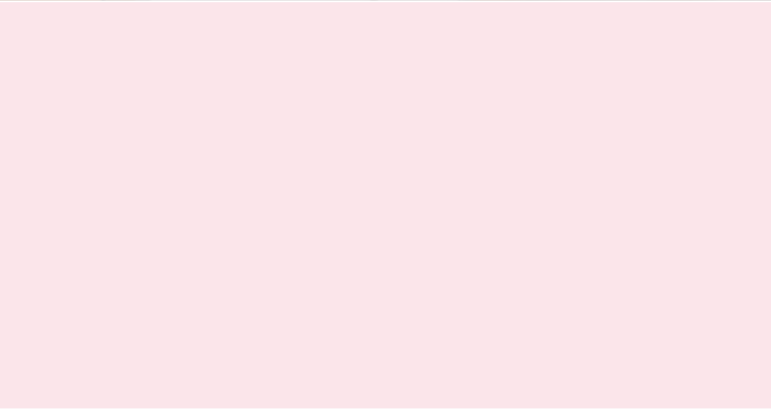
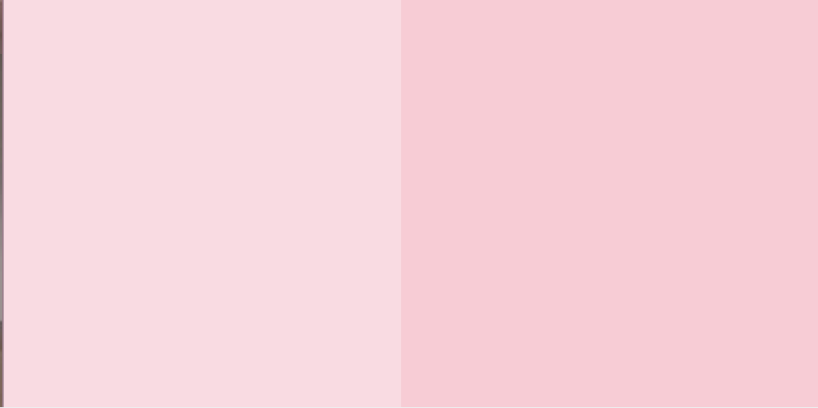

WARDROBES AND CLOSETS

types of wardrobes and closets

Available in aluminium, galvanised steel and stainless steel.

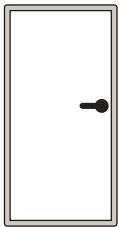

AAR

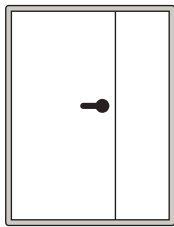

AARD

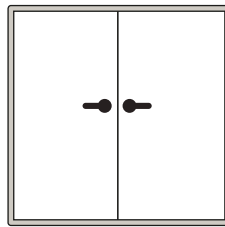

AAR2

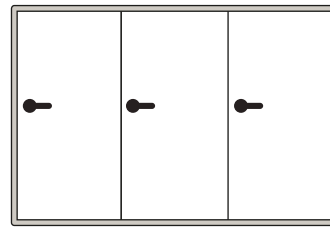

AAR2

* Please consult us for more design options.

types of profile

Aluminium:

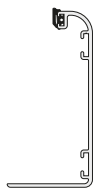

cover AL with cabinet hinge



cover ALR with cabinet hinge

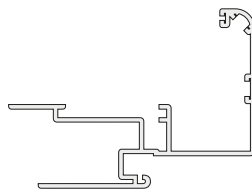

1/2 rebate AL with standard hinge

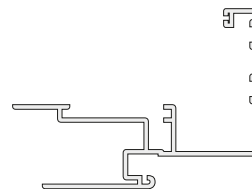

1/2 rebate ALR with standard hinge

Steel:

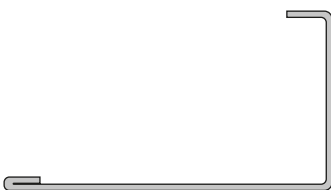

cover with cabinet hinge

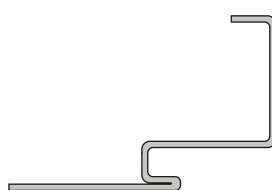

1/2 rebate with standard hinge





WINDOWS SOLECO

something more than frames

Soleco is committed towards offering an integrated service where our clients can find all the solutions they require, and in this case, windows are no exception.



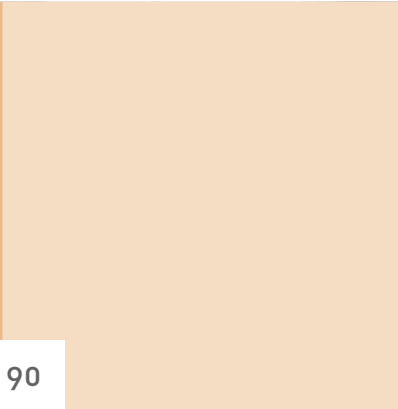
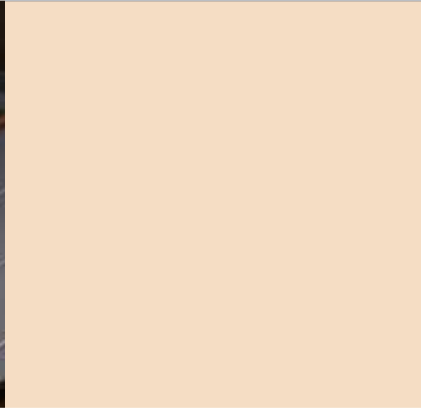
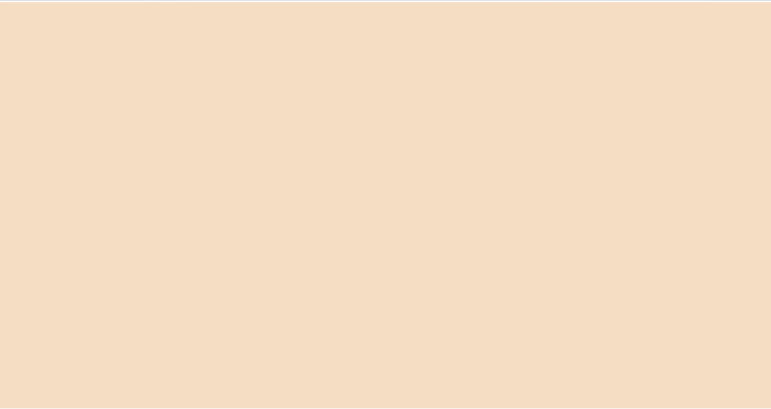
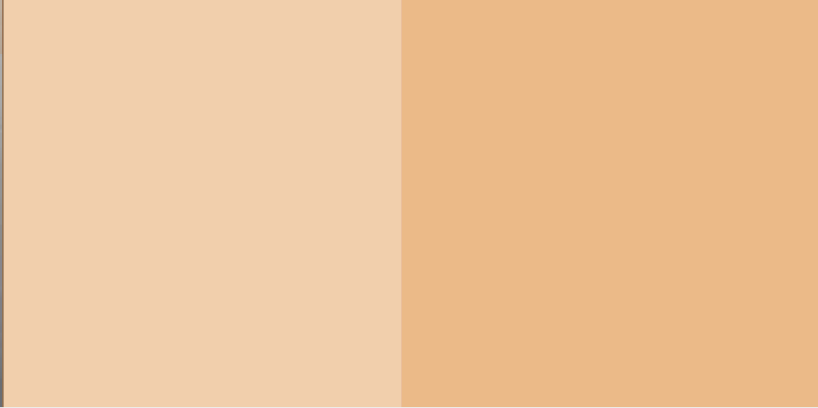

WINDOWS STEEL / STAINLESS STEEL / ALUMINIUM

windows (can be manufactured in all the frame profiles F, G or AL)

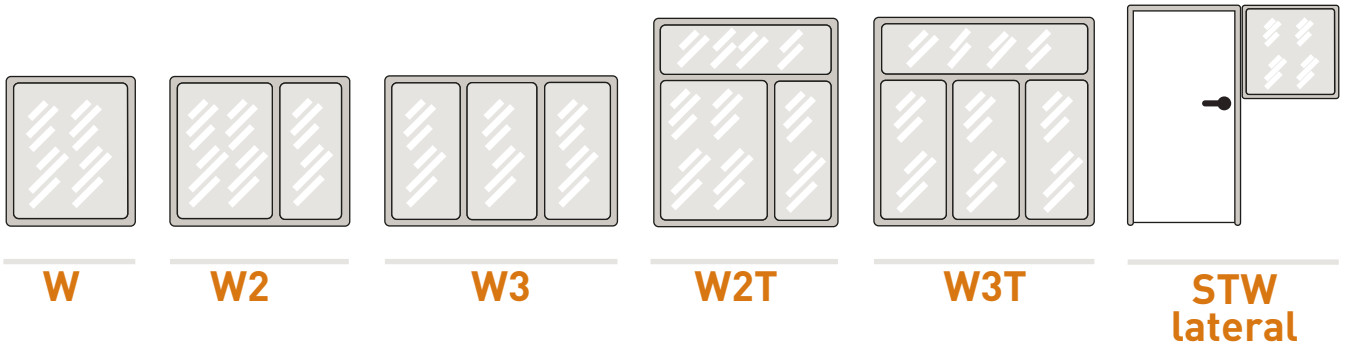

transom options

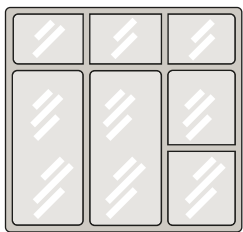

possibility to add intermediate rails

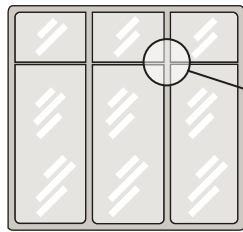

possibility of a transom with small T



detail of union between small T and large T in stainless steel and aluminium

types of transom

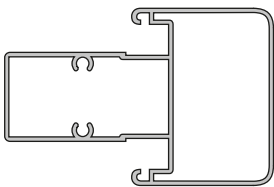

Large Transom

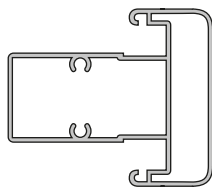

Small Transom

*Stainless steel plated available for T large, T small and moulding

NOTE: Lead-lined windows are available

WINDOW

TILT WINDOW

profile

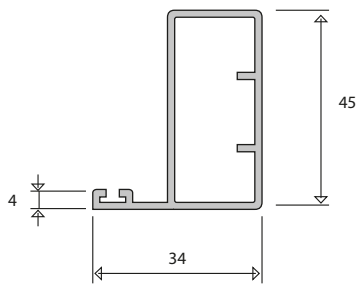

Window AL
for transom

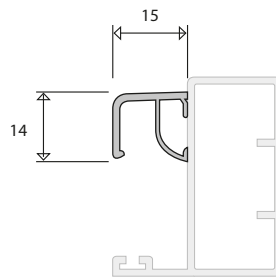

Curved moulding
for glass

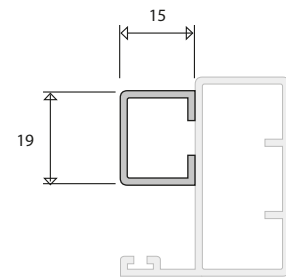

Straight moulding
for glass

tilt window



specifications

Characteristics: Always manufactured in aluminium.

Application: recommended for ventilation.

Mounting system: Screwed to the frames. Knock-down system®.

Materials: Anodized aluminium.

Types of frames: All (see page 91).

Finishes: Anodized silver, pre-painted or RAL lacquered.

NOTE: This window can be mounted to the frames with a fixed upper or side.

WINDOW

DOUBLE GLAZED

profile

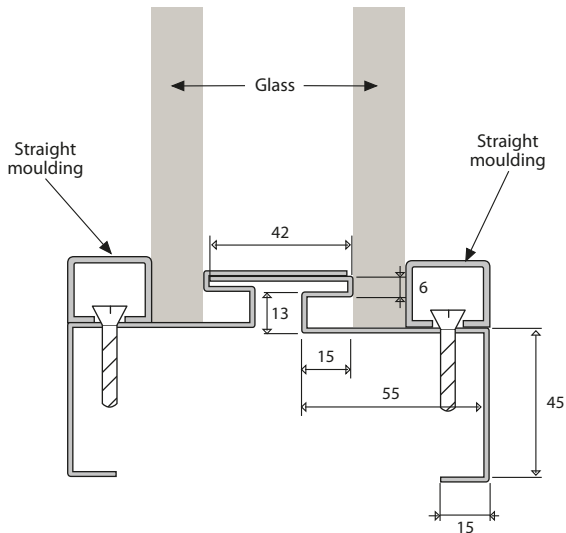

TYPE VG-VDD

specifications

Characteristics: System G, telescopic. Manufactured in steel.

Application: Double glazed windows.

Mounting system: Knock-down system®.

Materials: Galvanised steel 1,5 mm and stainless steel 1,2 mm.

Types of frames: Only the one illustrated.

Finishes: Pre-painted or RAL lacquered.

WINDOW

SLIDING

profile



specifications

Characteristics: System G, telescopic. Manufactured in steel.

Application: Sliding windows.

Mounting system: Knock-down system®.

Materials: Galvanised steel 1,5 mm and stainless steel 1,2 mm.

Types of frames: Only the one illustrated.

Finishes: Pre-painted or RAL lacquered.





PARTITIONS

solutions of every kind

Partitions are ideal for offices, consulting rooms and spaces dedicated to attending to the public... As might be expected, in this section Soleco also offers you a wide range of possibilities in steel, aluminium and stainless steel.



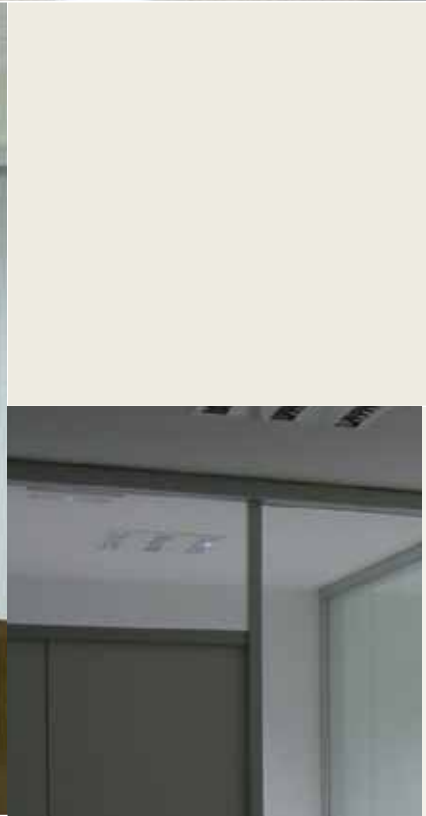
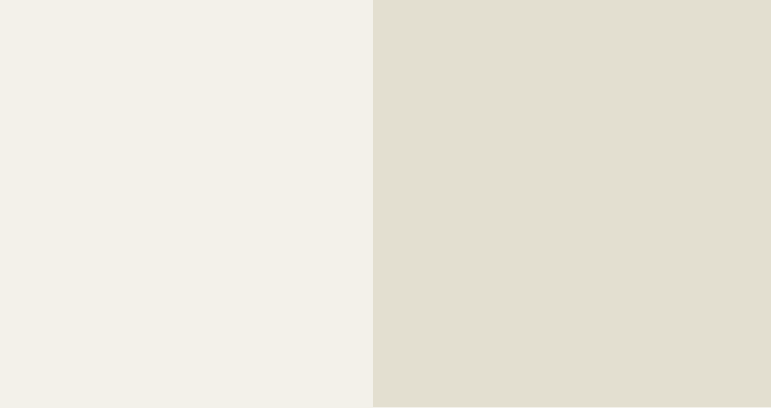



PARTITIONS

partitions (can be manufactured in all of the frame profiles F, G, or AL)

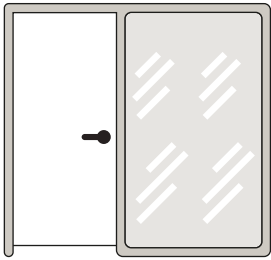

MSW1

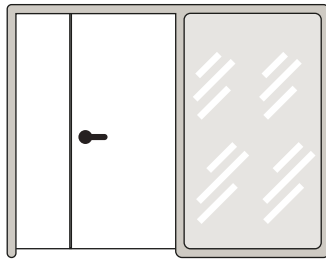

MDW1

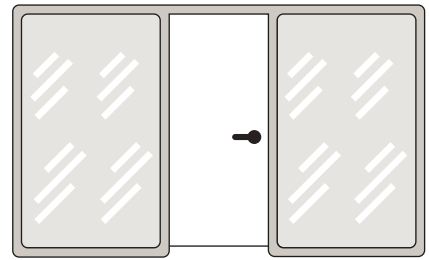

MSW2

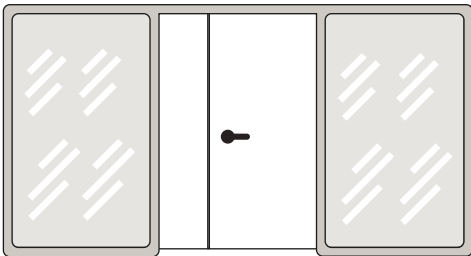

MDW2

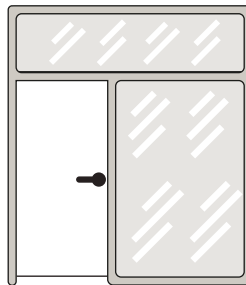

MSTW1

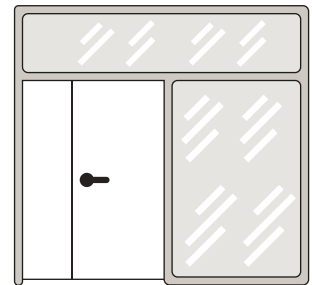

MSTDW1

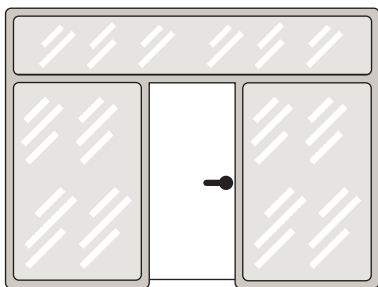

STW2

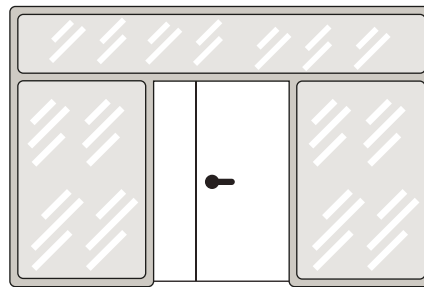

STW2

STEEL / STAINLESS STEEL / ALUMINIUM

transom options

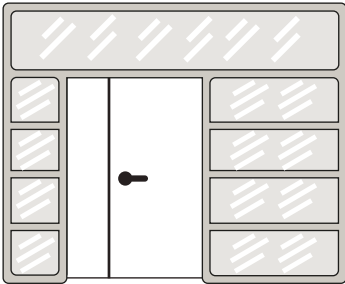

possibility to add intermediate rails

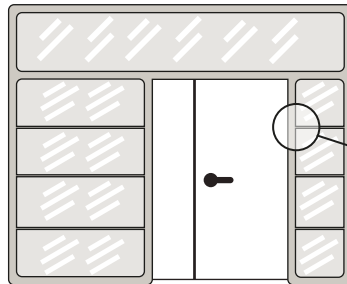

possibility to add intermediate rails



detail of union between small T and large T in stainless steel and aluminium.

types of separators

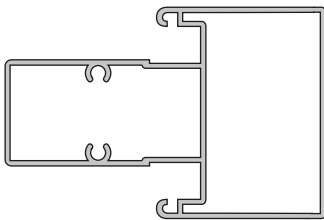

Large transom

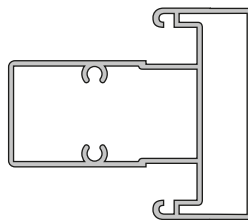

Small transom

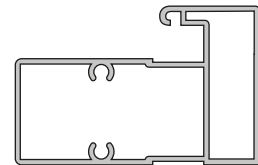

Lower transom

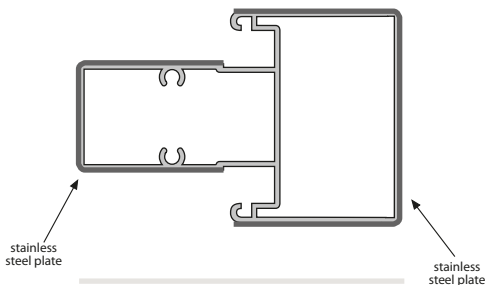

Large transom plated with stainless steel

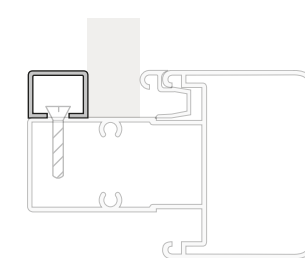

Straight moulding

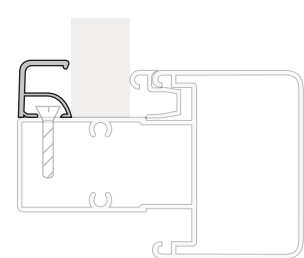

Curved moulding

*The curved and straight mouldings and the transoms are available plated with stainless steel.



ACCESSORIES **protectors** **and hardware** **for all types of frames and doors**

Concealed hinges, hinges with displacement, for glass,...
escutcheons, etc. Soleco offers a wide range of accessories that
further denote the quality of our products.

ACCESSORIES

HARDWARE

STAINLESS STEEL

STANDARD DOOR HINGE



Standard door hinge for Soleco housings
100 x 86 x 3

**Always supplied as the standard hinge for Soleco Frames.
The hinge is certified by AIDIMA for 200.000 openings.**

All the hinges are manufactured exclusively in stainless steel.

KNUCKLE HINGE 20



Knuckle hinge (20mm) with a double Teflon separator.
Intended for Soleco adjustable housings.

Also available with a return spring incorporated.

All the hinges are manufactured exclusively in stainless steel.

CONCEALED HINGE



Concealed hinge. Can be used on all Soleco frames
except for the outward-opening flush panel frame.

ACCESSORIES

HARDWARE

STAINLESS STEEL

CONCEALED HINGE WITH DISPLACEMENT



Concealed hinge with displacement of 12mm.
Especially indicated for use with the frame for flush-mounted panels (outward-opening).

HINGE FOR GLASS

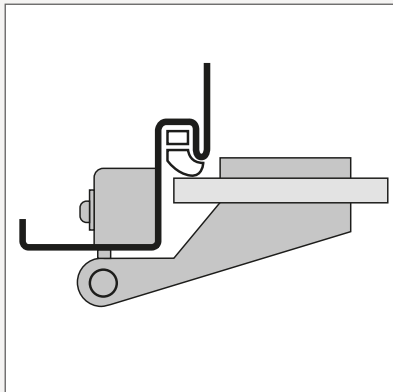

Hinge for Soleco housings in frames for glass (F-G-AL) and any other type of hinge for glass that is to be screwed to the transom.

FLUSH MOUNTING HINGE



Standard Soleco hinge for door of 50.
Modified Soleco hinge for door of 45.

All the hinges are manufactured exclusively in stainless steel.

ACCESSORIES

LOCK ESCUTCHEONS

STAINLESS STEEL

SIMPLE LOCK ESCUTCHEON PLATE



Special Soleco protector plate in stainless steel with a housing for a basic lock and curvature according to the door opening direction.

DOUBLE LOCK ESCUTCHEON WITH BASIC HOUSING



Special Soleco protector plate in stainless steel, double size, with a housing for a basic lock and edge curvature according to the door opening direction.

LOCK ESCUTCHEON WITH DOUBLE HOUSING



Special Soleco double protector plate in stainless steel, with a housing for a double lock and edge curvature according to the door opening direction.

ACCESSORIES

PROTECTORS AND REDUCERS STAINLESS STEEL

FRAME HIDING SYSTEM

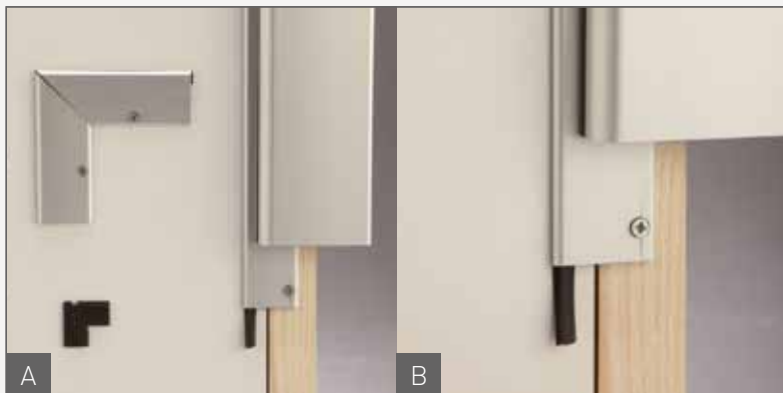

A: Frame hiding system.

B: Detail.

Manufactured in aluminium.

REDUCER OF 3.5 FOR ALUMINIUM FRAMES

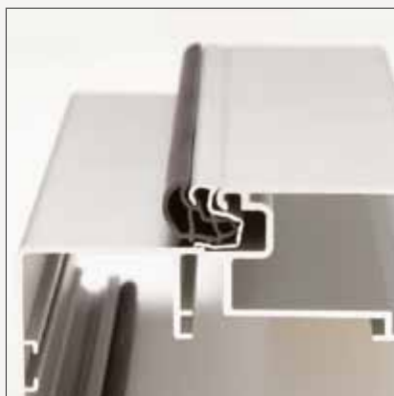

Supplement for aluminium frames that reduces the rebate for leaves of 3.5 Easy assembly.

Manufactured in aluminium.

WALL PROTECTORS



A: Steel wall protector.

B: Steel corner protector

Available in stainless steel and RAL lacquered finishes.





COMPLE MENTS

more possibilities
for your projects



COMPLEMENTS

DOOR KICK PLATES AL/STAINLESS STEEL

DOOR KICK PLATES IN ALUMINIUM OR STAINLESS STEEL

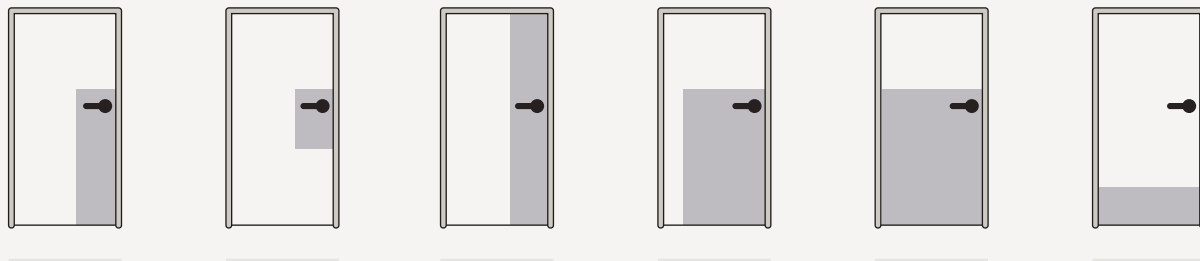

COMPLEMENTS

EDGE PROTECTORS

AL / STAINLESS STEEL

EDGE PROTECTORS IN ALUMINIUM OR STAINLESS STEEL

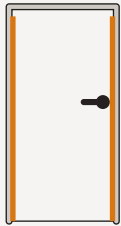

2C

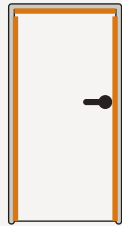

3C

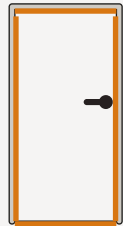

4C

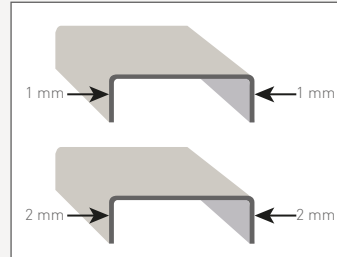

Protectors in aluminium and stainless steel of 1 and 2 mm for doors of 35, 40 and 45.

They can be supplied perforated for the standard Soleco door hinge, closure with the Soleco concealed hinge, upper and lower latches, double door, latch for double doors or latch for a single leaf door.

EXAMPLES OF STAINLESS STEEL PROTECTORS



COMPLEMENTS

ANTI-SLAM AL/STAINLESS STEEL

detail

Complement specially indicated for use in schools and nurseries.



ANTI-SLAM HINGE



FINGER GUARD

finish



COMPLEMENTS

PORTHOLE

AL/STAINLESS STEEL

finish



COMPLEMENTS

BEADING FOR WINDOWS

detail



COMPLEMENTS

SKIRTING AL/STAINLESS STEEL

profile

Special Soleco skirting to match the frame. Available in stainless steel and aluminium. Measures 100 cm with the possibility to cut-down to 70, 80 and 90 cm.

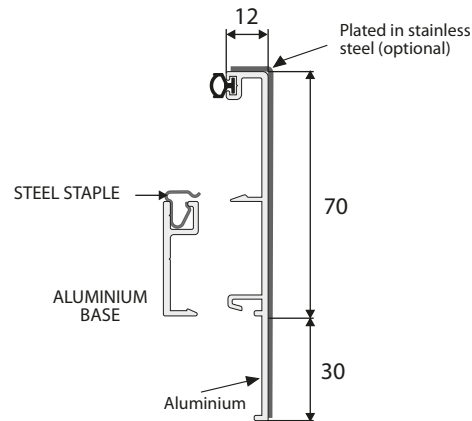

SPECIAL SOLECO SKIRTING

finish



COMPLEMENTS

WALL PROTECTOR AL/STAINLESS STEEL

profile

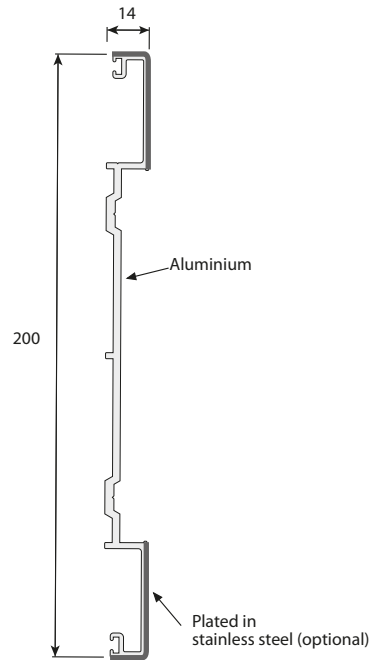

WALL PROTECTOR

finish





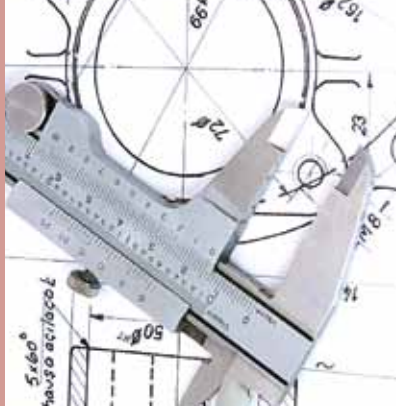

quality
our commitment
with quality your
peace of mind



QUALITY

STEEL



**CERTIFICATION OF SOLECO FRAMES BY
METALIC-PROCESSING TECHNOLOGY INSTITUTE, (AIMME)**

- Metallic materials tensile testing, according to regulation UNE EN 10002-1:02.
- Non-magnetic coatings on magnetic substrates, regulation UNE-EN ISO 2178:1996.

QUALITY

ALUMINIUM



**CERTIFICATION OF SOLECO FRAMES BY
METALIC-PROCESSING TECHNOLOGY INSTITUTE, (AIMME)**

- Metallic materials tensile testing, according to regulation UNE EN 10002-1:02.
- Measurement of anodized coating, according to regulation UNE-EN ISO 22360:04.
- Regulation UNE-EN-573-3 "Chemical composition".
- Regulation UNE-515 "Temper Designations".
- Regulation UNE-EN-755-9 and UNE-EN-12020-2.
- Guidelines of the regulation QUALANOD.

QUALITY

ALUMINIUM

QUALITY CERTIFICATION

The regulations followed in the process of fabricating aluminium profiles by extrusion are the following:

- UNE-EN 755-9 and 12020-2. Aluminium and aluminium alloys. Profiles, tolerances on dimensions and form.
- UNE-EN 515. Aluminium and aluminium alloys. Designation of treatment states.
- UNE-EN-573-3. Aluminium and aluminium alloys. "Chemical composition".

Los perfiles extruidos para la empresa Soleco Traders S.L. se fabrican a partir de aleaciones EN A W-6060 o EN A W-6063

AUTHORISATION TO USE THE QUALITY MARK



LACQUERING APPLICATION PROCESS

- This process involves four, clearly distinguishable phases that are described as follows:
- The pieces are suspended on a closed circuit production line, also called “aerial” that is used to transport the pieces throughout the production processes in order to achieve a high quality powder coating.

PHASE ONE: PHASE OF NANOTECHNOLOGICAL PRETREATMENT.

PHASE TWO: DRYING.

PHASE THREE: PAINTING.

PHASE FOUR: POLYMERISATION PHASE.

PHASE FIVE: PACKING.

CERTIFICATES:



product tested and approved for the quality mark

**NOTE: All of Soleco's suppliers comply with existing legislation.
Measurements are not contractually binding.
They are approximate measurements.**







Soleco Frames |

C/ Marjal, 8 - nave A - 46770 Xeraco (Valencia)

T. +34 962 891 149 / +34 962 890 922

F. +34 962 892 475

e-mail: info@e-soleco.com

www.e-soleco.com