

# User Manual

## VR10 Pro

Date: July 2021

Doc Version: 1.0

English

Thank you for choosing our product. Please read the instructions carefully before operation. Follow these instructions to ensure that the product is functioning properly. The images shown in this manual are for illustrative purposes only.



For further details, please visit our Company's website  
[www.zkteco.com](http://www.zkteco.com).

Copyright © 2021 ZKTECO CO., LTD. All rights reserved.

Without the prior written consent of ZKTeco, no portion of this manual can be copied or forwarded in any way or form. All parts of this manual belong to ZKTeco and its subsidiaries (hereinafter the "Company" or "ZKTeco").

## Trademark

**ZKTeco** is a registered trademark of ZKTeco. Other trademarks involved in this manual are owned by their respective owners.

## Disclaimer

This manual contains information on the operation and maintenance of the ZKTeco equipment. The copyright in all the documents, drawings, etc. in relation to the ZKTeco supplied equipment vests in and is the property of ZKTeco. The contents hereof should not be used or shared by the receiver with any third party without express written permission of ZKTeco.

The contents of this manual must be read as a whole before starting the operation and maintenance of the supplied equipment. If any of the content(s) of the manual seems unclear or incomplete, please contact ZKTeco before starting the operation and maintenance of the said equipment.

It is an essential pre-requisite for the satisfactory operation and maintenance that the operating and maintenance personnel are fully familiar with the design and that the said personnel have received thorough training in operating and maintaining the machine/unit/equipment. It is further essential for the safe operation of the machine/unit/equipment that personnel has read, understood and followed the safety instructions contained in the manual.

In case of any conflict between terms and conditions of this manual and the contract specifications, drawings, instruction sheets or any other contract-related documents, the contract conditions/documents shall prevail. The contract specific conditions/documents shall apply in priority.

ZKTeco offers no warranty, guarantee or representation regarding the completeness of any information contained in this manual or any of the amendments made thereto. ZKTeco does not extend the warranty of any kind, including, without limitation, any warranty of design, merchantability or fitness for a particular purpose.

ZKTeco does not assume responsibility for any errors or omissions in the information or documents which are referenced by or linked to this manual. The entire risk as to the results and performance obtained from using the information is assumed by the user.

ZKTeco in no event shall be liable to the user or any third party for any incidental, consequential, indirect, special, or exemplary damages, including, without limitation, loss of business, loss of profits, business interruption, loss of business information or any pecuniary loss, arising out of, in connection with, or

relating to the use of the information contained in or referenced by this manual, even if ZKTeco has been advised of the possibility of such damages.

This manual and the information contained therein may include technical, other inaccuracies or typographical errors. ZKTeco periodically changes the information herein which will be incorporated into new additions/amendments to the manual. ZKTeco reserves the right to add, delete, amend or modify the information contained in the manual from time to time in the form of circulars, letters, notes, etc. for better operation and safety of the machine/unit/equipment. The said additions or amendments are meant for improvement /better operations of the machine/unit/equipment and such amendments shall not give any right to claim any compensation or damages under any circumstances.

ZKTeco shall in no way be responsible (i) in case the machine/unit/equipment malfunctions due to any non-compliance of the instructions contained in this manual (ii) in case of operation of the machine/unit/equipment beyond the rate limits (iii) in case of operation of the machine and equipment in conditions different from the prescribed conditions of the manual.

The product will be updated from time to time without prior notice. The latest operation procedures and relevant documents are available on <http://www.zkteco.com>.

If there is any issue related to the product, please contact us.

## ZKTeco Headquarters

**Address**            ZKTeco Industrial Park, No. 32, Industrial Road,  
Tangxia Town, Dongguan, China.

**Phone**             +86 769 - 82109991

**Fax**                 +86 755 - 89602394

For business related queries, please write to us at: [sales@zkteco.com](mailto:sales@zkteco.com).

To know more about our global branches, visit [www.zkteco.com](http://www.zkteco.com).

## About the Company

ZKTeco is one of the world's largest manufacturer of RFID and Biometric (Fingerprint, Facial, Finger-vein) readers. Product offerings include Access Control readers and panels, Near & Far-range Facial Recognition Cameras, Elevator/Floor access controllers, Turnstiles, License Plate Recognition (LPR) gate controllers and Consumer products including battery-operated fingerprint and face-reader door locks. Our security solutions are multi-lingual and localized in over 18 different languages. At the ZKTeco state-of-the-art 700,000 square foot ISO9001-certified manufacturing facility, we control manufacturing, product design, component assembly, and logistics/shipping, all under one roof.

The founders of ZKTeco have been determined for independent research and development of biometric verification procedures and the productization of biometric verification SDK, which was initially widely applied in PC security and identity authentication fields. With the continuous enhancement of the development and plenty of market applications, the team has gradually constructed an identity authentication ecosystem and smart security ecosystem, which are based on biometric verification techniques. With years of experience in the industrialization of biometric verifications, ZKTeco was officially established in 2007 and now has been one of the globally leading enterprises in the biometric verification industry owning various patents and being selected as the National High-tech Enterprise for 6 consecutive years. Its products are protected by intellectual property rights.

## About the Manual

This manual introduces the operations of **VR10 Pro**.

All figures displayed are for illustration purposes only. Figures in this manual may not be exactly consistent with the actual products.





## Document Conventions

Conventions used in this manual are listed below:

### GUI Conventions

For Software	
Convention	Description
<b>Bold font</b>	Used to identify software interface names e.g. <b>OK, Confirm, Cancel</b> .
>	Multi-level menus are separated by these brackets. For example, File > Create > Folder.
For Device	
Convention	Description
<>	Button or key names for devices. For example, press <OK>.
[]	Window names, menu items, data table, and field names are inside square brackets. For example, pop up the [New User] window.
/	Multi-level menus are separated by forwarding slashes. For example, [File/Create/Folder].

### Symbols

Convention	Description
	This represents a note that needs to pay more attention to.
	The general information which helps in performing the operations faster.
	The information which is significant.
	Care taken to avoid danger or mistakes.
	The statement or event that warns of something or that serves as a cautionary example.

## Table of Contents

<b>1</b>	<b>PRODUCT INTRODUCTION.....</b>	<b>6</b>
<b>2</b>	<b>FUNCTIONS .....</b>	<b>6</b>
<b>3</b>	<b>APPEARANCE AND DIMENSIONS .....</b>	<b>7</b>
<b>4</b>	<b>PARAMETERS .....</b>	<b>7</b>
<b>5</b>	<b>INSTALLATION INSTRUCTION .....</b>	<b>9</b>
<b>6</b>	<b>PRODUCT INSTALLATION .....</b>	<b>10</b>
<b>7</b>	<b>WIRING .....</b>	<b>12</b>
<b>8</b>	<b>DEBUG RADAR WITH APP (RADAR ASSISTANT) .....</b>	<b>15</b>
8.1	DOWNLOAD AND INSTALL THE APP TO THE PHONE .....	15
8.2	CONNECT TO BLUETOOTH.....	16
8.3	SET PARAMETER FOR RADAR .....	17
8.4	BACKGROUND RECORDING.....	20
8.5	DISPLAY OF TARGET INFORMATION .....	21
<b>9</b>	<b>DEBUG RADAR WITH SOFTWARE .....</b>	<b>22</b>
<b>10</b>	<b>FAQ .....</b>	<b>24</b>
<b>11</b>	<b>PACKING LIST.....</b>	<b>24</b>

## 1 Product Introduction

VR10 Pro is the second generation of ZKTeco radars developed to detect and identify various vehicles (motorcycle, cars, trucks, etc.) and pedestrians near the barrier gate. It adopts highly integrated radio frequency chip, which has the characteristics of small size, low cost, all-weather work all day, high detection sensitivity, high accuracy, simple commissioning and installation, stability and reliability.

The operating frequency of this radar is 79GHz, the range resolution can reach 4cm, and the ranging accuracy is better than 2cm; the signal processing and control unit adopts DSP+ARM dual-core architecture. Through the joint optimization design of software and hardware, this product can accurately identify and distinguish between pedestrians and vehicles passing through the barrier area, and prevent the barrier from hitting people and cars. Also, users could set parameters of VR10 Pro with a mobile app (Radar Assistant) when connected it to Bluetooth.

## 2 Functions

- Support the simultaneous detection of vehicles (bicycles, motorcycles, cars, trucks) and pedestrians.
- The detection range is adjustable within 1-6m (default 3m).
- Simple installation and debugging, saving labor and material cost.
- The radar work is not affected by the external environment such as light, dust, rain and snow.
- Supports Bluetooth communication, allowing upgrade and debug with a mobile App (Radar Assistant).
- Support 485 communication, could upgrade and debug online.
- Straight boom are supported by default. Also support folding boom, fence boom, and advertising boom (need to learn to record the environment0).



### 3 Appearance and Dimensions

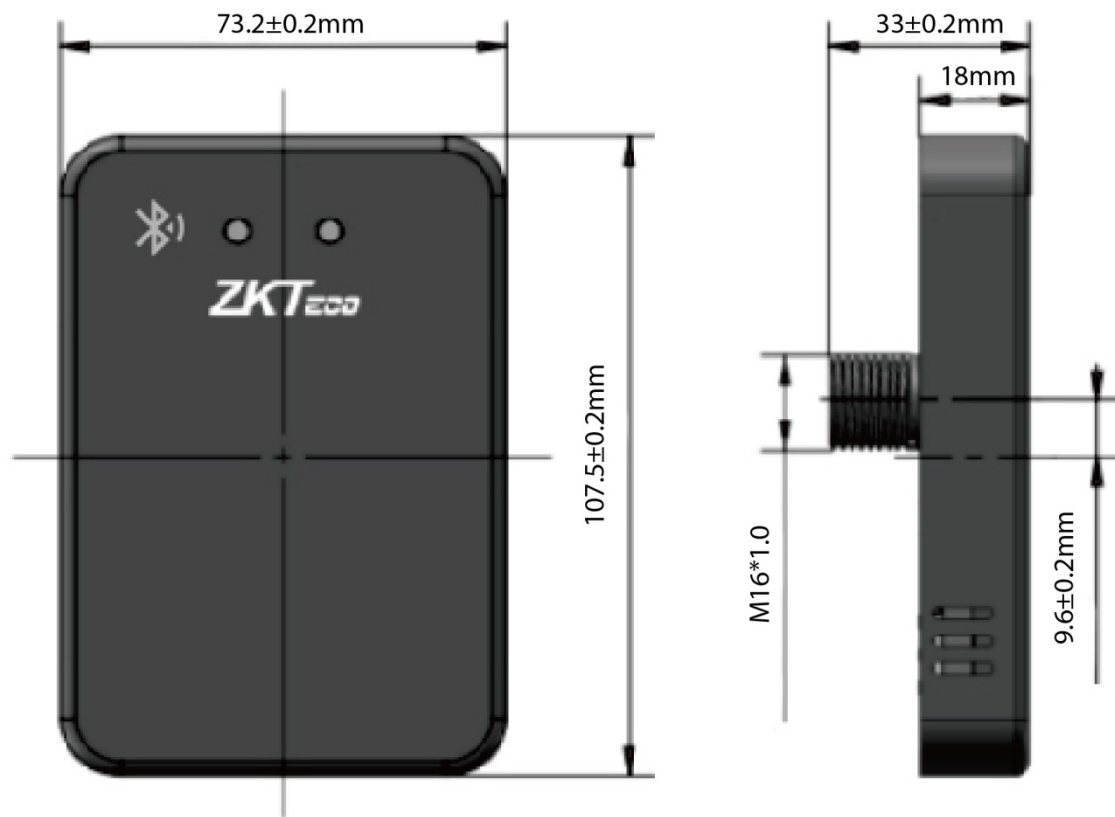

### 4 Parameters

Model	VR10 Pro
Detection Distance	1m to 6m (default 3m)
Working Voltage (V)	DC 10 to 16V
Working Current	0.2A
Working Temperature (°C)	-40°C to 85°C
Power Consumption (W)	<2.5
Antenna Transmit Power	12.5dBm



Antenna Gain	10dBi
Waterproof Rating	IP67
Communication Interface	Bluetooth, RS485, relay
Shell Size (L*H*W)	107.5*73.2*18mm
Packing Size (L*H*W)	166*94*97mm
Net Weight	228.4g
Gross Weight	314.6g
Supported App	Radar Assistant

## 5 Installation Instruction

1. The detection distance is 3m by default, and the supported boom type is a straight boom **by default**. If it needs to be changed, it can be set by App or software.
2. Cannot be applied to other sliding doors and telescopic doors.

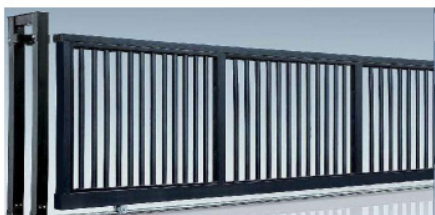

3. After changing the detection environment (such as installing a deflector, ice cream cone in the detection area), please re-learn to record the environment again by App or software.
4. Under normal circumstances, please set the detection distance according to the length of the boom. The detection distance is slightly less than or equal to the length of the boom to prevent people or objects outside the barrier boom from being detected by the radar.
5. If there is a misrecognition due to radar causing opening the gate or not closing, please re-learn the background.
6. The radar antenna is integrated inside. When the radar surface is covered with foreign objects (such as water drops, rain, snow, dust, etc.), it should be cleaned in time.
7. The detection field of the radar must be clean, and there must be no objects that affect the target detection (such as metal fences, billboards, license plate recognition cameras, walls, etc.) to prevent the radar from being triggered by mistake.
8. It is not recommended to use the radar in the fence and advertisement boom type for a single mixed-in and mixed-out scenario.
9. Dual-radar installation is recommended for semi-trailer, cement tanker, crane.
10. When learning to record the environment, the fence/advertisement boom may shaking after the it falls to the ground, and then wait for the boom to fully stabilize before performing subsequent operations.

## 6 Product Installation

### 1. Confirm radar mounting holes

The installation hole of the radar is between 200 to 300mm from the inside of the straight boom and 650 to 800mm from the driveway ground (non-cement pier); the installation position is shown in the figure.

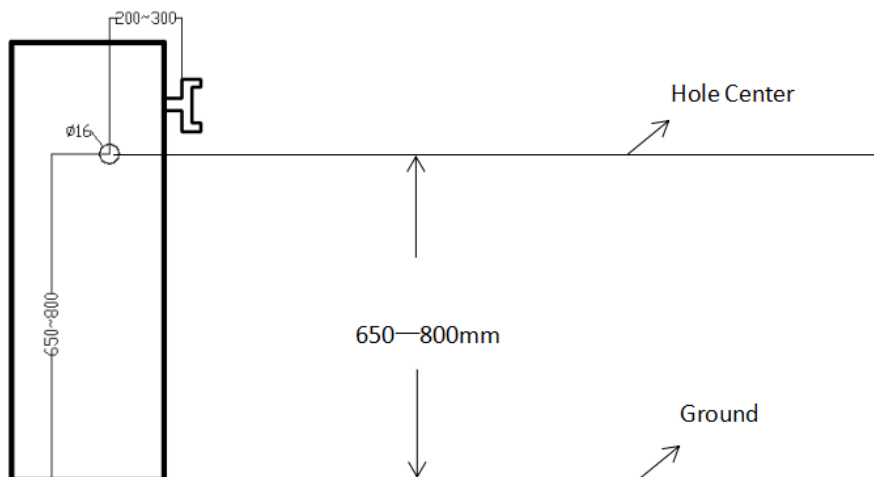

### 2. Drilling

Use an electric drill to drill a fixed hole suitable for M16 at the selected position of the barrier box. The recommended drill bit diameter is 16mm.

### 3. Fixed radar



(a) Radar through the box



(b) The wiring harness passes through the gasket and nut



(c) Fix the radar inside the cabinet



(d) Front display after installation

As shown in (a)-(d), the radar is fixed to the barrier box through the bottom bolt. First plug the radar into the barrier box, then cover the gasket with M16 screws to fix it, then insert the end of the wire harness into the radar in the correct direction and lock the metal buckle to complete the installation.

## 7 Wiring

### 1. Interface cable description

Cable Identification	Cable Color	Description	Wiring
12V	Red	Power	The red wire connected to the 12V power positive output terminal;
GND	Black	GND	The black wire "GND" is connected to the negative output terminal of the 12V power supply.
TX	Gray	A+	The gray wire "A+" is connected to T/R+ terminal of 485;
RX	White	B-	The white wire "B-" is connected to the T/R- terminal of 485.
Normally Open Signal Wire	Blue	NO1	The green and blue wires are normally open signals of the relay, connecting the ground sense coil terminals and the common terminals of the barrier control main board (no distinction between positive and negative).
	Green	NO1	
Normally Close Signal Wire	Brown	NC2	The brown and purple wires are normally close signals of the relay, connecting the ground sense coil terminals and the common terminals of the barrier control main board (no distinction between positive and negative).
	Purple	NC2	
Dip Switch	Orange	Input	The orange wire is connected to the yellow wire through the DIP terminal (the DIP terminal is divided into ON terminal and 1 terminal).
	Yellow	GND	



2. Connected to the barrier gate

When the radar is connected to the P15, PB4000, CMP200, BG1000 barrier gate, the normally open signal wire of the radar, that is, the blue and green wires, are connected to the ground sense coil terminals and common terminals of the barrier control main board (no distinction between positive and negative).

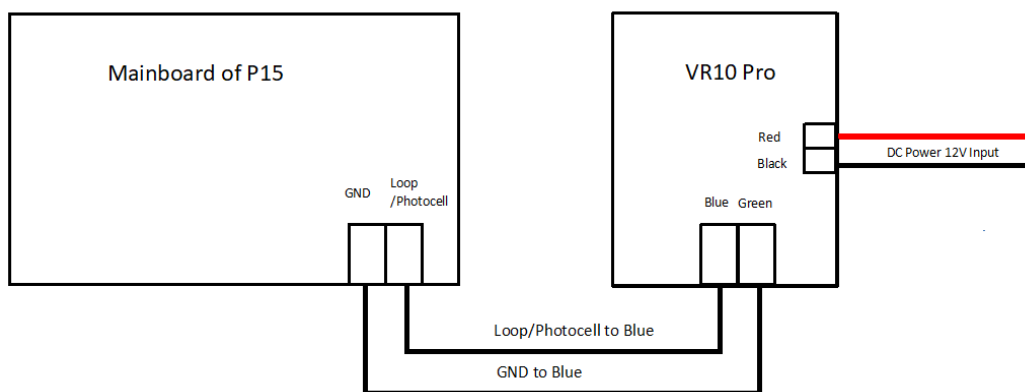

Radar connected to P15 barrier gate

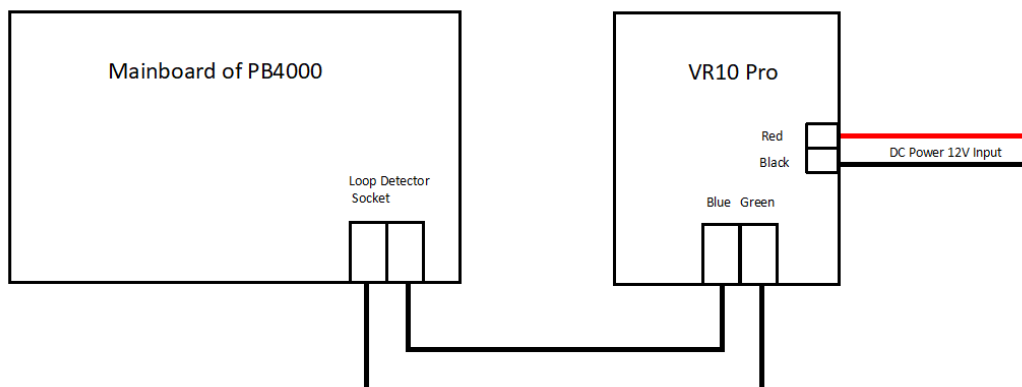

Radar connected to PB4000 barrier gate

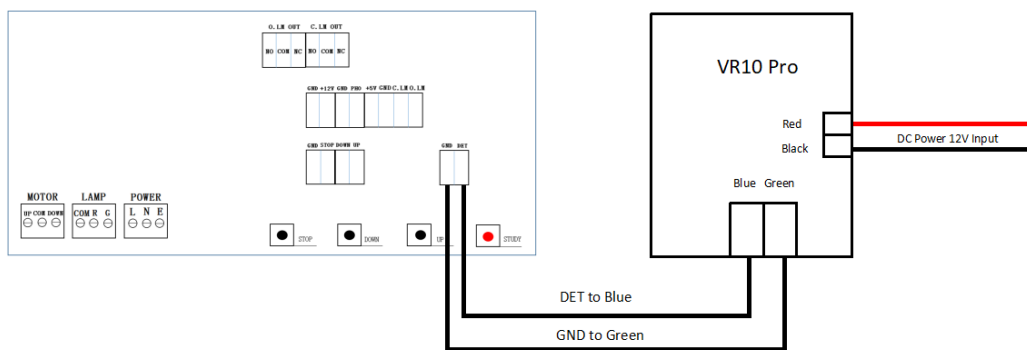

Radar connected to CMP200 barrier gate

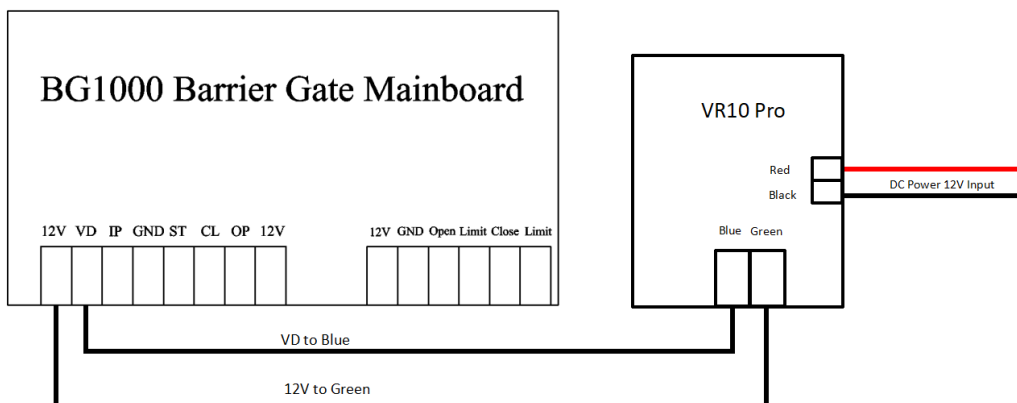

Radar connected to BG1000 barrier gate

**Note: ProBG (Wiring)**

When the radar is connected to the ProBG series barrier gate, the normally close signal wires of the radar, that is, the brown and purple wires, are connected to the ground sense coil terminals and common terminals of the barrier control main board (no distinction between positive and negative).

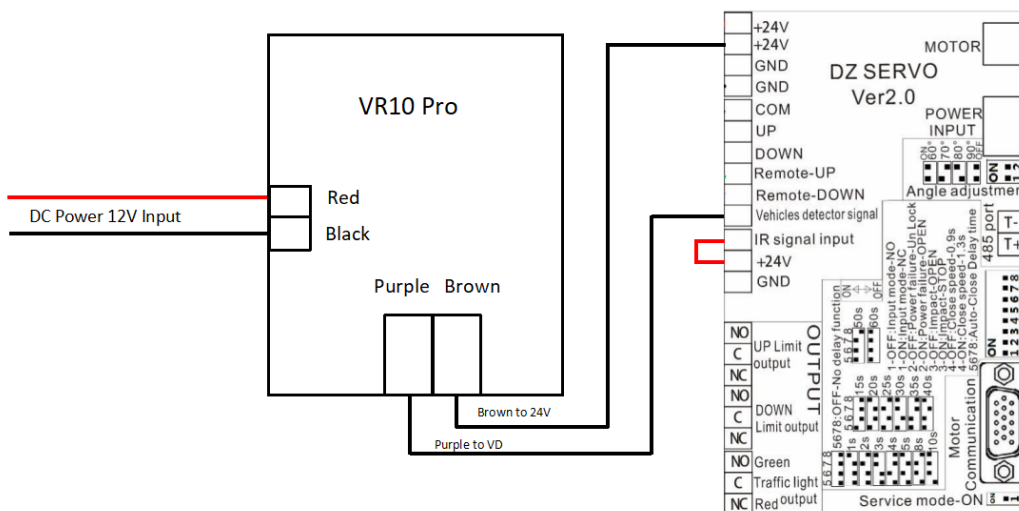

Radar connected to ProBG series barrier gate

## 8 Debug Radar with App (Radar Assistant)

### 8.1 Download and Install the App to the Phone

1. If the system of phone is android, scan the QR code using the browser, downloading and installing the application.



QR code for android phone

2. If the system of phone is iOS, go to the App Store and search "Radar Assistant" for downloading it.

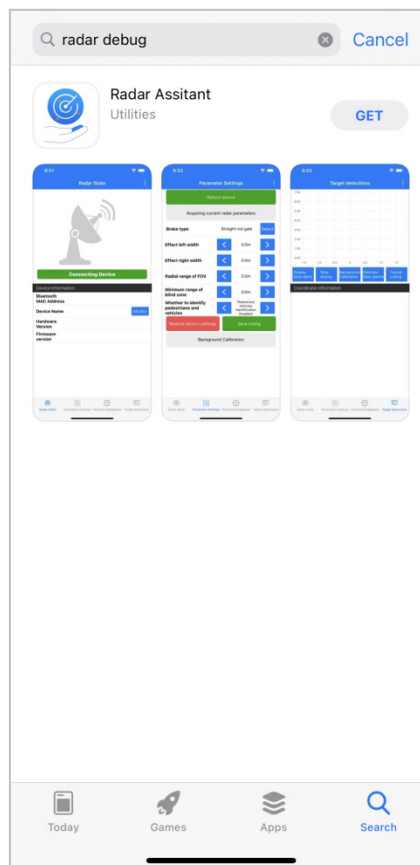



## 8.2 Connect to Bluetooth

1. Click the **[Once]** or **[Allow only while using the app]** button to access the application.

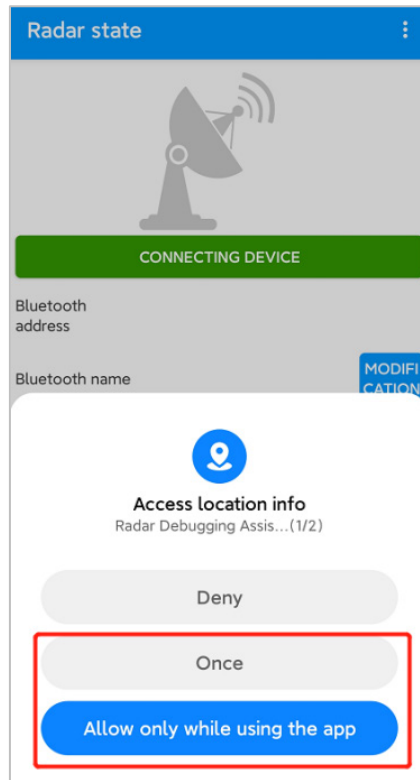

2. Open the Bluetooth of the phone, and click **[CONNETING DEVICE]** to connect the Bluetooth of radar.

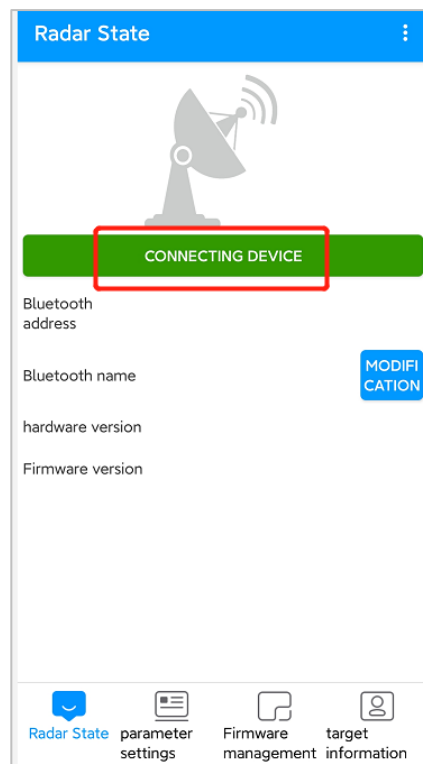
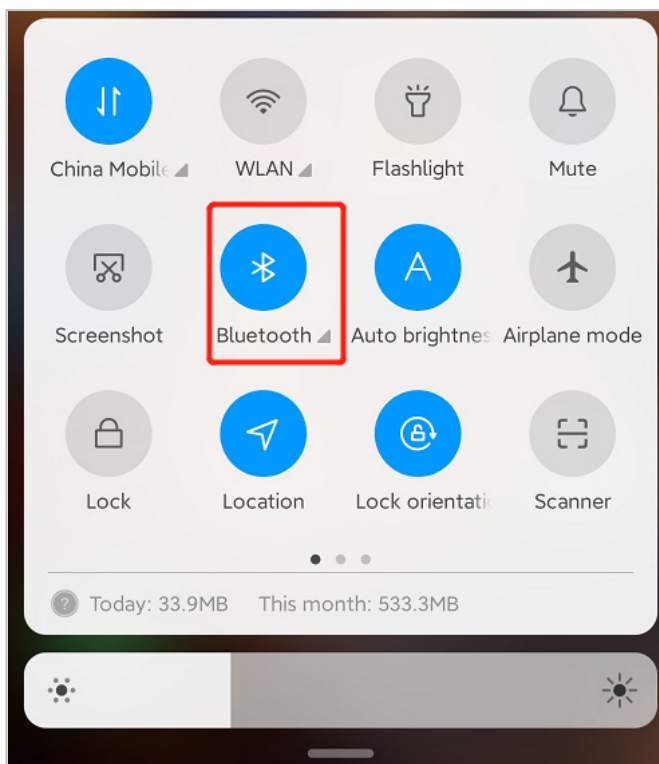

- Choose the Bluetooth and enter the password "88888888" to connect it. Once the Bluetooth connected, the icon will turn green. The name of Bluetooth can also be changed and Bluetooth can be disconnected.

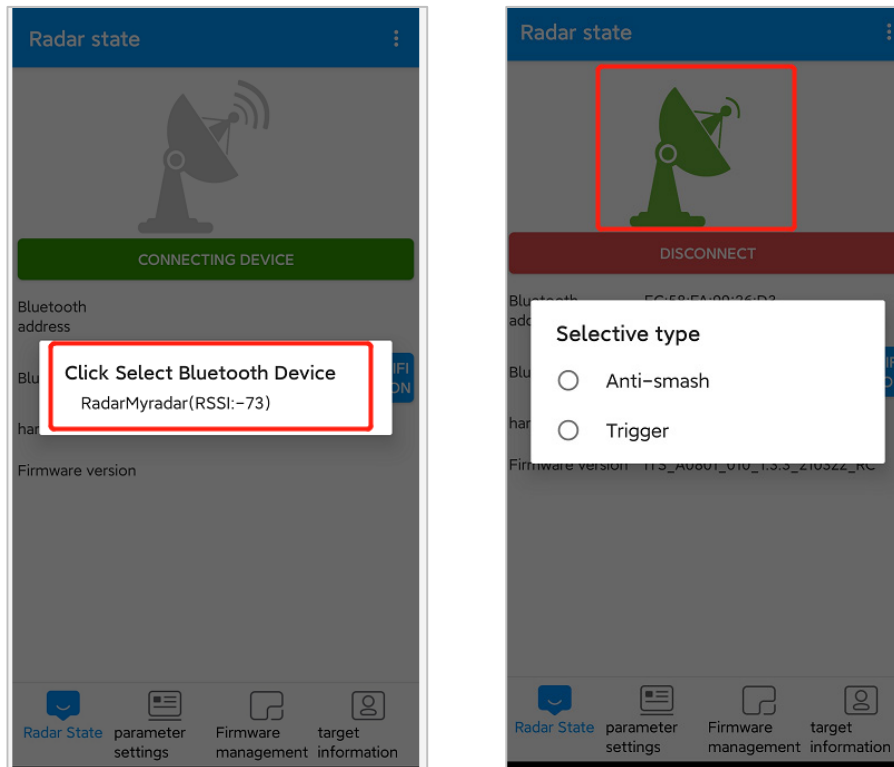

### 8.3 Set Parameter for Radar

Enter the parameter setting interface of anti-smash mode, select the straight boom gate type first, as the pictures shown below.

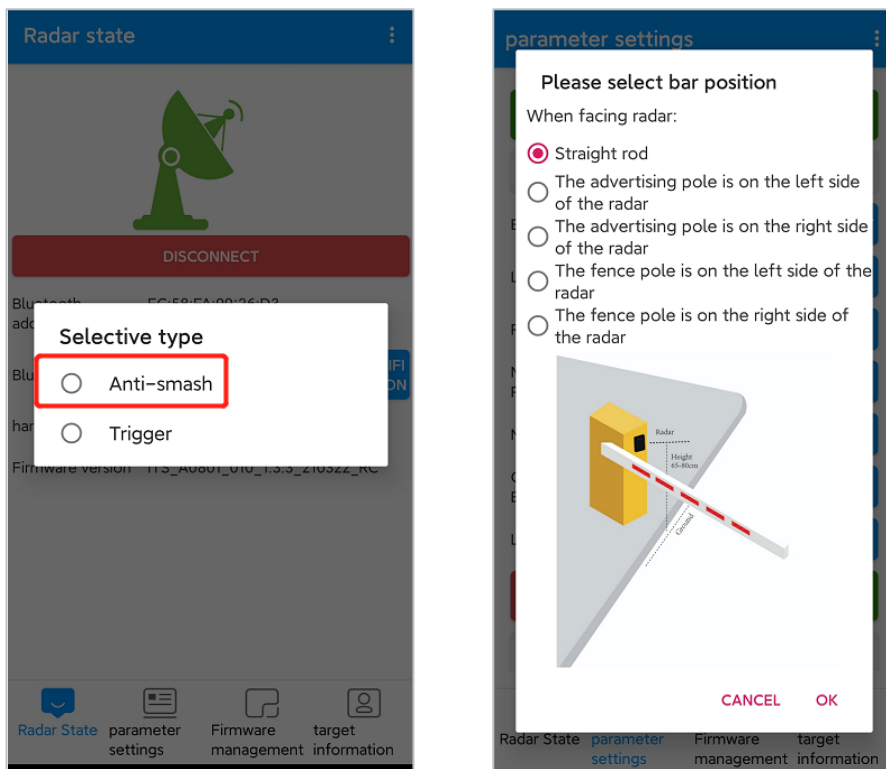

Use the left and right button to adjust the parameter value. Long press the button can quickly adjust the parameter value.

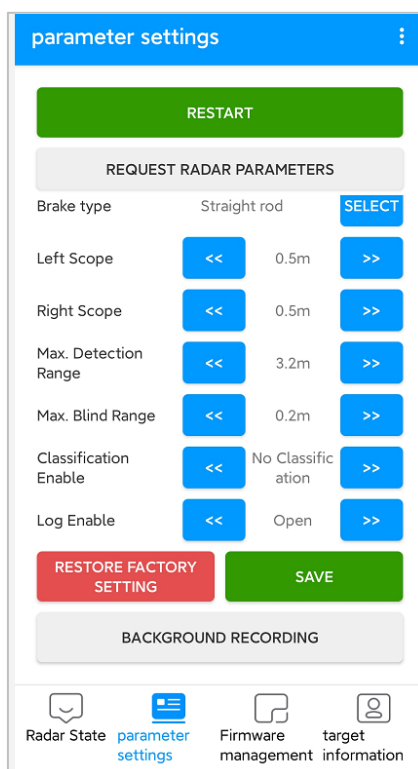

**Brake Type:** There are three types of boom, straight boom, advertising boom and fence boom, by default, we choose the straight boom.

**Left Scope:** The left scope of the radar detection area, values between 0.5m to 1.5m can be set.

**Right Scope:** The right scope of the radar detection area, values between 0.5m to 1.5m can be set.

**Max. Detection Range:** The distance of radar detection area, values between 1m to 6m can be set.

**Max. Blind Range:** The distance in front of the radar that will not be detected by radar, for example, if the value is set as 0.4m, object 0.4m from radar will not be detected. Values between 0.2m to 1m can be set.

**Classification Enable:** There are three modes to be choose, and we choose the first one **[No Classification]** by default.

- **No Classification:** This mode means that the radar will detect the vehicles and pedestrians passing by the radar detection area.
- **Pedestrians/Vehicles Classification:** This mode means that the radar will detect both the vehicles and pedestrians passing by the radar detection area for the first time. But after waiting for 6-7 seconds, the pedestrians can not be detected by radar any more.
- **Recognition of Electrical Motorbikes:** This mode means that only motorbikes will be detected by radar.

**Log Enable:** If choose **[Open]**, the log of radar will be saved on the App.

**Restore Factory Setting:** Click this button and all the parameters of radar will be restore to the factory parameter.

**Save:** Click **[SAVE]** to make parameter setting effective.

**Background Recording:** Click this button to do background learning for radar.

**Restart:** Click this button to restart the radar.

**Request Radar Parameters:** Get all the current parameters of radar.

## 8.4 Background Recording

Background learning must be done before the target information display.

**The type of barrier boom is straight.** The background learning steps are as follows:

1. Keep the barrier boom in a raised state;
2. Click **[BACKGROUND RECORDING]** on the App;
3. Wait for about 3 seconds to let radar automatically finish the learning process;
4. Restart the radar and disconnect the Bluetooth.

**The boom type is a fence boom/advertisement boom/airborne gate,** and the background learning steps are as follows:

1. Keep the barrier boom in a raised state;
2. Click **[BACKGROUND RECORDING]** on the App;
3. Wait for about 30 seconds to 60 seconds, during the period, use a remote to make barrier boom arm go up and down until the learning process is finished;
4. Restart the radar and disconnect the Bluetooth.

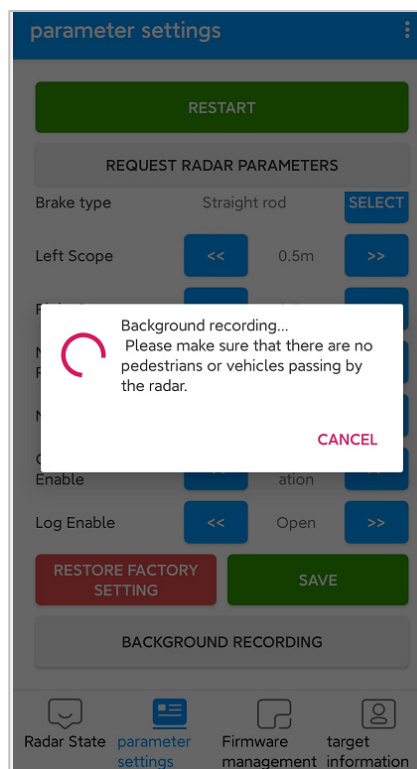
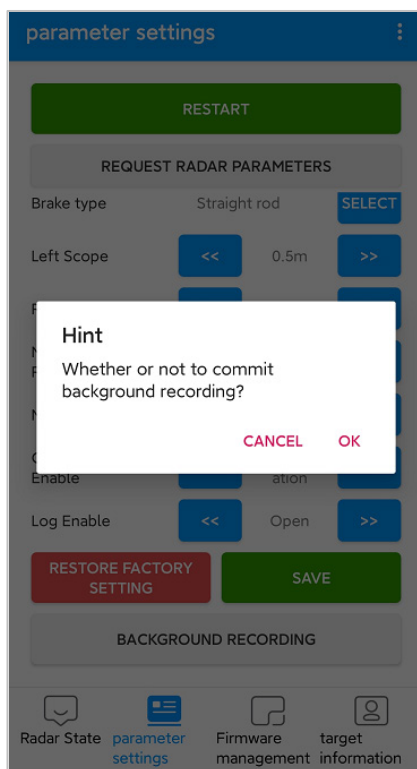

**Note:** During background learning, ensure that there are no movable targets (vehicles, people) other than the fixed environment within the radar detection range.

## 8.5 Display of Target Information

1. After the background learning is completed, you can click to display the target information. During this process, please do not perform other operations except stop the display.

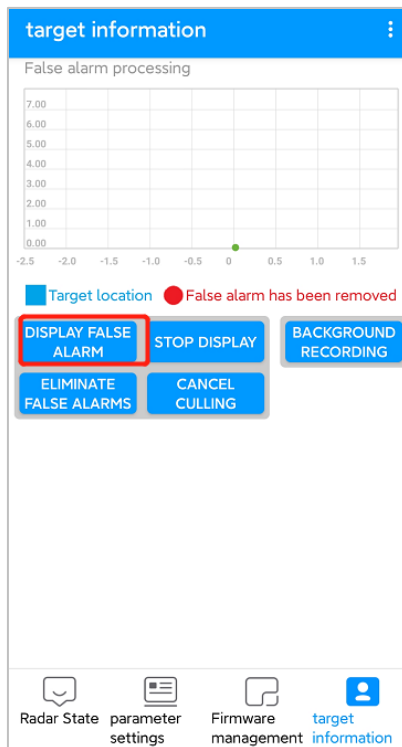

2. If there is false alarm on the interface, click **[STOP DISPLAY]** and then click **[ELIMINATE FALSE ALARM]**. After Eliminate false alarm, it can be used normally.

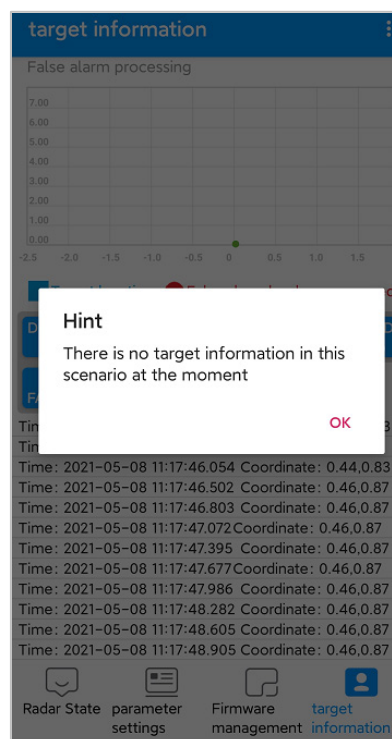
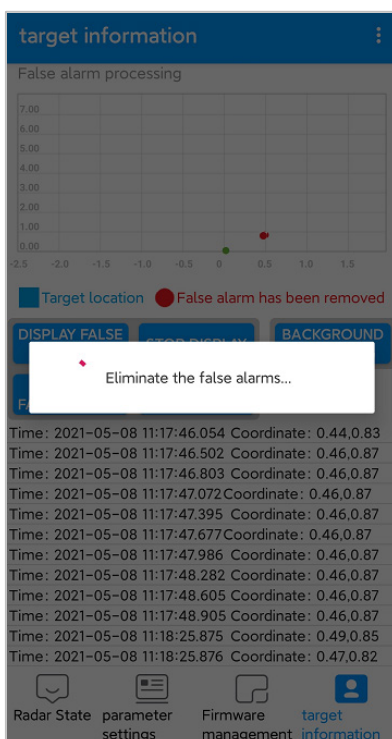
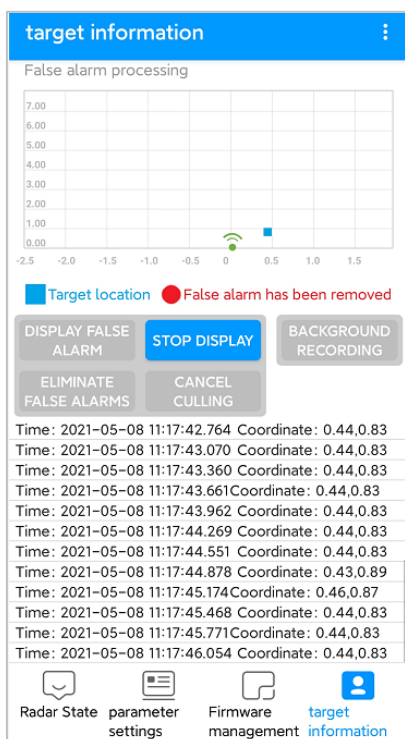

## 9 Debug Radar with Software

### 1. Select the port

Insert the 485 module on the host computer to establish a connection with the radar module. Find the port number in the computer's device manager list and select it.

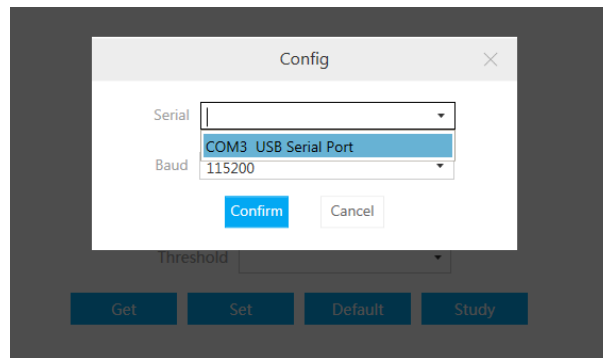

### 2. Set the detection area, boom type, and sensitivity (the high sensibility by default).

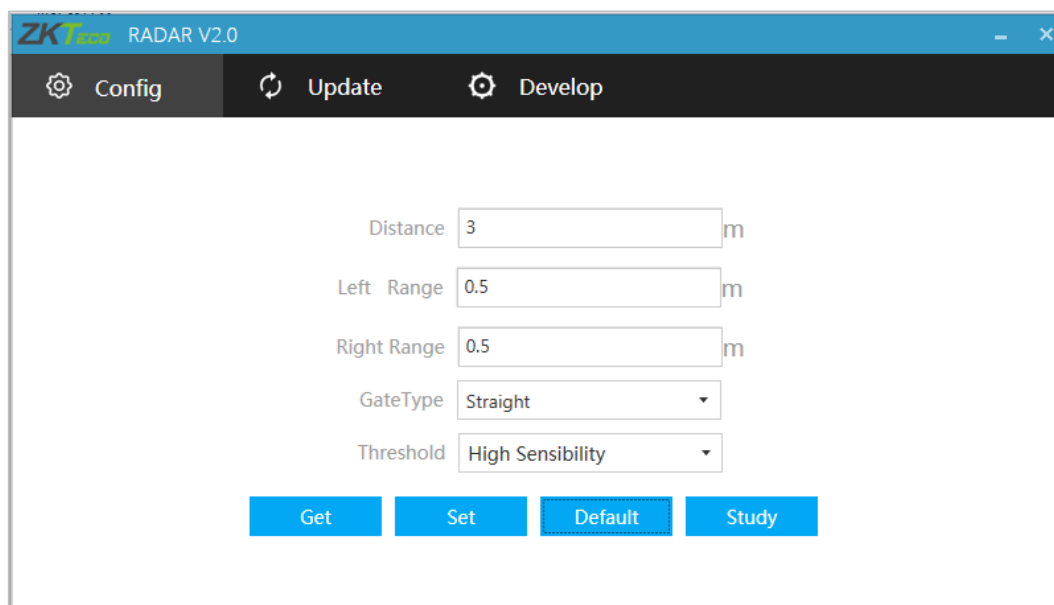

As shown in the figure above:

**Distance:** Set the radar monitoring distance.

**Left Range, Right Range:** Set the radar monitoring left range and right range.

**Gate Type:** Set the boom type of the barrier.

**Threshold:** Set the detection sensibility.

- High Sensibility supports anti-smashing and dropping boom (When people and vehicles leave the radar detection area) for people and vehicles.
- Medium Sensitivity supports anti-smashing and dropping boom for vehicles, supports anti-smashing for people.
- Low Sensitivity supports anti-smashing and dropping boom for vehicles.

**Get:** Get current radar parameters.

**Set:** Save the radar parameters to make the settings effective.

**Default:** The radar parameters are restored to the factory state. The default sensibility is high sensibility, the default detection distance is 3m, and the left and right are 0.5m, the detection area is as shown in the figure.

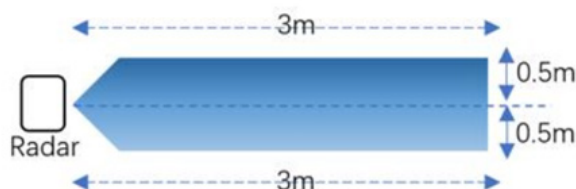

### 3. Background learning

**The type of barrier boom is straight.** The background learning steps are as follows:

- Keep the barrier boom in a raised state;
- Power on the radar and click **[Study]** on the software;
- The straight boom will remain motionless and the light remains unchanged;
- Power off the radar and restart it.

**The boom type is a fence boom/advertisement boom/airborne gate,** and the background learning steps are as follows:

- Keep the barrier boom in the raised state;
- Turn on the radar power supply, and click **[Study]** on the software;
- The barrier boom will fall automatically, stand behind the radar next to the barrier and observe the radar green indicator light (or stand outside the long distance of the boom set opposite the radar), the radar green light will flash quickly;



- (d) Wait for 3S after the boom is completely stabilized, use the barrier remote control to raise and lower it repeatedly for about three minutes until the green light is always on, indicating that the environmental record is complete;
- (e) The radar can be used after power off and restart.

**Note:** During background learning, ensure that there are no movable targets (vehicles, people) other than the fixed environment within the radar detection range.

## 10 FAQ

- **Problem:** After installation, the green light of the radar is always on, and the boom does not fall.

Possible cause: The Newly added strong reflector in the radar detection range needs to be moved out of the radar field of view or re-learned for background learning.

- **Problem:** The person is standing in front of the radar and the green light is not on.

Possible cause: The radar starts to detect the difference between people and vehicles after the car triggers the radar light.

- **Problem:** The red light of radar flashes when the 12V power supplied by the gate control board is on.

Possible cause: It is recommended to connect an external 12V-1A power adapter.

## 11 Packing List

Number	Accessories	Quantity
1	VR10 Pro Radar	1
2	M16 Nut	1
3	Gasket	1
4	Rubber Waterproof Ring	1
5	Wiring Harness	1
6	User Manual	1

ZKTeco Industrial Park, No. 32, Industrial Road,

Tangxia Town, Dongguan, China.

Phone : +86 769 - 82109991

Fax : +86 755 - 89602394

[www.zkteco.com](http://www.zkteco.com)

