

# PIR Sensor Stair Light Controller

## Model No.: ES32

PIR sensor / Daylight Sensor / Max 32 steps / Compatible with 27 kinds of chips / Max 960 pixels / OLED display

### Features

- Multifunctional PIR sensor stair light controller features daylight sensor.
  - 32 channels constant voltage output drive low voltage LED strip, Max. 1A current per channel.
  - 2 groups SPI(TTL) signal output, drive 27 kinds IC digital RGB LED strip, IC type and R/G/B order can be set.
- Compatible ICs: TM1803, TM1804, TM1809, TM1812, UCS1903, UCS1909, UCS1912, UCS2903, UCS2909, UCS2912, WS2811, WS2812, TM1829, TM1914A, GW6205, GS8206, GS8208, LPD6803, LPD1101, D705, UCS6909, UCS6912, LPD8803, LPD8806, WS2801, WS2803, P9813, SK9822.
- Easy operation with OLED display and 3 buttons.
  - four work light modes selectable.
  - Two stair light controllers can cascade.
  - Built-in multiple color mode, speed and brightness 1-8 grade adjustable.
  - Push switch can be used as induction signal input.
  - With fast self-testing function.
  - Any damaged LED channel in 32 channels can be set disable.

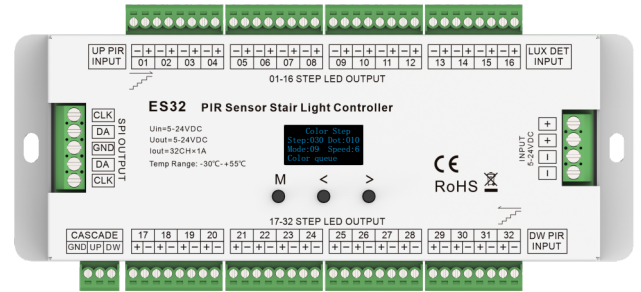

### Technical Parameters

Input and Output		Safety and EMC		Sensor data	
Input voltage	5-24VDC	EMC standard (EMC)	ETSI EN 301 489-1 V2.2.3 ETSI EN 301 489-17 V3.2.4	Sensitive field	≤3m
Output voltage	32 x (5-24)VDC	Safety standard(LVD)	EN 62368-1:2020+A11:2020	Sensitivity angle	120
Output current	32CH, 1A/CH	Certification	CE, EMC, LVD	Environment	
Output power	32 x (5-24)W	Package		Operation temperature	Ta: -30°C ~ +55°C
Output type	Constant voltage + SPI(TTL)	Size	L205 x W130 x H45mm	Case temperature (Max.)	Tc: +85°C
Warranty		Gross weight	0.52kg	IP rating	IP20
Warranty	5 years				

### Mechanical Structures and Installations

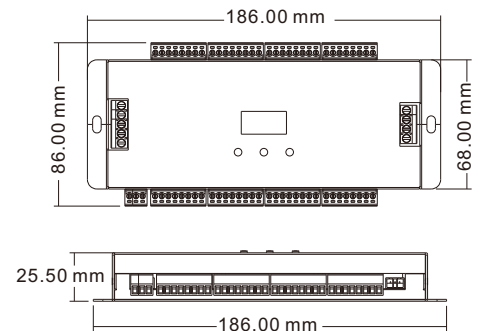
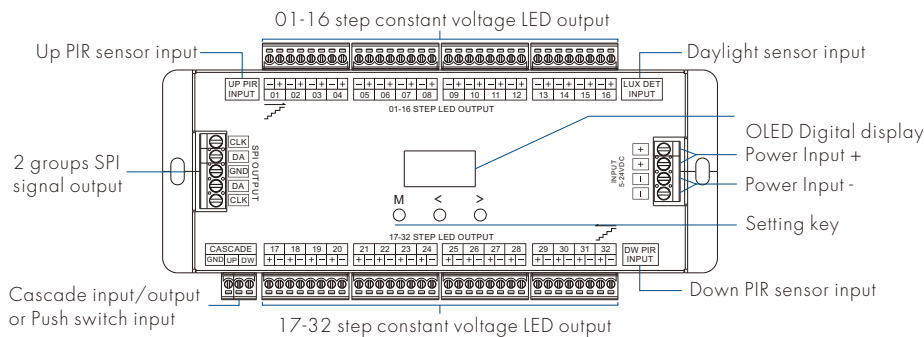

### Wiring Diagram

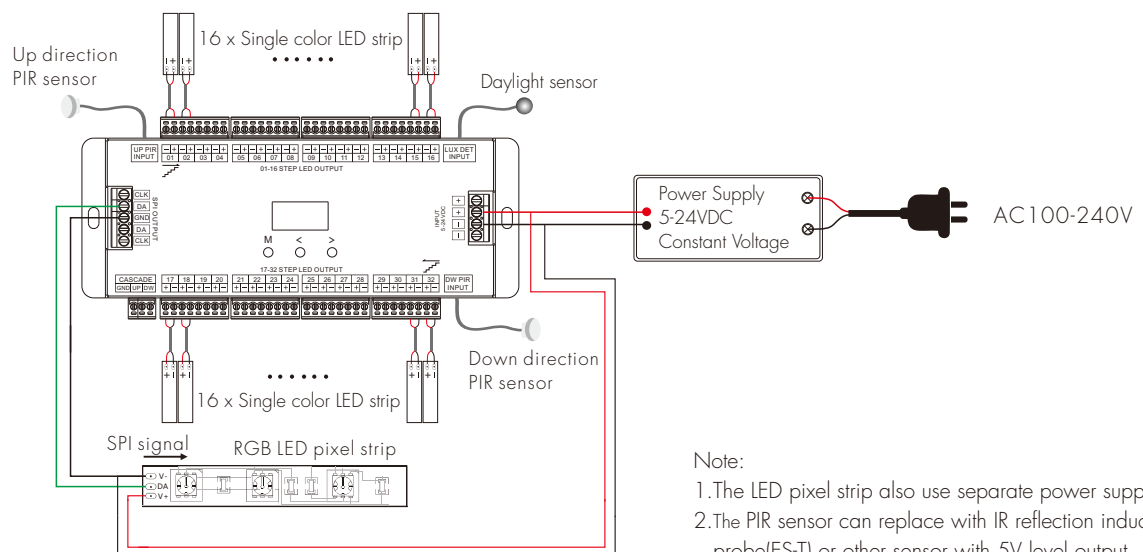

- Note:
1. The LED pixel strip also use separate power supply.
  2. The PIR sensor can replace with IR reflection induction probe(ES-T) or other sensor with 5V level output.

## OLED screen and key operations

1. Long press M key for 2s, enter system parameters setting state, to switch four work light modes, set light off mode, push switch input function, chip type and RGB order or daylight sensor threshold.
2. Short press M key, enter current work light mode parameters setting state.
3. When in parameters setting state, short press M key to switch multiple parameters, press < or > key for parameters' adjustment.
4. Long press M key or wait 15s to quit parameter setting state.
5. Long press M & > key for 2s, display "Light up test" on the fourth line of OLED screen, start up direction induction light testing.
6. Long press M & < key for 2s, display "Light down test" on the fourth line of OLED screen, start down direction induction light testing.
7. Long press < & > key for 2s, restore factory default parameters, jump to language interface automatically, press < or > to switch two languages(Chinese and English), the language which is selected will blink, press M key to exit language interface.
8. Long press <, > & M for 2s, enter 32 channels LED disable setting interface.
9. When work in White Step/Color Flow/Color Step/White Step + Color Flow mode, the fourth line display color mode name. When the controller is in induction state, OLED screen will display light on/off state or induction signal input prompt ("Light up start" and "Light down start").  
If the current detected LUX value is smaller than daylight sensor threshold, display "Light up off" or "Light down off" on the fourth line.



Language interface



Light on/off state on the fourth line

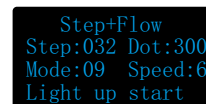

Induction signal input prompt on the fourth line

## System parameters setting

**Out:** Switch four work light modes.

**White\_Step:** Only multiple constant voltage LED strip light mode.

**Color\_Flow:** Only 1 or 2 straight line digital pixel LED strip light mode.

**Color\_Step:** Only multiple Z-shape digital pixel LED strip light mode.

**Step+Flow :** Multiple constant voltage LED strip + 1 or 2 straight line digital pixel LED strip light mode.

**Chip:** Select one chip type from ten options (shown in below table) one of these from 6 RGB orders (RGB,RBG,GRB,GBR,BRG,BGR). The parameters are valid only for the work modes with SPI signal output.

**Def RGB:** RGB hex value for user-define color. The parameters are valid only for the work modes with SPI signal output.

**LuxSet:** Daylight sensor threshold (10, 30, 50, 100, 150, 200lux,OFF), with sufficient ambient light, the PIR sensor does not turn on the light.  
The digital value after \* is current detected LUX value.

**OFF:** Set the way of turning off light when the induction control process finished.

**Delay sync:** Turning off the light at the same time after the delay time.

**One by one:** Turning off the light one by one from head to tail.

**Push:** Switch two kinds of push switch input modes.

**Cascade:** The push switch input work as cascade input/output or simulated PIR inductive input.

**All-on:** The push operation will turn on all light and turn off synchronously after the delay time.

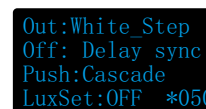

System parameters interface of White step mode



System parameters interface of White step + Color flow mode

## Digital pixel RGB LED strip compatible IC types list:

IC type	Compatible IC type	Output signal
TM1809	TM1804, TM1812, UCS1903, UCS1909, UCS1912, UCS2903, UCS2909, UCS2912, WS2811, WS2812	DATA
TM1829		DATA
TM1914A		DATA
GW6205		DATA
GS8206	GS8208	DATA
LPD6803	LPD1101, D705, UCS6909, UCS6912	DATA, CLK
LPD8803	LPD8806	DATA, CLK
WS2801	WS2803	DATA, CLK
P9813		DATA, CLK
SK9822		DATA, CLK

## LED channel output disable setup

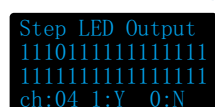

ch: the channel which is set  
1: enable the channel to work  
0: disable the channel

**For example:** If the fourth channel output is damaged, please long press M, < & > key to enter LED disable interface, then change the corresponding channel(04) from 1(on) to 0(off), namely the damaged channel can be ignored.

## 1. White Step mode (Constant voltage LED strip light mode)

```
White Step
Step:032 Bri:8
Mode:01 Speed:6
ON one by one
```

**Step:** Total step number, 008-032  
**Mode:** White mode number, 01-04  
**Bri:** Brightness grade,  
 1-8, 8 is the brightest level.  
**Speed:** Speed grade,  
 1-8, 8 is the fastest speed.

White mode list:

No.	Name
01	ON one by one
02	All OFF, Five ON
03	All ON, one OFF
04	All ON

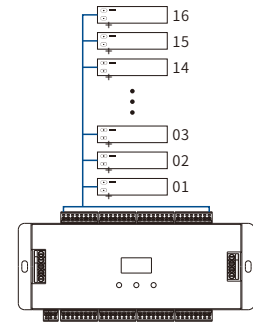

## 2. Color Flow mode (Straight line digital pixel LED strip light mode)

```
Color Flow
Dot: 300 Bri:8
Mode:09 Speed:6
Color queue
```

**Dot:** Pixel dot number, 032-960  
**Mode:** Color mode number, 01-12  
**Bri:** Brightness grade,  
 1-8, 8 is the brightest level.  
**Speed:** Speed grade,  
 1-8, 8 is the fastest speed.

Color mode list:

No.	Name
01	Red
02	Orange
03	Yellow
04	Green
05	Cyan
06	Blue
07	Purple
08	White
09	Color queue (7 color + White)
10	Color chase (7 color + White)
11	Color fade (6 color flow)
12	Rxxx Gxxx Bxxx (User define)

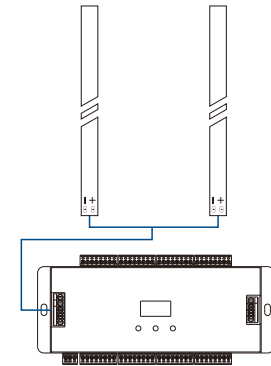

## 3. Color Step mode (Z-shape digital pixel LED strip light mode)

```
Color Step
Step:030 Dot:010
Mode:09 Speed:6
Color queue
```

**Step:** Total step number, 008-160  
**Dot:** Pixel dot number of each step, 002-120  
 The Step number x Dot number must < 960  
**Mode:** Color mode number, 01-12  
**Speed:** Speed grade,  
 1-8, 8 is the fastest speed

Color mode list:

No.	Name
01	Red
02	Orange
03	Yellow
04	Green
05	Cyan
06	Blue
07	Purple
08	White
09	Color queue (7 color + White)
10	Color chase (7 color + White)
11	Color fade (6 color fade)
12	Rxxx Gxxx Bxxx (User define)

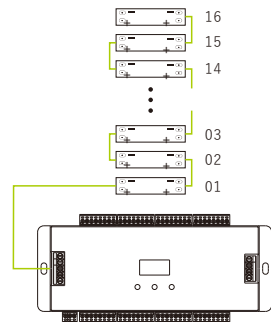

## 4. White Step + Color Flow mode (Constant voltage LED strip + Straight line digital pixel LED strip light mode)

```
Step+Flow
Step:032 Dot:300
Mode:09 Speed:6
Color queue
```

**Step:** Total step number, 008-032  
**Dot:** Pixel dot number, 032-960  
**Mode:** Color mode number, 01-12  
 The mode number is for straight line digital pixel LED strip only.  
 The mode for constant voltage LED strip is fixed on one by one.  
**Speed:** Speed grade,  
 1-8, 8 is the fastest speed.

Color mode list:

No.	Name
01	Red
02	Orange
03	Yellow
04	Green
05	Cyan
06	Blue
07	Purple
08	White
09	Color queue (7 color + White)
10	Color chase (7 color + White)
11	Color fade (6 color flow)
12	Rxxx Gxxx Bxxx (User define)

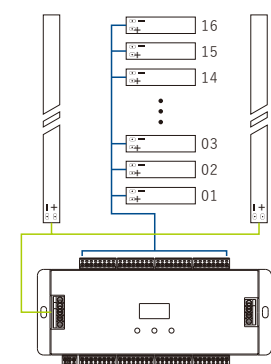

## Two stair light controller cascade connection

The downstairs light controller connects Up direction PIR sensor and daylight sensor. The upstairs light controller connects Down direction PIR sensor and daylight sensor. Two stair light controllers connect cascade UP/DW line. When induction light control process is over, the light will turn off after 10s automatically. For speed 1-8 level(cascade input), the turn off delay time is 90/80/70/60/50/40/30/20s respectively.

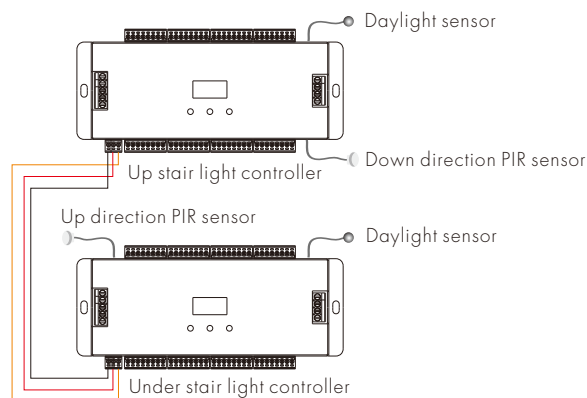

Note:the push switch function must be set as cascade input.

## Two Push switch as up/down induction signal input connection

The under push switch connect cascade UP port of the stair light controller. The up push switch connect cascade DW port of the stair light controller. The push switch operation will ignore daylight sensor threshold setting.

When the push switch function be set as cascade input/output, the push operation will start induction light control process.

When the push switch function be set as button input, the push operation will turn on all light, and the light will turn off after 20s automatically. For speed 1-8 level, the turn off delay time is 90/80/70/60/50/40/30/20s respectively.

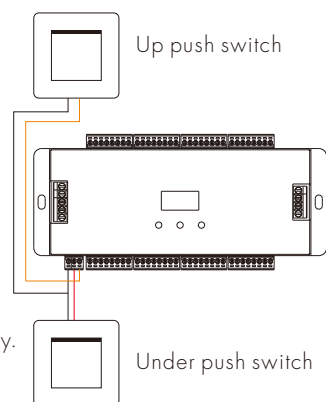

## Installation of PIR sensor

Size of detector:

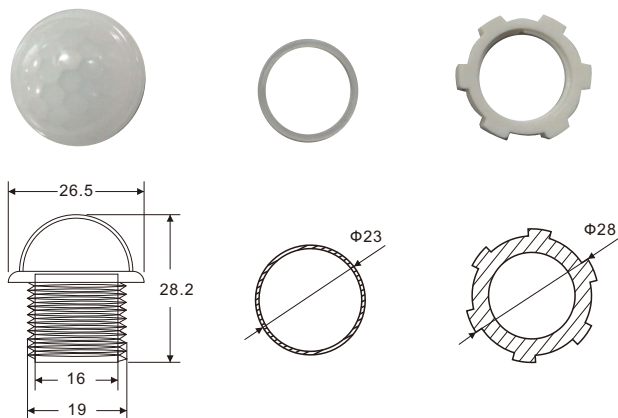

PIR sensor detection pattern:

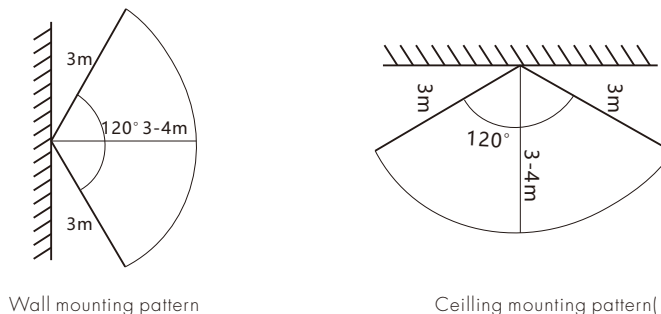

## Notice for installation of PIR sensor

1. If the sensor is exposed to direct sunlight, interference signal will be introduced.
2. The sensor should be installed in a dry environment and keep away from windows, air conditioner and fans.
3. Make sure that the sensor stays away from heat source, such as countertops, kitchen appliances which generate hot steam, walls and windows in direct sunlight, air conditioner, heating, refrigerators, stoves and so on.
4. We recommended that wall-mounted installation height is 1-1.5 meters and that ceiling mounting height is no more than 3 meters.
5. There should not be shelter (screen, furniture, large bonsai) within the range of detection.

## Packing List



LED Controller  
1 pcs



User Manual  
1 pcs



Daylight sensor  
(30cm)  
1 pcs



PIR sensor  
2 pcs



PIR sensor  
extension line (5m)  
2 pcs