

Godox

微距闪光灯  
Macro Flash

MF12



深圳市神牛摄影器材有限公司

地址: 深圳市宝安区福海街道塘尾社区耀川工业区厂房2栋  
电话: 0755-29609320(8062) 传真: 0755-25723423 邮箱: godox@godox.com

GODOX Photo Equipment Co., Ltd.

Add: Building 2, Yaochuan Industrial Zone, Tangwei Community, Fuhai Street, Bao'an District,  
Shenzhen 518103, China Tel: +86-755-29609320(8062) Fax: +86-755-25723423  
E-mail: godox@godox.com

godox.com

Made in China

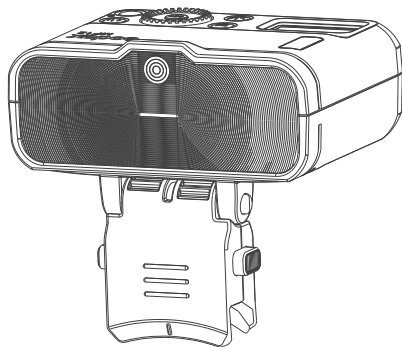

说明手册  
Instruction Manual

# 目录

02	前言
03	警告
04	部件名称
	机身
	控制面板
	OLED显示屏
06	标配物品
06	可选购附件
09	电池
09	电源管理
10	造型灯
10	闪光模式选择
	TTL自动闪光模式
	M手动闪光模式
12	无线电(2.4G)传输
14	C.Fn: 设置自定义功能
14	复位功能
14	强制关机功能
14	热保护功能
15	规格参数
16	维修保养

## 前言

感谢您购买神牛产品!

MF12是一款迷你微距自动闪光灯。

**功能上**, MF12配备了两种闪光模式: TTL模式和M(手动)闪光模式。

具备了S1/S2两种光控引闪方式, 勿需额外指令信号或者外置遥控, 直接触发闪光, 方便省事。灯头处搭载常亮LED造型灯, 随时创造造型光, 可用作背景灯或者照明。

**结构上**, MF12采纳专业光学透镜设计, 聚集作用更强, 更能确保拍摄光效均匀分布。机身内置锂电池, 充电即可使用, 方便户外拍摄、旅拍使用。机身小巧轻便, 操作界面简单易懂, 可放进口袋, 随身携带。此迷你闪光灯常应用于动植物、美食、珠宝、口腔影像等微距拍摄。

### 主要特点:

- 配备TTL模式和M手动闪光模式(MF12仅离机使用)
- 具备S1/S2光控引闪方式
- 搭载常亮LED造型灯
- 选用专业光学镜片, 出光更加均匀
- 内置2.4G无线: 可以远距离控制灯体
- OLED液晶屏: 显示界面清晰美观
- 内置锂电池, 采用通用TYPE-C充电口
- 全功率约500次闪光, 1.7秒快速回电。

## 警告

- ▲ 请保持干燥。
- ▲ 请勿私自拆卸产品,如产品出现故障须由本公司或授权的维修人员进行检查维修。
- ▲ 请勿让儿童接触本产品。
- ▲ 禁止拆卸、撞击、挤压或投入火中,若出现严重鼓胀,请勿继续使用。请勿放置在超过50度的高温环境中。
- ▲ 请勿将闪光灯头正对人眼闪光(特别是婴儿的眼睛),否则可能会在短时间内造成视力障碍。
- ▲ 请勿在化学品、可燃性气体或其他特殊物质附近使用闪光灯,这些物质在特殊情况下可能对闪光灯发出的瞬间强光敏感,有可能导致火灾或电磁干扰。在这些场合下,请注意相关警告标识。
- ▲ 本产品不能防水,在雨天及潮湿的环境下注意防水。
- ▲ 若发生任何故障,请立即关闭闪光灯电源。

## 部件名称

### · 机身

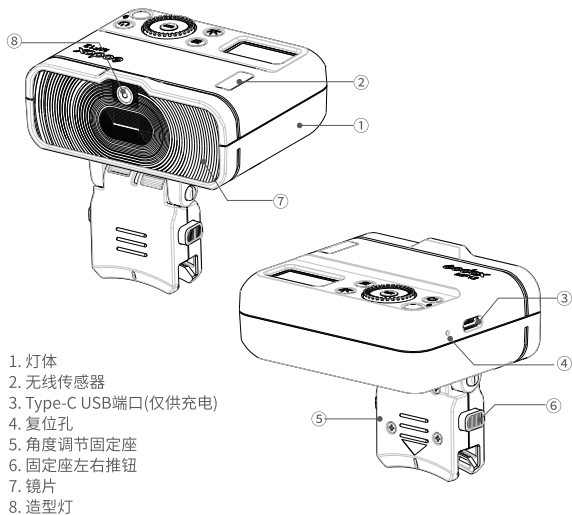

1. 灯体
2. 无线传感器
3. Type-C USB端口(仅供充电)
4. 复位孔
5. 角度调节固定座
6. 固定座左右推钮
7. 镜片
8. 造型灯

## 部件名称

### • 控制面板

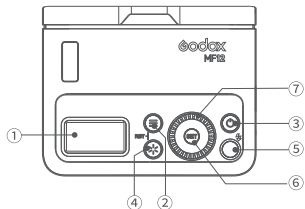

1. 显示屏
2. 菜单按键
3. 电源开关键
4. 造型灯按键
5. 试闪按键
6. SET按键
7. 调节旋钮

### • OLED显示屏



TTL模式

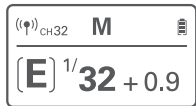

M手动闪光模式

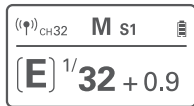

S1/S2

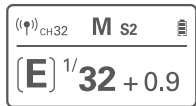

## 标配物品



注:MF12双灯套装中的物品,除了上述物品,还有安装环MF-AR\*1,适配环套装(八个适配环49mm、52mm、55mm、58mm、62mm、67mm、72mm、77mm)等装备。

## 可选购附件

可搭配本公司以下摄影附件使用,以获得最佳的拍摄效果和使用体验:  
XPro、X1 TTL引闪器、X2 TTL引闪器、安装环MF-AR、适配环套装(49mm、52mm、55mm、58mm、62mm、67mm、72mm、77mm)。



## 附件安装

### • 如何安装冷靴座

1. 按住MF12固定座左右推钮，将冷靴座一端对准固定座一端进行滑动，听到“咔”声表示装到位。
2. 再将冷靴座插入相机上的热靴，并转动热靴锁环，将其锁紧即可。

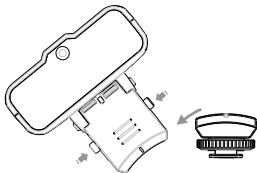

### • 如何使用安装环(需另购)

1. 将MF12的固定座口(有箭头面)对准安装环MF-AR上的滑动块，按压滑动块推进，听到“咔”声表示装到位。

一个安装环可安装6个灯。

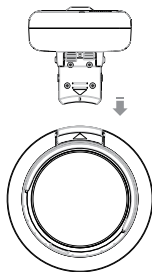

2. 按住固定座左右推钮，MF12可在安装环上左右旋转。

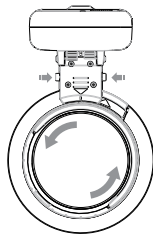

3. 再选择与相机镜头颈圈相符的适配环(8种规格 49mm、52mm、55mm、58mm、62mm、67mm、72mm、77mm)(需另购)，将相机镜头适配环套在安装环上。

4. 将环安装在相机镜头上固定好即可。

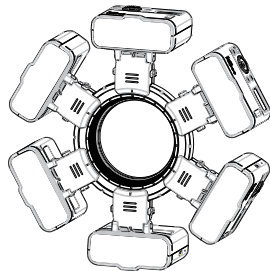

## 电池

### • 特性:

1. 本品采用锂电池,集成在产品里面不可拆卸,使用寿命长。
2. 安全可靠,内置电路有过充保护、过放保护、过流保护、短路保护。
3. 使用Type-C USB接口充电,一小时内(约55分钟)能充满电。

### • 电池电量指示:

电量符号显示	意义
3格	满电
2格	中电
1格	低电
无格	电量少,请及时充电
屏幕显示此图标 	电量用尽,此状态不支持闪光灯工作,10秒后将自动关机。 注:此状态请尽快(10天内)充电,才可使用或放置。

## 电源管理

电源开关控制该产品的打开和关闭,长时间不使用时请关闭电源。

### 自动关机模式设置

按下菜单按键,旋转调节旋钮选择STBY,按SET按键,再旋转调节旋钮进行选择30min/60min/90min/OFF.设置自动关机后,超过(30/60/90分钟)无人操作,闪光灯会自动关机。自动关机时请按电源开关按键唤醒,开机动画出现,滑动调节旋钮即可操作。



注:离机使用时,建议进入菜单C.Fn-STBY,关闭自动关机功能。

## 造型灯

### 1. 开关造型灯:

- 1.1. 短按造型灯按键< >控制LED造型灯的打开和关闭。
- 1.2. 长按造型灯按键进入造型灯设置界面时,短按SET按键也能控制造型灯的打开和关闭。

### 2. 造型灯设置:长按< >进入造型灯设置界面。

- 2.1. 亮度设置:选择调节旋钮设定亮度值,亮度等级10级(1~10)。

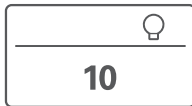

## 闪光模式选择

MF12闪光灯有TTL模式、M(手动)闪光2种模式。

在TTL模式下,相机的测光系统会侦查从主体反射回来的闪光照明,从而自动调节闪光输出量,使主体和背景得到均衡曝光。所以无论背景的光度如何,拍摄对象均可以正确地曝光。当你想强调拍摄对象或作出曝光补偿时,选择TTL模式,这会对你有所帮助。在M(手动)闪光模式下,你要选择光圈和闪光输出量。当你很难从自动闪光模式中获得准确曝光来拍摄对象时,利用这个模式,你便可控制曝光和闪光的拍摄距离。

短按菜单按键< >,旋转调节旋钮至MODE,接着短按SET按键,最后旋转调节旋钮选择TTL模式或M(手动)闪光模式。

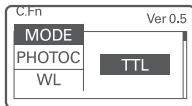

### • TTL自动闪光模式

选择TTL,再按菜单按键< >返回主界面,闪光灯进入TTL自动闪光模式。

## • M手动闪光模式

您可以在1/128功率至1/1全功率间, 每档以0.1为增量设置闪光输出。

1. 选择M, 再按菜单按键 $\langle \text{MENU} \rangle$ 返回主界面, 闪光灯进入M手动闪光模式。
2. 在M模式主界面, 旋转调节旋钮可进行设置闪光输出功率。

为获得正确的闪光曝光, 请使用手持的闪光测光表确定所需的闪光输出。

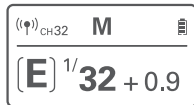

## • 光控引闪(PHOTOC)设置

在M手动闪光设置下, 按菜单按键 $\langle \text{MENU} \rangle$ 进入菜单C.Fn, 旋转调节旋钮选择PHOTOC, 按SET按键, 再旋转调节旋钮进行选择S1或S2功能。

### 1. S1光控同步引闪设置

选择S1功能, 闪光灯可作为副灯使用, 创造多种照明效果, 适用于手动闪光环境。它会与主闪光灯的第一次闪光同步触发闪光, 效果与使用无线引闪器一致。

### 2. S2光控预防引闪设置

选择S2功能, 闪光灯可作为副灯使用, 适用于TTL闪光环境。具有预防闪功能, 使用带一次预防功能的相机能用光控实现同步拍摄。它会与主闪光灯的第二次闪光同步触发闪光, 即2次光控引闪。

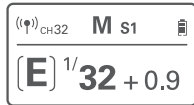
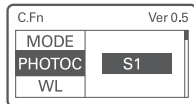

**▲ 只有在M模式下才支持S1/S2光控引闪模式。**

## 无线电(2.4G)传输

MF12使用神牛2.4G无线X系统, 可以与本厂X1、XPro、X2触发器完美结合使用。作为从属单元, 可兼容佳能/尼康/索尼/松下/奥林巴斯/富士TTL系统, 根据主控单元自动切换, 无需手动设置。尼康相机(使用X1T-N)和佳能相机(使用X1 T-C)和索尼相机(使用X1T-S等)可同时同地共享一台或多台MF12-TTL, 无缝结合, 无懈可击!

## • 无线(WL)设置

按菜单按键 $\langle \text{MENU} \rangle$ 进入菜单C.Fn, 旋转调节旋钮选择无线WL, 按SET按键, 再旋转调节旋钮进行选择: OFF为关闭无线功能, ON为打开无线功能。

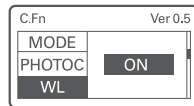

## • 频道(CH)设置

如果在拍摄现场不止一个无线闪光系统, 您可以通过更改通讯频道来防止信号干扰。保证主控单元和从属单元设置为相同的频道(CH)编号即可。按菜单按键 $\langle \text{MENU} \rangle$ 进入菜单C.Fn, 旋转调节旋钮选择CH, 按SET按键, 再旋转调节旋钮进行频道选择(01- 32), 选好后短按SET按键退出频道设置。

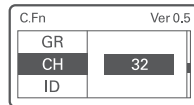

## • 组别(GR)设置

进入菜单C.Fn, 旋转调节旋钮选择GR, 按SET按键, 再旋转调节旋钮进行组别选择(A/B/C/D/E), 选好后短按SET按键退出组别设置。

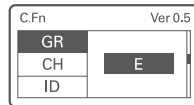

## • ID设置

进入菜单C.Fn, 旋转调节旋钮选择ID, 按SET按键, 再旋转调节旋钮进行ID选择(OFF/01~99), 选好后短按SET按键退出ID设置。

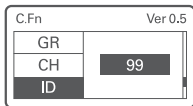

注: 主控单元具备此功能时才能使用。

## ⚠ 神牛2.4G无线漏闪的原因及解决办法:

### 1. 外部环境2.4G信号干扰(如无线基站、2.4G wifi路由、蓝牙设备等)

- 请调节引闪器的频道CH设置(建议+10), 找到无干扰的频道来工作, 或者在工作时关闭其他2.4G设备。

### 2. 请确认闪光灯是否已经回电或者回电速度是否已经跟上连拍速度(闪光灯就绪指示灯已经亮起), 并且没有处于过热保护或者其他异常状态中

- 请下调闪光灯功率的档位, 如是TTL模式请尝试改为M模式(TTL模式下需要预闪一次)。

### 3. 是否引闪器和闪光灯距离太近(距离<0.5m)

- 请在引闪器上打开“近距离无线模式”:  
X1系列: 按住引闪按钮不放, 然后开机, 直至指示灯闪2次。  
X2、Xpro系列: 设置C.Fn-DIST为0-30m。

### 4. 是否引闪器和接收端设备在低电状态

- 请更换电池(引闪器电池建议使用1.5V一次性碱性电池)。

## C.Fn: 设置自定义功能

1. 按菜单按键<☰>进入菜单C.Fn, 旋转调节旋钮选择自定义功能符号。
2. 按SET按键选中, 旋转调节旋钮进行设置。
3. 设置好后按SET按键确认, 再按菜单按键<☰>退出。

自定义功能符号	功能	设置	设置说明
MODE	闪光模式	M	手动闪光
		TTL	自动闪光
PHOTOC	S1/S2光控引闪	OFF	关闭光控引闪
		S1	S1光控同步引闪
		S2	S2光控防预闪引闪
WL	无线设置	ON	无线打开
		OFF	无线关闭
GR	组别设置	A/B/C/D/E	可以选择A/B/C/D/E任意一个字母
CH	频道设置	1~32	可以选择1~32任意一个数字
ID	ID设置	OFF/01~99	可以选择OFF或01~99任意一个数字
STBY	自动关机	OFF	关闭
		30min	超过30min/60min/90min没有使用
		60min	闪光灯, 该灯会自动进入关机程序
		90min	

## 强制关机功能

当灯体出现死机、无法操作等现象时, 用针插入复位孔, 触发按键, 实现强制关机功能。

## 热保护功能

开启最大档闪光, 闪光次数达到50次时, 显示屏出现热保护符号, 提醒用户闪光灯机体过热。建议让微距闪光灯暂时停止工作。

## 复位功能

同时长按☰菜单按键与⊗造型灯按键, 实现灯体参数复位功能。



## 规格参数

型号	MF12
内置锂电池	3.7V/1700mAh
闪光指数(1/1档位)	GN=16.1(±0.1)
闪光灯功率	12W
闪光灯档位	8级: 1/128~1/1
LED造型灯亮度	1~10级
显示屏	OLED液晶屏
光控引闪	S1光控同步引闪/S2光控防预闪引闪
闪光模式	TTL模式、M手动闪光模式
持续闪光时间	1/1200s~1/34000s
2.4G无线传输	ON/OFF
频道	32个频道:1~32
组别	5组组别:A/B/C/D/E
ID	OFF/01~99
传输距离	30m
TYPE-C充电电源	5V2A
全功率闪光次数	约500次
回电时间	约0.01~1.7秒
电池电量指示	显示屏右上角提示剩余电量
节能	30min/60min/90min:超过30min/60min/90min没有使用闪光灯,该灯自动进入关机程序OFF:关闭自动关机模式,节能性能无效
尺寸	
体积	81*76.5*64.3mm
净重	≈144g

## 维修保养

- 闪光灯在工作时,如发现异常,应立即关掉电源,查明原因。
- 灯体应避免震动,平时注意表面除尘。
- 灯体稍有发热为正常现象,无特别需要时,勿连续引闪。
- 闪光灯的所有维修概由本厂指定可供原厂配件之维修部负责。
- 1年保修,消耗品如灯管等,不在1年保修范围。
- 经发现,擅自检修此闪光灯的,将取消闪光灯之一年保修期,维修需要收取相关费用。
- 如果本品出现故障或者被水淋湿,在专业人员维修后方可继续使用。
- 如有技术更改,恕不另行通知。

# Contents

18	<b>Forward</b>
19	<b>Warning</b>
21	<b>Names of Parts</b>
	Body
	Control Panel
	OLED Display
22	<b>Included Items</b>
22	<b>Optional Accessories</b>
25	<b>Battery</b>
25	<b>Battery Management</b>
26	<b>Modeling Lamp</b>
26	<b>Flash Mode Selection</b>
	TTL Auto Flash Mode
	M Manual Flash Mode
28	<b>Wireless(2.4G) Transmission</b>
30	<b>C.Fn: Setting Custom Functions</b>
30	<b>Reset Function</b>
30	<b>Forced Shutdown Function</b>
30	<b>Over-Temperature Function</b>
31	<b>Technical Data</b>
32	<b>Maintenance</b>

## Foreword

Thank you for purchasing!

MF12 is a mini macro flash.

Functionally, MF12 is equipped with two flash modes: TTL automatic flash mode and M manual flash mode. With S1 / S2 secondary optic triggering mode, no additional command signal or external remote control, direct trigger flash, convenient. Allocated with always-on LED modeling light, it provides modeling light anywhere anytime, which can also be used as a background light, hair light, or daily lighting.

In terms of structure, MF12 adopts professional optical lens design, which has stronger focusing effect and ensures even distribution of shooting light effect. Built-in rechargeable lithium battery, it is convenient for outdoor shooting and travel shooting. Menu easy to operate, compact and light-weight size ensure it can be put into pocket with great portability.

This mini flash is ideal for macro photography of animals and plants, food, jewelry, oral images and so on.

### Main Features

- Equipped with TTL automatic flash mode and M manual flash mode
- Having S1 / S2 secondary optic triggering modes
- Using a constant light LED modeling Light
- Adopted professional optical lens which offers more even lights
- Built-in 2.4G wireless X system
- Selecting the clear OLED display
- With built-in lithium battery which can be charged through Type-C port
- Max.1.7s recycle and 500 full power pops

## ⚠ Warning

- ⚠ Always keep this product dry.
- ⚠ Do not disassemble. Should repairs become necessary, this product must be sent to an authorized maintenance center.
- ⚠ Keep out of reach of children.
- ⚠ Stop using this product if it breaks open due to extrusion, falling or strong hit. Otherwise, electric shock may occur if you touch the electronic parts inside it.
- ⚠ Do not fire the flash directly into the eyes (especially those of babies) within short distances. Otherwise visual impairment may occur.
- ⚠ Do not use the flash unit in the presence of flammable gases, chemicals and other similar materials. In certain circumstance, these materials may be sensitive to the strong light emitting from this flash unit and fire or electromagnetic interference may result.
- ⚠ Do not leave or store the flash unit if the ambient temperature reads over 50. Otherwise the electronic parts may be damaged.
- ⚠ As this product do not have waterproof function, please take measures of waterproof in rainy or damp environment.
- ⚠ Turn off the flash unit immediately in the event of malfunction.

## Names of Parts

### • Body

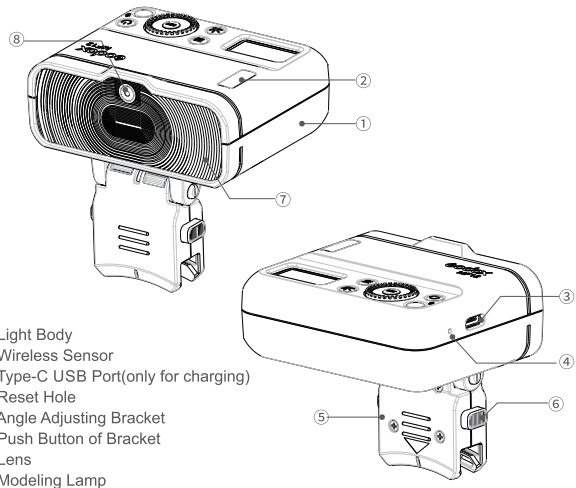

## Names of Parts

### • Control Panel

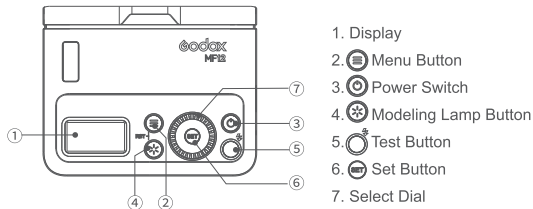

### • OLED Display



TTL Autoflash

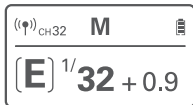

M Manual Flash

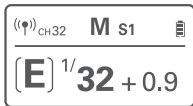

S1/S2

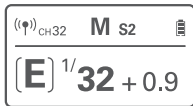

## Included Item

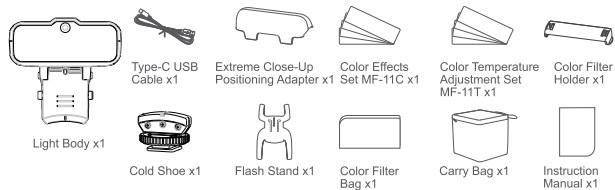

**Note:** MF12 Two-light Kit is not only including above items but also including 1 unit MF-AR Adapter Ring and 8 pieces lens adaptor rings (Diameters of 49mm,52mm,55mm,58mm, 62mm,67mm,72mm, 77mm).

## Optional Accessories

The product can be used in combination with the following optional accessories, so as to achieve best photography effects: XPro, X1 and X2 TTL flash trigger, MF-AR adapter ring, camera lens adapter rings kit (49mm, 52mm, 55mm, 58mm, 62mm, 67mm, 72mm, 77mm), etc.



## Install Accessories

### • How to Install Cold Shoe

1. Press and hold down the push button of MF12's fixing bracket. Then, aim one end of the cold shoe into the end of bracket and slide it to install until a "click" can be heard.
2. Attach the cold shoe onto the hotshoe of camera firstly. Then, turn the locking ring and lock them.

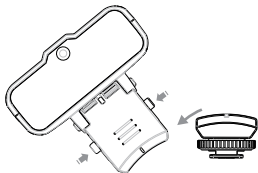

### • How to Use Adapter Ring (Optional)

1. Aim the socket of MF12 into the sliding block and push it until a "click" can be heard. One adapter ring can install 6 lights at most.

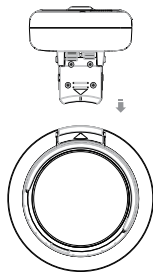

2. MF12 can be rotated leftwards or rightward by pressing the push button of bracket.

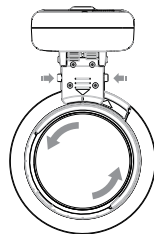

3. Choose the optional adapter ring (8 different diameters of 49mm, 52mm, 55mm, 58mm, 62mm, 67mm, 72mm, 77mm, etc.) whose size is suitable for the neck strap of camera lens. Install the camera's adapter ring onto the MF-AR adapter ring.

4. Attach the adapter ring onto the camera lens.

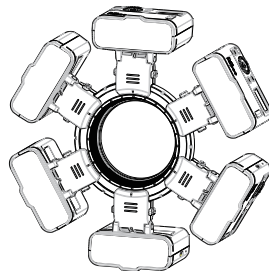

## Battery

1. This adopts Li-ion battery which is non-detachable.
2. It is reliably safe. The inner circuit is against overcharge, overdischarge, overcurrent, and short circuit.
3. Take only approx. 55 minutes (within 1 hour) to fully charge the battery by using the 5V/2A charger.

### • Battery Level Indicator

Battery Level Indication	Meaning
3 grids	Full
2 grids	Middle
1 grid	Low
Blank grid	Low battery, please recharge it.
 is displayed	The battery level is going to be used out immediately. And the flash will auto power off in 10 seconds. Note: please recharge the battery as soon as possible (within 10 days). Then, the battery can be used or be placed for long period.

## Power Management

Please turn off the power if not used for a long time.

### Auto Power off Mode Setting

Press the menu button, turn the Dial to select STBY, press the SET button, and then turn the Dial to select 30min/60min/90min/OFF. After setting the auto power off mode, the flash will automatically shut down when unattended operation for a long time (more than 30/60/90 minutes). When it is automatically shut down, please press the power on button to restart it, the boot animation appears, turn the Dial to operate.



When using off the camera, it is recommended to turn off the "auto power off" mode through C.Fn-STBY of custom setting functions.

## Modeling Lamp

### 1. Modeling lamp power ON/OFF:

1.1. Short press the  button to control the on/off of LED modeling lamp.

1.2. Long press the  button to enter the modeling lamp interface and then short press SET button to on/off modeling lamp.

2. **Modeling lamp setting:** long press the  button to enter modeling lamp interface.

2.1 Brightness setting: turn the select dial to setting the brightness value from 1 to 10 levels.



## Flash Mode Selection

MF12 flash has two modes: TTL autoflash and M manual flash. In TTL mode, the camera and the flash will work together to calculate the correct exposure for the subject and the background.

The main subject is correctly exposed regardless of background brightness. This is useful when you want to highlight the main subject or make exposure compensation. In Manual flash photography, you select the aperture and flash output level. In this way, you can control the exposure and flash shooting distance when shooting subjects where the correct exposure is difficult to obtain in the TTL auto flash mode.

Short press the  menu button and turn the select dial to choose MODE. Then, short press the SET button and turn the select dial to choose TTL or M mode. Then, short press the SET button to exit from Mode Selection.

### • TTL Autoflash Mode

Choose TTL mode and press the  menu button to back to the interface and the flash will enter TTL autoflash mode.

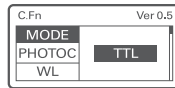

## • M Manual Flash Mode

The flash output is adjustable from 1/128 to 1/1 full power in 0.1 and 1 step increment.

1. Choose M and press the  menu button to back to the main interface.
2. In M mode's main interface, turn the select dial to set the flash output value.

To obtain a correct flash exposure, use a hand-held flash meter to determine the required flash output.

## • Light Control Flash (PHOTOC)

In M manual mode, press the  menu button to enter C.Fn and turn the select dial to choose PHOTOC. Then, press the SET button and turn the select dial to choose S1 or S2 function.

### • S1 Secondary Optic Triggering

Choose S1 light control synchronous flash, flash MF12 can be used as auxiliary Light, create a variety of lighting effects, suitable for manual flash environment. It will trigger the flash synchronously with the first flash of the main flash. The effect is the same as using the wireless flash guide, and the response is sensitive.

### • S2 Secondary Optic Triggering with Anti-preflash

Select S2 light control to prevent pre flash, flash MF12 can be used as auxiliary light, suitable for TTL automatic flash shooting environment. With high-energy anti pre flash function, when using the camera with a pre flash function, S2 light control pre flash function is used to achieve synchronous shooting. At the same time, it will trigger the flash synchronously with the second flash of the main flash with TTL function, that is, the second light control flash.

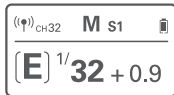
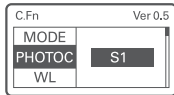
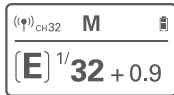

 MF12 flash only supports S1/S2 light control flash in M manual flash mode.

## Wireless Radio Transmission

With built-in Godox 2.4G wireless X system, this MF12 can be used in combination with Godox X1, XPro and X2 trigger. As an auxiliary unit, MF12 can be compatible with Canon, Nikon, Sony, Panasonic, Olympus/Fuji system and switched automatically. Nikon camera (using X1T-N), Canon camera (using X1T-C) and Sony camera (using X1T-S) can share one or more MF12's TTL functions.

## • Wireless (WL) Setting

Press the  menu button to enter C.Fn custom setting. Turn the select dial to choose wireless WL, press the SET button, and turn the select dial to choose ON or OFF. OFF means the wireless function is turned off while ON means turned on.

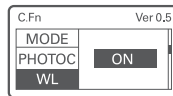

## • Channel (CH) Setting

If there are other wireless flash systems nearby, you can change the channels to prevent signal interference. The channel (CH) of the transmitter unit and the receiver unit(s) must be set to the same. Press the  menu button to enter C.Fn menu. Turn the select dial to choose CH. Press the SET button and turn the select dial to choose channel from 01- 32. Then, short press the SET button to exit from CH setting.

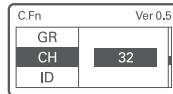

## • Group (GR) Setting

Enter C.Fn menu and turn the select dial to choose GR. Press the SET button and turn the select dial to choose group from A/B/C/D/E. Then, short press the SET button to exit from GR setting.

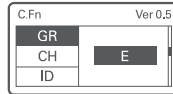

## • ID Setting

Enter C.Fn menu and turn the select dial to choose ID. Press the SET button and turn the select dial to choose ID from OFF and 01 to 99. Then, short press the SET button to exit from ID setting.

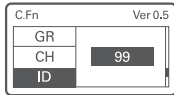

Note: this can only be used when the main unit has this function.

## ⚠ The Reason & Solution of Not Triggering in Godox 2.4G Wireless

### 1. Disturbed by the 2.4G signal in outer environment (e.g. wireless base station, 2.4G wifi router, Bluetooth, etc.)

→ To adjust the channel CH setting on the flash trigger (add 10+ channels) and use the channel which is not disturbed. Or turn off the other 2.4G equipment in working.

### 2. Please make sure that whether the flash has finished its recycle or caught up with the continuous shooting speed or not(the flash ready indicator is lighten) and the flash is not under the state of over-heat protection or other abnormal situation.

→ Please downgrade the flash power output. If the flash is in TTL mode, please try to change it to M mode(a preflash is needed in TTL mode).

### 3. Whether the distance between the flash trigger and the flash is too close or not

→ Please turn on the "close distance wireless mode" on the flash trigger (<0.5m):

→ X1 series: Press and hold the flash button, then turn on the machine until the indicator light flashes twice.

X2, Xpro series: Set C.Fn-DIST to 0-30m.

### 4. Whether the flash trigger and the receiver end equipment are in the low battery states or not

→ Please replace the battery(the flash trigger is recommended to use 1.5V disposable alkaline battery).

## C.Fn: Setting Custom Functions

1. Press the <⊞> button to enter C.Fn and turn the select dial to choose the custom setting functions.
2. Press the SET button and turn the select dial to set the parameters.
3. After finishing all the settings, press the SET button to confirm and press the <⊞> button to exit.

Custom Function	Functions	Settings	Settings & Descriptions	
Signs	MODE	Flash mode	M	Manual flash
		TTL	Auto flash	
PHOTOC	S1/S2 Light controlled flash	OFF	Off	
		S1	S1 Secondary Optic Triggering	
		S2	S2 Secondary Optic Triggering with Anti-preflash	
WL	Wireless setting	ON	Wireless on	
		OFF	Wireless off	
GR	Group setting	A/B/C/D/E	Choose any letters from A/B/C/D/E	
CH	Channel setting	1~32	Choose any figure from 1 to 32	
ID	ID setting	OFF/01~99	Choose any figure from 01 to 99 or OFF	
STBY	Auto power off	OFF	Off	
		30min	The flash will automatically shut down when unattended operation for a long time (more than 30/60/90 minutes).	
		60min		
		90min		

## Forced Shutdown Function

When the light's system crashes or cannot be operated, insert a needle into the reset hole to forced shutdown the device.

## Over-Temperature Protection

When the continuous flashes fires up to 50 times in fast succession at 1/1 full power, an Over-Temperature Protection symbol appears on the display to remind the user that the flash unit is overheated. It is recommended to temporarily stop the macro flash.

## Reset Function

Long press ⊞ menu button and ⊛ modeling lamp button at the same time to realize the function of settings reset function.



## Technical Data

<b>Model</b>	MF12
Built-in Lithium Battery	3.7V/1700mAh
Guide No. (1/1 output)	GN=16.1 (±0.1)
Flash Power	12W
Output Level	8 levels: 1/128~1/1
Brightness of LED Modeling Lamp	1~10 Levels
Display	OLED Display
Optical Flash	S1 Secondary Optic Triggering S2 Secondary Optic Triggering with Anti-preflash
Flash Mode	TTL Autoflash, M manual flash
Flash Duration	1/1200s~1/34000s
2.4G Wireless Transmission	ON/OFF
Channel	32 channel: 1~32
Group	5 group: A/B/C/D/E
ID	OFF/01~99
Transmission Distance	30m
Type-C Power Charging	5V 2A
Full Power Flashes	Approx. 500
Recycle Time	Approx. 0.01~1.7s
Battery Level Indication	Battery level indicator shows on the upper right corner of the display
Power Saving	30min/60min/90min: It will automatically power off when unattended operation over 30min/60min/90minutes. OFF: Turn off auto power off mode, energy-saving performance is invalid.
2.4G Wireless Frequency Range	2413.0MHz-2464.5MHz
<b>Dimension</b>	
Size	81*76.5*64.3mm
Net Weight	≈144g

## Maintenance

- Shut down the device immediately should abnormal operation be detected.
- Avoid sudden impacts and the product should be dedusted regularly.
- It is normal for the light beads to be warm when in use. Avoid continuous flashes if unnecessary.
- Maintenance of the light must be performed by our authorized maintenance department which can provide original accessories.
- This product, except consumables, is supported with a one-year warranty. Lithium battery is supported with six months warranty.
- Unauthorized service will void the warranty.
- If the product had failures or was wetted, do not use it until it is repaired by professionals.
- Changes made to the specifications or designs may not be reflected in this manual.

## FCC Statement

This device complies with part 15 of the FCC Rules. Operation is subject to the following two conditions: (1) This device may not cause harmful interference, and (2) this device must accept any interference received, including interference that may cause undesired operation.

Note: This equipment has been tested and found to comply with the limits for a Class B digital device, pursuant to part 15 of the FCC Rules. These limits are designed to provide reasonable protection against harmful interference in a residential installation. This equipment generates uses and can radiate radio frequency energy and, if not installed and used in accordance with the instructions, may cause harmful interference to radio communications. However, there is no guarantee that interference will not occur in a particular installation. If this equipment does cause harmful interference to radio or television reception, which can be determined by turning the equipment off and on, the user is encouraged to try to correct the interference by one or more of the following measures:

- Reorient or relocate the receiving antenna.
- Increase the separation between the equipment and receiver.
- Connect the equipment into an outlet on a circuit different from that to which the receiver is connected.
- Consult the dealer or an experienced radio/TV technician for help.

The light source contained in this luminaire shall only be replaced by the manufacturer or his service agent or a similar qualified person.

The lamp shall be changed if it has become damaged or thermally deformed.

The luminaire is intended for professional use only.

# 产品保修

尊敬的用户，本保修卡是申请保修服务的重要凭证，请您配合销售商填写并妥善保管，谢谢！

产品信息	型号	产品条码
用户信息	姓名	联系电话
	通信地址	
销售商信息	名称	
	联系电话	
	通信地址	
	销售日期	
备注		

注：此表应由销售商盖章确认。

## 适用产品

本文件适用于相关《产品保修信息》(见后面说明)所列产品，其他非属此范围的产品或部件(如促销品、赠品及其他出厂后附加的部件等)不在此保修承诺内。

## 保修期

产品及部件的相应保修期按相关的《产品保修信息》执行。保修期自产品首次购买日起算，购买日以购买产品时保修卡登记日期为准。

## 如何获得保修服务

您可直接与产品销售商或授权服务机构联系，也可拨打神牛产品售后服务电话，与我们联系，由我们的服务人员为您安排服务。申请保修时，您应提供有效的保修卡作为保修凭证，方可获得保修。如您不能提供有效的保修卡，则在我们确认产品或部件属于保修范围的情况下，也可以为您提供保修，但这不作为我们的义务。

## 不适用保修的情况

如产品存在下列情况，本文件项下的保证和服务将不适用 ①产品或部件超过相应保修期；②错误或不当使用、维护或保管导致的故障或损坏，如：不当搬运；非按产品合理预期用途使用；不当插拔外接设备；跌落或外力挤压；接触或暴露于不适当温度、溶剂、酸碱、水浸或潮湿环境；③由非神牛授权机构或人员安装、修理、更改、添加或拆卸造成的故障或损坏；④产品或部件原有识别信息被修改变更或删除；⑤无有效保修卡；⑥使用非合法授权、非标准或非公开发行的软件造成的故障或损坏；⑦因不可抗力或意外事件造成的故障或损坏；⑧其他非因产品本身质量问题导致的故障或损坏。遇上述情况，您应向相关责任方寻求解决，神牛对此不承担任何责任。因非在保修期或保修范围内的部件、附件或软件导致产品不能正常使用的，不是保修范围内的故障。产品使用过程中正常的脱色，磨损和消耗，不是保修范围内的故障。

产品保修和服务支持信息: 产品的保修期和服务类型按以下《产品保修信息》执行:

产品类别	选项名称	保修期(月)	保修服务类型
部件	电路板	12	客户送修
	电池	3	客户送修
	充电器、电源线，同步线等带电性能的部件。	12	客户送修
其他	如闪光管、造型灯泡、外壳、保护罩、锁紧装置、包装等。	无	无保修

神牛产品售后服务电话 0755-29609320-8062

## Warranty

Dear customers, as this warranty card is an important certificate to apply for our maintenance service, please fill in the following form in coordination with the seller and safe-keep it. Thank you!

Product Information	Model	Product Code Number
Customer Information	Name	Contact Number
	Address	
Seller Information	Name	
	Contact Number	
	Address	
	Date of Sale	
Note:		

Note: This form shall be sealed by the seller.

### Applicable Products

The document applies to the products listed on the **Product Maintenance Information** (see below for further information). Other products or accessories (e.g. promotional items, giveaways and additional accessories attached, etc.) are not included in this warranty scope.

### Warranty Period

The warranty period of products and accessories is implemented according to the relevant Product Maintenance Information. The warranty period is calculated from the day(purchase date) when the product is bought for the first time, And the purchase date is considered as the date registered on the warranty card when buying the product.

### How to Get the Maintenance Service

If maintenance service is needed, you can directly contact the product distributor or authorized service institutions. You can also contact the Godox after-sale service call and we will offer you service. When applying for maintenance service, you should provide valid warranty card. If you cannot provide valid warranty card, we may offer you maintenance service once confirmed that the product or accessory is involved in the maintenance scope, but that shall not be considered as our obligation.

### Inapplicable Cases

The guarantee and service offered by this document are not applicable in the following cases: ①. The product or accessory has expired its warranty period; ②. Breakage or damage caused by inappropriate usage, maintenance or preservation, such as improper packing, improper usage, improper plugging in/out external equipment, falling off or squeezing by external force, contacting or exposing to the improper temperature, solvent, acid, base, flooding and damp environments, etc; ③. Breakage or damage caused by non-authorized institution or staff in the process of installation, maintenance, alternation, addition and detachment; ④. The original identifying information of product or accessory is modified, alternated, or removed; ⑤. No valid warranty card; ⑥. Breakage or damage caused by using illegally authorized, nonstandard or non-public released software; ⑦. Breakage or damage caused by force majeure or accident; ⑧. Breakage or damage that could not be attributed to the product itself. Once met these situations above, you should seek solutions from the related responsible parties and Godox assumes no responsibility. The damage caused by parts, accessories and software that beyond the warranty period or scope is not included in our maintenance scope. The normal discoloration, abrasion and consumption are not the breakage within the maintenance scope.

### Maintenance and Service Support Information

The warranty period and service types of products are implemented according to the following **Product Maintenance Information**:

Product Type	Name	Maintenance Period(month)	Warranty Service Type
Parts	Circuit Board	12	Customer sends the product to designated site
	Battery	3	
	Electrical parts e.g.battery charger, power cord, sync cable, etc.	12	
Other Items	Flash tube, modeling lamp, lamp body, lamp cover, lockingdevice, package, etc.	No	Without warranty

Godox After-sale Service Call +86-755-29609320-8062

Warning

Operating frequency:2412.99MHz – 2464.49MHz (only receive)

Declaration of Conformity

GODOX Photo Equipment Co.,Ltd. hereby declares that this equipment are in compliance with the essential requirements and other relevant provisions of Directive 2014/53/EU. In accordance with Article 10(2) and Article 10(10), this product is allowed to be used in all EU member states.For more information of DoC, Please click this web link:

[https://www.godox.com/DOC/Godox\\_MF12\\_DOC.pdf](https://www.godox.com/DOC/Godox_MF12_DOC.pdf)

The device complies with RF specifications when the device used at 0mm from your body.