

OPzS2-600(2V600Ah)



OPzS series is flooded Lead Acid battery that adopts Tubular Plate technology to offer high reliability and performance. The Battery is designed and manufactured according to standards and with DIN40736/IEC60896 positive spine and patent formula of die-casting active material. The OPzS series batteries offer 400% more cyclic life than the standby series. It is suitable for solar and wind renewable energy storage, traction etc. The OPzS series is the best choice of energy storage system in high altitude area.



Specification

Cells Per Unit	1
Voltage Per Unit	2V
Nominal Capacity	600Ah@10hour-rate to 1.80V per cell @25°C
Weight	Without Electrolyte 36.5 kg(Tolerance ±5%) With Electrolyte 46.4kg (Tolerance ±5%)
Internal Resistance	≤0.45 mΩ (Full Charge Condition @25°C)
Terminal	Default F10(M8)
Max. Discharge Current	2500A (5 sec)
Design Life	20 years
Max. Charging Current	90.0 A
Reference Capacity	C ₃ 458.4Ah C ₅ 519.5Ah C ₁₀ 600.0Ah C ₂₀ 726.0Ah
Float Charging Voltage	2.23 V~2.25 V @ 25°C Temperature Compensation: -3mV/°C/Cell
Cycle Use Voltage	2.40 V~2.45 V @ 25°C Temperature Compensation: -4mV/°C/Cell
Operating Temperature Range	Discharge: -15°C~50°C Charge: 0°C~40°C Storage: -15°C~50°C
Normal Operating Temperature Range	25°C ±5°C
Self Discharge	OPzS series is flooded Lead Acid battery. It can be stored for up to 2 years before filling acid. Monthly Self-discharge ratio is less than 3.5% at 20°C. Please charged batteries before using.
Container Material	S.A.N. UL94-HB, UL94-V0 Optional.

Dimensions

Unit: mm

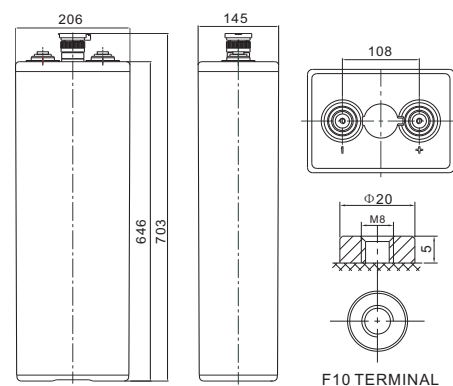

Length	145±2mm (5.71 inches)
Width	206±2mm (8.11 inches)
Height	646±2mm (25.4 inches)
Total Height	703±2mm (27.7 inches)
Torque Value	10~12 N*m

Constant Current Discharge Characteristics :A(25°C)

F.V/ Time	30min	1h	2h	3h	4h	5h	6h	8h	10h	20h
1.60V	633.1	408.4	241.8	176.1	135.8	113.8	99.2	78.0	65.7	37.8
1.65V	613.9	384.3	234.0	171.8	133.9	112.3	97.9	77.4	65.1	37.4
1.70V	566.9	372.3	227.4	167.8	131.6	110.6	96.7	76.8	64.4	37.0
1.75V	508.7	347.6	217.6	162.6	129.4	108.6	94.8	75.5	63.2	36.3
1.80V	459.4	310.0	201.5	152.8	123.7	103.9	90.7	72.1	60.0	34.5
1.85V	383.1	265.7	180.2	138.7	114.2	96.0	84.0	67.3	56.2	32.3

Constant Power Discharge Characteristics : W/Cell(25°C)

F.V/ Time	30min	1h	2h	3h	4h	5h	6h	8h	10h	20h
1.60V	1071	696.6	442.0	330.0	262.4	220.4	192.7	153.0	130.5	75.0
1.65V	1053	667.0	430.1	323.3	259.1	218.0	190.8	151.7	129.9	74.7
1.70V	999.9	660.3	419.6	316.7	255.0	215.1	188.9	150.4	128.7	74.0
1.75V	921.8	632.1	406.4	309.5	251.7	212.0	185.8	148.5	126.8	72.9
1.80V	855.4	579.0	381.4	293.4	241.3	203.4	178.5	142.9	121.6	69.9
1.85V	733.3	510.1	348.4	269.8	223.5	188.8	166.2	134.7	114.6	65.9

(Note) The above characteristics data are average values obtained within three charge/discharge cycle not the minimum values.

The battery must be fully charged before the capacity test. The C₁₀ should reach 95% after the first cycle and 100% after the third cycle.

OPzS2-600(2V600Ah)



Discharge Characteristics Curve

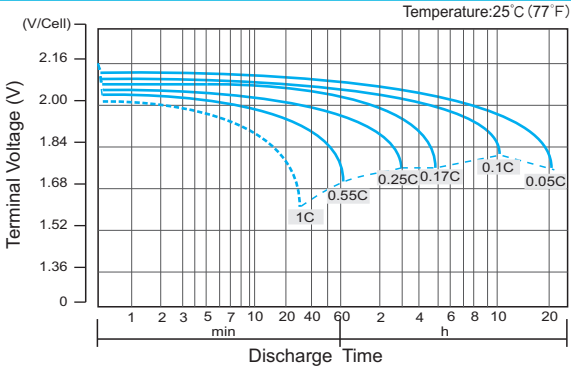

Charge Characteristic Curve for Cycle Use(IUU)

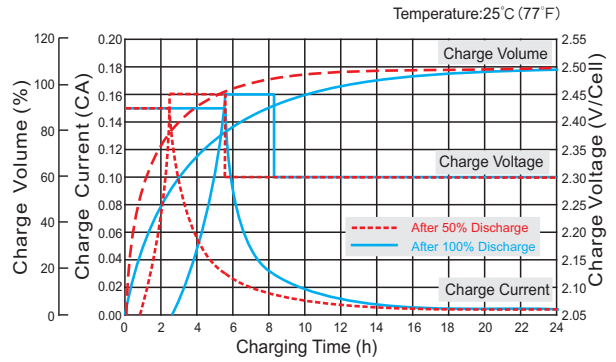

Cycle Life in Relation to Depth of Discharge

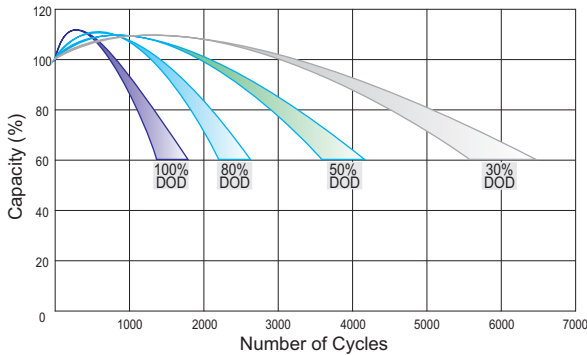

Relationship Between Charging Voltage and Temperature

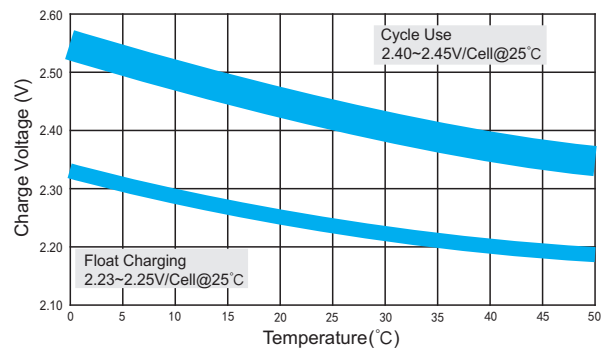

Temperature Effects on Capacity

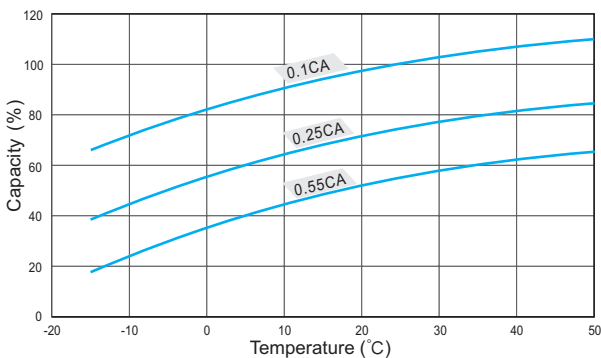

Storage Characteristics

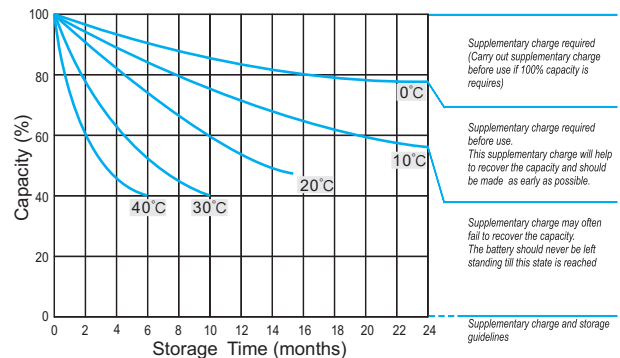

Effect of Temperature on Long Term Life

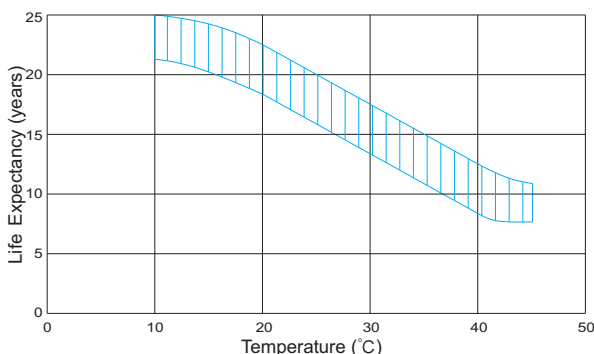

Life Characteristics Of Standby Use

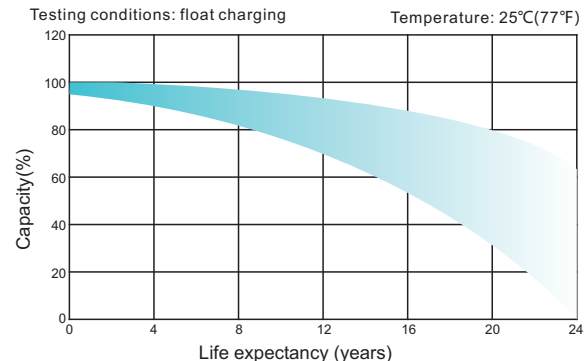

(Note) All above information shall be changed without prior notice, RITAR reserves the right to explain and update the latest information.