

OPzV2-300(2V300Ah)

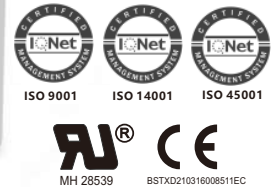

OPzV series is Valve Regulated Lead Acid battery that adopts immobilized GEL and Tubular Plate technology to offer high reliability and performance. The Battery is designed and manufactured according to DIN standards and with die-casting positive grid and patented formula of active material OPzV series exceeds DIN standard values with more than 25 years floating design life at 25°C and It is the best solution for cyclic use under extreme operating conditions.



Specification

Cells Per Unit	1
Voltage Per Unit	2V
Nominal Capacity	300Ah@10hour-rate to 1.80V per cell @25°C
Weight	Approx. 23.5Kg (Tolerance 5%)
Internal Resistance	≤0.85 mΩ (Full Charge Condition @25°C)
Terminal	Default F10(M8)
Max. Discharge Current	1350A (5 sec)
Design Life	25 years
Max. Charging Current	60.0 A
Reference Capacity	C ₃ 225.0Ah C ₅ 255.0Ah C ₁₀ 300.0Ah C ₂₀ 322.0Ah
Float Charging Voltage	2.23 V~2.25 V @ 25°C Temperature Compensation: -3mV/°C/Cell
Equalization Charging Voltage	2.30 V~2.35 V @ 25°C Temperature Compensation: -4mV/°C/Cell
Operating Temperature Range	Discharge: -40°C~60°C Charge: 0°C~50°C Storage: -40°C~60°C
Normal Operating Temperature Range	25°C 5 °C
Self Discharge	RITAR Valve Regulated Lead Acid (VRLA) batteries can be stored for up to 6 months at 25°C and then recharging is recommended. Monthly Self-discharge ratio is less than 2% at 20°C. Please charged batteries before using.
Container Material	A.B.S. UL94-HB, UL94-V0 Optional.

Dimensions

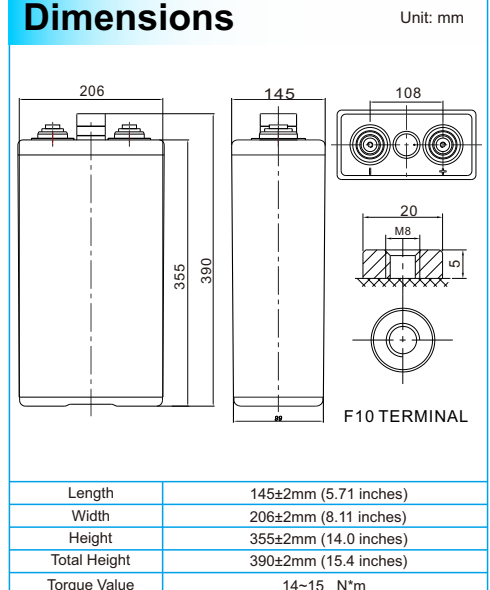

Constant Current Discharge Characteristics : A(25°C)

F.V/ Time	1HR	2HR	3HR	4HR	5HR	8HR	10HR	20HR	24HR	48HR	72HR	100HR
1.60V	163.0	106.1	80.7	64.2	54.3	37.5	31.5	16.5	14.2	7.48	5.25	3.94
1.65V	160.4	104.7	79.8	63.5	53.7	37.2	31.2	16.4	14.0	7.41	5.16	3.90
1.70V	156.4	102.9	78.3	62.4	52.8	36.6	30.9	16.2	13.9	7.34	5.11	3.86
1.75V	149.8	100.3	76.8	61.4	52.2	36.3	30.6	16.1	13.8	7.27	5.06	3.83
1.80V	144.0	97.0	75.0	60.0	51.0	35.7	30.0	15.8	13.5	7.13	4.96	3.75
1.85V	128.7	88.5	69.0	55.5	47.4	33.3	28.2	14.8	12.7	6.70	4.66	3.53

Constant Power Discharge Characteristics : W/Cell(25°C)

F.V/ Time	1HR	2HR	3HR	4HR	5HR	8HR	10HR	20HR	24HR	48HR	72HR	100HR
1.60V	283.8	195.2	153.8	123.3	104.8	73.1	61.6	32.6	27.7	14.6	10.3	7.70
1.65V	281.9	193.4	152.7	122.4	104.0	72.7	61.2	32.4	27.5	14.5	10.1	7.65
1.70V	277.3	191.2	150.4	120.7	102.6	71.7	60.7	32.1	27.3	14.4	10.0	7.59
1.75V	268.0	187.2	148.1	119.3	101.8	71.4	60.3	31.8	27.1	14.3	10.0	7.54
1.80V	260.0	182.1	145.2	116.9	99.8	70.4	59.3	31.2	26.7	14.1	9.80	7.41
1.85V	234.5	166.9	134.1	108.6	93.1	65.8	55.8	29.4	25.1	13.3	9.23	6.98

(Note) The above characteristics data are average values obtained within three charge/discharge cycle not the minimum values. The battery must be fully charged before the capacity test. The C₁₀ should reach 95% after the first cycle and 100% after the third cycle.

OPzV2-300(2V300Ah)



Discharge Characteristics Curve

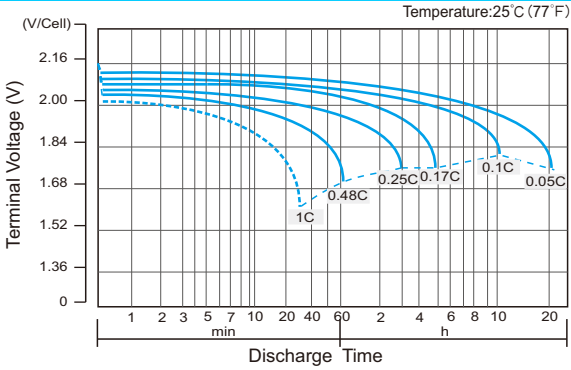

Charge Characteristic Curve for Cycle Use(IUU)

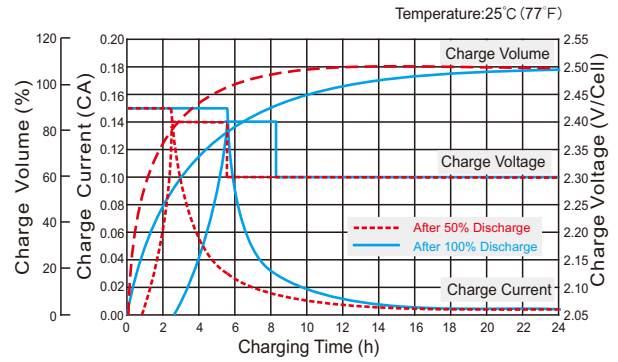

Cycle Life in Relation to Depth of Discharge

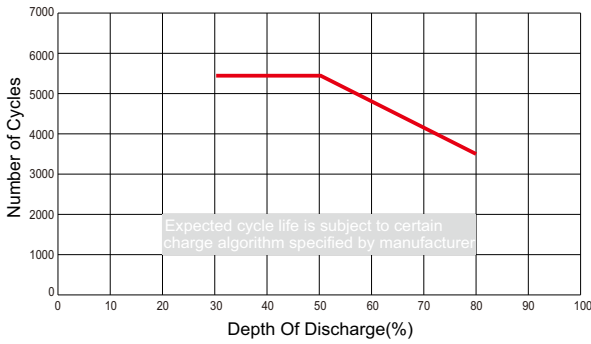

Relationship Between Charging Voltage and Temperature

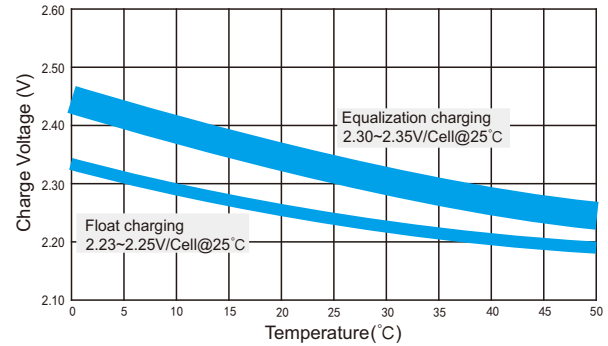

Temperature Effects on Capacity

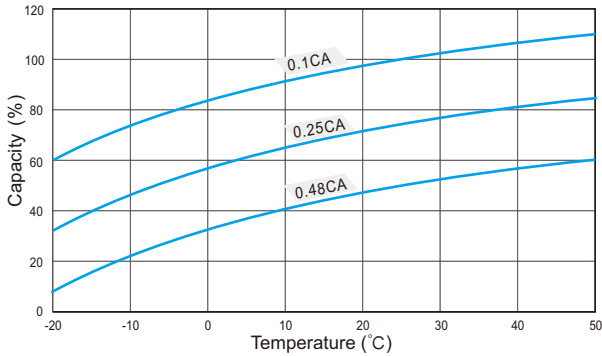

Storage Characteristics

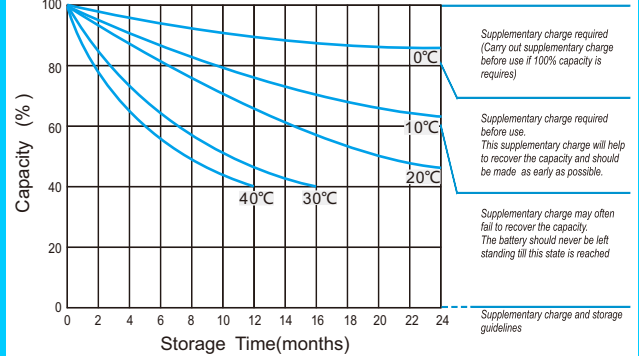

Effect of Temperature on Long Term Life

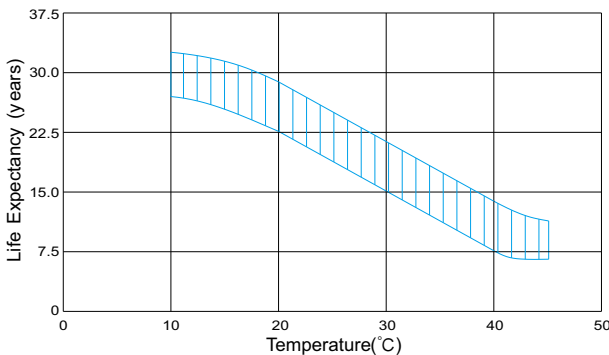

Relationship of OCV And State of Charge(20°C)

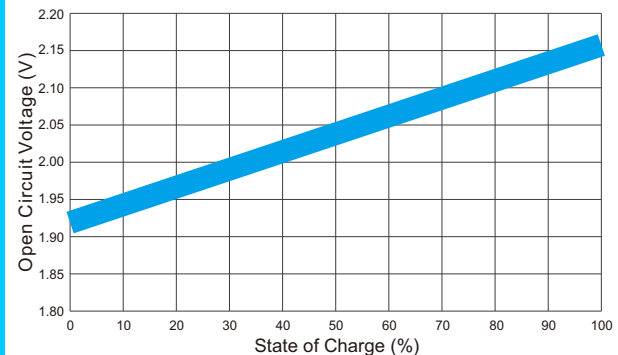

(Note) All above information shall be changed without prior notice, RITAR reserves the right to explain and update the latest information.