

Precaution

To avoid fire or electrical shock, do not expose this product to rain or moisture.

To avoid short circuit, please make sure the batteries contacts are securely packed and use the battery in accordance with the local provisions.

Please place the batteries and the parts which can be swallowed mistakenly away from children. If swallowed, please get medical help immediately.

To avoid any possible injury to eyes, do not use the flash in a short distance from the eyes.

To avoid any possible safety accident, do not use the flash on the people focusing attention.

Please take out the batteries and stop using this product immediately in case of the following situation:

- This product is dropped or shocked seriously and the inner part of this product is bared.

- Wear gloves and take the batteries out if the corrosive liquid inside the batteries leaks.

- This product gives off strange smell, heat or smokes.

Do not disassemble or maintain this product because the internal high voltage circuit may cause the electric shock.

Please take out all the batteries if this product is not used for a long time.

Features

- **Completely Compatible with YONGNUO 622C and 603 Wireless System**

YN685 II supports respectively receiving wireless triggering signal from YN650EX-RF/YN320EX/YN560 IV/YN660/YN720/YN560-TX (Pro)/RF605/RF603(II)/ YN622C-TX/YN622C. It can easily realize wireless TTL, manual flash and stroboscopic flash. Note: The wireless TTL flash function requires the support of the main control unit.

- **Remote Control Off-camera Parameters of Each Group**

The flash mode, flash intensity, focal length and sync mode (YN622C wireless system only) of the speed-lite in each group can be controlled remotely through YN622C transceiver and YN650EX-RF/YN320EX/YN560IV/YN660/YN720/YN560-TX(Pro).

- **High Speed Sync (HSS)**

When HSS function is activated, this speed-lite YN685 II can be used with every shutter speed and the maximum sync speed is up to 1/8000s. Note: The camera and transceiver should support HSS function .

- **Supports Firmware Upgrade**

The YN685 II equipped with USB interface, supports firmware upgrade, you can download the upgrade firmware through the YONGNUO official website to upgrade the flash.

- **Ultrafast Charging Recycle System, supporting External Power Supply**

The recycling time is 2 seconds when the power output is set to maximum. The recycling time is about 3~4 seconds even this speed-lite is used without using fresh batteries. In addition, you can use the external power supply to meet your higher charging recycle need.

- **Supports Auto/Manual Zooming**

YN685 II supports auto and manual zooming, and the flash coverage can be changed between 20~200mm.

- **GN60@ISO100,200mm;supports TTL, M and Multi mode.**

- **Supports Sound Prompt Function, Custom Settings (Fn.) and Auto Save Settings**

- **Equipped with Big Size LCD Display Screen, standard PC Synchronous Interface**

Catalogue

Precaution	P1
Features	P2
Quick Start	P4
Components Description	P5~9
Preparation	P10~11
Basic Functions	P12~15
Advanced Applications	P16~19
Wireless Flash Shooting	P20~23
Custom Function Setting	P24~25
Troubleshooting Guide	P26~27
Specifications	P28~29

In order to get familiar with this product, please read this user manual and take the user manuals of the camera and YN622C/YN622C-TX as reference.

Icon in this user manual:



:warning of avoiding shooting problems.

Basic assumption:

- * Both the camera and this speed-lite are assumed to set as <ON> in every operating steps.
- * Without otherwise specified, this product defaults to using 4 AA batteries and all the setting values are based on the testing standard of YONGNUO Company.

Quick Start

If you don't have much time to read the whole user manual, we advise you to read this section.

1. Please avoid the excessive user of the output with maximum power. It can effectively extend the service life of this product. (It is recommended that the speed-lite should be idle for more than 5 minutes when the overheat protection is activated.)
2. Short press [MODE] button to switch the flash mode among E TTL mode, M mode and Multi mode; Press and hold [MODE] button to switch trigger mode between normal set-up trigger mode and wireless off-camera trigger mode.
3. The specific function of the functional buttons (1-4) will be different according to the current flash working state. For more details please refer to the following chapters.
4. Short press [SYNC] button to turn on/off HSS or second curtain sync function.
5. Short press [Zm/C.Fn] to enter into the flash coverage area setting state; press and hold [Zm/C.Fn] to enter into the custom flash function setting stage.
6. Short press [Gr] button to set the groups of the off-camera speed-lite.
7. The selected flash parameter such as flash intensity, flash coverage range and flash channel can be changed through [Select Dial]; save the parameter settings by short pressing [OK] button.
8. Press and hold the function button 4 to turn on/off the backlogt.
9. Long press button 2 and button 3 to restore the shooting function settings and wireless shooting parameters to default settings; please note that the custom settings won't be cleaned.
10. In the shutdown state, keep pressing the [MODE] button and then power on to enter the firmware upgrade interface.

Components Description

1.Nomenclature

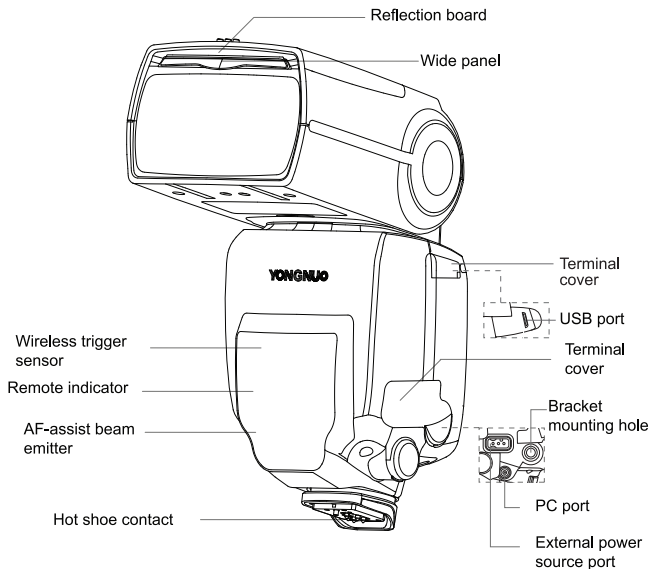

Components Description

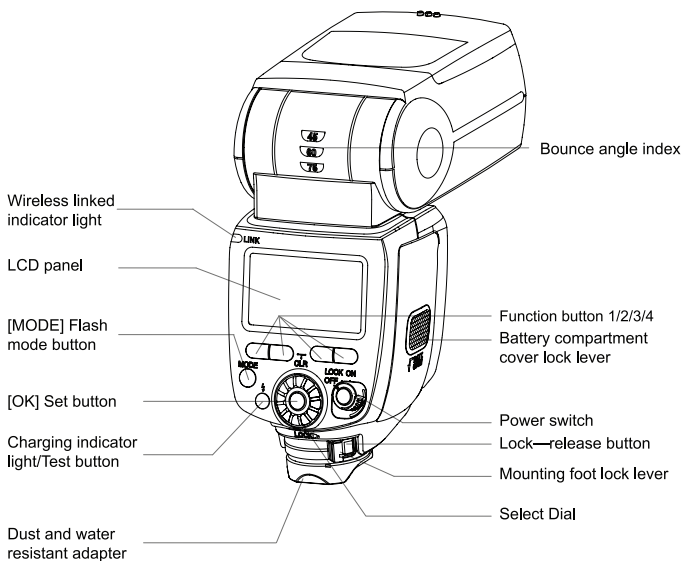

2.LCD panel

ETTL flash LCD panel

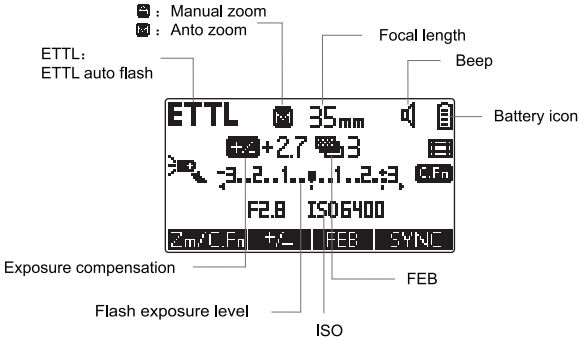

M mode LCD panel display

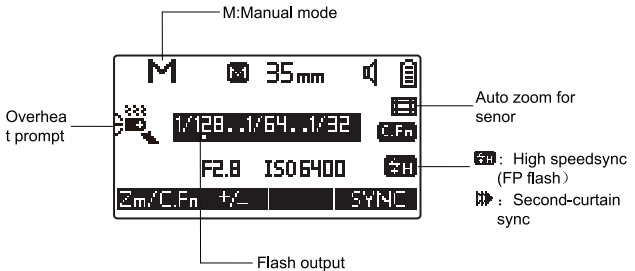

Multi mode panel display

MULTI: Stroboscopic flash

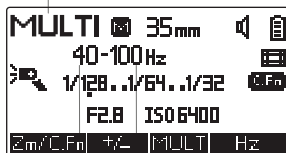

Flash frequency

Number of flashes

Off-camera mode panel display

Slave icon

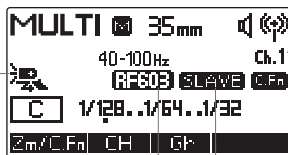

wireless shooting

Channel

Slave

622 REMOTE : 622 REMOTE CONTROL MODE

622 MIX : 622 MIX CONTROL MODE

RF603 : RF603 MODE

3.Indicators

Status of [Charging Indicator

Status of Charging indicator	Meaning	Method
Red light	The speed-lite is fully charged and can be used.	Normal
Blue light	The speed-lite has not been fully charged	Waiting for completion of charging.
Blue light blinking	Low battery and the speed-lite is about to shut down.	Please replace new batteries.
Red light blinking	Overheat prompt	Reduce the frequency or stop firing until the speed-lite cool down.
Red light and blue light	Overheat protection mechanism is activated.	Stop firing until the speed-lite cool down.

LINK Indicator

Status of LINK Indicator	Meaning	Method
Blue light	In the communication	Normal
Red light	be triggered	Normal

4.Sound Prompt

The sound Form	Meaning	Method
Tick twice	The sound indicator is enabled, and the speed-lite is started and ready to fire.	Normal
Three tick, two times	The exposure may be excessive.	Adjust exposure compensation or change shooting condition.
Tick tick tick	The exposure may be insufficient.	Adjust exposure compensation or change shooting condition.
Tick-tick Tick-tick twice	The speed-lite is charging.	Waiting for completion of charging;
Tick-a long sound	The speed-lite is fully charged and can be used.	Normal
Continuous and quick ticks	Low battery and the speed-lite is about to shut down.	Replace the batteries.
Tick-tick-tick	Auto power off after sleep	Restart the flash

Preparation

1.Install Batteries

Slide the [battery compartment cover] in the direction of the arrow as shown.

Insert the batteries according to the label inside the battery chamber and make sure the direction of the battery contact (+/-) is correct.

Close the [battery compartment cover] in the direction of the arrow as shown.

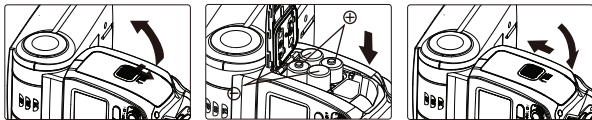

NOTE: Please use four standard specification AA batteries. To avoid circuit, please do not use damaged batteries.

2.Attaching to the Camera

Slip the speed-lite's [mounting foot] all the way into the camera's hot-shoe. Slide the [mounting foot lock lever] to the right side as the arrow shown until the "clicks" sound is heard.



3.Detaching from the Camera

To detach the speed-lite from the camera, press the [lock-release button] and slide the [mounting foot lock lever] to the left side, then detach the speed-lite.

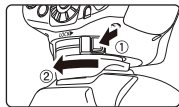

4. Power-on and Power-off

Set the switch to <ON> position, the speed-lite is on and starts charging; after turned on, the <Charging Indicator> is bright with red light which indicates it can flash.

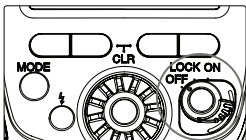

If the battery power is too low, the <Charging Indicator> will be blinking with blue light, the screen displays the low power icon and shutdown automatically. If so, it indicates the speed-lite needs to be replaced with new batteries.

After use, set the switch to <OFF> position to turn off the power source. Please take out the batteries after turning off the power of the speed-lite.

5. Lock Function

Set the switch to <LOCK> position, [Select Dial] and other buttons of this speed-lite will be locked. With this function, the setting parameters defined will be protected from being changed accidentally. When this function is enabled, the LCD screen displays <LOCKED>.

6. Test Flash

When the charging indicator turns red, you can test the flash is normal or not through [TEST] button.

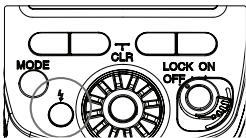

Basic Functions

1.ETTL Mode

In E TTL mode, the metering system of this camera will detect flash illumination reflected back from the object so as to automatically adjust the exposure compensation. In E TTL mode, the light intensity can be adjusted by setting FEB, FEC and exposure lock.

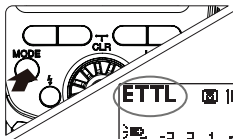

2.M Mode

Short press [MODE] button to switch this speed-lite to M mode and you can set flash output according to your requirement. The adjustment range of flash output is 1/128~1/1. Short press functional button [+/-], after the flash output is highlighted, adjust the flash output through [Select Dial], and then save settings by pressing [OK] button.

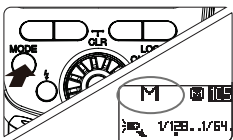

3.Multi Mode

By short pressing [MODE] button this speed-lite is switched to Multi mode; then set flash output, flash frequency and number of flashes according to your requirement. Short press [+/-] button to select flash output, [MULT] button to select number of flashes and [Hz] button to select flash frequency. After the selected items are highlighted, set the parameters through [Select Dial] and save the settings by pressing [OK] button. The adjustment range of flash

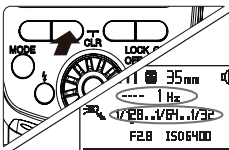
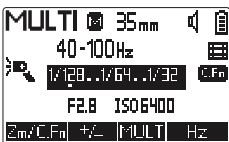

output is 1/128-1/64-1/32-1/16-1/8-1/4; the number of flashes range and flash frequency range is 1~100. When the number of flashes is set as "---", this speed-lite will keep flashing till the shutter closed

or the batteries run out.



when in low battery, the charging speed of speed-lite will be slow, which may cause the leakage of the stroboscopic flash. In this situation, please reduce the flash frequency or change new batteries.

4. Wireless Slave Mode

Long press the [MDOE] button to switch the trigger mode, when the screen displays <SLAVE> and <Ⓜ> icon, it means entering into off-camera mode. One YN685 can

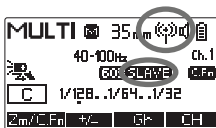

receive the wireless trigger signal from YN650EX-RF/YN320EX/YN560TX(Pro)/YN622C/YN622C-TX/YN560IV/RF605/RF603(II) respectively. Through YN650EX-RF/YN320EX/YN560IV/YN560-TX(Pro)/YN622C-TX can remote control the flash mode, flash output, focal length and sync mode of each group of flash. Details for the setting method please refer to “Wireless flash shooting” instruction.





Only when the trigger supports this function can it remote control each group of the flash parameter through the trigger.

5. Menu Access of Camera

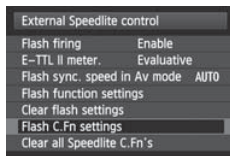
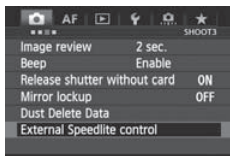
When this speed-lite is used with Canon EOS digital camera released since 2007, flash function and custom function can be set from camera menu. For the operation of the camera please refer to the user manual of the camera.



6.Power Saving Mode

We have designed the power saving mode for YN685. When power saving mode is enabled, the speed-lite will go to sleeping mode if it leaves idle. <  > or <  > will

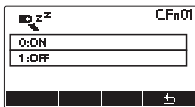

display on the LCD screen when it's in sleeping mode, you can wake up this speed-lite by short pressing [TEST] button. For more specific settings please refer to “Custom Function Setup” (P.24) .

7.Overheat protection

If this speed-lite is used too frequently, the temperature of the flash head will rise.

When the inner temperature of this speed-lite rise, the overheating prompt will be displaying on the LCD screen.

When the overheating level goes to level 2 and the speed-lite keeps flashing, the overheat protection will be activated; the overheat protection icon <  > will be displayed on LCD panel and the charging indicator will alternately flashes blue and red light. When the overheat protection is activated, this speed-lite can't fire until it's idle for 15 minutes or more till cools down.



- When the speed-lite warns overheating, please reduce the use intensity.
- Please mind the hot batteries when you take them out after the continuous shooting.

8.Modeling Flash

Operate the aperture preview button on the camera, the speed-lite will flash continuously for 1 second. This is so-called modeling flash.



Please keep the number of modeling flashes under 10 times; keep the speed-lite idle for 10 minutes or more after the continuous use of modeling flashes to prevent this speed-lite from overheating or burning-out.

9.PC Sync Port (input)

YN685 is equipped with standard PC sync port. Through connecting to the PC sync port, this speed-lite can be triggered synchronously.

10.Automatic Setting Saving

This speed-lite will automatically save the current settings; this is convenient for you to use the speed-lite next time.

11.Clear Settings

By pressing both button 2 and button 3 for 2 seconds, the flash settings will be restored to default settings except the custom function settings.

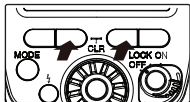

For more details about how to restore the custom function settings please read the chapter <Custom Function Setting> (P24).

12.Firmware upgrade

This product supports firmware upgrade. Users can log in to YONGNUO official website <https://www.hkYONGNUO.com/xzyzc> to download the latest upgrade software and firmware to upgrade the flash. The upgrade method is:

- 1.Connect to the computer via a micro USB cable (micro USB cable needs to be purchased separately).
2. When the flash is off, press and hold the [MODE] button and turn it on to enter the upgrade interface.
3. Open the upgrade software and follow the software prompts to upgrade.

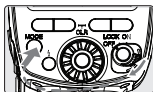
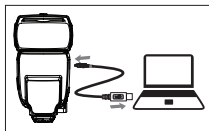

Advanced Applications

1.High-speed Sync Flash

With high-speed sync (FP flash), the flash can be synchronized with all shutter speeds, the maximum shutter sync is up to 1/8000. High-speed synchronization is particularly convenient to use aperture priority to fill flash for the portraits.Short press the function button **【SYNC】** to turn on or off the high-speed synchronous flash,when the function enabled,the flash screen will display  icon.

2.Second-curtain Sync

After the second-curtain sync enabled,the speedlite will flash at the moment when the shutter is going to be shut.Use the slow-speed shutter and second-curtain sync can make image tail for the shooting subject.Short press the function button **【SYNC】** to enable or disable the second-curtain sync, the flash screen will display  icon when the function enabled.



The second-curtain sync function can only be used when it is supported by your camera, about whether the camera supports this function please refer to the camera manual.

3.Flash Exposure Compensation

In order to make the shooting effect more suitable to your needs,you can set the flash exposure compensation through the camera or on the speedlite. The exposure compensation value range is within the range of $-3EV \sim +3EV$,the increment with 1/3 or 1/2EV.Short press the function button **【+/-】** to choose the exposure compensation amount,rotate the **【Select Dial】** to adjust the exposure compensation,then press the **【OK】** button to save settings.



The compensation setting on the speedlite will overlap the exposure compensation setting on the camera; about the exposure increment setting method please refer to the camera manual.

4.Exposure Bracketing (FEB)

The exposure bracketing can be set within the range of $-3EV \sim +3EV$ and increment with $1/3$ or $1/2EV$ through the speedlite or camera. After the exposure bracketing being set, after every 3 photos being taken, exposure compensation will be made automatically, for example, exposure in the sequence of “normal→under→over”. This function helps you improve the success rate of photo taking. The exposure bracketing setting method: short press the function button **【FEB】** to select the exposure bracketing, rotate the **【Select Dial】** to adjust the exposure bracketing, then press the **【OK】** button to save settings.



- When using the exposure bracketing, we suggest you set the driving mode of the camera as “single shot”, and check if the flash is in full charge before shooting.
- Through the custom C.Fn 03 can enable or disable the exposure bracketing automatic cancel function. If enabled, the exposure bracketing will be canceled automatically after 3 photos are taken (P24).
- Through the custom C.Fn 04 can choose the exposure bracketing sequence (P24).



5. FE Lock

To use this function, cover the subject for which flash exposure will be locked at the center of the viewfinder of camera, press the button **【*】** of the flash exposure lock, and the flash light will pre-flash and the camera will calculate the appropriate flash output data. At this point you have some time for recomposition, after it you can take photo by pressing the camera shutter.



The function can only be used when it is supported by your camera. For the setting method please refer to your camera manual.

6.The Flash Range Setting

You can set the flash range to “Auto zoom” or “Manual zoom”. When set to “Auto zoom”, the flash will automatically adjust the flash range according to the focal length. When set to “Manual zoom”, you can set the flash range between 20mm ~ 200mm. Short press the **【Zm/C.Fn】** button to choose the flash range value, then adjust the flash range through the **【Select Dial】**, press the **【OK】** button to save settings. The icon  means auto zoom, while the icon  means manual zoom.

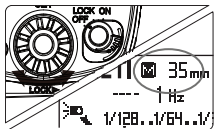
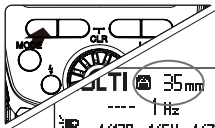

When using the [wide panel], the flash range will expand to 14mm, and the focal length will be locked.

7. Use the External Battery Pack

You can purchase the external battery pack SF-18C or SF-17C, connect it to the external power socket of YN685, after flash the battery pack will charge for the speedlite.

8.High-speed Continuous Shooting

The speedlite can support the high-speed continuous shooting function. Please set the camera in the continuous shooting mode and then shoot.



When using the [wide panel], the flash range will expand to 14mm, and the focal length will be locked.

9.Reflection Flash

Bounce flash means taking photos by making flash light head aimed at wall or ceiling and using the light reflected back from the ceiling

or wall to light the desired object. So that the shade behind the object can be lightened to get more natural shooting effect.

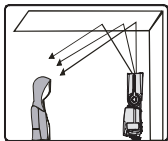

If the wall or ceiling is too far, the bounce flash may be too weak to get enough exposure. The wall or ceiling should be even and white in order to get efficient reflection; if the reflection surface is not white, color cast may appear in photo.

10. Use Reflection Board for Shooting

When using the [Reflection board] in flash, pull the [Reflection board] and the [Wide panel] out from the light head, then push back the [Wide panel]. If shooting in such case, it will produce a highlighted point on the eyes of the subject and thus make the eyes charming (catching light).

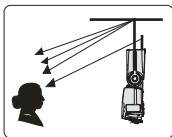

This function can reach better effect if adjusting the flash head up to 90°.

11. Use Wide Panel

Pull out the [Wide panel], push back the [Reflection board] and arrange them as per the figure; in such case, the flash range will extent to 14 mm, the flash range will be enlarged and the effect will be softer and more natural.

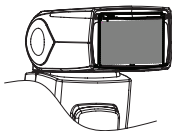

Note: When the [Wide panel] being pulled out, the flash range will be locked to 14mm and unadjustable.

Wireless Flash Shooting

YN685 II is compatible with the wireless system of YN650EX-RF/YN320EX/YN560-TX(Pro)/YN622C-TX/YN622C/Y N560 IV/RF605/RF603 II and RF603 II respectively,easy to realize off-camera TTL、M、multi flash among multi flashes.Besides,under the support of flash trigger, it can remote control the flash mode,flash output,focal length and synchronization method of each group of flash.

Long press the [MODE] button can switch the trigger mode:ordinary set-top on camera→622R.SLAVE→ 622M.SLAVE →603 SLAVE→ordinary set-top on camera.Through the custom C.Fn 24 it can setup the trigger mode switch sequence as requirement,for details please refer to the custom section.



- partial function of the wireless flash shooting need to setup on the master unit,the relevant settings of master unit please refer to the manual of the trigger.
- In the triggering process please make sure the channel of the master unit and slave unit are consistent.
- If you want to realize adjusting the flash coverage of each slave unit through the master unit,the slave unit must be set to "Automatic Zoom"state first.

1.622C Wireless System

When the YN685 II work with the YN622C-TX or YN622C for wireless flash shooting,please switch the flash to 622 REMOTE or 622 MIX state by long pressing the [MODE] button.

When the YN685 II in the YN622C wireless trigger system,there are total 7 channels and 3 groups for option.Through short press the function button [CH] could enter into the channel setting state,

through the [Dial] can adjust the channel,press the [OK] button for

saving. Short press the function button [Gr] can directly switch the grouping from slave unit.

You can choose YN685 as default remote control mode(622 REMOTE)or mix mode(622 MIX) through the master unit.



622 REMOTE CONTROL MODE

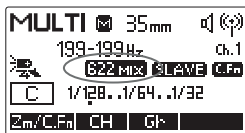

622 MIX CONTROL MODE

(1) Remote Control Mode

The remote control mode of YN685 II is compatible with: ①the master unit is YN622C-TX; ②the master unit is YN622C,and the YN622C has been enabled the remote control mode.

When the YN685 II set to remote control mode,the flash mode,flash output and synchronization method are completely controlled by the master unit. The flash coverage can set on the device or through the master unit.

(2) Mix Mode

The mix mode of YN685 II is mainly suitable for:the master unit is YN622C,and the YN622C has been enabled the mix mode.

The flash mode and flash output of YN685 II which has been set to mix mode state can be set on the flash but not controlled by the master unit,the setting method is the same as ordinary set-top on camera trigger mode.

2.RF603 Wireless System

When the YN685 II work with the RF603 wireless system for wireless flash shooting,please long press the [MODE] button to switch the flash to "603 SALVE" state.



YN685 II can receive the wireless trigger signal from YN560 IV / YN560-TX/RF605/RF603II/RF603 respectively, realize off-camera M、Multi flash or not participate in flash.

When the YN685 II in the RF603 wireless trigger system, there are total 16 channels and 6 groups for option. Short press the function button [Gr] can switch the grouping directly; through short pressing the function button [CH] could enter into the channel setting state, through the [Dail] can adjust the channel, short press the [OK] button for saving. The setting method of the flash mode, flash output and focal length under 603 slave state are the same as ordinary set-top on camera trigger mode, the setting method through the master unit please refer to the manual of master unit.

3. Multi-flash Wireless Flash Configuration

You can create two or multiple slave groups to realize shooting multiple needs. In the shooting process, you can set TTL flash, manual flash and stroboscopic flash for each group of slave unit according to your actual shooting demand.

(1) Wireless flash of two slave units made up by YN685 II

Set the trigger mode of off-camera trigger mode of slave unit (P20) .

Setup communication channel: Set the channel of the master unit and slave unit in consistent.

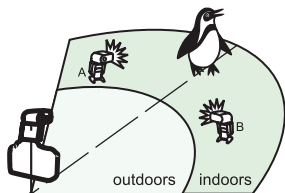

Group setting: Set the two YN685 II to any two groups of group A/B/C/D/E/F respectively.

The flash parameters setting of slave unit: If the slave unit set to 622 remote control mode, then through the master unit or camera menu to remote control the flash mode, flash output, synchronization method and flash range of each group for slave unit. If the slave unit set to 622 mix control mode or RF603 trigger mode, then you can set the flash mode, flash output and flash range on the slave unit.

(2) Wireless flash of multiple slave units made up by YN685 II

The setting method of forming multiple slave unit of wireless flash is same as the setting method of forming two slave unit of wireless flash. However, it can set the slave unit to A/B/C/D/E/F multiple groups respectively. In shooting process it can follow the arrangement of the flash effect as you need.

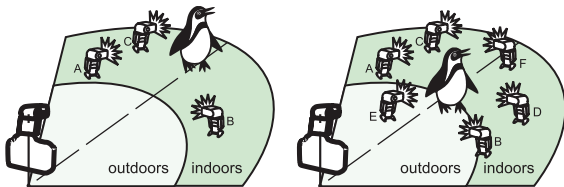

When you need bigger flash output, you can increase the slave unit. Just need to increase slave units on the flash group (A, B, C, D, E or F) if you want to increase the flash output. For example: if you need to increase the flash output of group A, please set the three slave units as group A, then the three flash is equivalent to controlling flash on the flash group A.

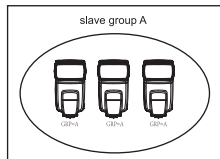

Custom Function Setting

You can custom the flash function according to your requirement. Long press the function button **【Zm/C.Fn】** to enter into the custom function menu, rotate the **【Select Dial】** to select the custom function item (Number, such as C.Fn 01), short press the **【OK】** button to enter into the submenu, change the function settings through the **【Select Dial】**, short press the **【OK】** button for save settings. After the custom function setting completed, press the **【Return】** button back to the shooting interface. When function button **【clear】** and then function button **【OK】** are pressed on the Custom Function screen, the Custom Functions which have been set are cleared.

The custom function supported by YN685 II is as below:

C.Fn 00 Theme

- 0: NUMERIC Numeric theme
- 1: CLASSIC Classic theme

C.Fn 01 Power saving mode

- 0: ON Enable the power saving mode
- 1: OFF Turn off the power saving mode

C.Fn 03 Exposure bracketing auto Cancel

- 0: ON Enable the exposure bracketing auto cancel
- 1: OFF Turn off the exposure bracketing auto cancel

C.Fn 04 Sequence of exposure bracketing

- 0: 0→-→+ Sequence of FEB is “0→-→+”
- 1: -→0→+ Sequence of exposure bracketing is “-→0→+”

C.Fn 08 AF-assist beam

- 0: ON Enable the AF-assist beam
- 1: OFF Turn off the AF-assist beam

C.Fn 09 Automatic identification sensor

- 0: ON Enable the automatic identification sensor
- 1: OFF Turn off the automatic identification sensor

C.Fn 10 Power automatic off of the slave unit

0:60min Power automatic off of the slave unit is 60 minutes

1:10min Power automatic off of the slave unit is 10 minutes

C.Fn 11 Slave auto power off timer

0:8h Slave auto power off within 2 hours

1:1h Slave auto power off within 1 hours

C.Fn 20 Sound prompt

0: OFF Turn off sound prompt

1: ON Enable sound prompt

C.Fn 22 LCD backlight

0:12sec The display time of LCD backlight is 12 seconds

1: OFF Turn off the background light

2: ON Background light long on

C.Fn 25 Slave unit indicator light

0: ON Enable the slave unit indicator light

1: OFF Disable the slave unit indicator light

C.Fn 26 Contrast control

You can adjust the display contrast, total of 15 levels for option.

C.Fn 27 Background Brightness

You can adjust the background brightness, total of 28 levels for option.

C.Fn 28 Firmware Version

Display the information of current version for the flash.

Troubleshooting Guide

1.Unable to turn on the power source or unable to flash

Please ensure the battery in correct installation;Ensure the hot shoe contact between flash and camera are in good contact;Please clean the contact if the hot shoe contact of flash and camera got dirty.

2.The flash automatically shut off the power

Please check if the flash enable the power saving mode or whether the battery power is enough.

3.Photo underexposed or excessive

Check if the shutter speed,aperture,ISO too close to the flash limit or have set the relevant setting of the exposure compensation,exposure bracketing and etc;on the premise of the flash not beyond the flash limit,if the exposure effect is still not ideal,please appropriate increase or decrease the exposure compensation or flash output;when enable the high-speed synchronization,the effective flash range will become shorter,please close to the object.

4.At the bottom of the pictures appears dark

When the flash close to the shooting object,please adjust the vertical rotation angle of flash head to -7° .

5.The image edge appears dark

When the flash using manual zoom,please set the flash range wider than view angle (P18) .

6.The slave unit does not flash

Please check whether the channels of slave unit and master unit are accordant or not;please ensure the slave unit is in the effective flash range of master unit;check if the master unit set the group of slave unit as not participate the flash.

7. Other abnormal phenomenon

Try to clear the settings of flash and camera; try to disable the flash power source and then restart the flash. If the problem still not be solved, please contact to YONGNUO after-sale service center with hot line 400-001-3888.

Specifications

Circuit design:	Insulated Gate Bipolar Transistor (IGBT)
Guide No:	60 (ISO 100, 200mm)
Flash mode:	ETTL,M, Multi
Trigger mode:	Set-top,wireless off-camera
Zoom Range:	AUTO. 20,24,28,35,50, 70,80,105,135,200mm
Vertical rotation angle:	7~90 degrees
Horizontal rotation angle:	0~360 degrees
Power supply:	4×AA size batteries (Alkaline or Ni-MH battery)
Lighting times:	100~1500 times (AA alkaline cell used)
Recycle time:	Approx 3s (AA alkaline cell used)
Color temperature:	5600k
Flash time:	1/200s~1/20000s
Flash control:	8 levels of output control (1/128~1/1), total of 22 levels of fine tuning
External interface:	External power interface, PC port , hot shoe
Wireless trigger distance:	100m
Additional features:	High-speed sync, second-curtain sync, FEC, FEB, FEV, the electronic flash head zooming, sound prompt, automatically saving setting,power saving mode, overheat protection,custom function setting
Dimensions:	67×77×210mm (Extended state)
Net weight:	426g
Contains items:	Speedlite(1), protecting bag (1), mini stand (1) ,manual (1)

Guide Number (ISO 100, in meters/feet)

Flash Output	Flash Range (mm)					
	14	20	24	28	35	50
1/1	15/49.2	26/85.3	28/91.9	30/98.4	36/118.1	42/137.8
1/2	10.6/34.8	18.4/60.4	19.8/65	21.2/69.6	25.5/83.7	29.7/97.4
1/4	7.5/24.6	13/42.7	14/45.9	15/49.2	18/59.1	21/68.9
1/8	5.3/17.4	9.2/30.2	9.9/32.5	10.6/34.8	12.7/41.7	14.8/48.6
1/16	3.8/12.5	6.5/21.3	7/23	7.5/24.6	9/29.5	10.5/34.4
1/32	2.7/8.9	4.6/15.1	4.9/16.1	5.3/17.4	6.4/21	7.4/24.3
1/64	1.9/6.2	3.3/10.8	3.5/11.5	3.8/12.5	4.5/14.8	5.3/17.4
1/128	1.3/4.3	2.3/7.5	2.5/8.2	2.7/8.9	3.2/10.5	3.7/12.1

Flash Output	Flash Range (mm)				
	70	80	105	135	200
1/1	50/164	53/173.9	58/190.3	59/193.6	60/196.9
1/2	35.4/116.1	37.5/123	41/134.5	41.7/136.8	42.4/139.1
1/4	25/82	26.5/86.9	29/95.1	29.5/96.8	30/98.4
1/8	17.7/58.1	18.7/61.4	20.5/67.3	20.9/68.6	21.2/69.6
1/16	12.5/41	13.3/43.6	14.5/47.6	14.8/48.6	15/49.2
1/32	8.8/28.9	9.4/30.8	10.3/33.8	10.4/34.1	10.6/34.8
1/64	6.3/20.7	6.6/21.7	7.3/24	7.4/24.3	7.5/24.6
1/128	4.4/14.4	4.7/15.4	5.1/16.7	5.2/17.1	5.3/17.4

The electronic version manual can be downloaded from

<http://www.hkyongnuo.com/s-ourproduct.php?category=1>.Flash.

The functions and data in this manual are based on the test conditions of our company.

Further notice will not be given if the design and specifications change;

The YONGNUO logo in this manual includes the registered trademark or trademark of **SHENZHEN YONGNUO PHOTOGRAPHY EQUIPMENT Co., Ltd** in China or/and other countries (regions). All other trademarks are the property of their respective owners.