

Warning

To avoid fire or electrical shock, do not expose this product to rain or moisture.

To avoid short circuit, please sure the batteries contacts are securely packed and in accordance with local provisions when handling the battery.

Please place the batteries and the parts which can be swallowed mistakenly away from children. Contact a doctor immediately when it occurs.

To avoid possible injury to eyes, do not use the flash light in a short distance from the eyes.

To avoid possible safety accident, do not use the flash light on the people who need a high degree of attention.

Please take out the batteries and stop using immediately in case of below.

- This product is dropped or shocked seriously and the inner part of the product is bared.
- If the battery leaks corrosive liquids, please take out the battery with gloves.
- The product gives off strange smell, heats or smokes.

Do not disassemble or maintain this product. Touching the internal high voltage circuit will cause electric shock.

Please take out all the batteries if not use this product for a long time.

Features

● Supports USB Firmware Upgrade

Equipped with USB port, please visit YONGNUO official website to download the latest firmware and update the flash to ensure the best compatibility and performance of the flash.

● COMPATIBLE WITH N's and C's WIRELESS FLASHING SYSTEM

One YN565EXIII is able to accept the internal flashing of YN600EX-RT II,YN568EX II,580EX II,SB-900/800/700,7D/60D/600D,C order of N's internal flashing and wireless signal of ST-E2,supports 4 channels,achieves external TTL and manual flashing.

● TTL FLASH WITH HIGH GUIDE NUMBER

GN58@ ISO100, 105mm; supports TTL、M、MULTI flash mode.

● MULTIPLE TRIGGER MODE SUPPORTED

YN565EX III can be triggered by the camera set-top,built-in or master control flashing command,S1 and S2 pre-flashing.

● SUPPORT AUTOMATIC/MANUAL ZOOMING

The covered focal length can be varied between auto,24~105mm on the lamp adapter by operating the zoom and adjusting button on the flash light; Supports full-frame and half-frame cameras.

● COMPREHENSIVELY SUPPORTS TTL FUNCTIONS

FEC,FEB,Rear-curtain sync,FE lock,Aperture preview modeling light,Canon camera menu accessible.

● HIGH SPEED RECYCLING SYSTEM

It just takes 2 seconds to finish a charging cycle after a full level output,you can also use external power

pack to accelerate the charging speed.

- **PROVIDES CHARGING SOCKET FOR EXTERNAL POWER PACK**

YN565EX III provides charging socket for external power pack, to meet your higher demand for charging recycle.

- **PC PORT PROVIDED**

Allow you more easy to make the flash synchronously by using the PC sync line.

- **SOUND PROMPT SYSTEM**

When the sound prompt system is enabled, different sound modes will prompt different working conditions of the speedlite so as to allow you to focus on shooting process.

- **APERTURE PREVIEW MODELING LIGHT FUNCTION**

Press the aperture preview button, the YN565EX III will send out continuous flash which lasting one second for modeling light.

- **ADVANCED OPTION SETTINGS**

YN565EX III is equipped with advanced options setting function, where you can customize the functions of the speedlite according to your shooting preferences.

- **AUTOMATIC SETTINGS SAVING**

YN565EX III can automatically save your current operating settings to convenient your next use.

- **LCD PANEL USER INTERFACE, ELEGANT APPEARANCE**

- **WITH SOLID AND RELIABLE METAL HOT-SHOE STAND**

Quick Start

If you don't have much time to read the whole user manual, we advise you to read this section.

1. Please avoid the excessive use of the output with maximum power. It can effectively extend the service life of this product. (It is recommended that the speedlite should be idle for more than 3 minutes when entering the overheating protection.)
2. You can operate each buttons and observe the changes of the displayed content to understand their respective functions.
3. Short press the [ZOOM] button to enter the focal length adjustment and wireless parameter settings. Long press the [ZOOM] button to enter the trigger mode selection state.
4. Long press the [Fn] button can set the advanced options function of the flash, the setting details please refer to the section of 'Advanced Options Setting'.
5. The flash can be operated through the 'External Flash Function Setting' through the Canon camera menu.
6. Press the [UP],[DOWN],[LEFT] and [RIGHT] buttons can quickly adjust the parameters of speedlite at the current mode. For some parameters, the central [OK] button is need to press several times for setting.
7. This product provides ETTL/M/MULT mode, which can be switched through the [MODE] button.
8. Press [MODE] button and 3 together to restore the flash parameter of the speedlite to default setting (trigger mode, flash mode, flash output, focal length)
9. In power-off mode, press and hold [MODE], then turn on the speedlite to enter firmware upgrade interface.

COMPONENTS DISCRPTION

- 1.Reflection board
2. Wide-angle diffuser
- 3.Flash head
4. Micro USB port
5. External power socket (It can be connected to the SF-18C or SF-17C Flash Battery Pack)
- 6.PC port (for input)
- 7.Port cover
8. Wireless trigger sensor
- 9.Battery door
10. AF-assist light
11. Locking ring
12. Hot shoe stand
13. Hot shoe contact
14. Sound port

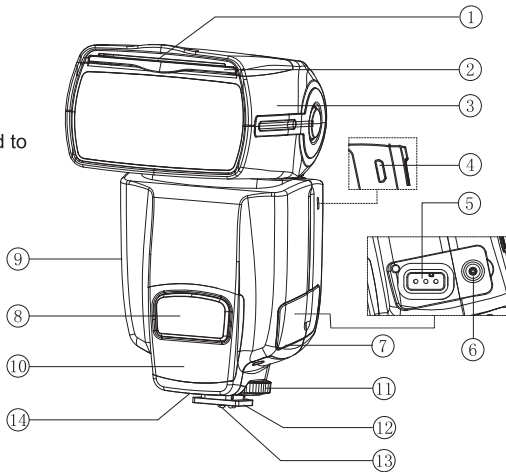

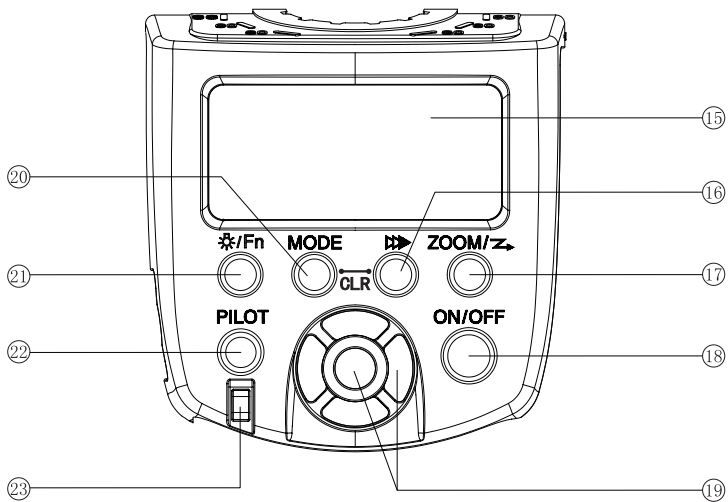

15. LCD screen: Displays all functions and application setting of the speedlite, convenient for users' examination and quick setting.
- 15.Rear curtain sync shortcut button: The flash will be switched between rear/front curtain sync by each pressing.
- 17.Zoom/trigger mode button: Short press the [ZOOM]button to enter the focal length adjustment and wireless parameter settings. Long press the [ZOOM]button to enter the C selection state.
- 18.Power switch (ON/OFF): Press this button for about 2 seconds to turn on or off the power of speedlite.
19. Selection/setting button set: Including the [Left],[Right],[Up],[Down] and central [Ok] button; Through the buttons can set output power, exposure compensation, exposure bracketing, stroboscopic flash times, stroboscopic flash frequency, focal length range, slave unit, communicate channel and slave grouping and etc.
20. Mode switch button : the flash mode will be switched between TTL/M/Multi by each pressing.
- 21.Blacklight/ Advanced options button: A short press will turned on or off the backlight; Long press the button can enter into the advanced options setting state of the flash.
- 22.Charge indicator/Test button (PILOT): Red light indicates charging is completed and flash can work; blue light indicates charging is being on, and press this button, the speedlite will emit test flash.
23. Flash exposure confirm indicator light: When the flash used on set-top, the flash exposure confirm indicator light will shine for about 3 seconds when getting the standard flash exposure.

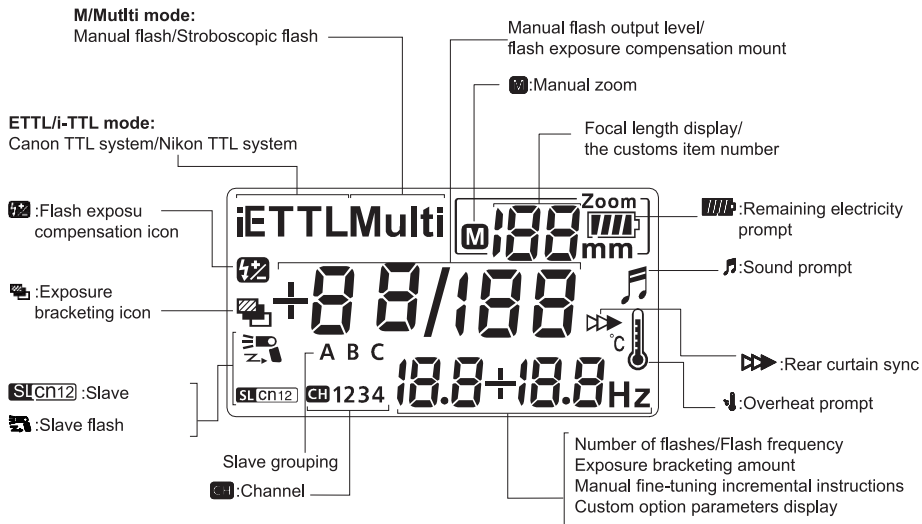

Power Recycle Indicator

Status of Indicator	Meaning	Method
Red light	The speedlite is fully charged and can be used.	Normal
Blue light	The speedlite has not been fully charged.	Waiting for completion of charging.
Blue light blinking	a.Low battery; the speedlite is about to shut down. b.Overheat prompt	a.Replace batteries. b. Reduce flash frequency or stop using the speedlite until it cools down.
Red light blinking	Overheat prompt	Reduce flash frequency or stop using the speedlite until it cools down.
Red light and blue light blinking	Overheat protection mechanism is activated.	Stop using the speedlite or shut down the speedlite until it cools down.

Sound Prompt

The Sound Mode	Meaning	Method
Tick twice	The sound indicator is enabled,the speedlite is started or flash is ok.	Normal.
Three ticks, two times	The exposure maybe excessive.	Adjust exposure compensation or shooting condition.
Tick tick tick	The exposure may be insufficient.	Adjust exposure compensation or shooting condition.
Tick-tick tick-tick tick	The speedlite is in the charging.	Waiting for completion of charging.
Tick-a long sound .	The speedlite is fully charged, and can be used.	Normal.
Sound in rapid succession	The power is not enough and the speedlite is going to be shut down.	Replace the batteries.
Tick-tick-tick-	The speedlite is going to be shut down.	Restart the speedlite.

Installation Instruction

1. Install Batteries

Slide the Batteries door in the direction of the arrow.

Insert the batteries according to the label inside battery door and make sure the direction of the batteries' polarity is correct.

Close the battery door in the direction of the arrow.

Note:Please use four standard specification AA batteries. To avoid circuit please do not use damaged batteries.

2. Attaching the flash to the Camera

Loosen the locking ring by rotating it in the direction of the arrow.

Slip the speedlite hot shoe stand into the camera hot shoe stand until it stops

Tighten the locking ring in the direction of the arrow.

To detach the speedlite,loosen the locking ring,then push it from the camera hot shoe.

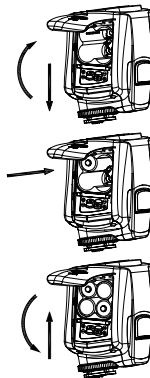

Basic Functions

1. Power-on and Power-off

The power of the speedlite can be turned on or turned off by long pressing the [ON/OFF] button. It is recommend that the batteries should be taken out after turned off the speedlite through this button.

After turning on the power of the speedlite,the [PILOT] indicator light is red,which indicates the speedlite is available.

If in low battery, the screen will display the low battery icon,the speedlite will automatically shutdown,indicating it need to change new batteries.

You can press the [PILOT] button to test whether the speedlite works normally. After use,turn off the speedlite by long pressing the [ON/OFF] button for about 2 seconds.

2.ETTL Mode

In this mode,the metering system of this camera will detect flash illumination reflected back from the object so as to automatically adjust the flash output,then the subject and background get balanced exposure.Supports exposure compensation,exposure bracketing,rear-curtain sync,exposure lock,modeling light,Canon camera menu access function and etc.

You can set exposure compensation by pressing the[Left] and [Right] buttons of the flash,the flash exposure compensation range is $-3\text{ev} \sim +3\text{ev}$,in 1/3-stop precision.

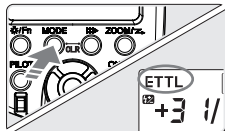
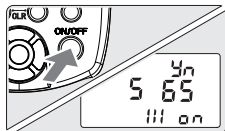

3. M Mode

In M mode, you can set flash brightness according to your preferences, and adjust flash brightness by the [Left], [Right], [Up] and [Down] buttons. Adjustment range of flash brightness is 1/128~1/1, and the brightness can be divided into 8 grades, each has maximum three grades for fine adjustment, and takes mixing grade 0.3EV as adjustment increment, totally 22-grade fine adjustment at most; adjust whole grade brightness with the [Left] and [Right] button, and make fine adjustment with the [Up] and [Down] button, and the adjustment result will be shown on the LED screen. When shooting, you only need to set flash brightness, adjust the camera and press the shutter; the speedlite will flash according to the sync signal of the camera.

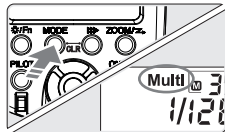
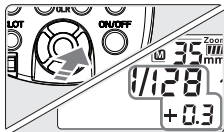
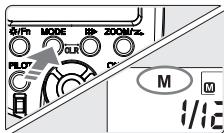

4. Multi Mode

In Multi mode, a rapid series of flashes is fired. The speedlite will flash according to the output power, flash times and frequency you set. Use the [Left] and [Right] buttons to adjust output power, flash times and frequency. The adjustment scope of output power is 1/128-1/64-1/32-1/16-1/8-1/4, the scope of flash times is from 1 to 100, and the scope of flash frequency is from 1 to 100. Adjustment method: press the [OK] button to start the

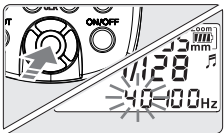

flash, and use the [Left] and [Right] buttons to adjust the flash frequency. After the setting is completed, press the [OK] button to confirm the setting. The flash times will begin to flash, use the [Left] and [Right] buttons to adjust the flash times.

NOTE: The charging speed of speedlite will be related slow when the speedlite in low battery, which may cause the leakage of the stroboscopic flash. In this case, please reduce the flash frequency or change new battery.

5. Off-camera flash mode (Sc/Sn and S1/S2 Mode)

Enter the wireless status by long pressing the [ZOOM], then operate the [LEFT] and [RIGHT] buttons to choose Slave (four off-camera modes Sc/Sn/S1/S2 for option) when the screen display and blink 「OF」. The press the [OK] button to confirm and save the setting. (four off-camera modes Sc/Sn/S1/S2 for option) The four off-camera modes Sc/Sn/S1/S2 can be used as off-camera slave unit in order to create multiple lighting effects.

Sc/Sn mode can separately accept YN600EX-RT II、YN568EX II、580EX II、SB-910/900/800/700、7D/60D/600D built-in flash, Nikon camera C-command, SU-800 and ST-E2 wireless signal, supporting 4 channels and realizing TTL and manual wireless flash. When using Sc/Sn and S1/S2 mode, wireless trigger sensors can be adjusted to face master lamp by rotating speedlite holder. Before shooting, slave unit and master unit should be set at same communication channel. Setting method: Operate the [ZOOM] button to select CH flash, then choose 1/2/3/4 by pressing

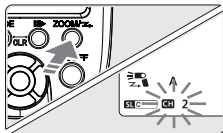
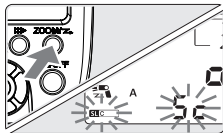

the [LEFT] and [RIGHT] buttons. In Sc/Sn mode, the flash mode and flash output of the slave unit will be totally controlled by master unit.

S1 and S2 modes are suitable for MANUAL flash environment and TTL flash environment respectively. Under these two modes, operating the [LEFT] and [RIGHT] buttons to adjust the output brightness is like that in M mode.

S1 mode: In this mode it will work with the first flash synchronously of the master flash, with the result consistent with the use of radio slave. To use this mode properly, the master flash should be set at manual flash and should not use the TTL flash system, pre-flash function and the red-reduction function with multiple flashes.

S2 mode: It is also called 'pre-flash cancel mode'. This mode is similar with S1 mode, but it can neglect the pre-flash given by TTL flash. Therefore, it can support the master flash working in TTL mode. In particular, if S1 mode cannot flash properly and synchronically with your internal flash, you can try to use S2 mode.

Note: The following situation shall be avoided when the S1 and S2 modes are used: the red eye reduction function of the main light is used; the order mode (Nikon) or wireless mode (Canon) of the main light is used; the ST-E2 is used as the flash controller. Otherwise, please set the speedlite to Sc/Sn mode.

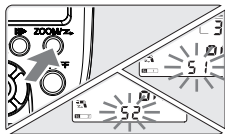

6.Menu Access of Camera (only for the newer Canon models)

You can control the speedlite by accessing to camera menu on the newer Canon models which support E-TTL. On the Flash Control Menu, you can set relevant parameters through 'External flash func. setting' and 'External flash C. Fn setting', for example, switch the E-TTL mode, manual flash mode and MULTI Flash mode, Rear-curtain Sync, Exposure bracketing, exposure compensation, focal length and advanced setting etc.

7. Test Flash

No matter in which mode, you can press the [PILOT] button to test if the speedlite flash normally. When testing the flash, the speedlite will give flash at relevant output level in accordance with the chosen output power setting.

8. Power Saving Mode

YN565EX III is equipped with power saving mode, and the mode can be achieved by setting advanced options function. For example, turn on/off the power saving function: long press the [Fn] button to enter into the setting state, and then select the option numbered 01 with the [Up] and [Down] buttons, set the state to be 'SL EP - -' with the [Left] and [Right] buttons, means the 'Automatic power off' function is closed, and when the state is 'SL EP on', means the 'Automatic power off' function is enabled.

In dormant state, the screen will display 'SE', the flash can be waken by [PILOT] button.



9. Overheating Protection

If the speedlite is used too frequently, the overheating protection function will be triggered; the OVERHEATING indicator will be displayed on LCD panel. And the speedlite will be locked. In such case, please wait for about 10 to 15 minutes before continuing use. Please try to use 1/4 output or lower when rapidly shooting is needed to prevent the effect on the shooting.



Note: when continuous shooting, the charge indicator will be warn by a red light flashing as the flash internal temperature rises to a certain value; At this time, the flash recycling time will be extended, and it is recommended to appropriately reduce the use intensity of the flash.

10. Flash cover range setting

Auto Zoom: short press the [ZOOM] button until the focal length value displays on LCD panel, then adjust the coverage through the [Left] and [Right] button. When it does not displays <M> in the left of the <ZOOM> icon, attach the speedlite to the camera, the flash coverage will change as the lens focal length and move back and forth to accommodate different flash coverage (the default is 35mm).

Manually Set the zooming position: Press [ZOOM] button to select focal length value, and adjust the focal length value with [RIGHT] or [LEFT] button. When <M> displays at the left side of [ZOOM] icon, the flash coverage (24, 28, 35, 50, 70, 80, 105mm) can be manually adjusted.

11. Sound Prompt

When the sound prompt function is enabled, the speedlite will give out different sound to indicate the working state. Besides, the sound prompt can be turned on or off through the advanced options setting as needed.

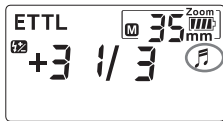
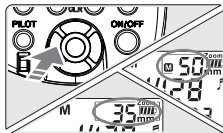
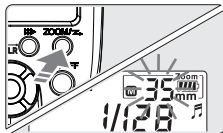

12.Imaging flash

Operate the aperture preview button on the camera,the YN565EX III will make one second continuous flash,which is modeling light.

Note:Please try to control the continuous modeling lights under 10 times;After the operation of consecutive imaging flash,the flash need to idle for 10 to 15 minutes to avoid overheating or damage of the flash lamp holder.

13. PC Sync port (for input)

By connecting to the PC sync port,you can make the flash synchronously.

14. Automatic Setting Saving

The speedlite will automatically save the current settings,which convenient to your next boot.

15.Clear the Flash Settings

Press the [MODE] button and [Rear-curtain sync] button for around two seconds, except the custom function Settings,the flash parameters including the trigger mode, flash mode, flash output, and focal length will be restored as default Settings.

Note:To restore the custom function settings,please refer to the custom settings section.

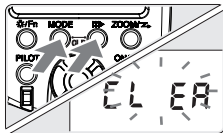

16.Firmware Upgrade

The product supports firmware upgrade,the user could log on the official website www.hkyongnuo.com to download the most updated software and firmware for upgrade. The method is as follow:

- 1) Connect the computer with the Micro USB cable.
- 2) When the speedlite is turned off,hold the [MODE] button and enter into the upgrade interface.
- 3) Turn on the upgrade software,follow the software and upgrade operation.

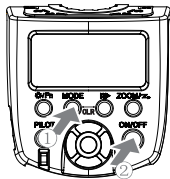

U P

Optical transmission wireless flash shooting

YN565EX III is fully support wireless flash system,one YN565EX III is able to accept internal flash of YN600EX-RT II 、 YN568EX II、 580EXII、 SB-900/ 800/700、 7D/60D/600D,C-commander of Nikon build-in flash and ST-E2 wireless signal at the same time,to achieve wireless TTL of multiple flashes and manual flash.

Sc: Indicating that it can only receive wireless signal from Canon system,avoiding Nikon system.

Sn: Indicating that it can only receive wireless signal from Nikon system,avoiding Canon system.

1. Master Unit Setting

The master unit adopts YN600EX-RT II、YN568EX II、580EXII、SB-900/800/700、7D/60D/600D build-in flash,C-commander of Nikon build-in flash and ST-E2 wireless signal; the relevant setting method please refer to the operation instruction of the master unit.

2.Slave Unit Setting

Long press the [ZOOM] button for two seconds,when the screen displays [OF],it means the unit have entered into wireless slave unit state. Through the [LEFT] and [RIGHT] buttons to set the slave unit SLAVE (four off-camera modes Sc/Sn/S1/S2 for choose),choose a trigger mode,then press [OK] button to save the setting.

For the four off-camera modes of YN565EX III,Sc / Sn is equipped with 3 groups (A,B,and C) respectively and four communication channels (1,2,3,4).When the YN565EX III as the slave unit,in Sc/Sn mode,through short press the [ZOOM] button to choose the focal length,channel,grouping option.The selected option will blink,then you can set the relevant parameters through short pressing the [LEFT] and [RIGHT] button.

When the YN565EX III set to Sc/Sn mode,the flash mode,flash light ratio,exposure compensation,exposure bracketing,flash lock,manual flash output,stroboscopic flash and other parameters setting will be totally controlled by the master unit. That is to say,you can just set the related parameters on the master unit.

3.Multi-flash,Wireless flash Configuration

You can create two or three slave groups to make better shooting effect to meet your requirements.

<1>Wireless flash of two slave units made up by YN56EX III.

- Wireless option setting: Sc/Sn for operation.
- Communication Channel setting: 1,2,3,4
- Groups setting: Set one YN56EX III as group A,and set the other one as group B.
- Master unit setting: Set the communication channel; Set the flash ration of master unit A: B or A: B: C. You can conduct flash shooting.

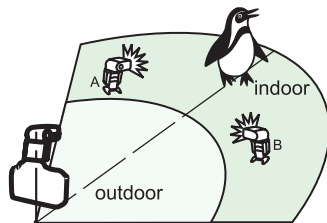

<2>Wireless flash with three slave unit made up by YN56EX III.

- Wireless option setting: Sc/Sn
- Channel setting: 1,2,3,4
- Groups setting: Set three YN56EX III speedlites as group A,group B and group C respectively.
- Setting master and shooting: Setting communication channel;The master control unit of the flash ratio as <A: B C>.

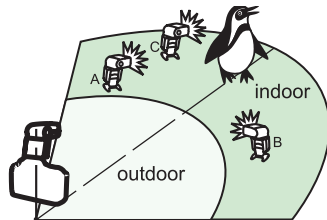

Press the test button of master unit to test whether the flash works normally or not; if the slave unit does not fire, adjust the angle of the YN565EX III toward the master unit and distance from the master unit.

NOTE: If the master unit set to <A: B> is set, then set the slave unit in group C will not fire.

If you have set the three YN565EX III to slave group <A>, all the three slave units will be controlled by one speedlite in slave group A.

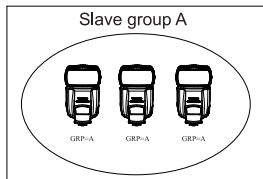

4. Shooting Examples with Wireless Flash System

- Master unit: YN600EX-RT II/YN568EX II/600EX-RT/580-II, SB-900/800/700, 7D/60D/600D with built-in flash, C-commander of Nikon's, SU-800 and ST-E2.
- Slave unit: YONGNUO EX series flash with slave unit flash function, which can be created three slave groups at most.
- Use the mini flash stand (tripod socket provided) to prop up the slave unit YN565EX III.
- Rotate the slave unit YN565EX III to make its wireless sensor faces the master unit.
- Indoors, the wireless signal can also be bounce off the wall so there is more leeway in positioning the slave unit(s).
- After positioning the YN565EX III, be sure to test the wireless flash operation before shooting.
- Do not place any obstacles between the master unit and slave unit(s). Obstacles can block the transmission of wireless signals.

Advanced Applications

1. Remote Wireless Flashing Shooting

YN565EX III can receive remote wireless signal. The longest distance used indoors is up to 25 meters and up to 15 meters used outdoors.

Please note that the wireless sensor of the YN565EX III should be face to master unit, and make sure that the YN565EX III located within the effective range of transmission of the master unit.

2. Flash Exposure Compensation

In order to make the shooting effect more suitable to your needs, you can set the flash exposure compensation through the camera or set on the flash.

The compensation exposure value can be adjusted through the [LEFT] and [RIGHT] buttons on the YN565EX III. Every press of the button, the compensation value will be displayed on LCD panel. The setting range of flash exposure compensation is $-3\text{ev} \sim +3\text{ev}$, in $1/3$ stop increment.

Note: For the Canon version, the compensation exposure set on the flash will cover the value set on the camera.

3. Exposure Bracketing (FEB)

The FEB function is set through the camera or speedlite. After the FEB is set, after every 3 photos are taken, exposure compensation will be made automatically in the sequence of 'normal , under , over'. This function helps you improve the success rate of photo taking.

Through the [up] and [down] buttons of YN565EX III can directly adjust the bracketing exposure value.

NOTE: For FEB,set the drive mode of camera to 'single shot'; Be sure the flash is ready before shooting.

4.Rear- curtain Sync

You can use slow-speed shutter to produce trailing smear for the object and the flash light will flash at the moment when the shutter is going to be shut,which means the rear-curtain sync function .(For the rear-curtain sync setting,refer to your camera manual for setting). You can turn on or off the rear-curtain sync by pressing the [Rear-curtain sync] hotkey on panel of YN565EX III.

NOTE: When YN565X II is used as wireless flash,the rear-curtain sync function cannot be set on the flash directly.

5.FE Lock (Canon)

To use this function,cover the subject for which flash exposure will be locked at the center of the viewfinder of camera,press the button <*> of the flash exposure lock,and the flash light will pre-flash and the camera will calculate the appropriate flash output data. Now you have some time for recomposition,after it you can take photo. (The function can only be used when it is supported by your camera. For the setting method,refer to your camera manual.)

6.FV Lock (Nikon)

Set the <AE-L/AF-L> function as FV Lock on the camera before using this function. At this time,you can aim at the object in the viewfinder and then press the <AE-L key or AF-L> key,in such case,the flash light will pre-flash to get the reading of flash exposure for the object; after you have confirmed the scene frame,press the shutter. (The function can only be used when it is supported by your camera. For the setting of <AE-L and AF-L>,refer to your camera manual).

7. Advanced Options Setting

YN565EX III is equipped with advanced options function,you can customize speedlite function as you need,set advanced options with button group of the speedlite or camera menu access. Setting method of the speedlite:Long press the [Fn] button to enter into the advanced options function setting state,the screen will displays the setting items. The advanced options items can be changed through short pressing the [UP] and [DOWN] buttons,and the parameters can be changed through the [LEFT] and [RIGHT] buttons. For example: <SE of 3> means used on the set-top,the speedlite will automatically sleep if it is idle for 3 minutes,and automatically power off if it is idle for another 3 minutes after sleep.

Advanced options function supported by YN565EX III is as following:

Fn NO.: 01

SL EP on: Auto power off is enabled

SP EP - - : Auto power off is disabled

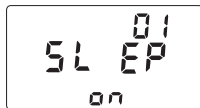

Fn NO.: 03

Fb CL on: FEB auto cancel is enabled

Fb CL - - : FEB auto cancel is disabled

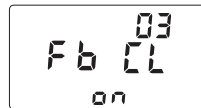

Fn NO.: 04

Fb 0 - +: Sequence of FEB is '0→-→+'

Fb - 0 +: Sequence of FEB is '-→0→+'

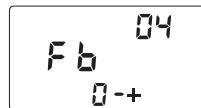

Fn NO.: 08

AF on: AF-assist light is enabled

AF - - : AF-assist light is disabled



Fn NO.: 09

AP S A1: Automatic identification enabled

AP S - - : Disabled

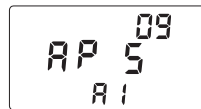

Fn NO.: 10

SL Sd 10: Power automatic off of the slave unit is 10 minutes

SL Sd 60: Power automatic off of the slave unit is 60 minutes

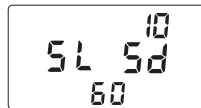

Fn NO.: 11

SL oF 1H: Slave auto power off cancel within 1 hours

SL oF 8H: Slave auto power off cancel within 8 hours

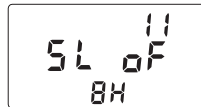

Fn NO.: 20

So nd on: Sound prompt function is enabled

So nd - - : Sound prompt function is disabled

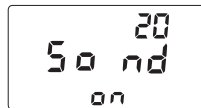

Fn NO.: E1

SE of 3/5/10/30/1H/2H/3H/4H/5H: Keeping idle for 3/5/10/30 minutes or 1/2/3/4/5 hours will enter the dormancy mode, after it enters the sleep state, it powers off automatically after keeps the same idle time.

SE of - - : NO dormancy, NO automatically turn off.

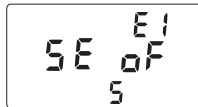

Fn NO.: E2

qu ic - - : Quick turn on / shut down function is disabled

qu ic on: Quick turn on / shut down function is enabled

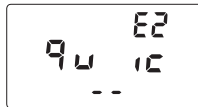

Fn NO.: E3

L cd 7/15/30: The display time of LCD backlight is 7/15/30 seconds

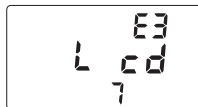

Fn NO.: E4

CL EA - - : Recover the default settings(long press [OK] button can restore the default Settings

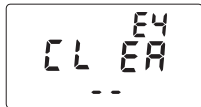

Fn NO.: E5

Display the information of current version for the flash.

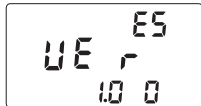

8. Use the External Charging Pack

You can purchase the Yongnuo external charging pack SF-18C or SF-17C,connect it to the charging port of the YN565EX III. After the flicker shown,the charging pack will charge the flash.

9.High-speed Continuous Shooting

The flash supports the high-speed continuous shooting function. Please set the camera in the continuous shooting form and then shoot.

Note: The quantity of photos that can be continuous shot is related with the brightness setting. Please use the fully charged battery.

10. Reflection Flash

Bounce flash means to take photos by making flash light head aimed at wall or ceiling and using the light reflected back from the ceiling or wall to light the desired object,so that the shade behind the object can be decreased to get more natural shooting effect.

If the wall or ceiling is too far,the bounce flash may be too weak to get enough exposure. The wall or ceiling should be even and white in order to get efficient reflection; if the reflection surface is not white,color cast may appear in photo.

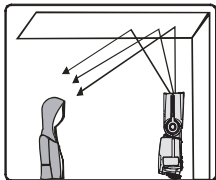

11. Use Reflection Board to Take Photos

With the reflection of board flash,pull out the reflection board and the wide-angle diffusion board out from the light head at the same time and then push the wide-angle diffusion board back. In such case,if this product is being used to take photos,it will produce a highlighted point on the eyes of the subject and thus make the eyes charming (catch light). This function can reach optimal effect when the flasher head is up 90°.

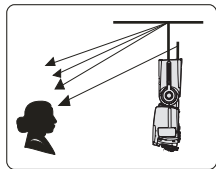

12. Use Wide-angle Diffuser

Pull out the wide-angle diffusion board,push back the reflection board and arrange them as per the figure; in such case,the effect will be softer and more natural.

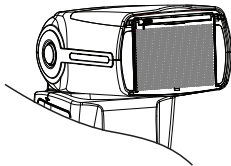

Possible problems during use and solutions

1. The YN565EX III can't flash

Check whether the batteries is installed in the correct orientation: Please install the batteries in the correct orientation.

Check whether the speedlite is attached to the camera: Slip the speedlite hot shoe stand into the camera hot shoe stand hard.

Check the hot shoe contact: Clean the contacts.

Check whether the batteries is exhausted: If the charging is not completed within 20 seconds,the flash will automatically shutdown. Then you need to replace with new batteries.

2. YN565EX III can't work as slave unit

Check the slave unit setting: The YN565EX III must be set to SLAVE.

Check the slave unit's situation: Please position the YN565EX III(s) within the master's wireless transmission range. Adjust the slave unit's angle toward the master unit and distance from the master unit.

3. Underexposure or overexposure of photo

● Check whether the shutter,aperture and sensitivity (ISO) of camera are set too close to the limit of flashing,or whether the exposure compensation,exposure bracketing and other settings relative with flashing are correct.

● Because of the differences among different types of cameras and the personal preference, you may meet the whole overexposure or underexposure when using this product, and so try to adjust it through the flashing compensation or exposure compensation.

4. You must set the FEB every time?

You can access FEB setting through camera menu or lock FEB setting through Fn advanced option setting to avoid that FEB will cancel automatically when completing three shooting tasks. The number of setting option is 03. It is ok to set the 'FEB auto cancel' disabled.

5. Overexposure of photo

Please check whether the FEB sequence is set as '-→0→+'. You can change the FEB sequence to '0→-→+' through menu accessible or advanced setting. Or enable the FEB auto cancel.

6. Vignetting appears in photos or only part of the subject is illuminated?

Please check the current coverage of focal length and make sure if the lens focal length exceeds the coverage range of the flash. The product's zooming range is 24~105mm of the medium format system.

7. The state of YN565EX III is abnormal.

Please try to turn off the power supply YN565EX III and camera. After YN565EX III is installed on the hot shoe of camera, turn on the power supply again. If it is still unusual, please replace the batteries.

Specifications

Circuit design	Insulated Gate Bipolar Transistor (IGBT)
Guide No.	58 (ISO 100,105mm)
Flash mode	TTL,M,Multi
Trigger mode	Set-top,Sc,Sn S1,S2
Wireless triggering distance	20~25m indoor,10~15m outdoor
Flash coverage	auto、24、28、35、50、70、80、105mm
Vertical rotation angle	-7~90 degrees
Horizontal rotation angle	0~270 degrees
Power supply	4×AAsize batteries (Alkaline or Ni-MH are usable)
Lighting times	100~1500 times (AA alkaline cell used)
Recycle time	Approx 2s (AA alkaline cell used)
Color temperature	5600k
Flash time	1/200s~1/20000s
Flash control	8 levels of output control (1/128~1/1),22 levels of fine tuning
External interface	hot shoe,PC port ,external charging port
External power supply	can be connected to SF-18C or SF-17C charging pack
Additional features	Rear-curtain sync,FEC,FEB,exposure lock,modeling light,lamp holder manual zoom,auto zoom,sound prompt,advanced option,automatically saving setting,PC port,power saving mode,over heat protection.
Dimensions	60×190×78mm (Extended state)
Net weight	380g
Contains items	Flash light (1),protecting bag (1),mini stand (1), manual (1)

Guide Number of different focal length range (at ISO 100,in meters / feet)

Flash Output	Flash Coverage (mm)							
	14mm	24mm	28mm	35mm	50mm	70mm	80mm	105mm
1/1	15/49.2	28/91.9	30/98.4	39/127.9	42/137.8	50/164	53/173.9	58/190.3
1/2	10.6/34.8	19.8/65	21.2/69.6	27.6/90.7	29.7/97.4	35.4/116.1	37.5/123	41/134.5
1/4	7.5/24.6	14/45.9	15/49.2	19.5/64	21/68.9	25/82	26.5/86.9	29/95.1
1/8	5.3/17.4	9.9/32.5	10.6/34.8	13.7/45.2	14.8/48.6	17.7/58.1	18.7/61.4	20.5/67.3
1/16	3.8/12.5	7/23	7.5/24.6	9.7/32	10.5/34.4	12.5/41	13.3/43.6	14.5/47.6
1/32	2.7/8.9	4.9/16.1	5.3/17.4	6.9/22.7	7.4/24.3	8.8/28.9	9.4/30.8	10.3/33.8
1/64	1.9/6.2	3.5/11.5	3.8/12.5	4.9/16	5.3/17.4	6.3/20.7	6.6/21.7	7.3/24
1/128	1.3/4.3	2.5/8.2	2.7/8.9	3.5/11.4	3.7/12.1	4.4/14.4	4.7/15.4	5.1/16.7

The electronic version of this manual can be got on.

The functions of this manual are based on test conditions of our company. Further notice will not be given if the design and specifications change;

The YONGNUO logo in this manual includes the registered trademark or trademark of SHENZHEN YONGNUO PHOTOGRAPHY EQUIPMENT Co.,Ltd in China or/and other countries (regions). All other trademarks are the property of their respective owners.