



HATSAN
ARMS COMPANY

Serious. Solid. Impact.



⚠ WARNING: NOT A TOY. THIS AIR GUN IS RECOMMENDED FOR ADULT USE ONLY. MISUSE OR CARELESS USE MAY RESULT IN SERIOUS INJURY OR DEATH. DANGEROUS WITHIN 600 YARDS (550 METRES).

⚠ WARNING: ONLY USE CLEAN, DRY COMPRESSED AIR TO FILL THIS AIRGUN. THE USE OF CONCENTRATED OXYGEN (O₂) OR OTHER GASES CAN CAUSE FIRE OR AN EXPLOSION WHICH MAY RESULT IN SERIOUS INJURY OR DEATH, AND MAY CAUSE DAMAGE TO THE PRODUCT.

VECTIS SERIES

INSTRUCTION MANUAL

PLEASE READ THIS MANUAL BEFORE USING YOUR AIR GUN

CONTENTS	PAGE
GENERAL INSTRUCTIONS	3
SPECIFICATIONS	4
BASIC PARTS OF YOUR GUN	4
MANUAL SAFETY	5
QUATTRO TRIGGER	5
LOADING THE RIFLE & SHOOTING	6
MAINTENANCE	7
SAFETY MEASURES & WARNINGS	8

Thank you for choosing HATSAN Vectis Series PCP air rifle.

Always use caution when operating this rifle. Learn and obey the laws of your local municipality, state, and/or country. Demonstrate responsibility while using this air rifle. **Please read this manual completely before handling or shooting your air gun.** It is the sole responsibility of the user to operate this air gun properly and safely.

Warning!

- **Each Hatsan PCP air rifle contains pressurized air when in use and should only be dismantled by a competent gunsmith. Do not attempt to dismantle the rifle if the rifle is partially or fully charged. Otherwise, serious damage/injury/death may be caused to you or others. The air rifle may also become damaged. Never attempt to dismantle the air cylinder parts or air gauge when the air cylinder is fully or partially charged. Serious injury/death/damage may result if these instructions are ignored because pressurized air is in the air cylinder.**
- **Use only factory manufactured pellets that are no longer than the thickness of the rifle's magazine. Do not use BB ammunition with your rifle.**
- **Hatsan PCP air rifles are designed specifically for use with clean, dry compressed air. NO OTHER GAS OR GAS COMBINATION CAN BE USED. The use of concentrated oxygen (O₂) or other flammable/reactive gas is expressly prohibited - as fire or explosion may occur, resulting in serious injury or death and/or damage to the product.**

The rifle may be filled from a diver's bottle or a suitable compressor. MAXIMUM SAFE WORKING PRESSURE (SWP) : 200 BAR (2,900 PSI).

GENERAL INSTRUCTIONS

Removable folding sights are included, and can be used if no scope is desired. Before using your new air rifle check that it is fully charged and abide the following basic safety rules:

Basic Safety Rules:

- Treat every rifle as if it is loaded.
- Never point the rifle at anyone, or allow anyone to point a rifle at you, even if you know it is not loaded.
- Do not brandish or display this product in public – as it may confuse people and could be mistaken as a firearm.
- Always carry the rifle so that the direction of the muzzle is under control, even if you stumble.
- Always be sure of your target and what lies behind it before firing your rifle – this product may be dangerous up to 650 yards.
- Beware of targets that tend to cause ricochets.
- Never leave a loaded rifle unattended.
- It is compulsory that eye & ear protection is worn when charging the cylinder and when shooting.
- This is a high-powered airgun for use by those 16 years of age or older.

Section I. SPECIFICATIONS

Model		Vectis		
Caliber		4.5mm / .177cal	5.5mm / .22cal	6.35mm / .25cal
Max. Muzzle Velocity (*)		325m/s (1070fps)	295m/s (970fps)	265m/s (870fps)
Energy (*)	Joules	30	42	46
	ft. lbs	22	31	34
Magazine Capacity		14	12	10
Air Tube Volume		165cc	165cc	165cc
Fill Pressure		200 BAR	200 BAR	200 BAR
Number of Shots per fill		100	95	90
Number of Shots at Optimal Velocity		48	40	38
Stock		Advanced polymer, Monte Carlo cheekpiece.		
Overall Length		1050mm / (41.3")		
Barrel Length		450mm / (17.7")		
Weight		3.2kg / (7.1lbs)		

* Velocity results may vary as much as 20% due to pellet weight, pellet shape, temperature, elevation, as well as other factors.

* The energy restriction of a particular country can be achieved by the reduction in the muzzle velocity. The above maximum velocity figures are obtained when there is no energy restriction on the air rifle and when measured at optimum pressure value in the air tube. As a nature of PCP air rifles the velocity starts low at maximum pressure level in the air tube, then starts to increase and gets to the maximum at optimum pressure value in the air tube; and then it starts to decrease again as the pressure in the air cylinder gets too low.

Section II. BASIC PARTS OF YOUR GUN

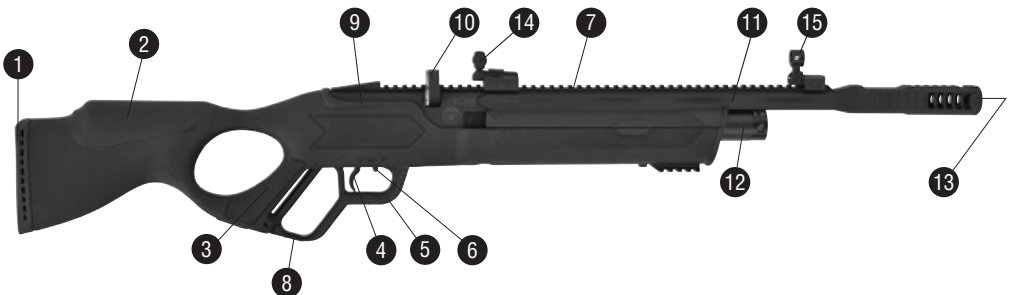

- | | | |
|------------------|------------------|-----------------------|
| 1. Butt pad | 6. Safety button | 11. Barrel |
| 2. Stock | 7. Scope rail | 12. Air cylinder tube |
| 3. Grip | 8. Lever | 13. Muzzle |
| 4. Trigger | 9. Receiver | 14. Rear sight |
| 5. Trigger guard | 10. Magazine | 15. Front sight |

Section III. MANUAL SAFETY



Fig. 1



Fig. 2

Safety button can be set to 'ON' and 'OFF' position manually.

To set the safety to 'ON', pull safety lever to the rear to S position. In this position, the trigger cannot be pulled and the gun cannot be fired. (Fig. 1)

To disengage the safety to 'OFF', push safety lever forward to F position. In this position, the gun is ready to shoot. (Fig. 2)

CAUTION: Until you are actually ready to shoot, keep the safety in the "ON" position (Fig. 1).

Section IV. QUATTRO TRIGGER

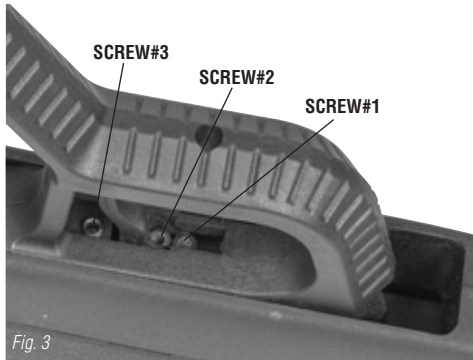

Fig. 3

Your air rifle is equipped with a Quattro trigger, (Fig. 3). You can adjust the "trigger travel" & "trigger pull" as follows:

SCREW#1 is for trigger pull force adjustment. For less trigger pull force prior to discharge, rotate **SCREW#1** clockwise; and vice versa.

SCREW#2 is for trigger travel adjustment. For less trigger travel prior to discharge, rotate **SCREW#2** clockwise; and vice versa.

SCREW#3 is for adjusting the force to pull the trigger until the end of the 1st stage. When this is turned clockwise, this force increases; and vice versa.

NOTE: Make only small changes to one adjuster at a time. Over-adjusting can render the trigger inoperable and may create a dangerous situation!

Section VII. OPERATING INSTRUCTIONS

Warning!

- Before filling the air cylinder; make sure the air rifle is not cocked, safety is in the ON position, no pellets are loaded in the air rifle and/or barrel and magazine is not mounted in the gun. If the air tube is completely empty; fill in air tube after cocking the gun and keeping the cocking handle/bolt open at the rear.
- Take all safety measures before filling the air cylinder. It is compulsory for the user and bystanders to wear eye & ear protection when filling the air cylinder.
- While filling in the air cylinder; the pressure in the air cylinder must be monitored from the air gauge of the hand pump or scuba charging kit. Do not look at the air gauge on the air cylinder during filling process. Instead, reference the gauge on your fill device.

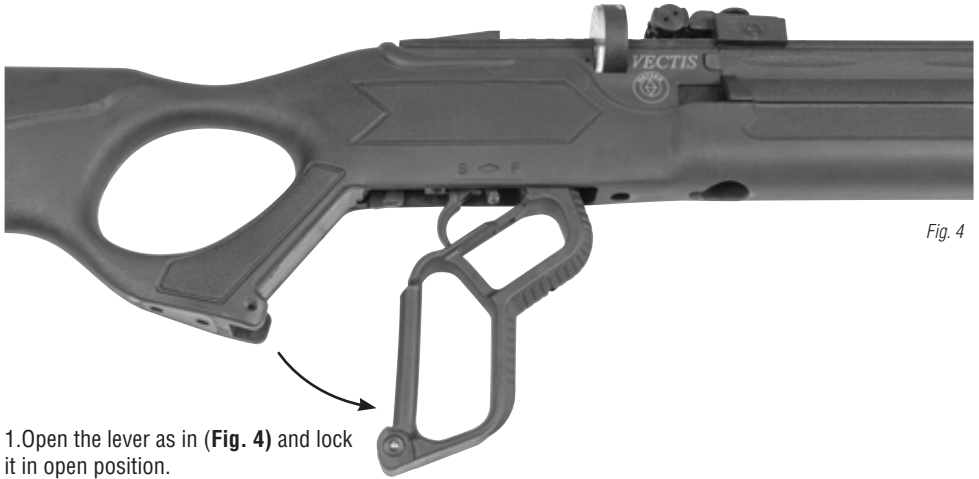

Fig. 4

1. Open the lever as in (Fig. 4) and lock it in open position.

THIS OPERATION COCKS THE TRIGGER MECHANISM/HAMMER ASSEMBLY.

2. Fit the filler nozzle to the air-line of the charging equipment, which must incorporate a pressure gauge. Ensure both filler nozzle and rifle filler hole are clear from dirt and gently push the nozzle into the filler hole. (Fig.5)

Fill the rifle to the cylinder pressure quoted previously in this manual. Do not exceed the maximum fill pressure as this will reduce the velocity of the rifle and may damage rifle components. When using the diver's bottle, refill the rifle slowly to prevent the heat created by the filling process from damaging the rifles components. Undo the bleeder valve on the hose before disconnecting the fill nozzle from the rifle.

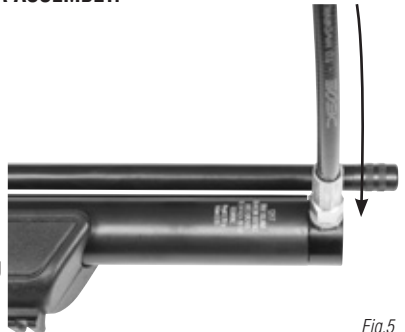

Fig.5

Loading the rifle & shooting

- The magazine is composed of a rear side (transparent part) and a front side (black plastic part). The magazine is designed to be allowed to fit only one way into the rifle.
- Hold the magazine with its plastic side over the transparent side.

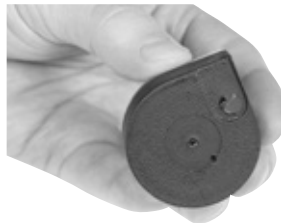

Fig.6



Fig.7

(Fig.6)
3. Spin the black plastic part counter-clockwise to release the cover from the catch point. Then insert the pellet in backwards (skirt first) into the first location.

(Fig.7)
4. Spinning the cover in the same direction and holding the magazine in a vertical position continue placing the pellets until the all positions are filled. Once the magazine is full, spin the black plastic in the opposite direction and return the magazine to its initial position. (Fig.8)

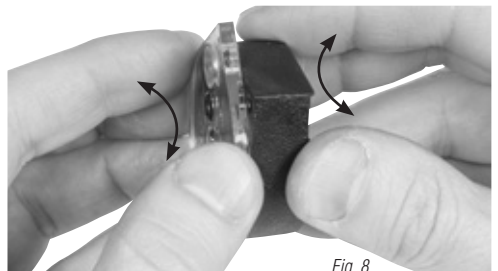

Fig. 8

5. With the transparent cover facing the butt of the rifle insert the magazine from the right side of the rifle and push it inwards all the way in until it's fully in place. (Fig.9 & 10)



Fig. 9

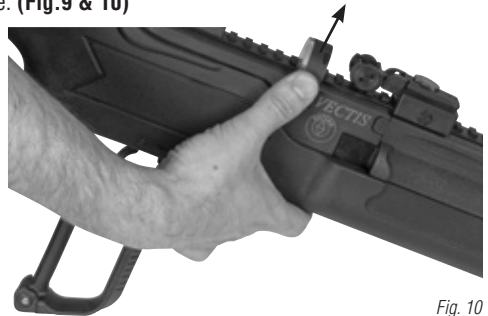

Fig. 10

DO NOT RELEASE THE BOLT LEVER UNTIL YOU ARE READY TO FIRE.

6. Once you are ready to fire, close the lever and lock it in its closed position. (Fig.11)



Fig. 11

7. Aim at your intended target, disengage the safety and get ready to shoot.

8. Pull the trigger gently and the rifle will fire.

9. To reload rifle, open the lever fully and close it back to its original location. Then repeat above steps **7 & 8**.

10. After the last pellet has been fired, the bolt will not close. This will indicate that the magazine is empty.

DO NOT FORCE THE BOLT CLOSED!

Section VIII. MAINTENANCE

Warning!

Never attempt to disassemble this rifle. Never fire the rifle when the air in the cylinder is removed.

Failure to obey this instruction could result in damage to your rifle.

Never lubricate inside the barrel as this will affect the accuracy & grouping of the rifle in negative manner. Occasionally apply proper mineral based oils sparingly to the following parts:

- The trigger mechanism
- The pellet probe
- The cocking lever sliding surface

DO NOT OVER-LUBRICATE THE RIFLE!

- It is recommended to clean the barrel with a cleaning rod every 500-1000 shots. Never lubricate inside the barrel.

- Before you begin oiling or cleaning your air gun, always check to make sure it is unloaded.
- Always be sure your gun barrel is clean and not blocked.
- After cleaning ensure that no cleaning patch or other obstruction remains in the barrel.
- Annually, take your air gun to a gunsmith even if it seems to be working well, since some issues in your gun may not be apparent from external examination.
- Take your air gun to a gunsmith if water, sand, etc. enters the internal mechanism of the air gun, for complete cleaning.
- Dangerous conditions may occur if you do not keep your air gun clean and working properly.

QUICK FILL NOZZLE O-RINGS REPLACEMENT

- After a period of time, the O-rings on the fill nozzle will need to be replaced. The need for the replacement will become noticeable if air is heard leaking from the nozzle or the nozzle is ejected from the port while charging the rifle. Always replace both O-rings.

Safety Measures & Warnings

- This air gun will fire if cocked, loaded, safety disengaged and trigger pulled.
- Air guns are not toys. Never let young children use an air gun unsupervised. Adult supervision is strictly required during use. Misuse or careless use may cause serious injury or death.
- This is a high-powered airgun for use by those 16 years of age or older.
- Learn how your air gun operates and practice safe gun handling procedures before loading and using it.
- **ALWAYS USE EYE & HEARING PROTECTION AND MAKE BYSTANDERS USE THE SAME.** Failure to do so may result in eye injuries and permanent hearing loss.
- Do not point at anything you do not intend to shoot even though the gun is unloaded. Always keep the gun pointed in a safe direction.
- Never pull a gun toward you by the muzzle.
- Always aim at a safe target, taking care that it does not conceal any other object.
- Before you fire, consider where the pellet will travel should you miss your intended target, thus ensuring no damage or harm could result.
- Be sure of your target before you pull the trigger. Never shoot at sounds.
- When shooting, always have a safe shooting range, that is; have a safe area for shooting, a safe distance between you and the target, and a safe backstop to trap the pellets and hold the target.
- Do not fire at a target, which allows ricochets or deflections. Do not fire into or at water.
- Do not fire at or near power lines or insulators. Be especially careful in wooded areas where power lines may not be as visible.
- Do not load the gun until you are ready to shoot.
- Always keep your fingers away from the trigger & muzzle during cocking and handling.

- Do not walk, run or jump when carrying a loaded or cocked air gun. A loaded or a cocked gun should never be carried inside a vehicle, house, camp or public place. Never climb a tree or fence or jump a ditch with a loaded gun. In such a case, first unload it and hand the gun to a friend or place it on the ground on the other side of the obstacle before crossing yourself.
- When transporting the gun, keep it unloaded and 'on safe'.
- Always keep the gun 'on safe' until you are ready to shoot even if the gun is unloaded.
- Do not put the gun away loaded and unattended.
- Always check to see if the gun is 'on safe' and unloaded when getting it from another person or from storage.
- Always keep the air gun and/or pellets out of the reach of children. Keep the air gun and pellets in separate places, better if under lock and key.
- Do not attempt to disassemble or tamper with your gun. Use a competent gunsmith. Many air guns contain powerful springs or high pressure air cylinders which can cause serious injury if released in an uncontrolled manner.
- Always handle and treat your gun as though it were loaded.
- Improper use or handling of air guns is not the responsibility of the manufacturer or distributor, under any circumstances. The user is responsible for any harm, which may be caused.
- Think first, fire second. Don't rely on any mechanical safety. Half safe is not safe.
- Be safe not sorry. Respect other's property.
- Air guns should never be used under the influences of alcohol or drugs.
- Do not brandish or display this product in public – it could confuse people and may be a crime.
- Do not change the coloration and markings to make it look more like a firearm.



Serious. Solid. Impact.

HATSAN

ARMS COMPANY



facebook.com/hatsan.com.tr



twitter.com/hatsan_arms



youtube.com/hatsanarms

www.hatsan.com.tr www.hatsanusa.com