

Precaution

To avoid fire or electrical shock, do not expose this product to rain or moisture.

To avoid short circuit, please sure the batteries contacts are securely packed and in accordance with local provisions when handling the battery.

Please place the batteries and the parts which can be swallowed mistakenly away from children. Contact a doctor immediately when it occurs.

To avoid possible injury to eyes, do not use the flash light in a short distance from the eyes.

To avoid possible safety accident, do not use the flash light on the people who need a high degree of attention.

Please take out the batteries and stop using immediately in case of below.

- This product is dropped or shocked seriously and the inner part of the product is bared.
- This product is dropped or shocked seriously and the inner part of the product is bared.
- The product gives off strange smell, heats or smokes.

Do not disassemble or maintain this product. Touching the internal high voltage circuit will cause electric shock.

Please take out all the batteries if not use this product for a long time.

Features

● Supports USB Firmware Upgrade

Equipped with USB port, please visit YONGNUO official website to download the latest firmware and update the flash to ensure the best compatibility and performance of the flash.

● Compatible With YONGNUO 602/603 Wireless Trigger System

Fully compatible with YONGNUO radio transmission trigger signal of YN720 / YN685 / YN560 IV / YN660 / YN560 III / YN560 TX / RF605 / RF603 / RF602, there are 16 channels available for choice, the effective trigger distance is up to 100m.

● Supports Radio Transmission Slave Function

As slave unit, YN560 III can receive the radio transmission trigger signal from YONGNUO YN720/YN560 IV/YN660/YN560 TX/RF605/RF603/RF602

● Multiple Trigger Synchronous Mode Supported

The YN560 III can triggered through the set top of the camera, 2.4G wireless triggering, S1 and S2 pre flash cancel mode.

● Settings Save Automatically, Supports Custom Settings (Fn)

The parameters on the flash will automatically save when the flash turned off; the users can customize setting the flash function as needed.

- **GN58 @ISO100,105mm**

High Guide Number 2.4G wireless speedlite, supports M/Multi/-- mode.

- **Sound Prompting System**

When the sound prompting system is enabled, the different sound ways will prompt different operating state of the flash so as to allow you focus on shooting.

- **Support Electric Zooming Function**







The flash coverage can be altered between 24~105mm through the [ZOOM] button.

- **Ultra-fast Charging Recycle System, Supports External Power Supply**

- **Equipped with Big Size LCD Display Screen, Standard PC Synchronous Interface**

Quick Start

We advise you to read this section if you don't have much time to read this user manual thoroughly.







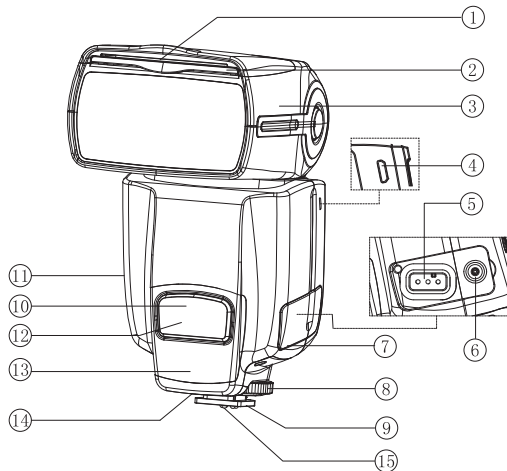

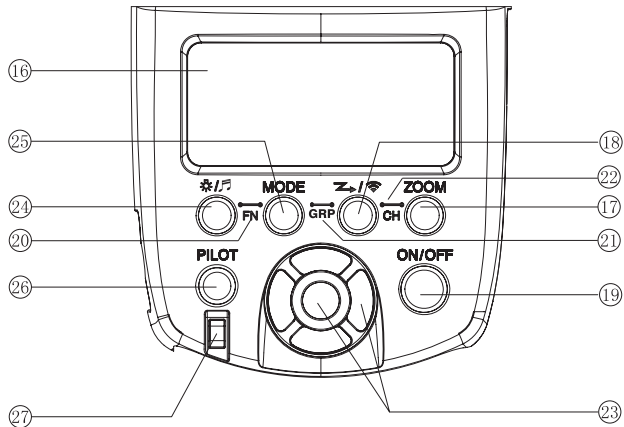



- 1.To effectively extend the service life of this product, please avoid the excessive use of the maximum output power.
- 2.Press the buttons and observe the change on the display screen to learn the respective functions.
- 3.Press [UP][DOWN],[RIGHT]and[LEFT]button to quickly adjust the parameters in current mode. Some parameters should be selected before setting up.
- 4.Press[ / ]to switch the flash modes: set-top mode, RX slave flash mode and S1/S2 flash mode.
5. In RX trigger mode,press[ZOOM]+[ / ]buttons in the meantime to set the channel (CH1~CH16).
- 6.Press[MODE]+[ / ]to enter into “Advanced Option Settings” . For details please refer to the chapter ‘Advanced Option Settings’ .
- 7.To use this product with RF-602, enter into “Advanced Option Settings” , select <rF 603> and set as <rF 602> through[RIGHT]and[LEFT]buttons.
- 8.This product supports M/Multi mode. It can be switched through[MODE]button.
- 9.In off state, press and hold[MODE]button, and turn on the speedlite to enter into firmware upgrade interface.

Components Descriptions

1. Reflection board
2. Wide panel
3. Flash head
4. Micro USB port
5. External power socket
(can be connected to the SF-18C or SF-17C charging battery pack)
6. PC port (input)
7. Connector cover
8. Fixed knob
9. Hot shoe stand
10. 2.4G Wireless receive module
11. Battery cover
12. Photosensitive trigger sensors
13. Off-camera indicators
14. Sound prompt hole
15. Hot shoe contact





16. LCD Screen: Clear and visually display the functional status information.
17. Flash head zoom range button (ZOOM): Through the [ZOOM] button can set the focal length coverage (24, 28, 35, 50, 70, 80, 105mm) .
18. Trigger mode button ( / ): Operate the [ / ] button can switch between set-top /TX/RX/S1/S2.
19. Power switch (ON/OFF) : Long press the power switch for 2 second to turn on or off the power source.
20. Advanced Option Setting Button: Press[ / ]and[MODE]button at the same time to enter into 'Advanced Option Setting'.
21. Group steering Button (ACT): In TX state, press[MODE]and[ / ]button at the same time to enter group setting state.
22. Channel Setting Button (CH): In TX/RX state, press[ / ]and[ZOOM]button to enter channel setting state.
23. Set/Select Button Group: [RIGHT][LEFT][UP][DOWN]and[OK]button; through these buttons, the flash output, output fine tune, number of stroboscopic flash, flash frequency, advanced option settings, wireless communication channel (CH) and other parameters can be respectively adjusted.
24. Backlight/Sound switch button ( / ): Short press to turn on or off the LCD backlight, long press to turn on or off the sound prompt function.
25. Mode switch button (MODE): Each press the [MODE]button, the flash mode will switch between M/Multi.
26. Charge indicator/Test button(PILOT): Red lamp indicates charging is completed and flash is enabled; blue lamp indicates charging is being on, and press this button (PILOT), the speedlite will emit test flash.
27. Signal indicator: When the Speedlite receive the radio signals from the RF-602 or RF-603, the signal indicator light will light on.

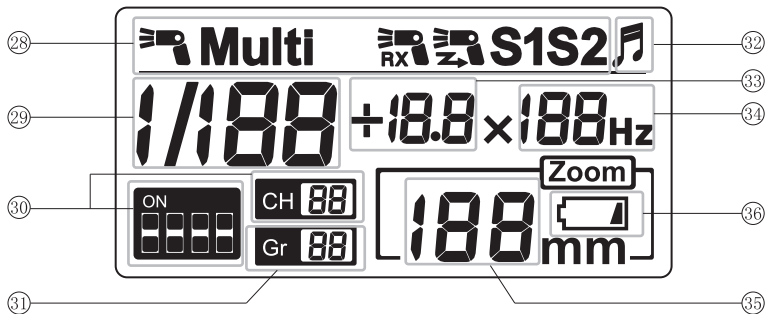

28. Flash mode/trigger mode indicator instruction

30. Channel instruction

32. Sound prompt

34. Flash frequency instruction

36. Low battery indicator

29. Output power instruction

31. Grouping instruction

33. Number of strobe flashes/output fine tuning instruction

35. Focal length instruction

Installation Instruction

1. Install Batteries

Slide the batteries compartment cover in the direction of the arrow as shown. Insert the batteries according to the label inside battery compartment and make sure the direction of the battery contact (+/-) is correct.

Close the [battery compartment cover] in the direction of the arrow as shown.

Note:Please use four standard specification AA batteries. To avoid circuit, please do not use damaged batteries.

2. Attaching to the Camera

Loosen the [Fixed knob] by rotating it in the direction of the arrow as shown.

Slip the speedlite [Hot shoe stand] into the camera hot shoe.

Turn the [fixed knob] in the direction of the arrow tighten.

To detach the speedlite, loosen the [Fixed knob] by rotating it in the opposite direction.

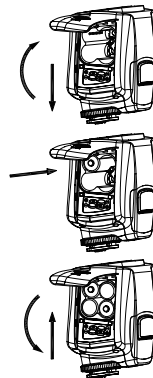

Basic Functions

1. Basic operations

Power Recycle Indicator

Status of Indicator	Meaning	Method
Red light	The speedlite is fully charged and can be used.	Normal
Blue light	The speedlite has not been fully charged.	Waiting for completion of charging.
Blue light blinking	a.Low battery; the speedlite is about to shut down. b.Overheat prompt	a.Replace batteries. b. Reduce flash frequency or stop using the speedlite until it cools down.
Red light blinking	Overheat prompt	Reduce flash frequency or stop using the speedlite until it cools down.
Red light and blue light blinking	Overheat protection mechanism is activated.	Stop using the speedlite or shut down the speedlite until it cools down.

Sound Prompt

The Sound Mode	Meaning	Method
Tick twice	The sound indicator is enabled,the speedlite is started or flash is ok.	Normal.
Tick-tick twice-tick twice	The speedlite is in the charging.	Waiting for completion of charging.
Tick-a long sound .	The speedlite is fully charged, and can be used.	Normal.
Sound in rapid succession	The power is not enough and the speedlite is going to be shut down.	Replace the batteries.
Tick-tick-tick-	The speedlite is going to be shut down.	Restart the speedlite.

2. Turn on and off the power.

Long press the [ON/OFF] button for 2 seconds to turn on or off the power source. It is suggested the batteries should be taken out after power of speedlite is turned off through this button.

After turning on the power of the speedlite, when the [charging indicator] is red, indicates the speedlite is available.

If the battery capacity is insufficient, the <charging indicator> brights with blue light. When the LCD screen displays the icon indicating the battery capacity is insufficient, the speedlite will shut down and the batteries need to be replaced.

You can press the [PILOT] button to test whether the speedlite works normally.

After use, turn off the speedlite by pressing the [ON/OFF] button for 2 seconds.

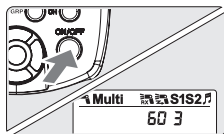

3. M Mode

In M mode, you can set flash output according to your preferences, adjust through the [Left], [Right], [Up] and [Down] button. Adjustment range of flash output is 1/128~1/1, and the flash output can be divided into 8 grades, each has maximum three grades for output fine tuning, with grade 0.3EV and 0.5EV as adjustment increment.

When shooting, you just need to set flash output, adjust the camera and press the shutter; the speedlite will flash according to the sync signal of the camera.

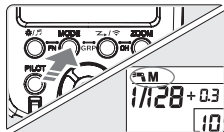

4. Multi Mode

Multi mode is strobe mode. In Multi mode, the speedlite will flash according to the output power, flash frequency and number of flashes you set. Use the [LEFT] and [RIGHT] buttons to adjust output power. The adjustment scope of output power is 1/128-1/64-1/32-1/16-1/8-1/4. To adjust the number of flashes and flash frequency, please long press the [OK] button to enter into the setting status, then short press the [OK] button to select the items (flash) to be set, use the [LEFT] and [RIGHT] buttons to adjust the number of flashes and flash frequency.

Note: In TX mode, the set top master unit flash could not set to Multi mode. The charging speed of speedlite will be slow under the situation that the electricity quantity of the battery is insufficient, which may cause the leakage of the stroboscopic flash. Please reduce the flash frequency or change new battery under this situation.

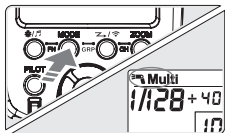



5. RX Wireless Trigger Flash

YN560 III supports receiving two kinds of 2.4GHz wireless signal: YONGNUO 602 and 603. In wireless flash shooting, YN560 III can be used as slave unit to accomplish off-camera flash.

Short press [ZOOM] button to set the trigger mode as wireless slave RX mode. Through advanced option settings, select the wireless signal as 602 or 603.

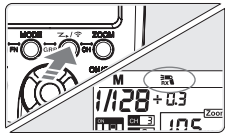
During triggering, the wireless signal of the slave unit should be consistent with the master unit.



In wireless RX triggering mode, press [] and [ZOOM] button at the meantime, the channel blinking. Press [RIGHT] or [LEFT] button to select channel, and press [OK] button to save channel settings. YN560 III has 16 channels in total for selection. In the using process, the channel of the slave unit should be consistent with the master unit, if not, triggering will fail.

When YN560 III is used as RX slave unit, it supports settings of 18 groups (A / A1 / A2 / A3 / B / B1.....F2/F3).



In RX state, press[MODE]and[]button at the same time to enter group setting state, the group blinking; press [UP] or [DOWN] button and select the groups from A to F; press [RIGHT] or [LEFT] button and select the mini-groups from 1 to 3.

In TX slave state, the relevant flash parameters can be remote controlled from the master unit, or directly modified from the current speedlite. The operation is same as the general on-camera triggering method.

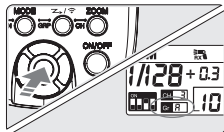
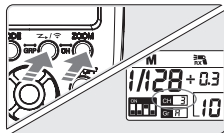
In TX slave state, the relevant flash parameters can be remote controlled from the master unit, and also can be directly modified from this using speedlite. The operation is same as the general on-camera triggering method.



6.S1/S2 Slave Mode

By pressing the [ / ] button, the flash will step into the S1/S2 mode. These two modes are suitable to be used as off-camera auxiliary light, so as to create a variety of lighting effects. They are suitable for manual flash environment and TTL flash environment respectively. Under these two modes, the way to adjust the output level is like that in M mode, which is to press the [RIGHT/LEFT] and [UP/DOWN] button. When using S1/S2 mode, you can rotate the flash head to make the wireless triggering sensor face with the master light.

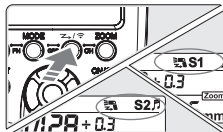

S1 mode: When the flash is in S1 mode, it will work with the first work of the master flash synchronously, with the result consistent with the use of radio slave. To use this mode correctly, the master flash should be set at manual flash and the TTL flash system with pre-flash function and the red-eye reduction function with multiple flashes should not be used.

S2 mode: It's also called 'pre-flash cancel mode'. This mode is similar with S1 mode, but it can neglect the pre-flash given by TTL flash. Therefore, it can support the main flash working in TTL mode. In particular, if S1 mode cannot flash correctly and synchronically with your internal flash, you can try to use S2 mode. The following situation shall be avoided when the S1 and S2 mode are used: the red-eye reduction function of the main light is used; the order mode (Nikon) or wireless mode (Canon) of the master is used; the ST-E2 is used as the flash controller; the stand is connected with transceiver.



7. Test Flash

Whether in any mode, you can press PILOT button to test if the speedlite flashes normally.

When testing the speedlite, the speedlite will give flash at relevant output level in accordance with the chosen output power settings.

8. Power Saving Mode

In different flash mode, YN560IV will perform a variety of power-saving mode. For example, <SE of 3 30> denotes flash-top use, it will go to sleep mode after idling for 3min, and turns off automatically after idling for 30min.

The YN560 III has three different power saving mode, S1/S2 flash power saving mode, RX radio flash power saving mode. Various power-saving modes can be set through the Advanced Options. Methods to set up: operate [ / ] + [MODE] to enter the Advanced Options setting status, select the item to be set through buttons [UP] or [DOWN], and then adjust the parameter through [LEFT] or [RIGHT] buttons.

9. Overheating Protection

If the speedlite is used too frequently, its overheating protection function will be triggered, and the speed of charging will be slower as normal. In such case, please wait for about 10 to 15 minutes to cancel the protection. To prevent the bad effect on the shooting, please try to use the 1/4 output or lower when rapid shooting is needed.

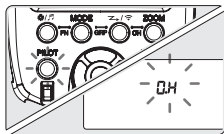

10. Manually Set the Zooming Position

By pressing [ZOOM] button, you can manually set the zooming position. The covered focal length of the speedlite will switch in circle of (24/28/35/50/70/80/105mm), and the zoom setting results will be displayed on the LCD screen.

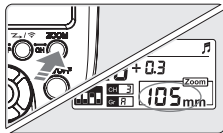

11. Sound Prompt Function

Through the C.FN06 option of custom function setting, you can turn on or off the sound prompt function. When this function is on, the speedlite will make different sounds to remind the working mode, for the specific sound method and meaning, please refer to 'Component Description' chapter.

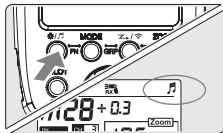

12. PC Synchronous Port (for input)

By connecting to the PC synchronous port, you can make the flash synchronously.

13. Automatic Setting Saving

The speedlite will automatically save the current settings in order to let you have a simpler use next time after boot.

14. Firmware Upgrade

This product supports firmware upgrade, please visit YONGNUO official website www.hkyongnuo.com to

download the latest update software and firmware to upgrade the speedlite. The upgrading method is as follows,

(1) Connect with the PC through USB cable (USB cable is required to buy separately)

(2) Turn off the speedlite, press [MODE], then press [ON/OFF] to turn on the speedlite and enter the upgrade interface.

(3) Enter upgrade software, upgrade the speedlite according to the software prompts.

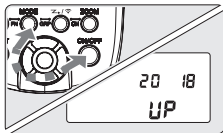

The Advanced Application

1. Multi-flash Lighting Application

YN560 III is provided with not only S1/S2 slave mode but also RX slave mode.

When using S1/S2 slave mode, built-in flash or the top external flash shall be used as the main flash; when using RX slave mode, directly trigger by using the TX master mode of YN560 IV, RF-602/RF-603 (II), and RF-605, please note that you should just set compatible [RF-602] or [RF-603] triggering method in the flash Advanced Options settings of YN560 IV, and set the channel same as the main control terminal.

S1/S2 slave mode can meet your basic lighting demand. When using S1/S2 slave mode, do not place obstacles between the main

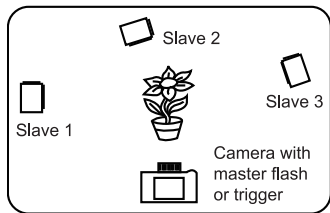

flash and the slave flash, if not, the obstacles would hinder the transmission of a wireless signal. When photosensitive triggering the flash, the maximum distance indoor is up to 25m and the maximum distance outdoor is up to 15m.

Using RX slave mode, it will effectively reduce the impact of obstacle on the radio signal, at the same time, you can get farther triggering distance and the maximum distance will be up to 100m.

2. The Use of External Charging Box

You can buy YONGNUO external charging boxes like SF-18C or SF-17C and connect it to the charging port of the flash. After flash, the charging box will charge the speedlite.

3. High-speed Continuous Shooting

The flash can realize the high-speed continuous shooting function. Please set the camera in the continuous shooting form and then shoot.



Note: The number of photos that can continuous shot is related with the output level. Please use the fully charged battery.

4. Rear-curtain Sync

You can use slow-speed shutter to produce trailing smear for the object and the speedlite will flash at the moment when the shutter is going to be shut, which means the rear-curtain sync function (the rear-curtain sync function needs the camera's own support and you can refer to the camera's user manual for its setting method).

Note: the rear-curtain function will be realized in using only when Canon camera is able to communicate with the speedlite.

5. Advanced Options Setting

YN560 III has advanced options function. You can customize speedlite function as you need, set advanced options with button group of the speedlite. Setting method of the buttons of the speedlite: press [ / ] and [MODE] button to enter into the setting state of advanced options function, select setting items by pressing [UP] and [DOWN] buttons, and, adjust parameters of each item by pressing [RIGHT] and [LEFT] buttons. The LCD screen shall show set items, for example, <SE oF 3 30> means the application at the roof, the speedlite shall automatically sleep if it is idle for 3 minutes, and automatically power off if it is idle for another 3 minutes.

Advanced options function supported by YN560 III is as following:

SL EP on: Auto power off is enabled

SL EP --: Auto power off is disabled

SE oF 3 30/15 60/30 120: Keeping idle for 3/15/30 minutes will enter the dormancy state and 30/60/120 minutes will shut down the speedlite.

SE oF -- 120: No dormancy. Shut down after keeping idle for 120 minutes.

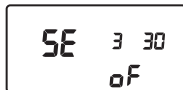

Sd 30/60/120: S1/S2 mode, auto power off cancels within 30/60/120 min



Sd 30

Sd 5 30/15 60/30 120: RX mode, keeping idle for 5/15/30 minutes the flash will enter the dormancy state and 30/60/120 minutes will shut down the speedlite.

Sd - - 120: No dormancy. Shut down after keeping idle for 120 minutes.



Sd 5 30

Lcd 7/15/30: The display time of LCD backlight is 7/15/30 seconds.



lcd 15

So nd on: Sound prompt function is enabled

So nd - -: Sound prompt function is disabled



So nd on

Inc 0.3: 0.3ev for fine-tuning step

Inc 0.5: 0.5ev for fine-tuning step

Inc 0.3 5: Mix 0.3ev and 0.5ev for fine-tuning step

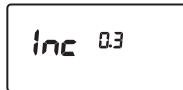
A rectangular LCD display with a black border showing the text "Inc 0.3" in a monospaced font.

qu ic - -: Quick turn on/ shut down function is disabled (Default)

qu ic on: Quick turn on/ shut down function is enabled

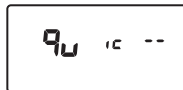
A rectangular LCD display with a black border showing the text "qu ic --" in a monospaced font.

rF 603: Compatible with RF-603 wireless transmitter

rF 602: Compatible with RF-602 wireless transmitter

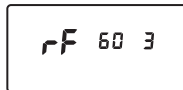
A rectangular LCD display with a black border showing the text "rF 60 3" in a monospaced font.

CL EA - -: Restore the default settings (Hold the [OK] button to restore the default settings)



VE.100: Display the information of current version for the flash

6. Reflection Flash

Bounce flash means to take photos by making flash light head aimed at wall or ceiling and using the light reflected back from the ceiling or wall to light the desired object so that the shade behind the object can be decreased to get more natural shooting effect.

If the wall or ceiling is too far, the bounce flash may be too weak to get enough exposure. The wall or ceiling should be even and white in order to get efficient reflection; if the reflection surface is not white, color cast may appear in photo.

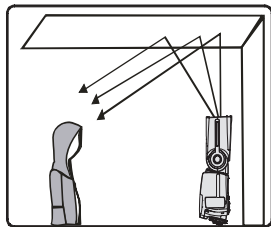

7. Use Reflection Board to Take Photos

With the reflection board flash, draw the reflection board and the wide-angle diffusion board out from the light head at the same time and then push the wide-angle diffusion board back. In such case, if this product is being used to take photos, it will produce a highlighted point on the eyes of the subject and thus make the eyes charming (catch light). This function can reach optimal effect when the flash head is up 90°.

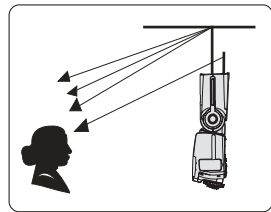

8. Use Wide-angle Diffuser

Pull out the wide-angle diffusion board, push back the reflection board and arrange them as per the figure; in such case, the flash scopes will extend and the flash effect will be softer and more natural.

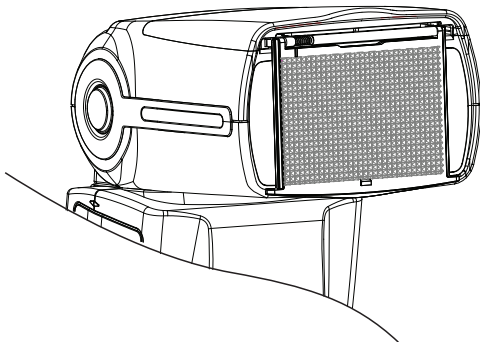

Possible problem during use and solutions

1. Please note when use the flash outdoors: For outdoor application, please avoid direct sunlight to the wireless triggering sensor and ensure normal use of the flash/
2. Precaution for outdoor use of lambency umbrella: The lambency umbrella mounted on the flash light outdoors may be blown down easily, and the hot shoe of the flash light may be broken. Please fix the mounting rack or avoid outdoor use.
3. Photos are underexposed or overexposed? Check if the set shutter, aperture and ISO are too near the flash limit or if some settings in relation to flash are proper.
4. Vignetting appears in photos or only part of the subject is illuminated? Please check the current coverage of focal length and make sure if the lens focal length exceeds the coverage range of the flash. The product's zooming range is 24~105mm of the medium format system. You can try to pull out the wide-angle diffuser to expand the flash range.
5. When used as a radio subordinate unit, it can not be triggered? Please check if the triggering signal (RF602/RF603) and the channel of the master unit are consistent with the slave unit, and check if the flash light of this speed-lite is set disabled.
6. The flash light is abnormal? Switch off the power of flash light and camera, mount the flash light on the hot shoe of camera, and switch on the power of flash light and camera again. If the abnormality continues, replace the batteries.

Specifications

Circuit design	Insulated Gate Bipolar Transistor (IGBT)
Guide No.	58(ISO 100, 105mm)
Flash mode	M, Multi
Triggering mode	Camera set-up, TX, RX, S1, S2
Zoom range	24, 28, 35, 50, 70, 80, 105mm
Vertical rotation angle	-7~90 degrees
Horizontal rotation angle	0-270 degrees
Power supply	4×AA size batteries (Alkaline or Ni-MH are usable)
Lighting times	100~1500 times (AA alkaline cell used)
Recycle time	< 3s (AA alkaline cell used)
Color temperature	5600k
Flash time	1/200s~1/20000s
Flash control	8 levels of output control (1/128~1/1), 29 levels of fine tuning
External interface	hot shoe, PC port, external charging port and Micro USB port
Wireless triggering distance	20~25m indoor (Optical control), 10~15m outdoor, 100m (2.4G wireless)
Additional features	the electronic flash head zooming, sound prompt, PC sync, power saving mode, overheating protection and auto save settings
Dimensions	60×190×78mm (Extended state)
Net weight	360g
Accessories	Flash light (1), protecting bag (1), mini stand (1), manual (1) and manufacturer certificate(1)

Guide Number of different focal length range (at ISO 100, in meters/feet)

Flash Output	Flash Coverage (mm)							
	14mm	24mm	28mm	35mm	50mm	70mm	80mm	105mm
1/1	15/49.2	28/91.9	30/98.4	39/127.9	42/137.8	50/164	53/173.9	58/190.3
1/2	10.6/34.8	19.8/65	21.2/69.6	27.6/90.7	29.7/97.4	35.4/116.1	37.5/123	41/134.5
1/4	7.5/24.6	14/45.9	15/49.2	19.5/64	21/68.9	25/82	26.5/86.9	29/95.1
1/8	5.3/17.4	9.9/32.5	10.6/34.8	13.7/45.2	14.8/48.6	17.7/58.1	18.7/61.4	20.5/67.3
1/16	3.8/12.5	7/23	7.5/24.6	9.7/32	10.5/34.4	12.5/41	13.3/43.6	14.5/47.6
1/32	2.7/8.9	4.9/16.1	5.3/17.4	6.9/22.7	7.4/24.3	8.8/28.9	9.4/30.8	10.3/33.8
1/64	1.9/6.2	3.5/11.5	3.8/12.5	4.9/16	5.3/17.4	6.3/20.7	6.6/21.7	7.3/24
1/128	1.3/4.3	2.5/8.2	2.7/8.9	3.5/11.4	3.7/12.1	4.4/14.4	4.7/15.4	5.1/16.7

The functions of this manual are based on test conditions of our company. Further notice will not be given if the design and specifications change.

The YONGNUO logo in this manual includes the registered trademark or trademark of SHENZHEN YONGNUO PHOTOGRAPHY EQUIPMENT CO., Ltd in China or/and other countries (regions). All other trademarks are the property of this respective owners.