

38/800-F/MR
V-2

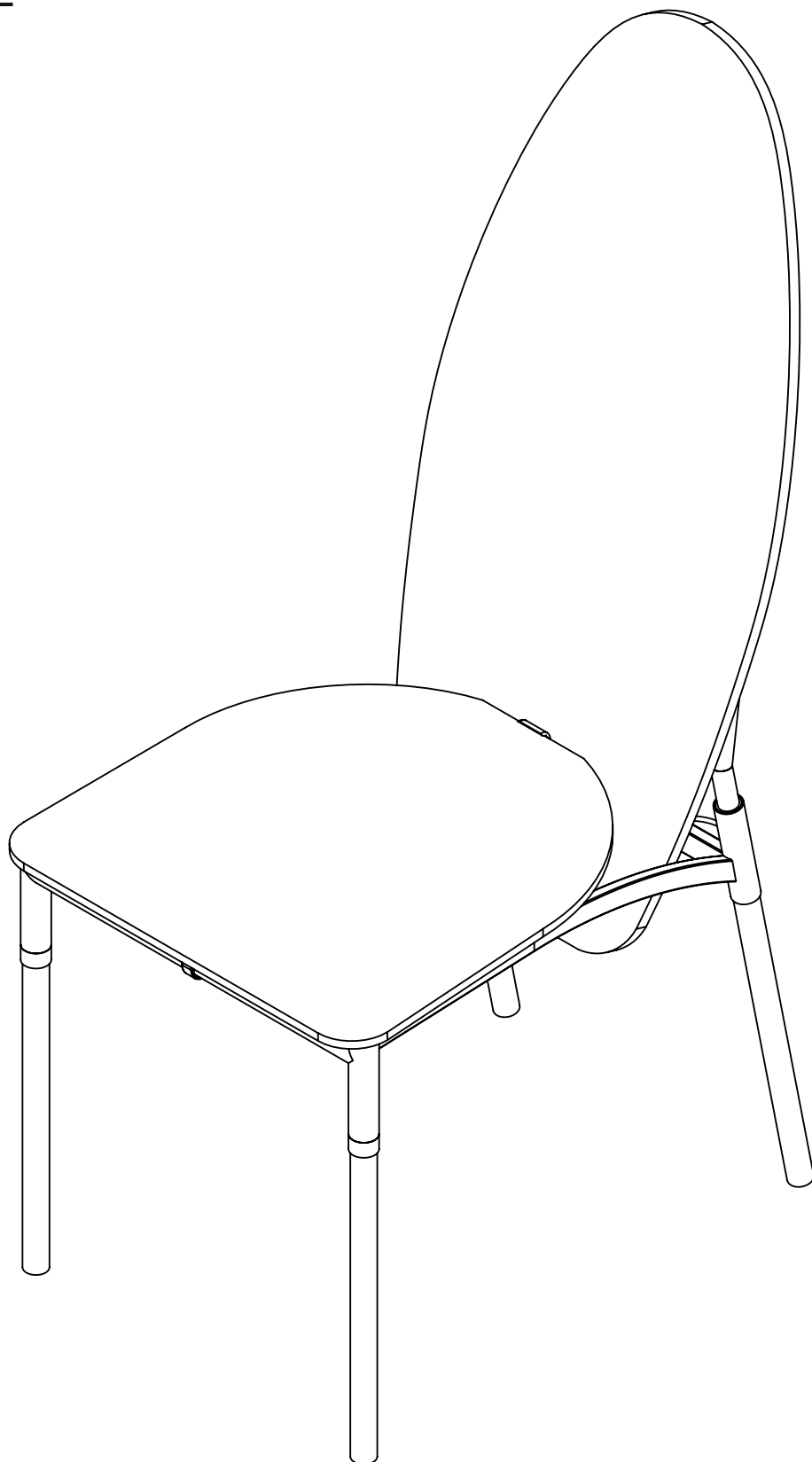

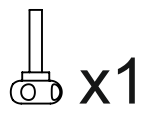

x1

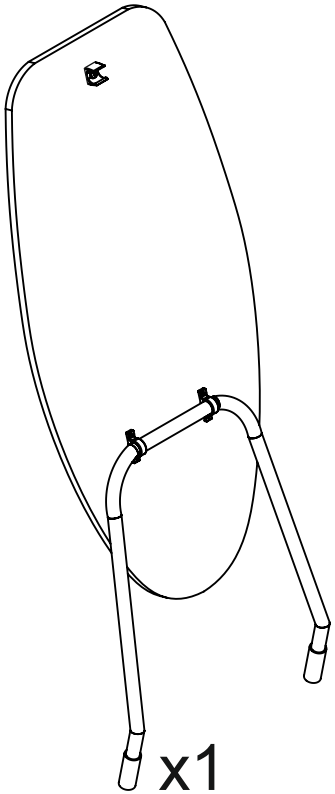
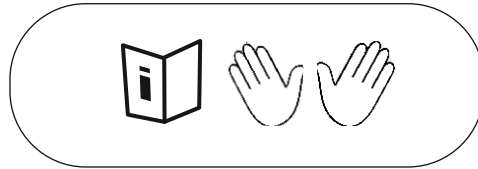
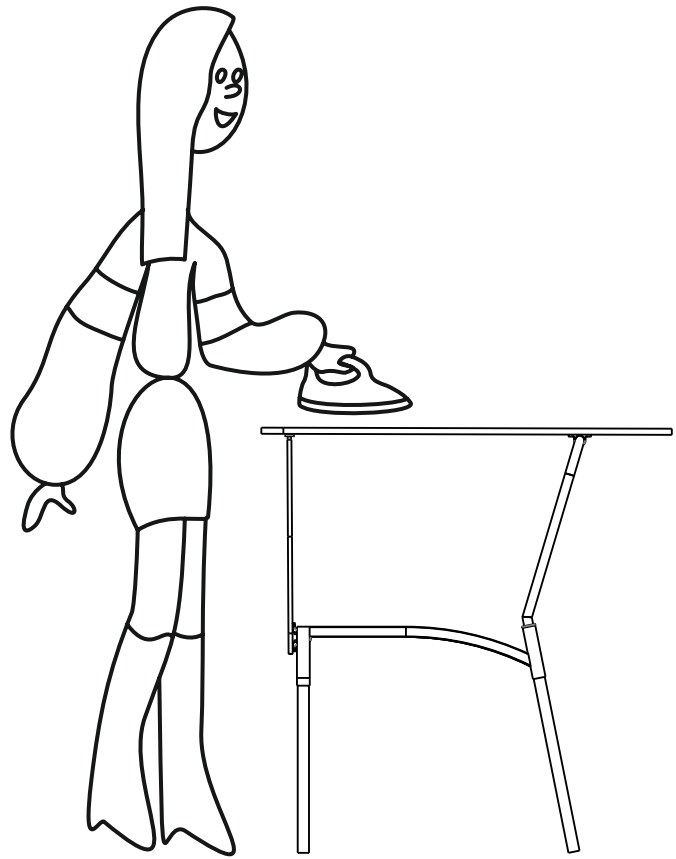
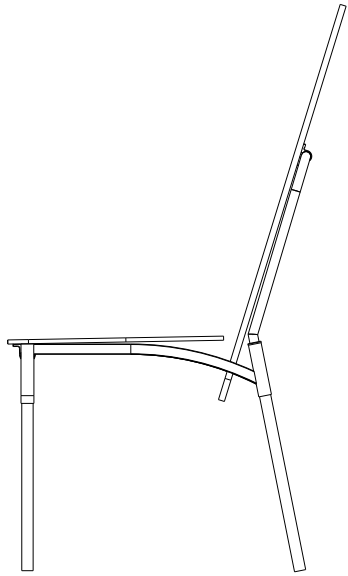
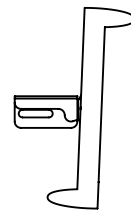
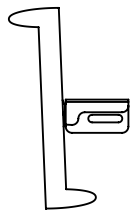

x1

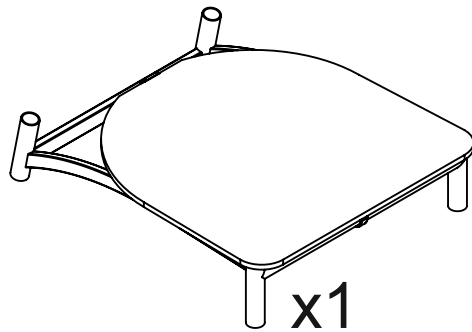

x1

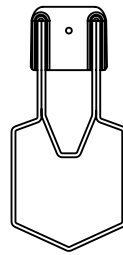

x1

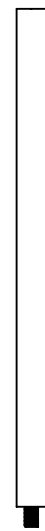

x2



x2

