

(ENG) **Top-Compartment "Antresol-1"**
 (UA) **Надбудова на шафу "Антресоль-1"**

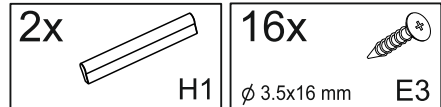
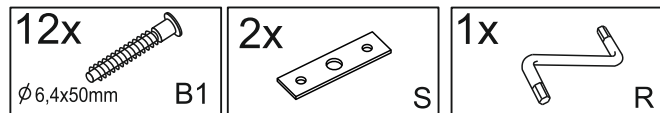
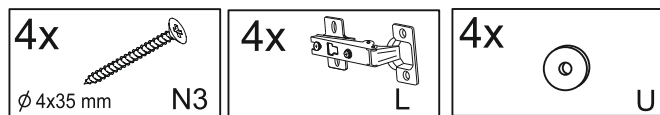
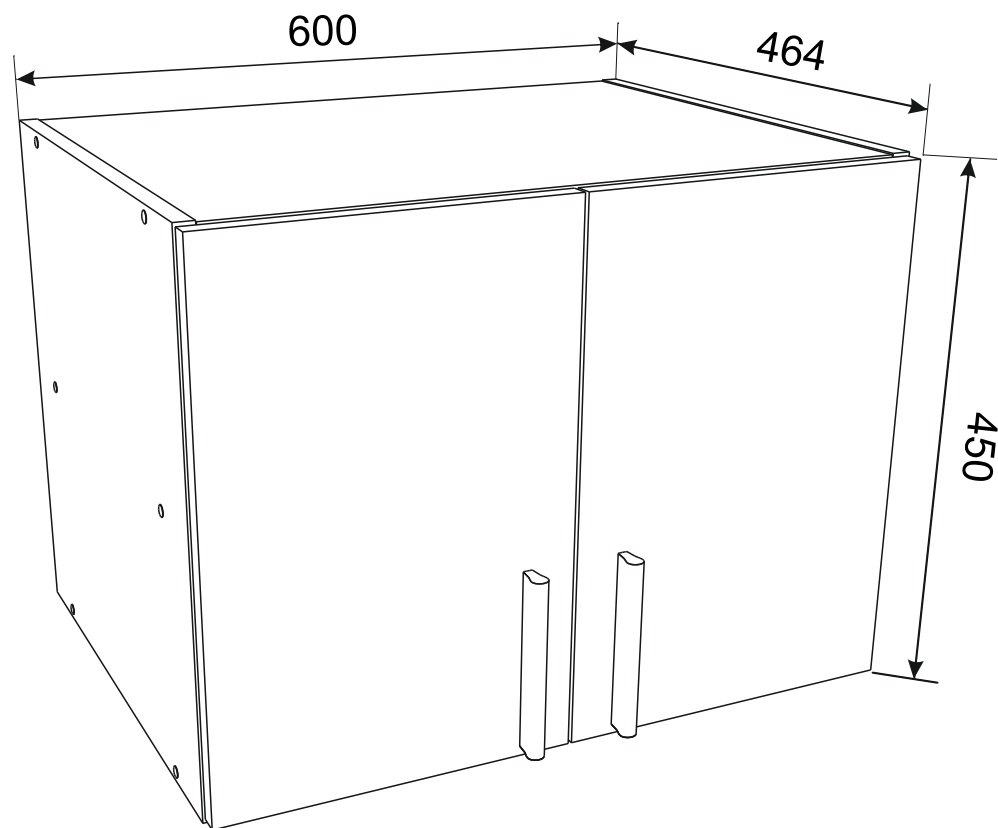

№	axb	x
1	568x448	3
2	450x448	2
3	596x222	2
4	444x297	1
5	444x297	1

Top-Compartment "Antresol-1"
Надбудова на шафу "Антресоль-1"

1

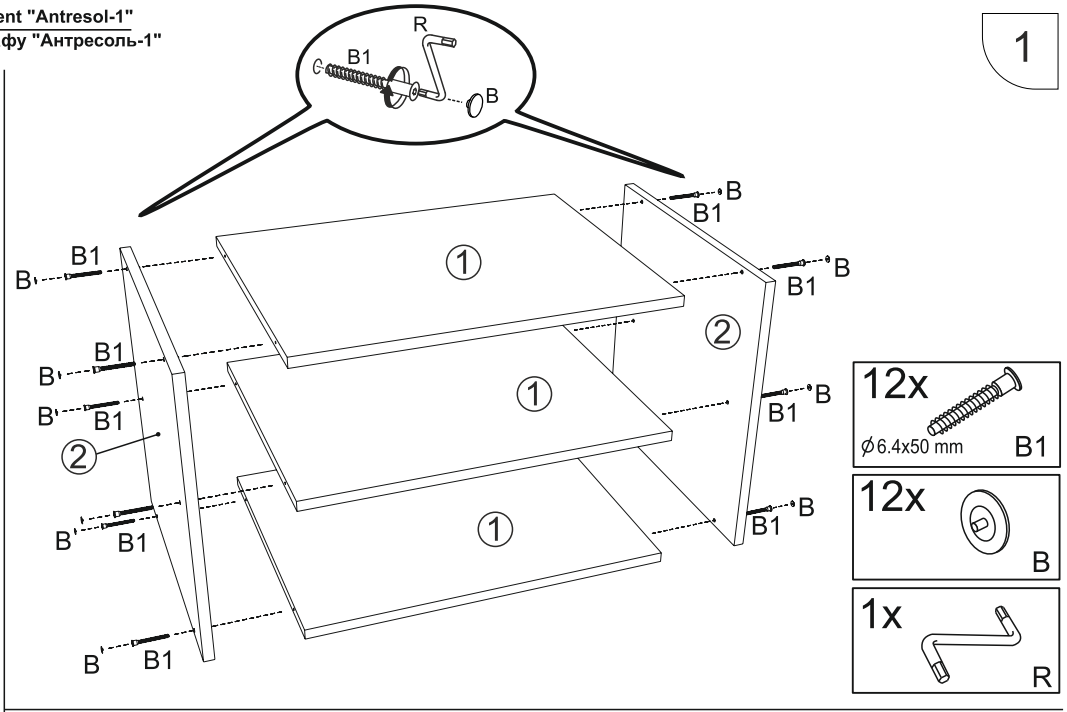
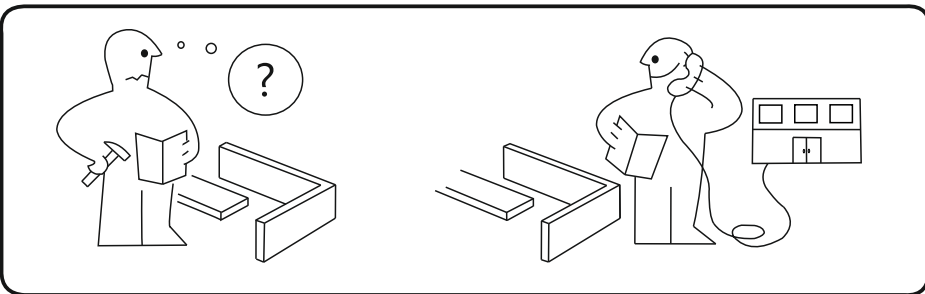
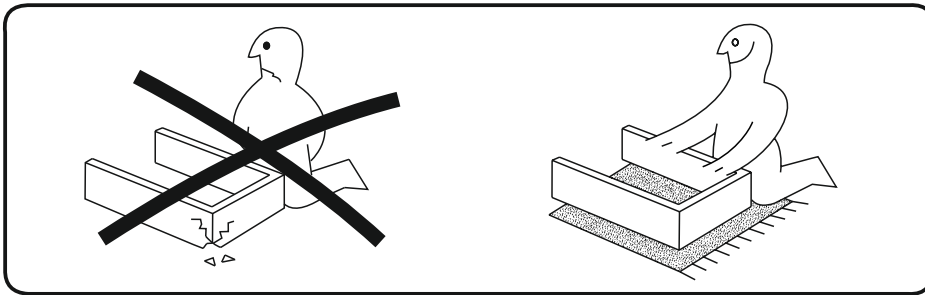
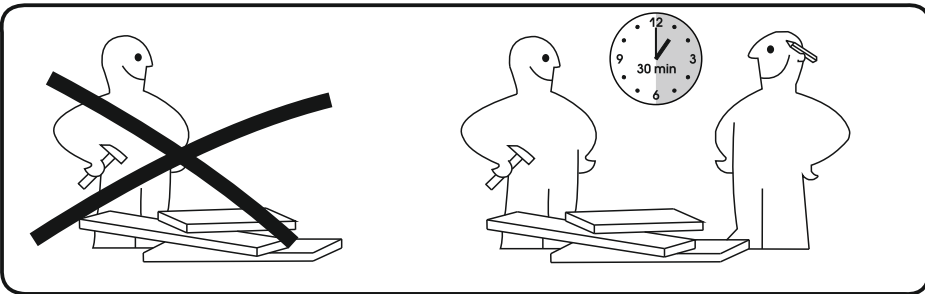
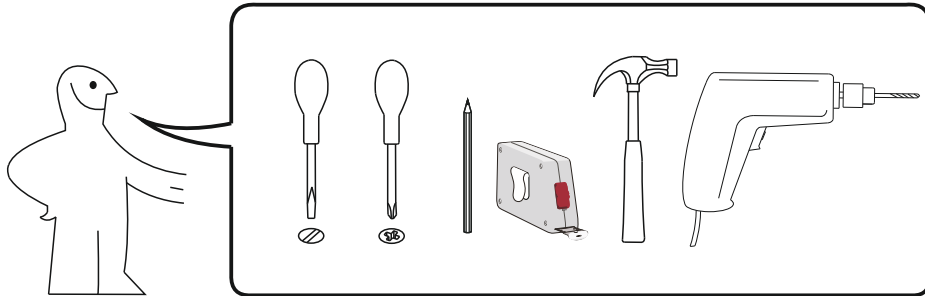

2

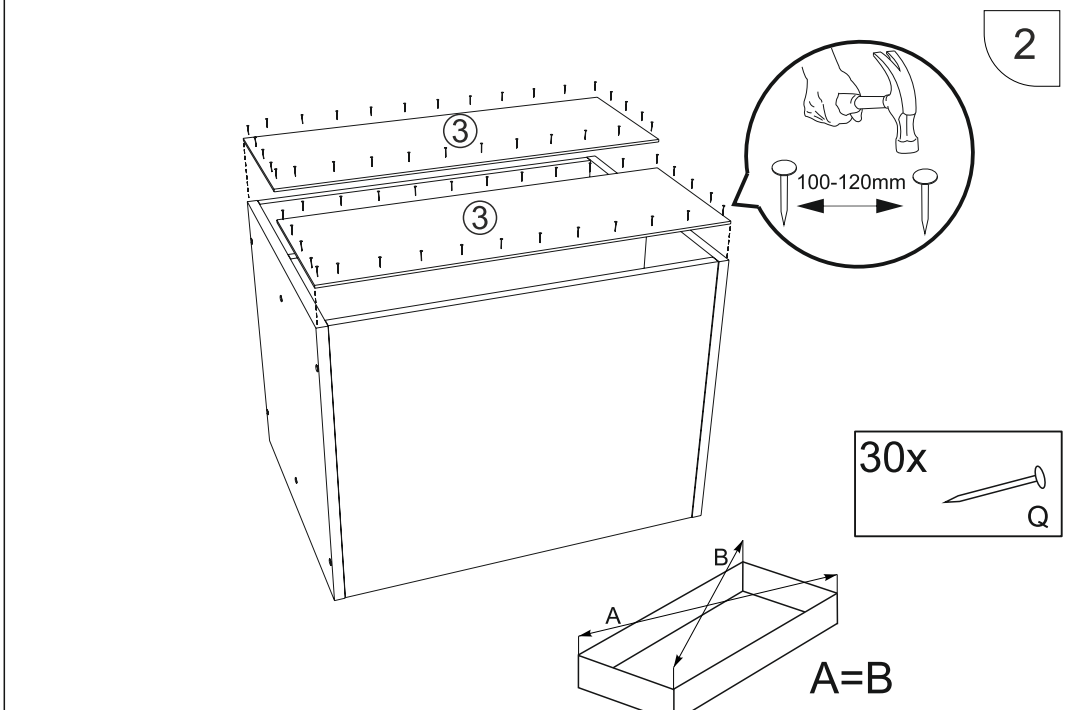

2

3

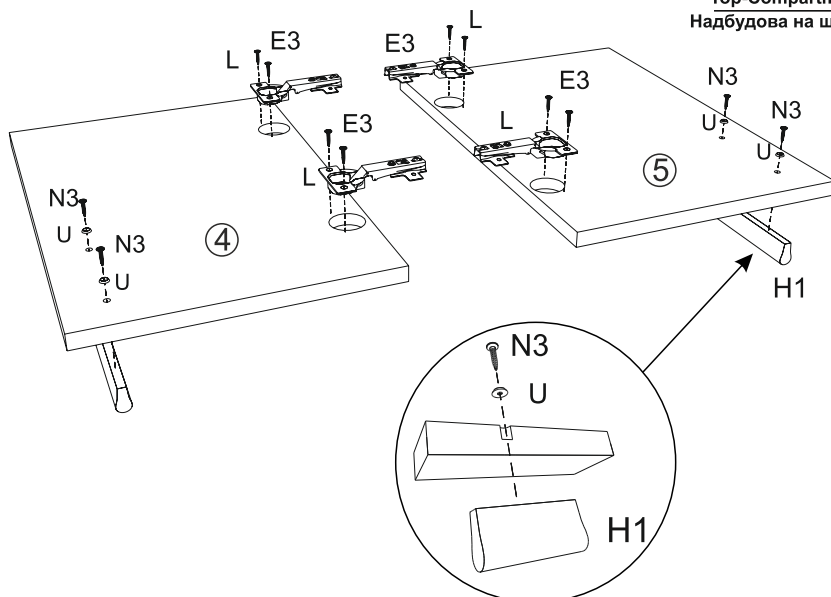
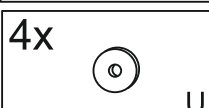
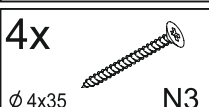
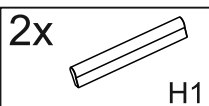
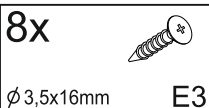
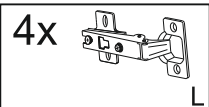

Top-Compartment "Antresol-1"
Надбудова на шафу "Антресоль-1"

4

