

# LED

## DIGITAL READOUTS

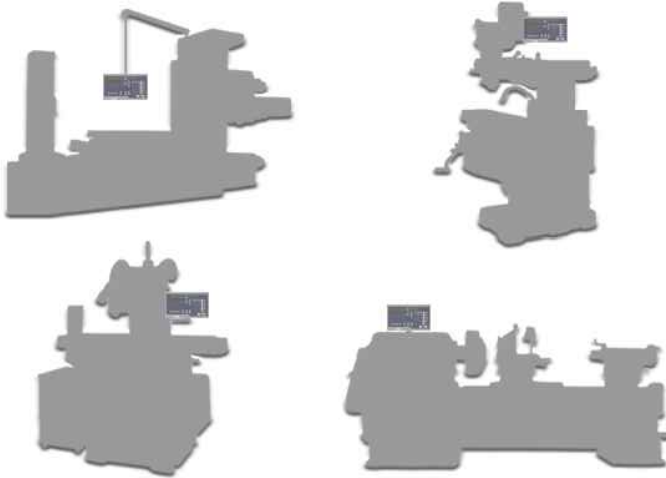

*Driven by Innovation*

**Operation Manual**  
(Version 2.0)

# A20-3V Keypad

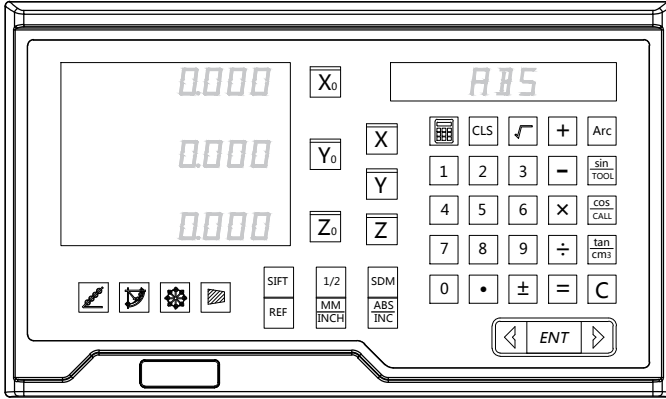

# A20-2V Keypad

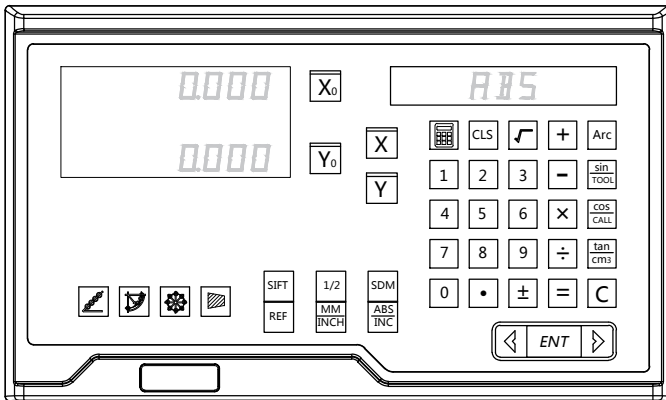

## Keypad Indication

**X** **Y** **Z** \_\_\_\_\_ Axis Selection Key

**0** **1** **2** **3** **4** \_\_\_\_\_  
**5** **6** **7** **8** **9** \_\_\_\_\_ Numeric Key

**+** **-** **×** **÷** \_\_\_\_\_ Calculation Key(Calculator Function)

 \_\_\_\_\_ Calculation Key(Calculator Function)

**C** \_\_\_\_\_ Back Key

**Arc** \_\_\_\_\_ Trigonometric function key(Calculator Function)

 \_\_\_\_\_ Square Root Calculation Key(Calculator Function)

**●** \_\_\_\_\_ Decimal Point Key

**±** \_\_\_\_\_ Minus Input Key

**ENT** \_\_\_\_\_ Confirm Key

**CLS** \_\_\_\_\_ Zero Key(Calculator Function)

**1/2** \_\_\_\_\_ 1/2 Value Key

**MM**  
**INCH** \_\_\_\_\_ Metric and Imperial Conversion Key



REF function Key



200 groups of SDM Auxiliary coordinates Key



Arc Machining Function Key



PCD Function Key



PLD Function Key



Sin Function/200 sets of Tool offset Key



Cos Function/200 sets of Tool Offset Key



Tan Function Key



Absolute and Incremental Coordinate Conversion Key

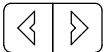

Switching Key



Taper Measuring Key

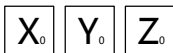

Axis Value Zeroing/Recovery Key



Digital Filtering/EDM key

# Content

1. A20 Introduction	
1.1 A20-2V(2 axis) Introduction	1
1.2 A20-3V(3 axis) Introduction	2
2. Parameter Setting	
2.1 Encoder Type Selection	3
2.2 Resolution Setting	3
2.3 Counting Direction Setting	4
2.4 Compensation Type setting (Linear or Non-linear)	5
2.5 Decimal Setting	5
2.6 Number of Axis Setting	6
2.7 DRO Mode Setting	6
3. Basic Function	
3.1 Value Zero/Value Recovery	7
3.2 Metric and Imperial Conversion	7
3.3 Coordinate Input	8
3.4 1/2 Function	8
3.5 Absolute and Incremental Coordinate Conversion	9
3.6 Full clear of 200 groups of SDM Auxiliary Coordinate	9
3.7 Power-off Memory Function	9
3.8 Sleep Function	10
3.9 REF Function	10

3.10	Linear Compensation	12
3.11	Non-Linear Function	14
3.12	200 groups of SDM Auxiliary Coordinate	17
4.	Special Function	
4.1	PLD Function	21
4.2	PCD Function	25
4.3	Smooth R Function	27
4.4	Simple R Function	30
4.5	Calculator Function	33
4.6	Digital Filtering Function	34
4.7	Diameter and Radius Conversion	34
4.8	Axis Summing Function	35
4.9	200 sets of Tool Offsets	35
4.10	Taper Measuring Function	37
4.11	EDM Function	38
5.	Appendix	
5.1	Parameter	44
5.2	Dimension	45
5.3	Troubleshooting	46

# 1. A20 Introduction

The power switch locates on the backside of the DRO. When Switched on, the DRO will enter the self-checking. After self-checking completed, the window at the left side will display the resolution for each axis. The window at the right side will display the machine mode. Mill applies to milling machine. Lathe applies to lathe machine. Grind applies to Grinding machine. EDM applies to EDM machine.

1.1 A20-2V(2 axis):Applies to 2 axis milling/Lathe/Grinding machine.

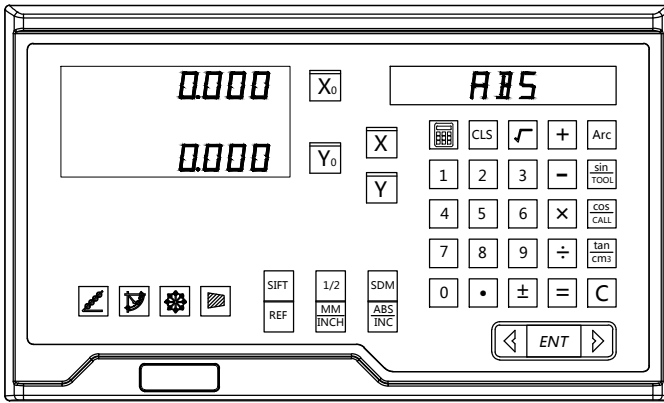

Basic Function :

1. Value Zero
2. Value Recovery
3. Metric and Imperial Conversion
4. Value Input
5. ABS/INC Coordinate System Conversion
6. Power-off Memory
7. Sleep Function
8. Calculator Function
9. REF Function
10. Linear Compensation
11. Non-Linear Compensation
12. 200 groups of SDM Auxiliary Coordinate
13. Parameter Setting
14. 1/2 Function

Special Function for Milling Machine:



Dividing hole on oblique line(PLD)



Dividing hole on circle(PCD)



Arc machining



Digital Filtering

Special Function for Lathe:



Radius and Diameter Conversion



Digital Filtering



Taper Measuring

Special Function for Grinding Machine:



Digital Filtering



1.2 A20-3V(3 axis):Applies to 3 axis milling/Lathe/EDM machine.

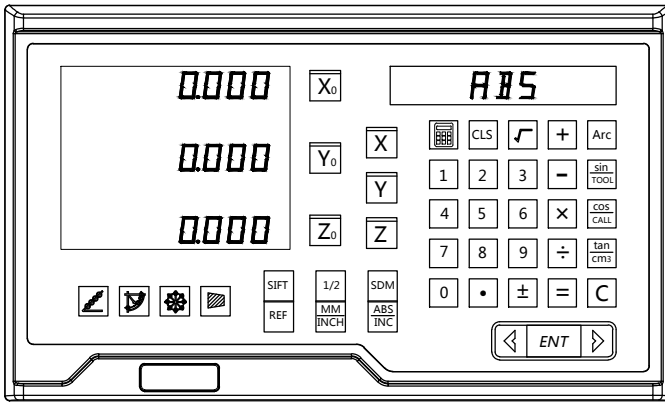

Basic Function :

1. Value Zero
2. Value Recovery
3. Metric and Imperial Conversion
4. Value Input
5. ABS/INC Coordinate System Conversion
6. Power-off Memory
7. Sleep Function
8. Calculator Function
9. REF Function
10. Linear Compensation
11. Non-Linear Compensation
12. 200 groups of SDM Auxiliary Coordinate
13. Parameter Setting
14. 1/2 Function

Special Function for Milling Machine:



Dividing hole on oblique line(PLD)



Dividing hole on circle(PCD)



Arc machining



Digital Filtering

Special Function for Lathe:



Radius and Diameter Conversion



Digital Filtering



Taper Measuring



Axis Summing

Special Function for Grinding Machine:



Digital Filtering

## 2. System Parameter Setting

The DRO will enter self-checking process when the power is switched on. This self-checking process is to check the displaying of LED, resolution and machine mode. Once the process completed, the DRO will enter working status.

While DRO is under self-checking process, press  to enter the parameter setting. The setting includes the following:

1. Encoder type Setting (Linear or Rotary)
2. Resolution
3. Counting Direction (0 indicates positive, 1 indicates negative)
4. Compensation Type (Linear or Non-Linear)
5. Imperial Decimal Setting
6. Number of axis setting
7. Machine mode

## 2.1 Encoder Type Setting

(LINER indicates linear encoder.Rotary indicates rotary encoder)

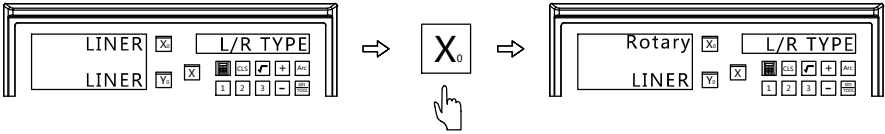

Press **X<sub>0</sub>** **Y<sub>0</sub>** **Z<sub>0</sub>** to change the encoder type.

Press to enter the next parameter setting, or press to save and exit.

## 2.2 Resolution Setting

(Set the resolution for the corresponding encoder)

(1) The fixed resolution of linear encoder includes:

0.1um,0.2um,0.5um,1um,2um,2.5um,5um,10um,20um,50um.

Press **X<sub>0</sub>** **Y<sub>0</sub>** **Z<sub>0</sub>** to change the resolution for each axis.

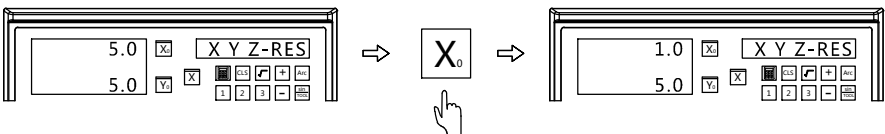

(2) For setting the resolution of rotary encoder, we need to input the corresponding resolution(ppr). There are two ways for displaying. When the positive number has been input, the displaying will be as degree. When the minus number has been input, the displaying will be as degree/minutes/seconds.

Example: The resolution of rotary encoder is 2000ppr.

Set the encoder type be rotary.

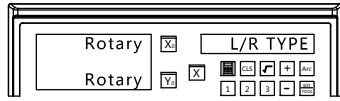
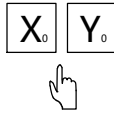

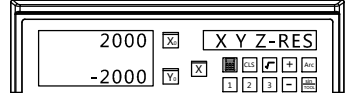
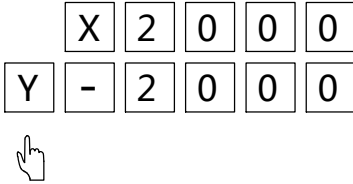

Input 2000 as the resolution of X axis. Input -2000 as the resolution of Y axis.

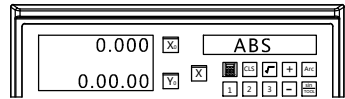

The counting of X axis is displaying as degree. The counting of Y axis is displaying as degree /minute/second.





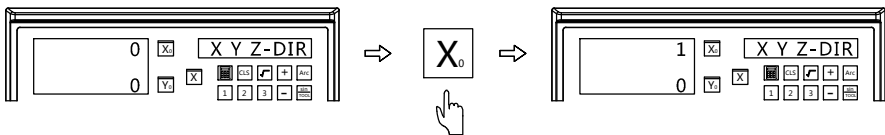

Press  to enter the next parameter setting, or press  to save and exit.

## 2.3 Counting Direction Setting

The counting direction can be reversed in this DRO. When the left axis window displaying 0, it indicates this axis counts as positive direction. When the left axis window displaying 1, it indicates this axis counts as negative direction. The operations are shown as below:



Press    to change the counting direction of X, Y, Z axis.

Press  to enter the next parameter setting, or press  to save and exit.

## 2.4 Compensation type setting (Linear or Non-Linear)

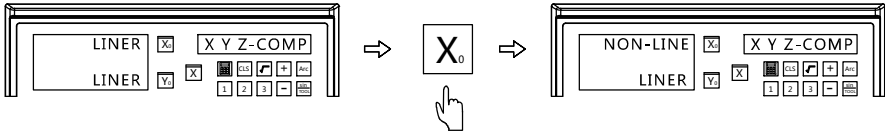

When entering the compensation type setting, LINER displayed on left axis window indicates linear compensation for this axis. NON-LINER indicates non-linear compensation type. The operations are shown as below:



**LINER:** Selecting linear compensation type (For detail setting, please refer the linear compensation instruction)

**NON-LINER:** Selecting non-linear compensation type (For detail compensation setting, please refer the non-linear compensation instruction)



Press **X<sub>0</sub>** **Y<sub>0</sub>** **Z<sub>0</sub>** to change the compensation type of X, Y, Z axis.

Press  to enter the next parameter setting, or press  to save and exit.

## 2.5 Imperial Decimal Setting

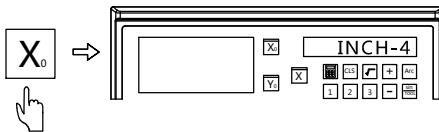
There is option to display 4 or 5 digits after decimal point under imperial model. User could set according to using habit. The operations are shown as below:





Press  to enter the next parameter setting, or press  to save and exit.

## 2.6 Number of Axis Setting

The number of displaying axis could be set in this DRO. For example, if the DRO gets 3 axis displaying. We could turn off 1 or 2 axis of the three to make it be 1 or 2 axis displaying.

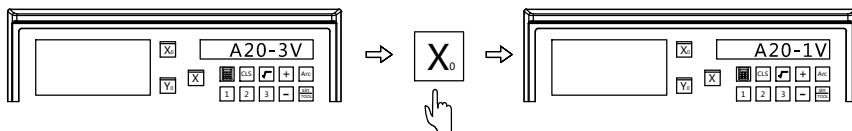
Once entered the number of axis setting, press  $X_0$  to set the number of axis. The operations are shown as below:



Press  to enter the next parameter setting, or press  to save and exit.

## 2.7 Machine Mode Setting

While entered the machine mode setting, press  $X_0$  to select the machine mode. Both A20-1V and A20-2V contain mode of MILL, LATHE and GRIND. A20-3V contains the mode of MILL, LATHE and EDM. User could select accordingly.

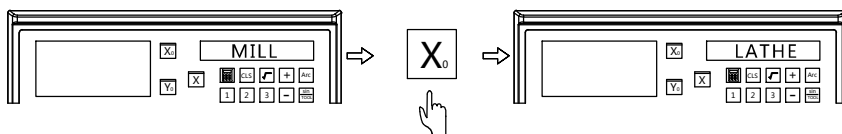

MILL indicates the current mode.

LATHE indicates the set mode.

Press  to save and exit.

## 3. Basic Function

1. Value Zero/Value Recovery
2. Imperial and Metric Conversion
3. Value Input
4. 1/2 Function
5. ABS/INC Coordinate System Conversion
6. Full Clear of 200 Groups of SDM Auxiliary Coordinates
7. Power-off Memory
8. Sleep Function
9. REF Function
10. Linear Compensation
11. Non-linear Compensation
12. 200 Groups of SDM Auxiliary Coordinates

### 3.1 Value Zeroing/Value Recovery

(1) Value Zeroing(User could zero the displayed value at any coordinate)

Example:Zero the displayed value of X axis at current position.

(Same operation to Y and Z axis)

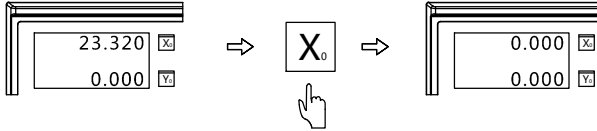

(2) Value Recovery(User could recover the value which has been zeroed by wrong operation)

Example:Recover the value of X axis.(Same operation to Y and Z axis)

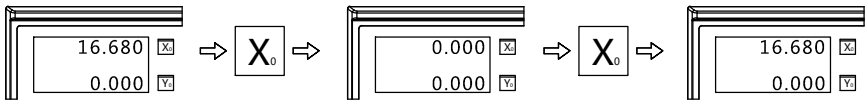

### 3.2 Imperial and Metric Conversion

( Switch the displaying unit under imperial or metric model.)

Example 1: Switch the current imperial unit(inch) to be metric unit(mm)

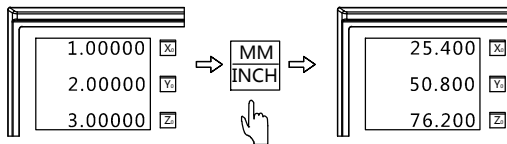

Example 2: Switch the current metric unit(mm) displaying to be imperial unit(inch).

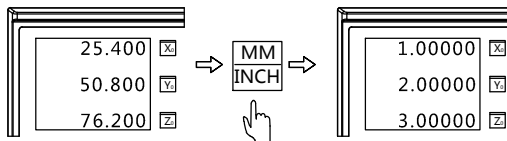



### 3.3 Value Input

(User could set the current position to be any value)

Example: Set the current position of X axis to be 12.4.

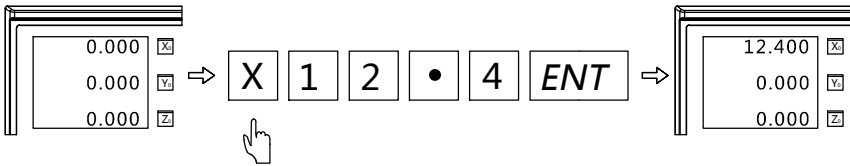

### 3.4 1/2 Function

(The DRO gets the automatic centre find function. It could divide the current displayed position value by two. Thus user could set the zero point at the centre of work-piece)

Example: Set the zero point of X axis at the centre of work-piece. (Same operation to Y axis)

Step 1: Align the edge finder on one side of work-piece for X axis, then zero the value.

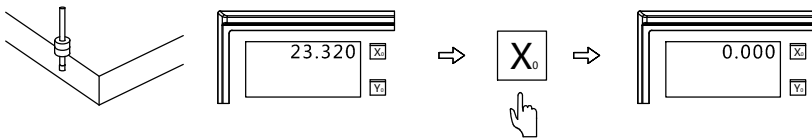

Step 2: Align the edge finder on the other side of work-piece for X axis. Press **X**, and press **1/2** to divide the value by two for X axis.

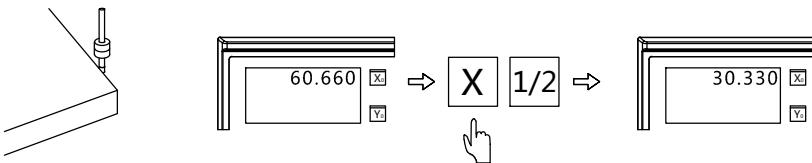

Step 3: Move the table of X axis until the value of X axis to be 0.000. The current position is the centre of work-piece for X axis.

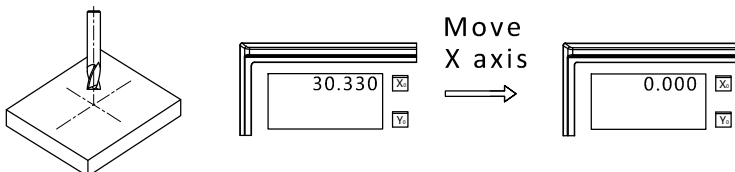

### 3.5 ABS/INC Coordinate System Conversion

The DRO gets two sets of standard coordinate system, namely ABS(Absolute) and INC (Relative) Coordinate. User could set the zero point of work-piece in ABS coordinate, then switch to INC coordinate for machining. Zeroing at any position in INC coordinate would not affect the length value from zero point to current point in ABS coordinate. The process in ABS would change according to the machining status. User could switch the coordinate back to ABS for checking.

Example 1: Press  to change the current ABS coordinate to be INC coordinate.

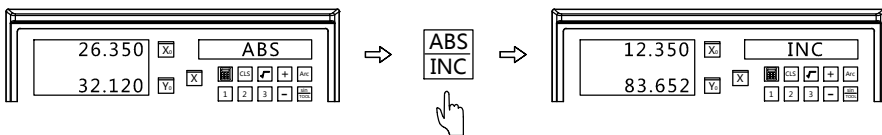

Example 2: Press  to change the current INC coordinate to be ABS coordinate.

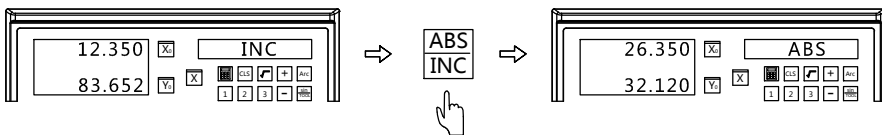

### 3.6 Full Clear of 200 groups of SDM Auxiliary Coordinate

When the DRO is under ABS mode, press  10 times. The left window will display CLR SDM. At this time, the 200 groups of auxiliary coordinate has been full cleared.

### 3.7 Power-off Memory

In case of sudden power off during the machining process, the DRO gets the data memorize function. Once the power on, the date before power off will recover automatically.

### 3.8 Sleep Function

When meet the occasion that the operator would leave for rest,the DRO could be set as sleep state.To enter the sleep state,the DRO should not be in ABS model.

Example:Press REF to enter the sleep state,make sure the DRO is not in ABS model.

To activate the DRO,press REF to get back previous machining interface.

### 3.9 REF Function

In daily machining,we may encounter power failure.If losing the zero point of the work-piece,we have to retrieve the zero point again.For the convenience to retrieve the zero point,the DRO could memorize the mechanical zero reference point of linear scale.This enable the users to retrieve the zero point of work-piece quickly.

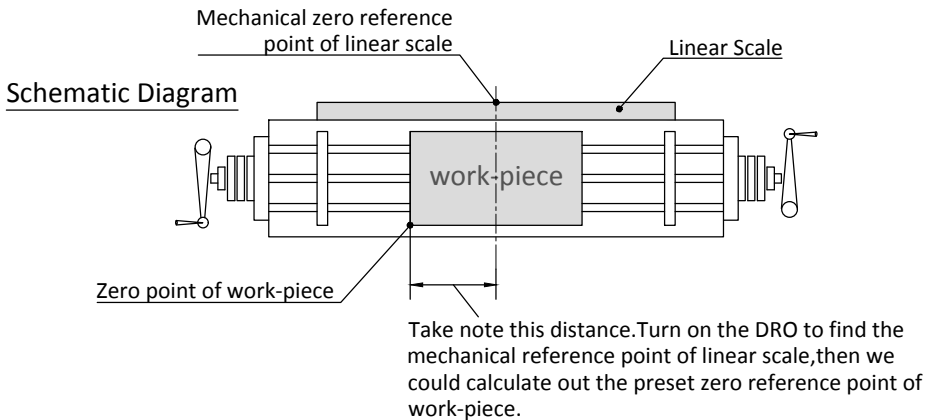

#### (1) Set the mechanical zero reference point of linear scale

Note:To use the REF function,we need to set the mechanical zero reference point of linear scale in DRO.In this way,the DRO could memorize the zero point of work-piece.For the following zeroing,centre and value input for re-locate the zero point of work-piece under ABS model,the DRO will memorize the distance between new zero point of work-piece and mechanical zero reference point of linear scale.The operations are shown as below:

Step 1: Enter the REF function,select REF to set the mechanical zero reference point of linear scale.

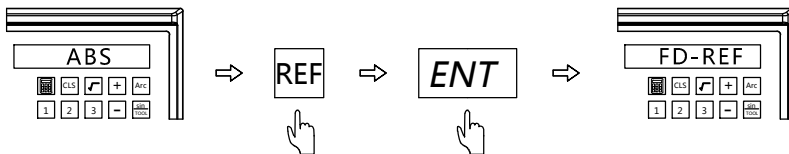

Step 2: Select the axis which shall be set.(Take X axis as example,same operation to Y and Z axis)

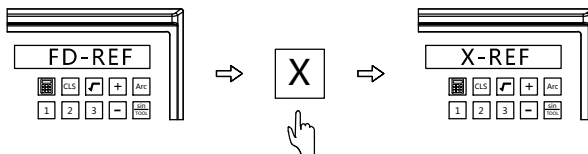

Step 3: Move the table,the DRO will search the mechanical zero reference point of linear scale automatically.Once the reference point has been found,the buzzer would ring once.The right window will display FIND-X(The right window will display FD-REF again in 2 seconds,at this time,user could Press Y or Z again to find their reference point when it is necessary.)

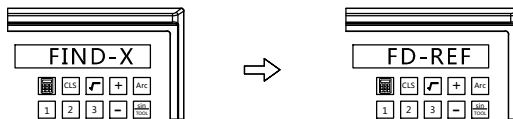

Step 4: Press REF to exit REF function and back to machining interface.

## (2) Retrieve zero point of work-piece

Note:Once the mechanical zero reference point of linear scale has been set,we could retrieve the zero point of work-piece quickly if we lose it.Operations are shown as below:

Step 1: Take note of X,Y and Z axis under ABS model once the DRO self-checking process completed.

Step 2: Enter REF function,select retrieve zero point of work-piece(same operation to Y and Z axis)

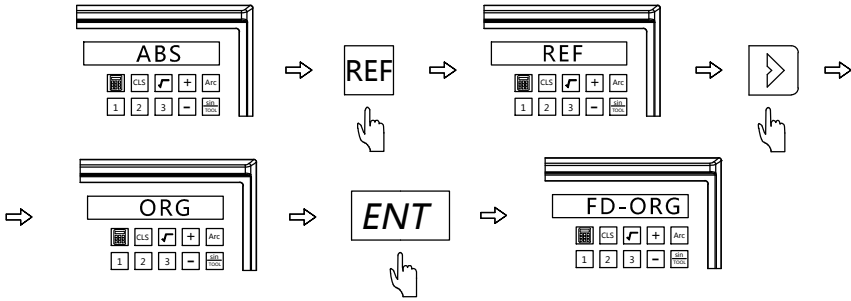

Step 3: Move the table for X axis, the DRO will search the mechanical zero reference point of linear scale automatically. Once the reference point has been found, the buzzer will ring once. The right window will display FIND-X. (the right window will display FD-ORG in 2 seconds)

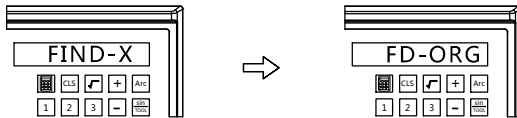

Step 4: Once the mechanical zero reference point has been found for X, Y and Z axis, at this time, the zero point of work-piece locates at (0,0,0). The move the table until the value of each axis to be the one we took the note. At this time, this point is the one we stopped for last machining.

Step 5: Press **REF** to exit the REF function and back to machining model.

### 3.10 Linear Compensation

This function is to correct the system error of linear scale. Zero the value of the axis which shall be compensated. Move the table of this axis, then use other more accurate measuring instruments to measure the actual moving length. Once get the actual moving length, then enter the linear compensation to input the actual moving length value. At this time the error will be corrected.

Example: Taking 1000mm as example. (Same operations to Y and Z axis)

Step 1: Press **X<sub>0</sub>** to zero, Move the table until the DRO display 1000mm. We measured the actual moving length is 999.980

Step 2 : Press **X** **MM/INCH** to enter the linear compensation for X axis.

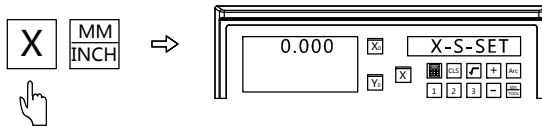

Step 3: Press **X<sub>0</sub>**, then input the actual moving length value, press **ENT**. The DRO will calculate the compensate value automatically. If the input value is correct, the DRO will exit automatically. If the input value is wrong, the right window will display X-ERR to alarm.

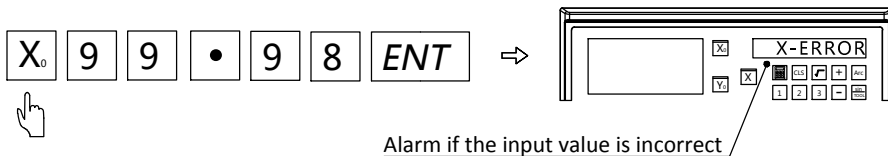
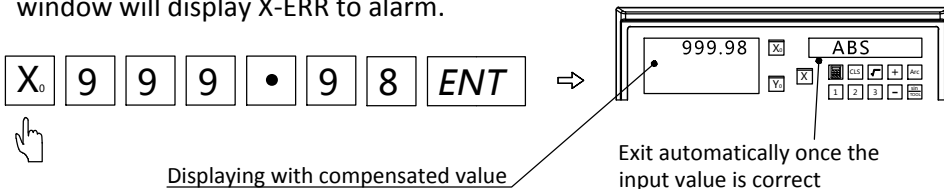

Note: User could calculate the compensated value by the below formula. Then input the compensated value. (operation step 1 and 2 are same as above) After inputting the compensated value, press **ENT** to exit linear compensation. Operations are shown as below:

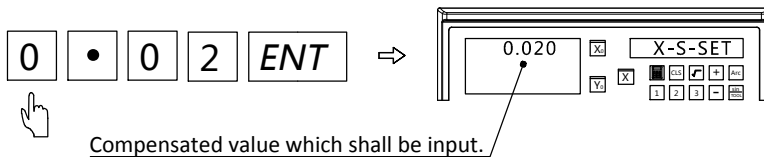

Formula for compensated value:  $S = (L - L1) / (L / 1000) \text{ mm/m}$

L: The actual measured length(mm)

L1: Displayed value(mm) on the DRO

S: Compensated value(mm/m)

(+ indicates lengthening, and - indicates shortening)

Compensation range: -1.9mm/m to +1.9mm/m

### 3.11 Non-Linear Compensation

Non-linear compensation function enable users to input the non-linear error compensation value in the DRO to improve the accuracy of machining.This function is applicable to machines which have high requirement of accuracy.(Boring machine,Grinding machine...etc)

Non-linear compensation function takes the mechanical zero reference point of linear scale as the origin point of machine.The DRO will compensate the displayed value according the input err list.Each axis has a maximum 40 points for compensating.Please note Linear compensation and Non-linear compensation function could not be used at the same time.

The DRO gets two ways for non-linear compensation.

1. Take the linear scale end point as the starting point for compensation.  
(Figure 1)
2. Take the first mechanical zero reference point of linear scale as the starting point for compensation.(Figure 2)

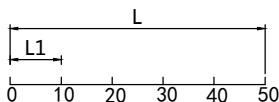

(Figure 1)

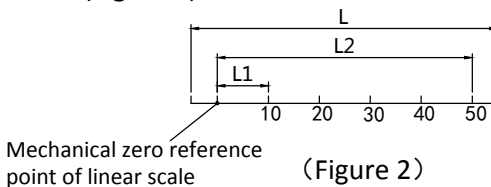

(Figure 2)

Starting point is the end point of linear scale(most right or most left)

Starting point is the mechanical zero reference point of linear scale

L: Effective measuring length of linear scale L1: Length of compensation part

L2: Effective compensation length

#### (1) Parameter setting (Take X axis as an example.Same operation to Y and Z axis)

Step 1: In DRO system parameter setting,set the compensation type to be Non-linear compensation.Press **ENT** when DRO is under self-checking process.Press **▶** to select XYZ-COMP.Press **X<sub>0</sub>** to set compensation type of X axis to be non-linear compensation.Press **●** to exit the system parameter setting.Operations are shown as below:

## Basic Function

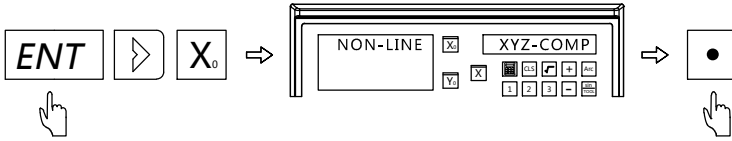

Step 2: Move the table of X axis to one of the most end and zero the value.

Make sure the coordinate is ABS model.

Step 3: Press **X** **MM**/**INCH** to enter compensation of X axis.

Input the related parameter.

Step 4: Input the number of compensation part. Press **5**, and press **ENT**

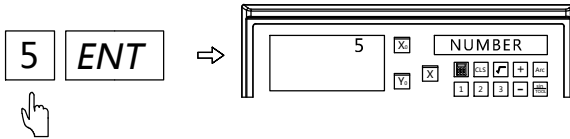

Note: The number of compensation part for each axis should be input on X axis.

Step 5: Input the length of each compensation part.

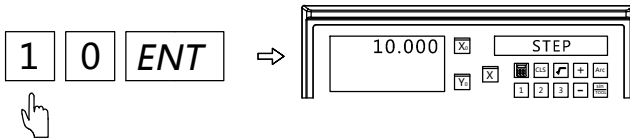

Step 6: Select the starting point (A: most end point of linear scale B: Mechanical zero reference point of linear scale)

Press **←** **→**, and press **ENT** to confirm.

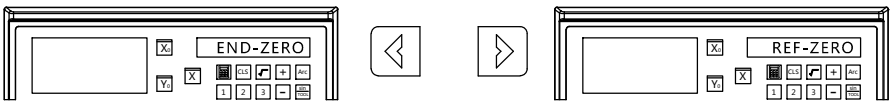

A: Most end point of linear scale

B: Mechanical zero reference point of linear scale

Step 7: Set the starting point

1. If choosing option A, move the table of X axis to the most left end or right end and zero the value. At this time, the starting point for compensation is the zero point. Press **ENT** to enter next step.



2. If choosing option B, move the table of X axis to find the mechanical zero reference point. Once the point has been found, the DRO will enter the next step automatically.

Step 8: Moving table to 10mm. (The 10mm is basing on other more accurate measuring instrument.) Press **ENT** to set the next point. (Same operations to the rest point)

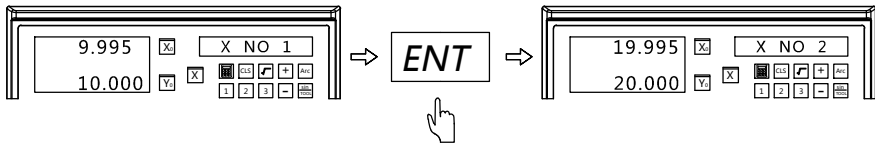

Note: X axis display the actual moving length of linear scale. While Y axis display the corrected value

For this function, the compensation value could not exceed 2mm/m.

## (2) Canceling the non-linear compensation

Same operation as above to enter the non-linear compensation. Input 0 as number of compensation part. At this time, all parameter in non-linear compensation will be cleared. The current compensation value will become 0.

Note: The compensation value will not be correct if move the DRO and linear scale who has been set the non-linear compensation value to another machine. In this case, we need cancel the compensation value or reset.



### 3.12 200 Groups of SDM Auxiliary coordinate

DRO provides ABS and INC coordinate. But sometimes it is not enough for daily machining. This DRO provides 200 groups of SDM auxiliary coordinate to compensate the shortage of ABS and INC function. But SDM is not just a simple additional INC coordinate. The below is the difference between ABS/INC and SDM.

1. INC is completely independent. No matter how zero point in ABS changed, the zero point in INC will not change. But the zero point of SDM is basing on ABS. When the zero point in ABS changed, all coordinate in SDM will change accordingly.
2. The distance between SDM and ABS coordinate could be input directly.

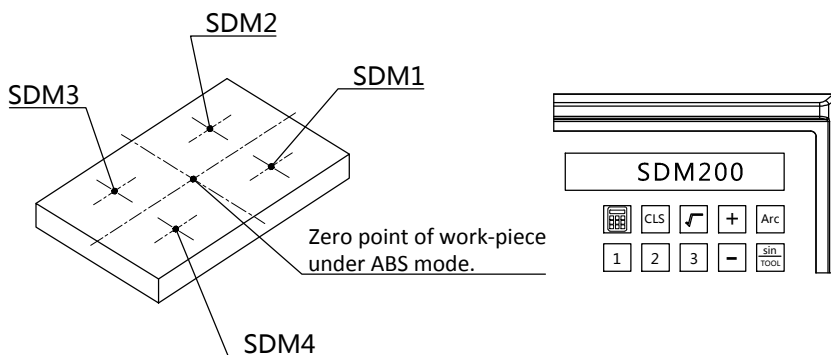
Applications for SDM coordinate:



Press  or  to switch SDM auxiliary coordinate with no need to return to ABS mode.

SDM application during medium or small batch machining

SDM function could memorize a batch of working point. User could input these working points when machining the first work-piece. Then adjust the zero point in ABS mode for machining the following work-pieces. The SDM auxiliary coordinate is basing the zero point in ABS mode.

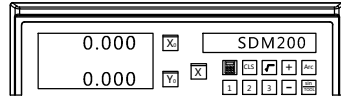
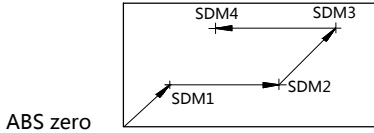

Zero point of work-piece (0.000)

Press **SDM** to input the number of machining point under SDM model. Or press **◀ ▶** to turn to machining point by turn. Move the table until the SDM coordinate value to be 0, then this is the machining point.

Example:

If setting 4 sets of auxiliary coordinate on working-piece (SDM1--SDM4), we could use the below two ways.

1. Zeroing in place
2. Input the number of SDM auxiliary coordinate

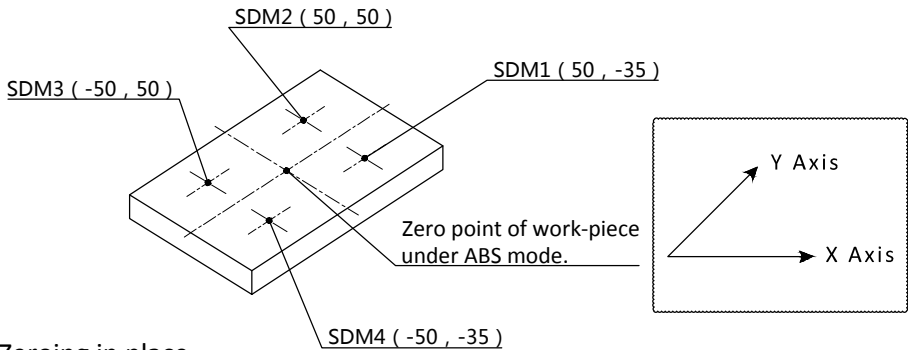

### 1. Zeroing in place

Set the zero point of work-piece in ABS mode. Move the table to each machining point, then switch the DRO to be SDM mode and zero the value of current position.

Step 1, Set the zero point of work-piece in ABS mode.

Move the table to the zero point of work-piece

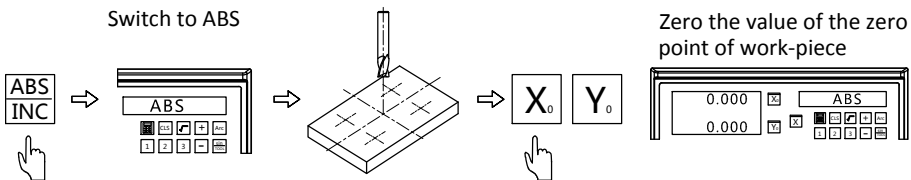

## Basic Function

Step 2, Set the first machining point.(Same operation to the following point)

Move the table to be X=50,Y=-35

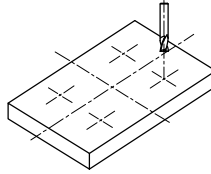
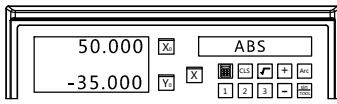

Enter SDM1

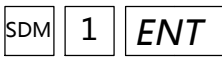

Zero



Complete the set of first point

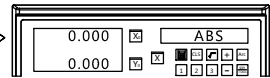

Same operation to SDM2,SDM3,SDM4

Press to check whether the SDM coordinate is correct.

(checking SDM4 coordinate value basing ABS,SDM1,SDM2,SDM3)

Enter ABS coordinate

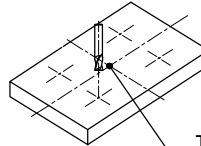
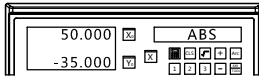

The coordinate value of SDM4 is basing ABS

Enter SDM1

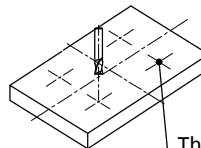
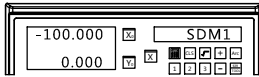

The coordinate value of SDM4 is basing SDM1

Enter SDM2

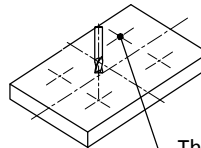
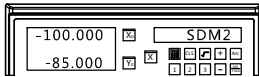

The coordinate value of SDM4 is basing SDM2

Enter SDM3

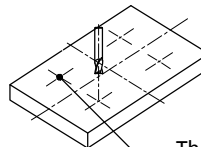
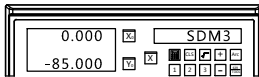

The coordinate value of SDM4 is basing SDM3

2. Input the number of SDM auxiliary coordinate

Once the zero point of work-piece has been set in ABS mode, move the table to the zero point. Then input all SDM coordinate at this point

Step 1, Set the zero point of work-piece in ABS mode.

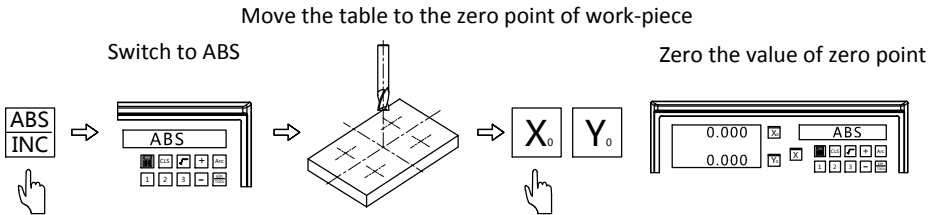

Step 2, Set the zero point of SDM

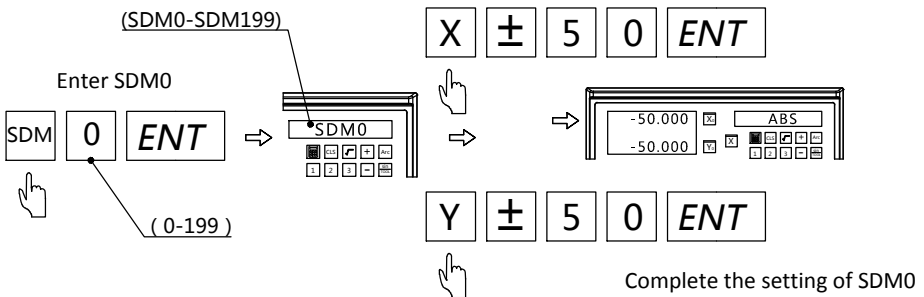

Same operation of SDM1,SDM2,SDM3.....SDM199.

Note: When input the SDM coordinate, we have to do the inversion of positive and negative. Because the SDM coordinate points on drawing are taking ABS zero point as reference. In practice they are taking SDM0 as reference. When inputting, it is parallel to take the ABS zero point by different SDM coordinate.

Note: Quick set of SDM coordinate

The DRO provides 200 sets of SDM coordinate. To set one by one is time costly. If the DRO is under ABS or INC mode, press SDM twice. Then input coordinate number to set.

## 4. Special Function

1. PLD Function
2. PCD Function
3. Smooth R Function
4. Simple R Function
5. Calculator Function
6. Digital Filtering Function
7. Diameter and Radius Conversion
8. Axis Summing Function
9. 200 sets of Tool Offsets
10. Taper Measuring Function
11. EDM Function

## 4.1 PLD Function

(Applies to 2&3axis milling machine and 3 axis EDM machine)

There are two ways for PLD function.

1. Length way(L-LEN ,the distance between the starting hole center to end hole center)
2. Step way(L-STEP,the distance between two holes center)

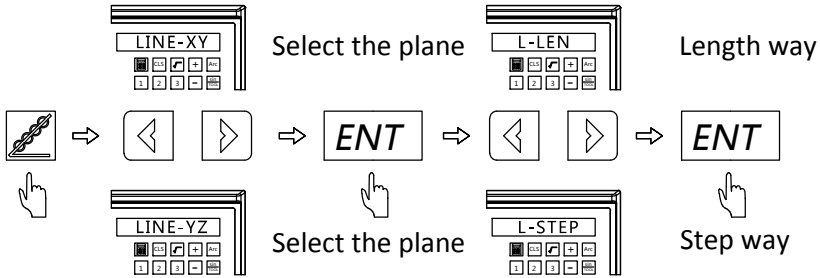

Input Parameter

L-LEN: LENGTH--Overall length of oblique line

(Length from starting hole to end hole,Figure B)

ANGLE--Angle of oblique line (Figure A)

NO HOLE--Number of hole (Figure B)

L-STEP: STEP--Length between two adjacent hole (Figure B)

ANGLE--Angle of oblique line (Figure A)

Example:

NO HOLE--Number of hole (Figure B)

Figure A:

The angle indicates the position direction of the oblique line on coordinate plane. The anti-clockwise direction is the positive direction. The clockwise direction is the negative direction.

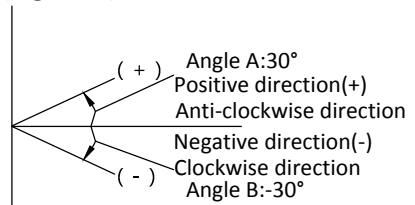

(Figure A)

Figure B:

Length of oblique line:60mm

Angle of oblique line:30°

Length between two adjacent hole:20mm

Number of hole:4

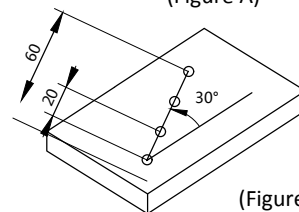



(Figure B)

## Example 1: L-LEN

Step 1: Move the tool to the starting hole.



Press  to enter the PLD function.

Step 2: Press   to select the machining plane,

press **ENT** to confirm.

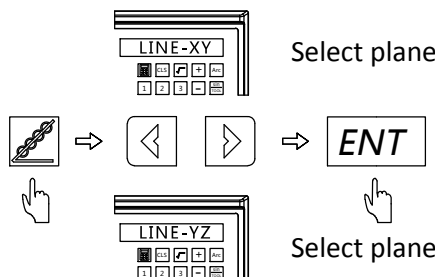
(This step is only available for 3 axis milling machine and 3 axis EDM machine. 2 axis milling machine only gets XY plane. In this way, there is no need to set, enter next setting directly)



Step 3: Press   to select the machining way,

press **ENT** to confirm. (Here we select L-LEN)

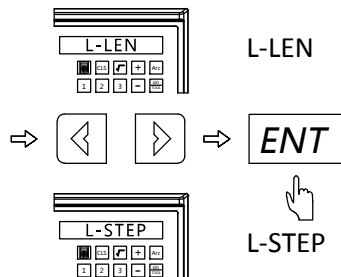

Step 4: Input length

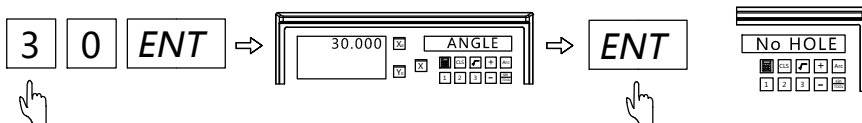
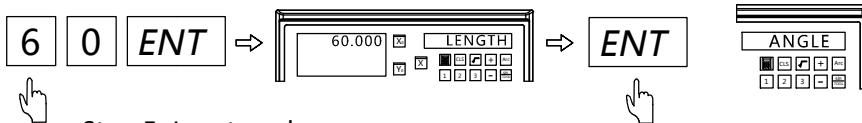



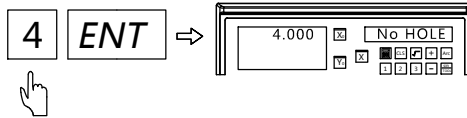

Step 6: Input number of hole

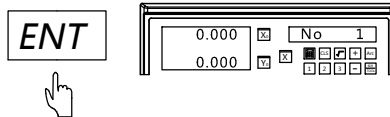

Step 7: Enter the machining status, and the position of first hole will be displayed





Step 8: Press  to enter the next machining point. Move the table until the value of axis become zero. At this time, this zero point indicates the second machining point. Press  to exit PLD function.

Example 2: L-STEP

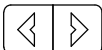

Step 1: Move the tool to the starting hole.

Press  to enter the PLD function.

Step 2: Press  to select the machining plane, press  to confirm.

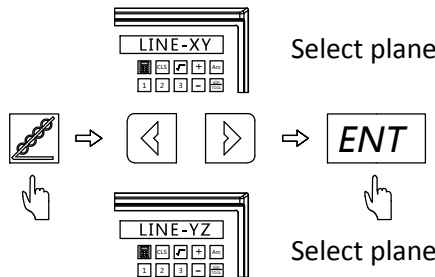
(This step is only available for 3 axis milling machine and 3 axis EDM machine. 2 axis milling machine only gets XY plane. In this way, there is no need to set, enter next setting directly)

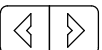

Step 3: Press  to select the machining way, press  to confirm. (Here we select L-STEP)

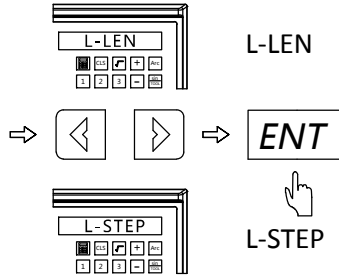

Step 4: Input length

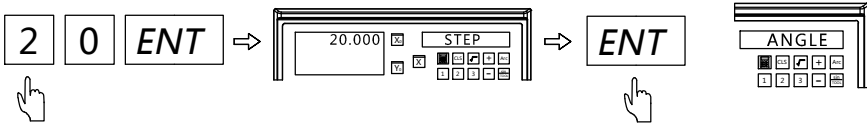

Step 5: Input angle

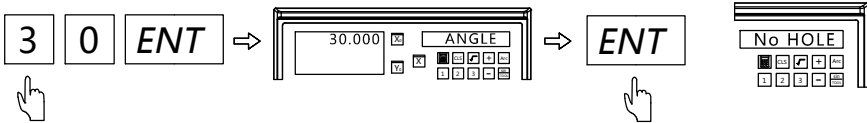

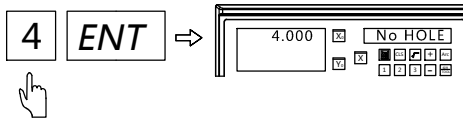

Step 6: Input number of hole

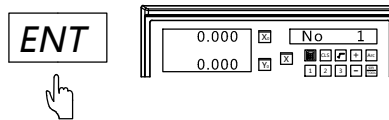

Step 7: Enter the machining status, and the position of first hole will be displayed.



Step 8: Press  to enter the next machining point. Move the table until the value of axis become zero. At this time, this zero point indicates the second machining point. Press  to exit PLD function.

## 4.2 PCD Function

(Applies to 2&3axis milling machine and 3 axis EDM machine)

The DRO provides tool positioning function for drilling equally divided holes on the circle. Users could input the required parameter, the DRO would calculate the position for every hole. Then move the table until the value of axis for every hole become (0.000,0.000), that is the hole position. The required parameters are shown as below:

PCD-XY :Plane Selection

CT-POS :Center of the circle

DIA :Arc diameter



ST-ANG :Starting angle

ED-ANG :End angle

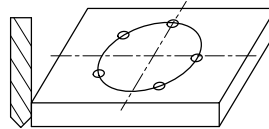
NO HOLE :Number of hole



The DRO will calculate the position

for every hole. User could press  

to select which hole shall be

reached. Then move the table until

the value of axis for every hole

become (0.000,0.000). That is the hole

position.

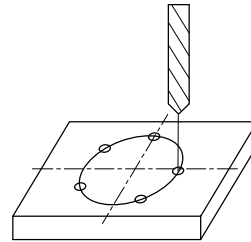

Note: Angle direction

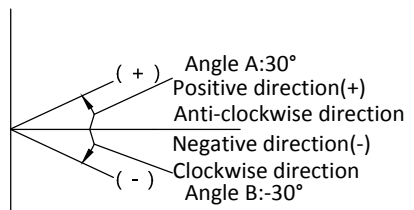

Example: Machining the work-piece as shown in the figure

PCD-XY: Plane XY

Center of the circle ( 0.000 , 0.000 )

Starting angle 0°

CT-POS: Center of the circle

X=0.000,Y=0.000

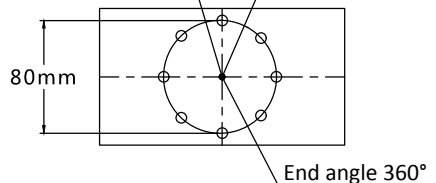

DIA: 80mm arc diameter

ST-ANG: Starting angle 0



Step 1: Set the zero point of work-piece. Zero the value.

Press  to enter PCD function.

Step 2: Press   to select the machining place,  
press **ENT** to confirm.

(This step is only available for 3 axis milling machine and 3 axis EDM machine. 2 axis milling machine only gets XY plane. In this way, there is no need to set, enter next setting directly)

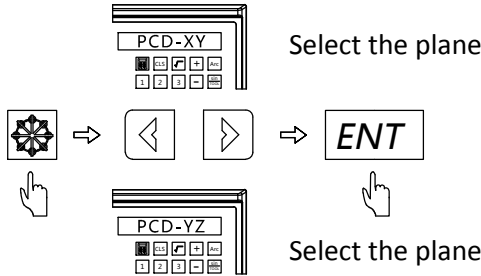

Step 3: Input the center coordinate of circle

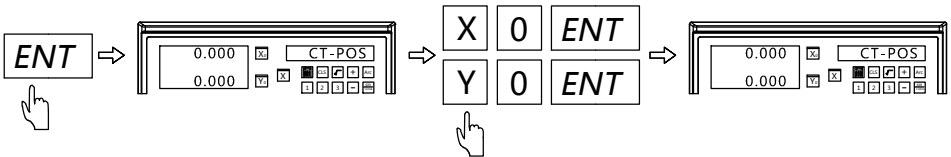

Step 4: Input the diameter of the arc

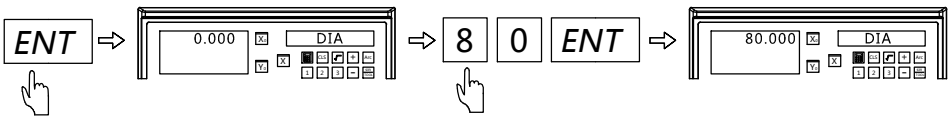

Step 5: Input the starting angle

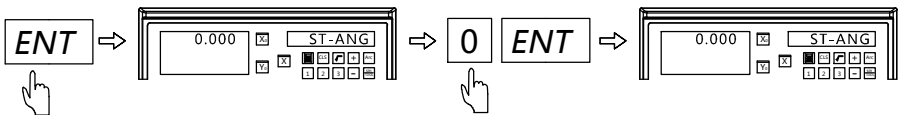

Step 6: Input the end angle

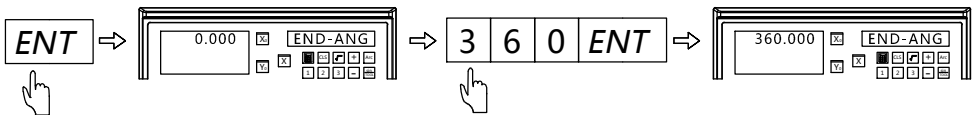

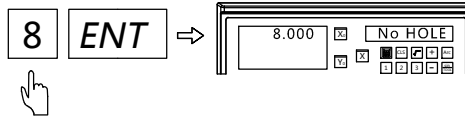

Step 7: Input the number of hole

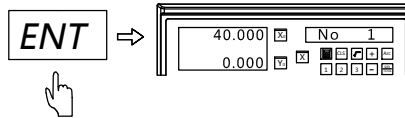

Step 8: Enter the machining status, and the position of first hole will be displayed.



Step 9: Press  to enter the next machining point. Move the table until the value of axis become zero. At this time, this zero point indicates the second machining point. Press  to exit PCD function.

### 4.3 Smooth R Function (Applies to 2&3axis milling machine)

User could use the smooth R function to machine any arc, even an arc to be connected with another arc. (commonly known as R-to-R)

Parameter

PCD-XY: Select the plane (XY/XZ/YZ)      CT-POS: Circle center coordinate

R: Radius of arc      TL-DIA: Diameter of tool

MAX-CUT: Maximum cutting amount      ST-ANG: Starting angle

ED-ANG: End angle

RAD+RL/RAD-RL: Arc machining plane (convex or concave)

3 common arc machining type

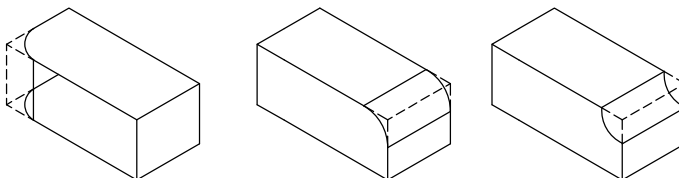

## Machining Steps

1. Locate the zero point of work-piece and zero the value of DRO
2. Enter R function and select smooth R(SMOOTH)
3. Select the plane(ARC-XY,ARC-XZ,ARC-YZ)
4. Input the circle center coordinate(CT-POS)
5. Input the arc radius(R)
6. Input the tool diameter(TL-DIA)
7. Input maximum cutting amount(MAX-CUT)
8. Input the arc starting angle(ST-ANG)
9. Input the arc end angle(ED-ANG)
10. Select the arc machining plane to be RAD+RL or RAD-RL  
(Convex or Concave)

Example: Machining the arc shown as the right figure.

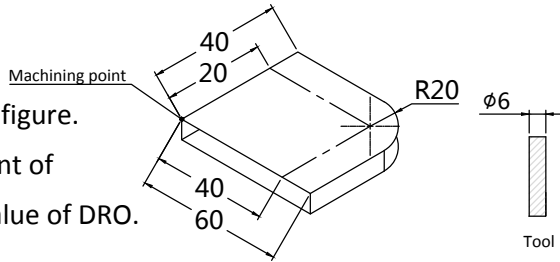

Step 1: Locate the zero point of work-piece and zero the value of DRO.

Step 2: Press  to enter R function and select smooth R



Step 3: Select the machining pane as XY(2 axis DRO contains only XY plane)

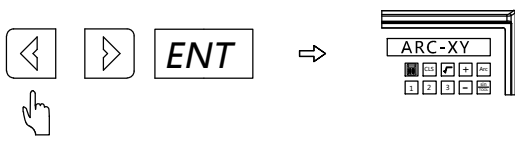

Step 4: Input the circle center coordinate

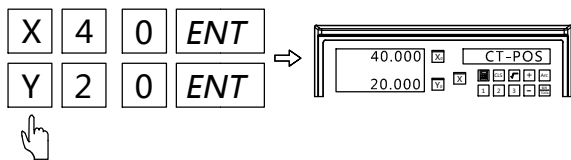

Step 5: Input the arc radius

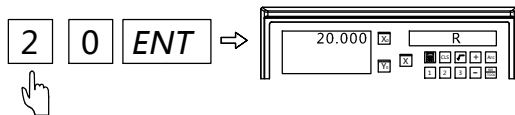

Step 6: Input the tool diameter

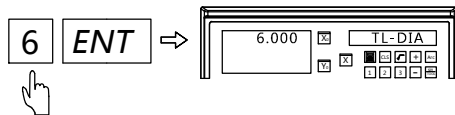

Step 7: Input the maximum cutting amount

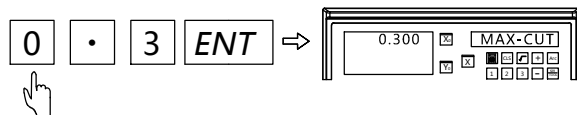

Step 8: Input the starting angle

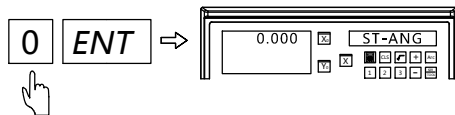

Step 9: Input the end angle

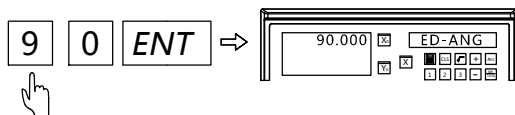

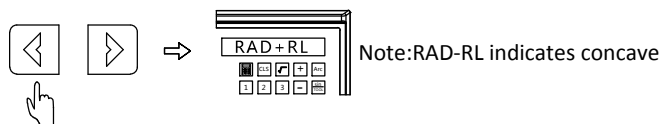

Step 10: Select the arc plane convex

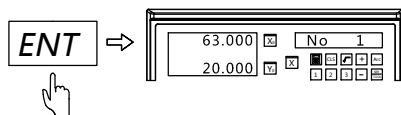

Step 11: Press **ENT** to enter the machining, and the first point will be displayed.



Step 12: Press  to display the following machining point. Move the table until the value of axis become zero, at this time, the zero point indicates the exact position for the machining point. Press  to exit the smooth R function.

### 4.4 Simple R function (Applies to 2&3axis milling machine)

Simple R function enable user to machine the arc with no calculation more easily compared with smooth R function. But it offers only the below 8 machining way.

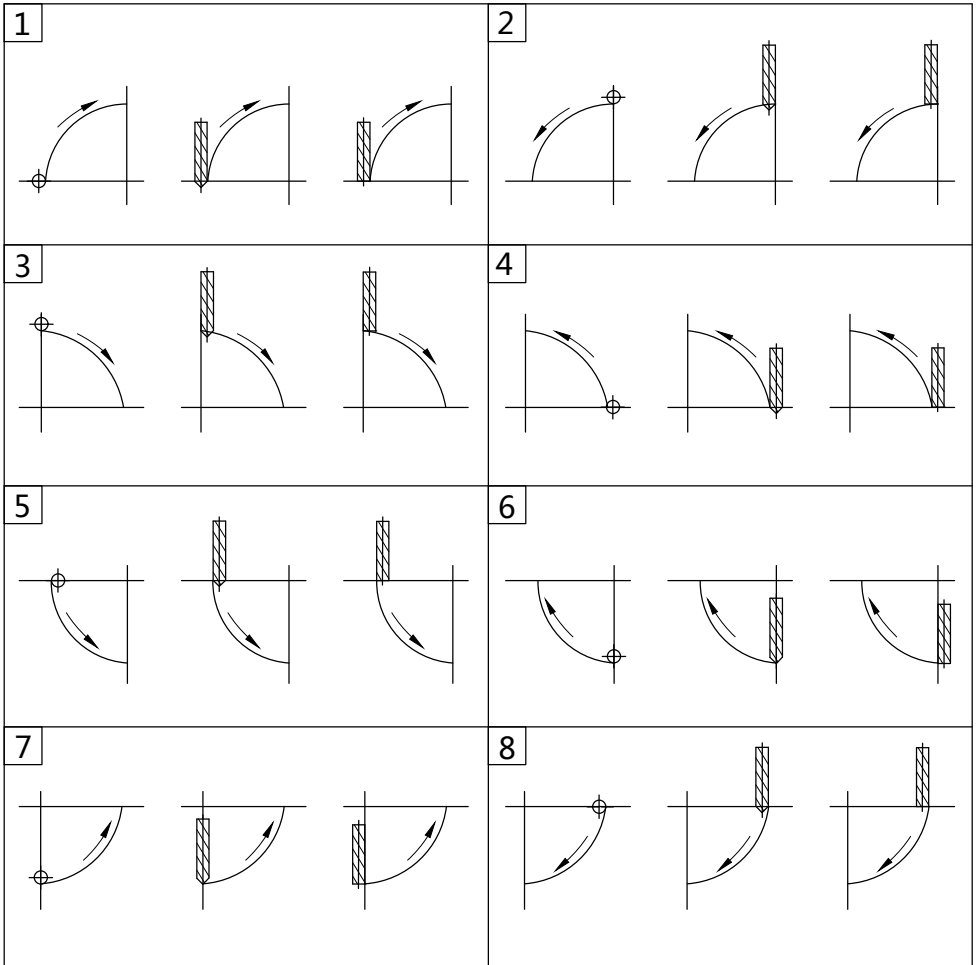





## Operation steps

1. Locate the zero point of work-piece and zero the value of axis
2. Enter the R function and select the simple R (SIMPLE)
3. Select the machining way from the preset 8 options.(TYPE 1-8)
4. Select the plane XY,XZ,YZ(ARC-XY,ARC-XZ,ARC-YZ)
5. Input the arc radius (R)
6. Input the tool diameter (TL-DIA) Note:When using the flat end mill to machine the arc on plane of XZ and YZ,input the tool diameter as 0)
7. Input the maximum cutting amount (MAX-CUT)
8. Select the arc plane as convex or concave(RAD+RL or RAD-RL)
9. Machining the point by turn according to the DRO display.

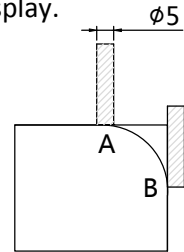
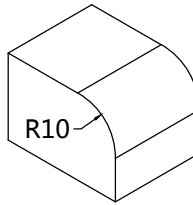
Example:Machine the arc as shown in right figure.



Step 1: Move the tool to the starting point of arc(A or B),press  to enter the R function and select simple R.Press **ENT** to confirm.



Step 2: Select the machining way



Step 3: Select the machining plane as XZ

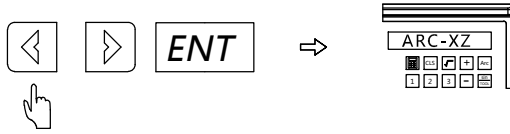

Step 4: Input the radius of arc

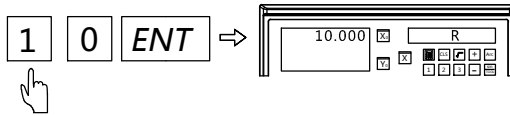

Step 5: Input the diameter of tool

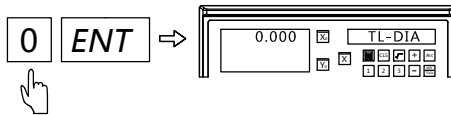

Step 6: Input the maximum cutting amount

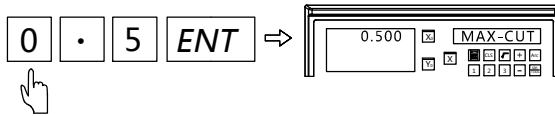

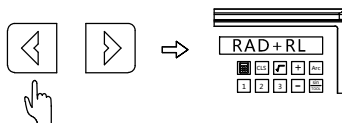

Step 7: Select the arc machining plane as convex



Note: RAD-RL is the concave

Step 8: Press **ENT** to the machining interface, and the first point will be displayed.

Step 9: Press  to display the following machining point. Move the table until the value of axis become zero, at this time, the zero point indicates the exact position for the machining point. Press  to exit the simple R function.

## 4.5 Calculator

Keypad layout of calculator

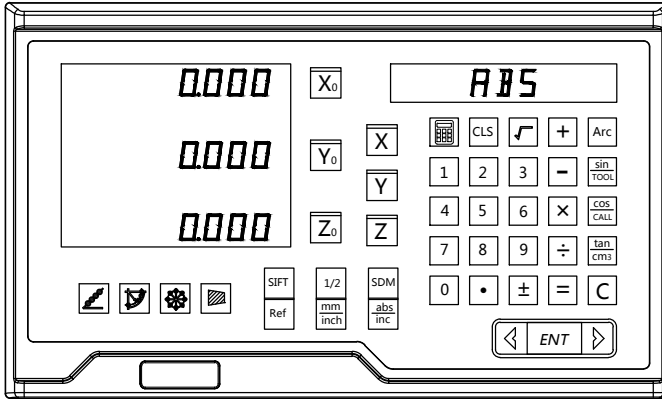

Enter or exit calculator function



Square Root Calculation



Inverse trigonometric function



Trigonometric function



Zero



Data transferring. Press these keys could transfer the calculated data to X, Y and Z axis.

Example 1: Calculate Sin45°

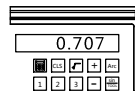

Example 2: Transfer the calculated value to X axis

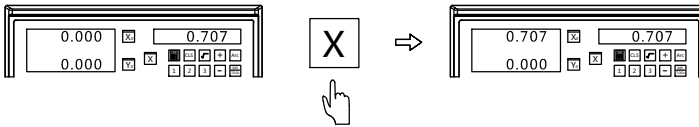

(Same operation to Y and Z axis)



## 4.6 Digital Filtering Function

During machining, the vibration of machine may cause the value displaying change very fast, this could cause the visual discomfort to user. With the digital filtering function, the displayed value will change stably.



Operation

1. Press **SIFT** to enter the digital filtering function. The right window will display the mark .
2. Press **SIFT** to exit digital filtering function. The mark  displayed on right window will disappear.

Note: The digital filtering function is only applicable under ABS, INC and SDM status. Once this function as be activated, other functions cannot be used.

## 4.7 Radius and diameter conversion



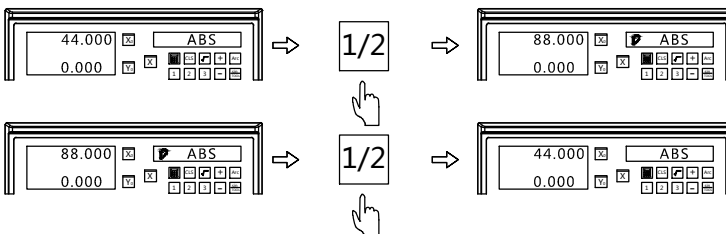

(Applies to 2 axis and 3 axis Lathe)

When the DRO has been set to lathe model. **1/2** has special function. Press **1/2**, the X axis will display as diameter with the mark  on right window. Press **1/2**, X axis will back to radius, while the mark  on right window will disappear.



Note: When the DRO has been set to be lathe model, radius and diameter conversion is only applicable on X axis.

### 4.8 Axis Summing (Applies to 2 axis and 3 axis Lathe)

When 3 axis DRO has been set to be lathe mode. Press , the value of Y and Z axis can be summed and displayed on Y axis, while the right window will display mark . Press  again to get back to normal displaying, and the mark  will disappear.

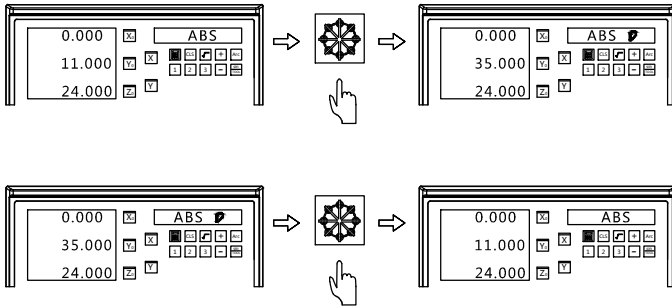

### 4.9 200 sets of tool offset (Applies to 2 axis and 3 axis Lathe)

During machining on lathe, different tools are needed for one kind of work-piece. Finding the zero point again after loading and unloading tool is time-consuming. For this, the DRO provides 200 sets of tool offset.

Note: This function is only applicable once lathe has been equipped with tool post.

Basic Setting:

1. Set a reference tool. After setting well, zero the value of both X and Y axis.
2. Confirm the position of Tool 2 according to the coordinate difference between Tool 1 and reference tool. (Shown in figure A)  
The position of Tool 2 can be calculated as:  $X = 25 - 30 = -5$ ,  $Y = 20 - 10 = 10$ .

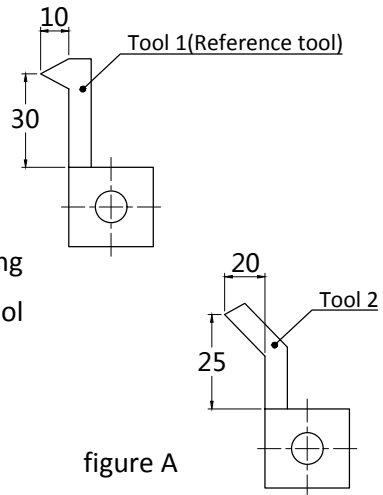



figure A

3. Number the tool, and memorize its position data which is basing the reference tool.

4. When machining, user could input or switch the tool number. Move the carriage until the value of both X and Y axis become 0.

5. Press  $\pm$  10 times. The right window will display TL-OPEN with a mark . This indicates the tool offset function has been activated. Press  $\pm$  10 times again. The right window will display TL-CLOS, and the mark  will disappear. This indicates the tool offset function has been turn off.

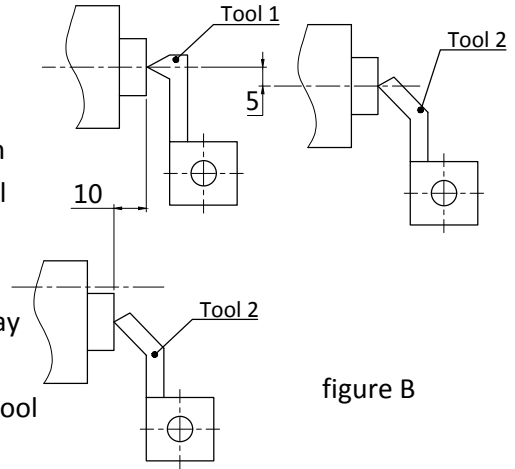
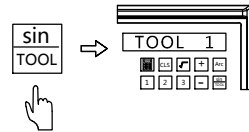

figure B

The operation of setting the tool are as the following:

Step 1: Move the tool 1 to zero point and zero the value. Set the tool 1 as reference tool under ABS model.

Step 2: Press  $\frac{\sin}{\text{TOOL}}$  to enter the tool setting



Step 3: Input the coordinate of tool.

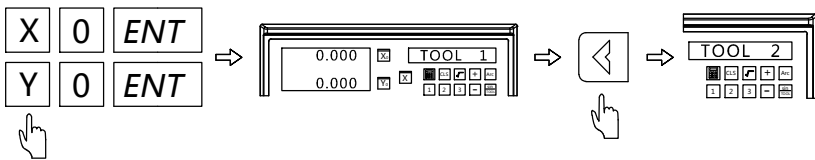

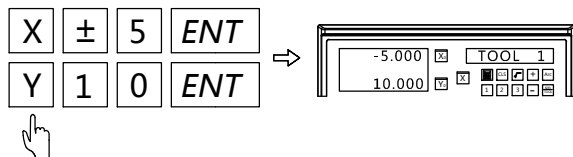

Step 4: Input the coordinate of tool 2.





Step 5: Press  $\triangleright$  to input the coordinate of next tool. Press  $\frac{\sin}{\text{TOOL}}$  to exit the tool setting.

Recall the preset tool:

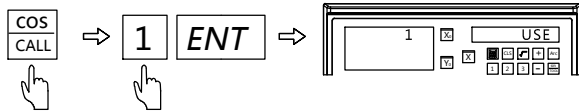
Step 1: Press  to enter the tool using status. We could input the tool number directly. Press  to enter the next parameter.



Step 2: Press   to select the reference tool relative to the current tool. We could input the number directly to select the reference tool.

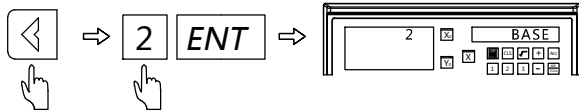

Step 3: Press  to exit. Move the carriage until the value of both X and Y axis become 0. At this time, the second tool has been set at the reference position. Likewise, user could input or recall 200 sets of tool.

Note: We could only zero under ABS model when the current tool (USE) is the same with the reference tool (BASE), or we could only zero under INC model.

## 4.10 Taper Measuring Function (Applies to 2 axis and 3 axis Lathe)

When machining the work-piece with taper, this function enable user to measure the taper of work-piece.

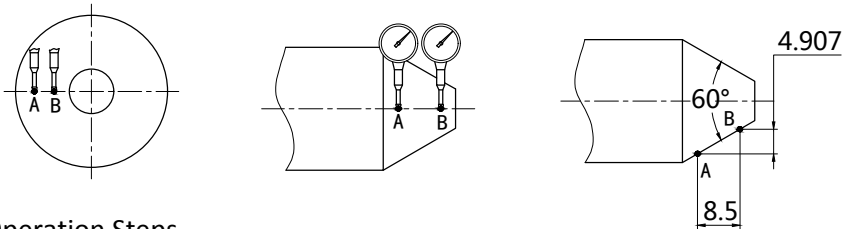

### Operation Steps

Make the dial test indicator to contact the point A. Press until the value on dial test indicator become 0. (Figure A) Then zero the X and Y axis.

Step 1: Press  to enter the taper measuring function.

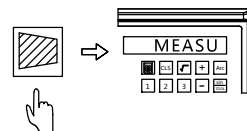

Step 2: Move the table to press the position B until the value on dial test indicator become 0.

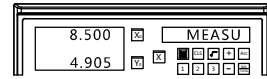

Step 3: Press **ENT** to calculate  
 X axis displays taper  
 Y axis displays the angle

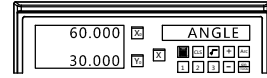

Step4: Press  to exit.

## 4.11 EDM Function

### 1. Function Introduction

This function is for EDM machining. When current value is equal to the preset value, the DRO will output a on/off signal to stop the EDM machining.

The direction setting of Z axis is shown in figure 1, i.e. the depth is larger, and the value on Z axis will be larger.

According to the set direction of Z axis. The machining direction gets negative and positive. When the electrode goes down, the machining direction is from upper to lower, the value on Z axis become larger. We call this as positive direction (Positive). When the electrode goes up. The machining direction is from lower to upper, and the value of Z axis will decrease. We call this negative machining direction (Negative) (Shown in figure 1)

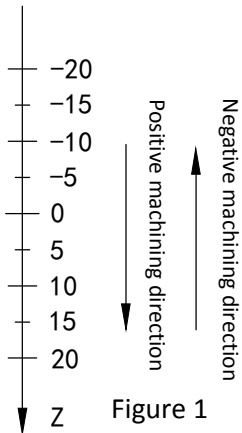

Figure 1

This DRO also gets fire prevention for reverse height. This is an intelligent position following function for safety. When the electrode gets carbon deposition for positive direction machining, especially for long time machining with no supervision. The carbon deposition will increase on electrode.



Once the electrode exceed the liquid level,the fire may be brought.This function will alarm and output a off signal for machining once the electrode exceed the liquid level.(Figure 2)

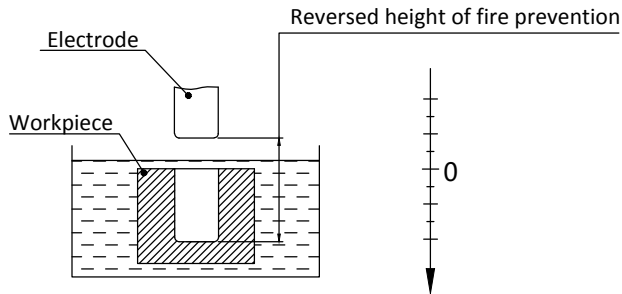

Figure 2

## 2. Operation Steps:

- (1): Set the parameter of fire prevention of reverse height,exit mode, machining direction and EDM mode before machining.
- (2): Move the electrode on spindle to make it contact with the surface of work-piece,and zero or input value.
- (3): Press  to input the machining height.(The height will be displayed on X axis)Then press  to confirm.Press  to exit DEPTH setting and back to machining interface.
- (4): X axis will display the target height.  
Y axis will display the reached height.  
Z axis will display the current position of electrode.
- (5): Once started machining,the value on Z axis will get close to target value gradually.The value on Y axis will also get close to the target.If the electrode goes up and down now,the value on Z axis will change accordingly.While the value on Y axis will remain same which is the reached height value.

(6): When the value on Z axis is equal to preset height value. The EDM machining will stop. The right window will display EDM END. There are two ways to exit the function. One is automatic exit once the preset height has been reached. The other is to press **SIFT** to exit. Before the exit, the right window will display EDM END to remind.

### 3. Fire Prevention of Reverse Height(ERRHIGH), Exit Model and Machining Direction Setting(This setting could be done before machining)

Step 1: Zero all axis and press **SIFT** to enter the EDM function.

Press **◀** **▶** to set the different parameter.

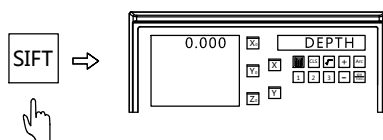

Step 2: Press **▶** to set the fire prevention of reverse height.

Here we input -150.

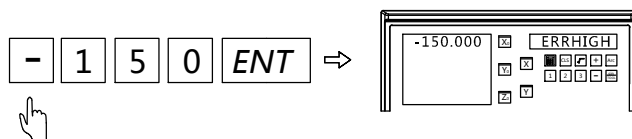

Step 3: Set the machining direction. The defaulted is positive direction.

Press **0** to choose the negative direction(NEGATIV)

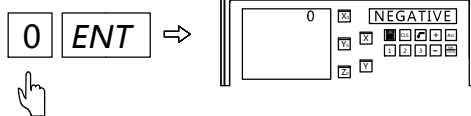

Press **1** to choose the positive direction(POSITIV)

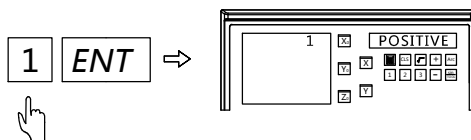

Step 4: Enter exit model setting. The defaulted is automatic exit.

Manual exit

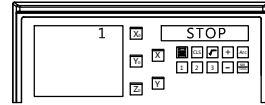
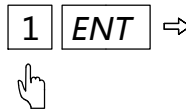

Automatic exit

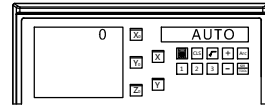
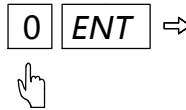

Step 5: Select the EDM machining mode. The defaulted is mode 0.

Press **0** to select mode 0. The output of relay are shown as below:

- a. When power off, the relay coil is OFF.
- b. When the CPU is not initialized, the relay coil is OFF
- c. When output 1 under normal status after the DRO power on, the relay coil is ON.
- d. When output 1 once the EDM function has been activated, the relay coil is ON.

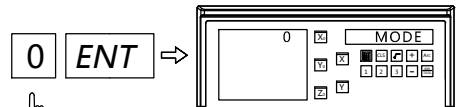

e. When output 0 once the target height has been reached, the relay coil is OFF.

Press **1** to select mode 1. The output of relay are shown as below:

- a. When power off, the relay coil is OFF.
- b. When the CPU is not initialized, the relay coil is OFF
- c. When output 0 under normal status after the DRO power on, the relay coil is OFF.
- d. When output 1 once the EDM function has been activated, the relay coil is ON.

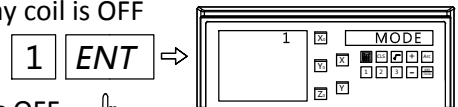

e. When output 0 once the target height has been reached, the relay coil is OFF.

## 4. Example of positive direction machining

Example 1: Machining the work-piece shown in figure A

Work-piece and electrode are shown in figure B.

Confirm the machining direction as positive.

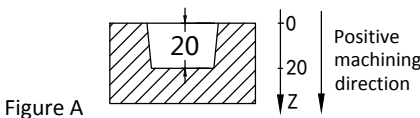

Figure A

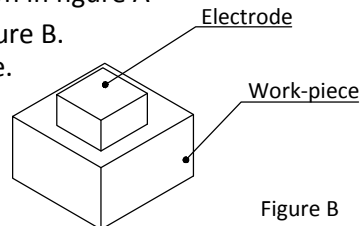
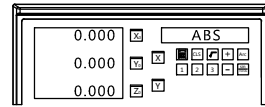

Figure B

Step 1: Move the electrode to make it contact with the work-piece

Press **X<sub>0</sub>** **Y<sub>0</sub>** **Z<sub>0</sub>** to zero(Figure B)



Step 2: Press **SIFT** to enter the setting

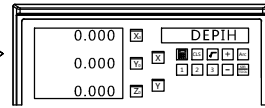

Step 3: Input the target machining height,

press **ENT** to confirm.

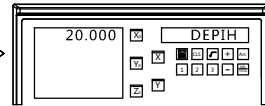
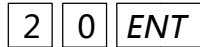

Step 4: Press **ENT** again to start machining.

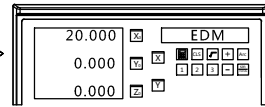

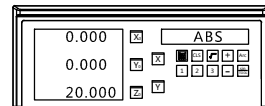
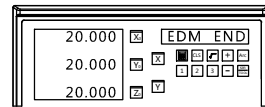

Step 5: When the value on Z axis is equal to the preset height.The machining will stop.The right window will display EDM END for about 3 seconds.Then the DRO will exit this function and back to normal status.





### 5. Combination using of PCD and EDM function.

When using the PCD function,we could also use the EDM function to complete the EDM machining for PCD.Detail operations are shown as below:

- (1) Press  to enter the parameter setting of PCD.(refer the instruction of PCD setting) After setting well,press **ENT** to start machining.And the first position of hole will be displayed.Move the table until the value of axis become 0 to make the electrode align the first machining hole.
- (2) Press **SIFT** to enter EDM parameter setting(refer the instruction of EDM setting).Input the target height and start machining.Once machining completed,press **SIFT** to get exit EDM function and get back to PCD function.Then press  to the next hole.

## 6. Combination using of PLD function and EDM function.

When using the PLD function, we could also use the EDM function to complete the EDM machining for PLD. Detail operations are shown as below:

- (1) Press  to enter the parameter setting of PLD. (refer the instruction of PLD setting) After setting well, press ENT to start machining. And the first position of hole will be displayed. Move the table until the value of axis become 0 to make the electrode align the first machining hole.
- (2) Press SIFT to enter EDM parameter setting (refer the instruction of EDM setting). Input the target height and start machining. Once machining completed, press SIFT to get exit EDM function and get back to PLD function. Then press  to the next hole.

## 7. Switching display model during EDM machining

When in EDM machining process, user could press • to switch the display to be normal displaying. At this time, the right window will display EDM-P. Press • again to switch back EDM machining displaying. The display switching will not affect the EDM machining.

## 8. Output Port

Parameter:

1.0A30VC, 0.5A125VAC, 0.3A60VDC

DB9 Pin	Signal Type	Pin Color
1	OFF	Black
3	COM	Yellow
5	NO	Red

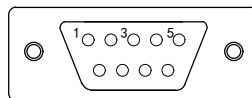

## 5. Appendix

1. Parameter
2. Dimension
3. Troubleshooting

## 5.1 Parameter

1. Voltage: AC 80V--260V ; 50-60HZ
2. Power: 15W
3. Working Temperature: -10°C--60°C
4. Storage Temperature : -30°C--70°C
5. Relative Humidity : <90% ( 25 ) >
6. Axis Number: 1 axis,2 axis,3 axis
7. Input Signal: 5V TTL/5V RS422
8. Input signal Frequency: <50MHZ
9. Resolution (Linear Encoder): 0.1 um, 0.2 um, 0.5 um, 1 um, 2 um, 2.5 um , 5 um , 10 um
10. Highest Resolution(Rotary Encoder): <1000000ppr
11. Weight: 1.5KGS
12. Dimension:295\*175\*65mm
13. DB9 Pin diagram

### DB9-5V TTL

Pin	1	2	3	4	5	6	7	8	9
Signal	Empty	0 V	Empty	Shield	Empty	A	+5 V	B	R
Color		Black		Shielding		Yellow	Red	Green	Brown

### DB9-5V RS422

Pin	1	2	3	4	5	6	7	8	9
Signal	A-	0 V	B-	Shield	Z-	A	+5 V	B	R
Color	Orange	Black	Blue	Shielding	White	Yellow	Red	Green	Brown

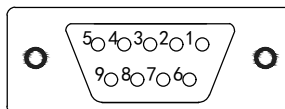

## 5.2 Dimension

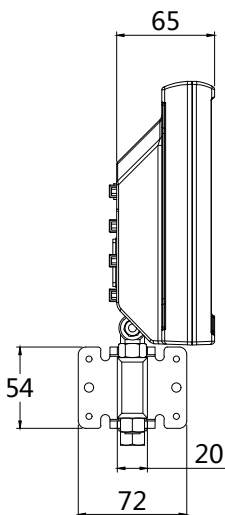
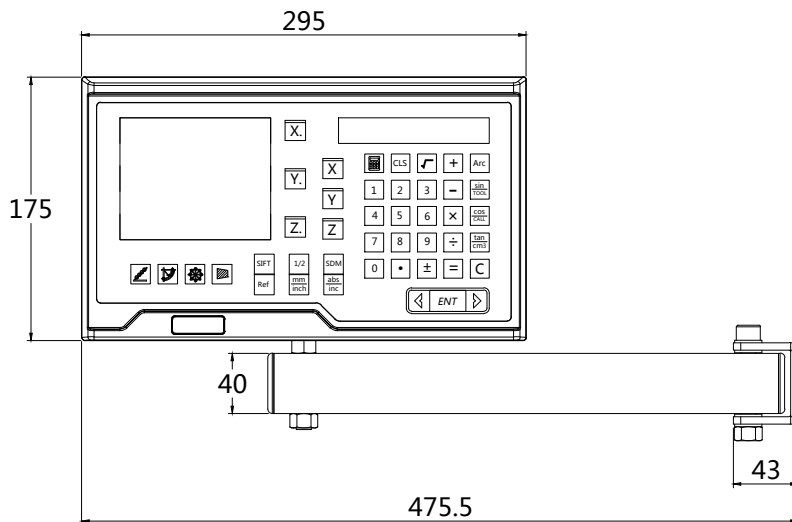



### 5.3 Troubleshooting

The following troubleshootings are just the preliminary methods. If the problems still exist, please do not dismantle the DRO by yourself, but contact our company or the dealers for help in time.

Faults	Fault Causes	Solutions
The DRO doesn't display anything	<ol style="list-style-type: none"> <li>1. The power is not on ?</li> <li>2. The power switch is not closed ?</li> <li>3. The supply voltage is not appropriate</li> <li>4. The internal supply of the grating ruler is in short circuit.</li> </ol>	<ol style="list-style-type: none"> <li>1. Check whether the power line and power plug are plugged in.</li> <li>2. Close the power switch.</li> <li>3. Make sure the supply voltage between 80V-260V.</li> <li>4. Pull out the connector of the grating ruler.</li> </ol>
One axis of the DRO doesn't count	<ol style="list-style-type: none"> <li>1. Operate the machine after swapping with the grating ruler of another axis.</li> <li>2. Some special functions of the DRO are being used.</li> </ol>	<ol style="list-style-type: none"> <li>1. If counting, it's the fault of the grating ruler; if not, it's the fault of the DRO.</li> <li>2. Exit the special function</li> </ol>
The counting of DRO is not accurate (it can't zero)	<ol style="list-style-type: none"> <li>1. The grating ruler isn't installed according to the requirements or the accuracy is not enough.</li> <li>2. After being used for a long time, the vibration of the machine tool makes the fixed reading head or the screws loosen.</li> <li>3. The accuracy of the machine tool is not good.</li> <li>4. The DRO resolution isn't consistent with the grating ruler.</li> </ol>	<ol style="list-style-type: none"> <li>1. Reinstall the grating ruler and adjust the level.</li> <li>2. Tighten all the fixed screws.</li> <li>3. Overhaul the machine tool.</li> <li>4. Reset the DRO resolution.</li> </ol>
The counting of DRO is in error, The displayed operation distance isn't consistent with the actual distance	<ol style="list-style-type: none"> <li>1. The machine tool and the DRO shell are not connected to earth.</li> <li>2. The accuracy of the machine tool is not good.</li> <li>3. The running speed of the machine tool is too fast.</li> <li>4. The grating ruler isn't installed according to the requirements and the accuracy is not enough.</li> <li>5. The DRO resolution isn't consistent with the grating ruler.</li> <li>6. The operating size unit is not consistent with the displayed Metric/British units.</li> <li>7. The linear error compensation setting of the DRO is not appropriate.</li> <li>8. The grating ruler exceeds the operating range of length or the read head is broken.</li> </ol>	<ol style="list-style-type: none"> <li>1. Connect the machine tool and the DRO shell to earth.</li> <li>2. Overhaul the machine tool.</li> <li>3. Reduce the running speed of the machine tool.</li> <li>4. Reinstall the grating ruler and adjust the level.</li> <li>5. Reset the DRO resolution.</li> <li>6. Switch the displayed Metric/British units.</li> <li>7. Reset the linear error compensation of the DRO.</li> <li>8. Repair the grating ruler.</li> </ol>

Faults	Fault Causes	Solutions
<p>The grating ruler doesn't count</p>	<ol style="list-style-type: none"> <li>1. The grating ruler exceeds the operating range of length or the read head is broken.</li> <li>2. The read head of grating ruler rubs the ruler shell leading to the aluminum scraps accumulated.</li> <li>3. The gap between the read head of grating ruler and the ruler body is too wide.</li> <li>4. The metal tubes of the grating ruler are damaged, which causing the short circuit or disconnection in internal wiring.</li> </ol>	<ol style="list-style-type: none"> <li>1. Repair the grating ruler</li> <li>2. Repair the grating ruler</li> <li>3. Repair the grating ruler</li> <li>4. Repair the grating ruler</li> </ol>
<p>The grating ruler doesn't count sometimes</p>	<ol style="list-style-type: none"> <li>1. The small box of the grating ruler is separated from the steel ball.</li> <li>2. The grating glass in the read head of the grating ruler is abraded.</li> <li>3. There is dirt on the grating glass in the shell of the grating ruler.</li> <li>4. The elasticity of small box spring in the read head of the grating ruler is not enough.</li> </ol>	<ol style="list-style-type: none"> <li>1. Repair the grating ruler</li> <li>2. Repair the grating ruler</li> <li>3. Repair the grating ruler</li> <li>4. Repair the grating ruler</li> </ol>

ABS

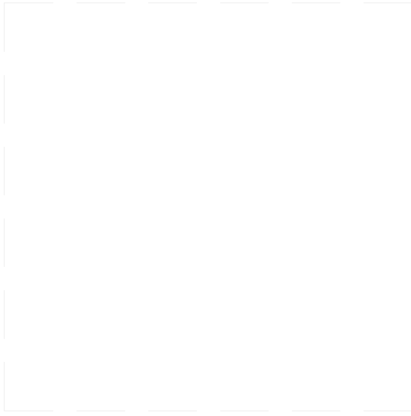

X  
Y  
Z

X<sub>0</sub>  
Y<sub>0</sub>  
Z<sub>0</sub>

0.0000

0.0000

0.0000

**DIGITAL READOUTS** —

**Operation Manual**  
(Version 2.0)

*Driven by Innovation*