

№	axb	x	№	axb	x
1	1738x350	2	14		
2	1738x384	1	15		
3	1006x334	2	16		
4	350x334	2	17		
5	352x334	2	18		
6	342x350	6	19		
7	384x334	2	20		
8	1100x350	1	21		
9	1100x350	1	22		
10			23		
11			24		
12			25		
13			26		

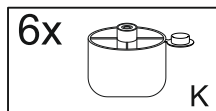
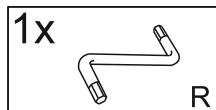
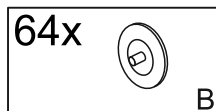
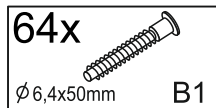

(ENG)

## Bookcase "KSH-4"

(UA)

## Шафа книжкова "КШ-4"

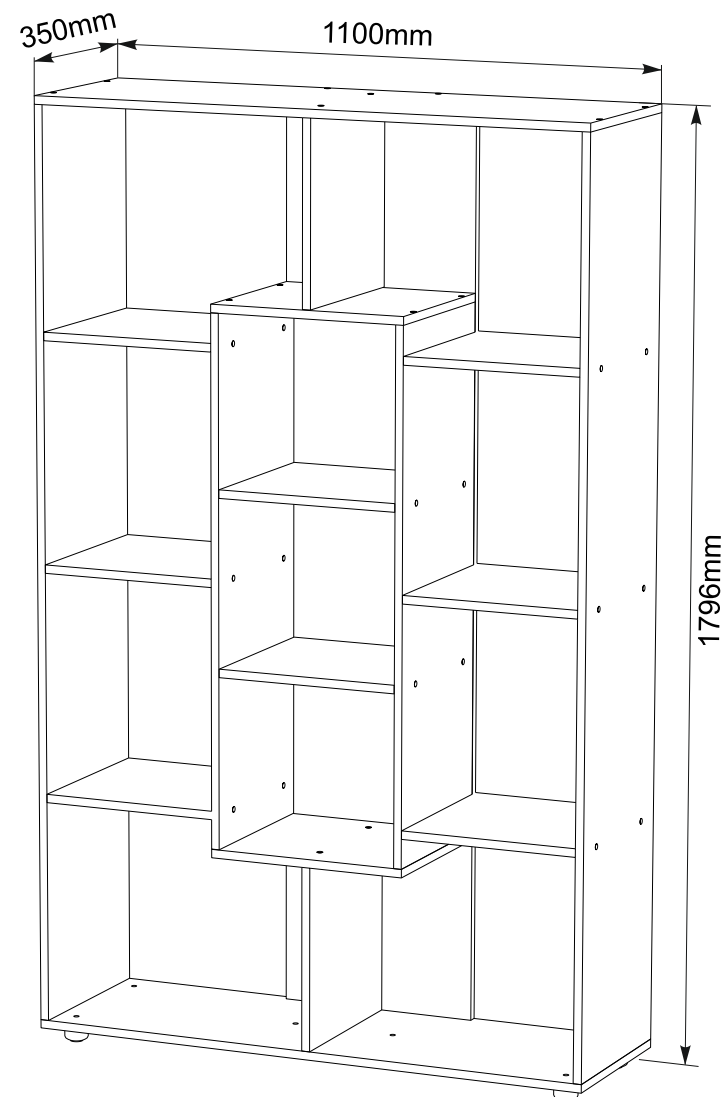

**Bookcase "KSH-4"**  
**Шафа книжкова "КШ-4"**

1

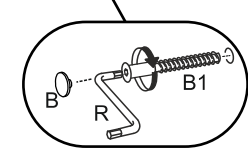
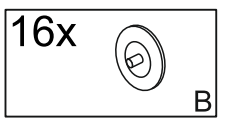
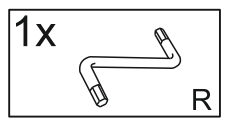
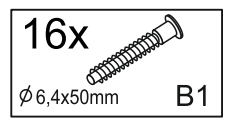
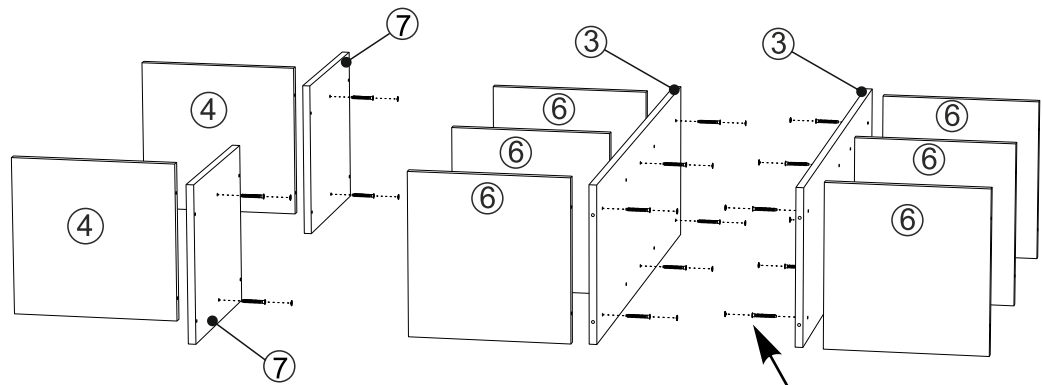
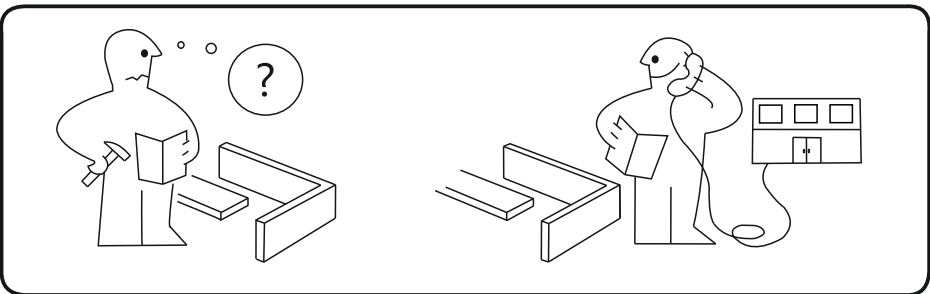
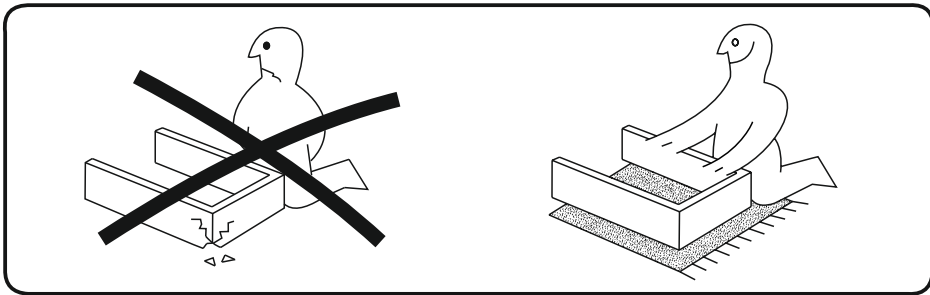
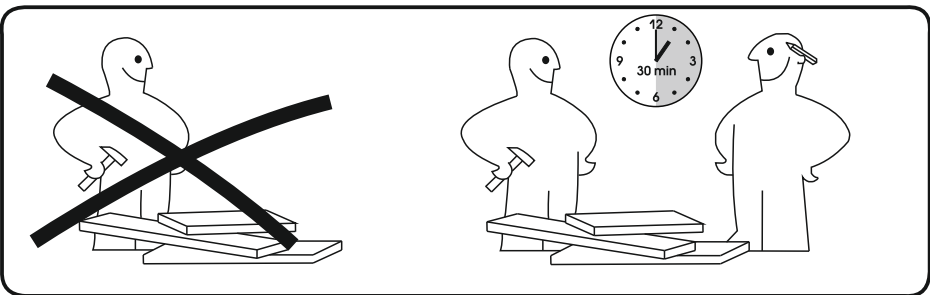
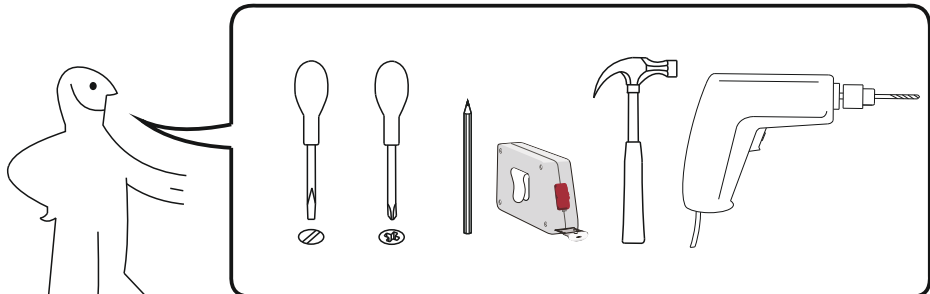

2

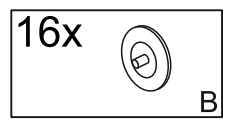
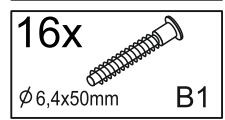
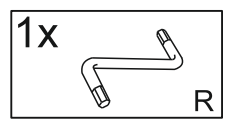
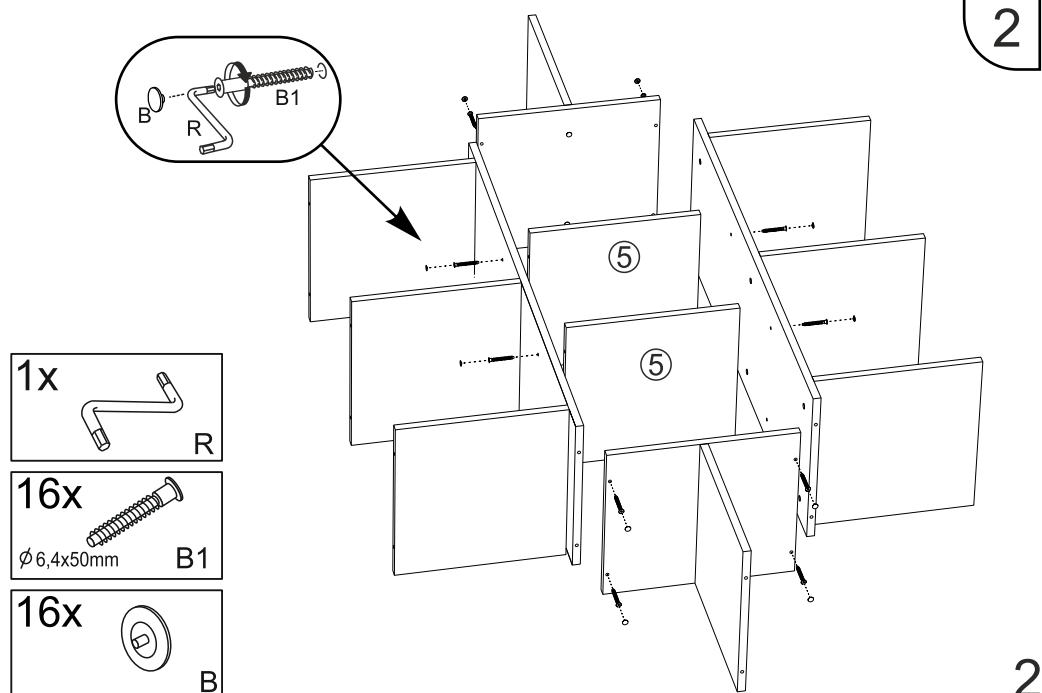

2

3

Bookcase "KSH-4"  
Шафа книжкова "КШ-4"

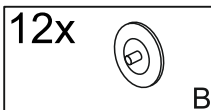
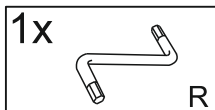
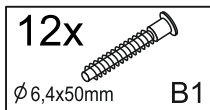
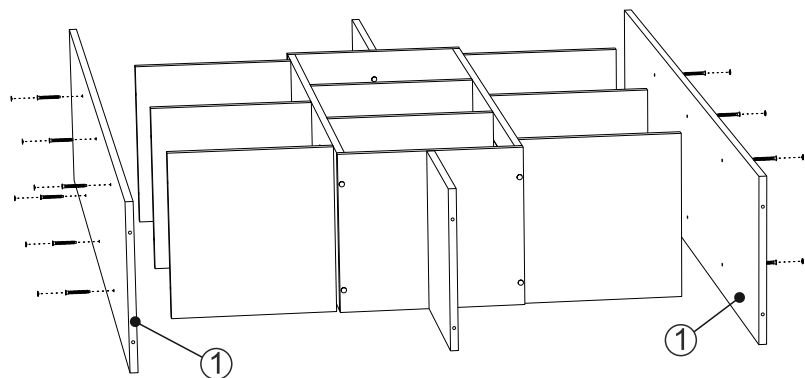

4

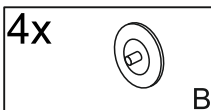
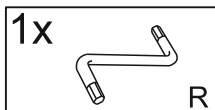
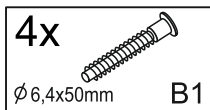
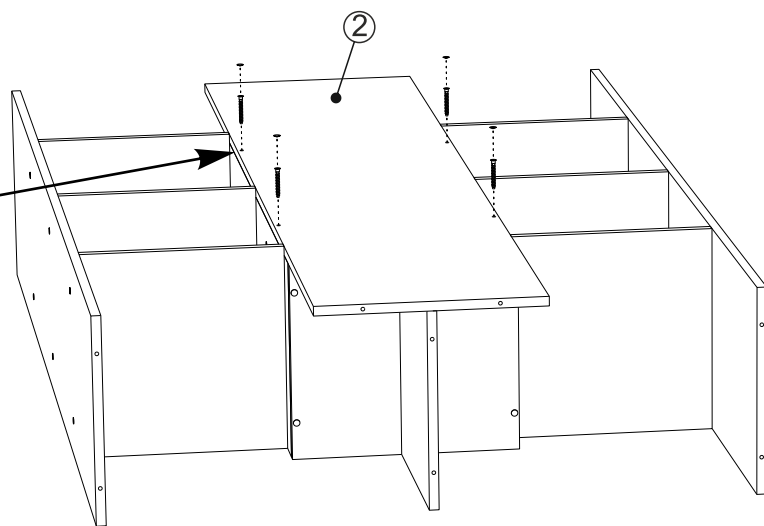
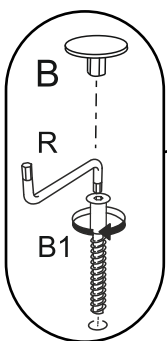

5

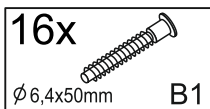
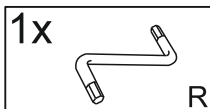
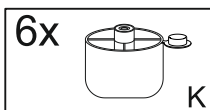
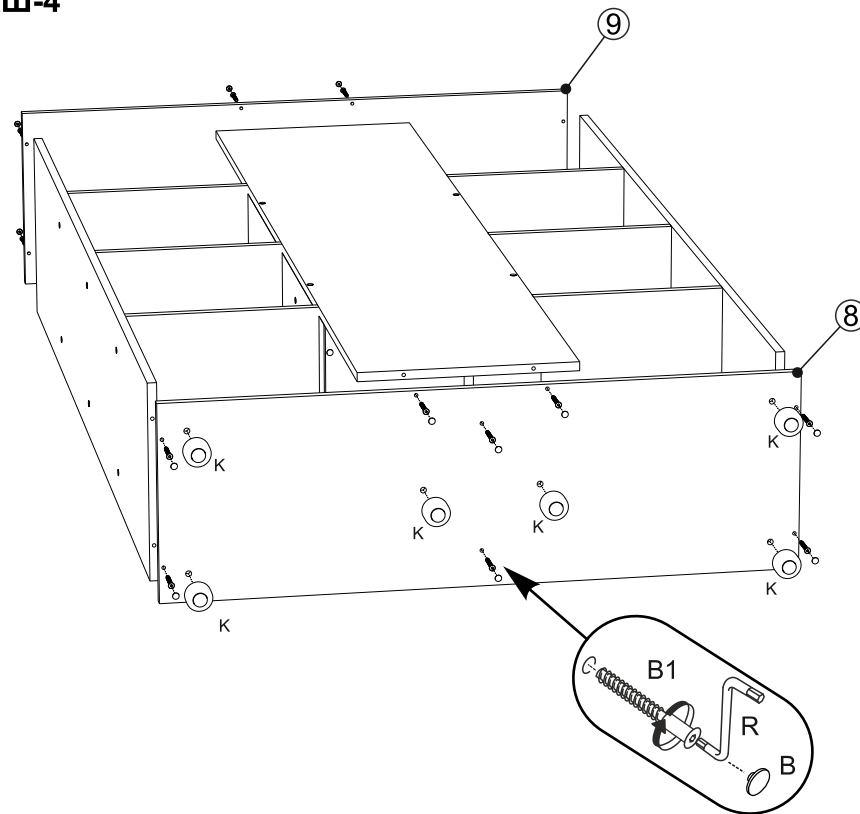

3

# Bookcase "KSH-4" Шафа книжкова "КШ-4"

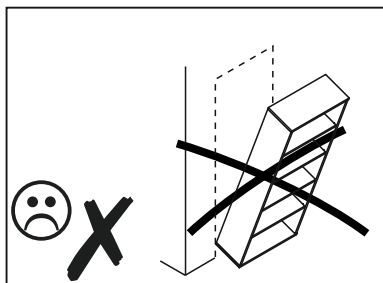
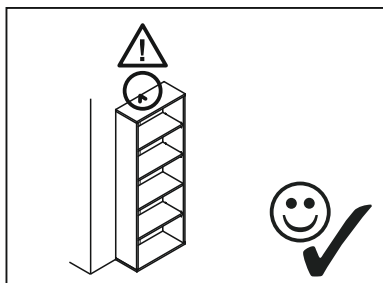
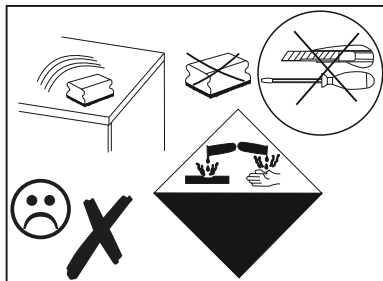
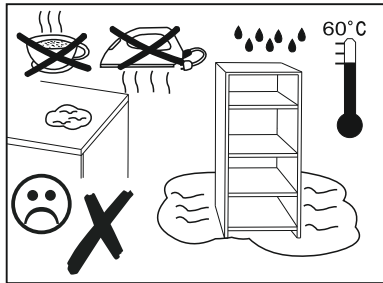
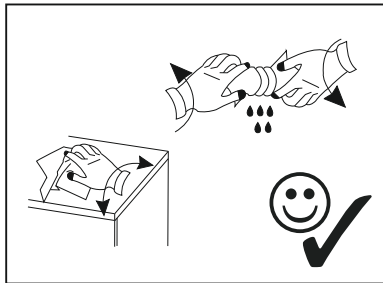
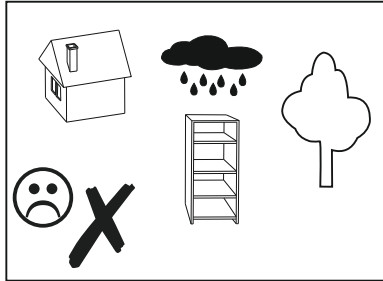
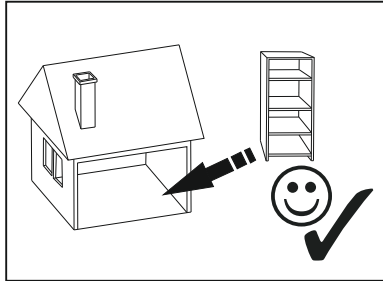

<p>Important information Read carefully. Keep this information for further reference.</p> <p><b>(GB) WARNING</b></p> <p>Serious or fatal crushing injuries can occur from furniture tip-over. To prevent this furniture from tipping over it must be permanently fixed to the wall.</p> <p>Fixing devices for the wall are not included since different wall materials require different types of fixing devices. Use fixing devices suitable for the walls in your home. For advice on suitable fixing systems, contact your local specialized dealer.</p>	<p>Wichtige Information Sorgfältig lesen Diese Information aufbewahren</p> <p><b>(DE) ACHTUNG</b></p> <p>Wenn Möbelstücke umkippen, können ernste oder lebensgefährliche Verletzungen durch Einklemmen die Folge sein. Um zu verhindern, dass das Möbelstück umkippt, muss es fest an der Wand verankert werden.</p> <p>Beschläge für die Wandbefestigung sind nicht beigegeben, da sie von der jeweiligen Wandbeschaffenheit abhängig sind. Befestigungsbeschläge benutzen, die für die heimischen Wände geeignet sind. Bei diesbezüglichen Fragen den örtlichen Fachhandel zu Rate ziehen.</p>	<p>Ważne informacje Przeczytaj uważnie. Zachowaj ulotkę na przyszłość.</p> <p><b>(PL) UWAGA</b></p> <p>Przewrócenie sięmebli może doprowadzić do poważnych obrażeńlubśmierci. Aby zapobiec przewróceniu sięmebli, należy na stałe przymocowaćdościany.</p> <p>W zestawie nie znajdująsięzadneśruby mocujące, ponieważróżne rodzajeścian wymagająróżnych typówśrub. Użyjśrub odpowiednich dościan w Twoim domu. W przypadku wątpliwości, jakich śrub użyć, skontaktuj sięz najbliższym specjalistycznym sklepem.</p>
<p>Information importante A lire attentivement. Conserver ces informations pour un usage ultérieur.</p> <p><b>(FR) AVERTISSEMENT</b></p> <p>Risque de blessure grave en cas de chute du meuble. Pour éviter que le meuble ne bascule, il faut le fixer aumur de façon permanente.</p> <p>Les fixations ne sont pas incluses car leur choix dépend du matériau du mur sur lequel est fixé le meuble. Utilisez des fixations adaptées au matériau du mur. Pour obtenir des conseils sur les fixations à utiliser, adressez-vous à un revendeur spécialisé.</p>	<p>Informații importante Citește cu atenție. Păstreazăaceste informații pentru referințe ulterioare.</p> <p><b>(RO) ATENȚIE</b></p> <p>Pot surveni răni grave dacăte împiedici de obiectele de mobilier. Pentru prevenirea rănilor, fixeazămobila pe perete.</p> <p>Accesorii de fixare pentru perete nu sunt incluse deoarece materialele diferite din care sunt făcuți pereții au nevoie de accesorii diferite de fixare. Folosește accesorii de fixare potrivite pentru pereții camerei tale. Contacteazăun specialist dacănuștii care sunt accesorii potrivite pereților casei tale.</p>	<p>Важлива інформація Прочитайте уважно Збережіть цю інструкцію</p> <p><b>(UA) УВАГА</b></p> <p>Падіння незакріплених меблів може спричинити серйозне або смертельне травмування людини. Щоб запобігти перекиданню цих меблів, їх слід міцно прикріпити до стіни</p> <p>Кріплення до стіни не додаються, оскільки різні матеріали потребують різних кріплень. Використовуйте кріпильні пристрої, які пасують матеріалу Ваших стін. За порадою щодо належних систем кріплення звертайтеся у місцеву спеціалізовану крамницю.</p>