



12x  
  
 ø 4x35 mm N3

6x  
  
 H1

12x  
  
 U

4x  
  
 L

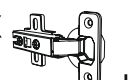
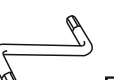
1x  
  
 R

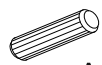
28x  
  
 ø 8x30 A1

14x  
  
 B

64x  
  
 ø 3.5x16 mm E3

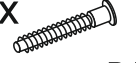
22x  
  
 ø 6,4x50mm B1

4x  
  
 L=400 mm M3

70x  
  
 Q

8x  
  
 E10

4x  
  
 K2

No	a x b	x	No	a x b	x
1	836X448	1	11	412x186	2
2	800X427	2	12	412x186	2
3	834X427	1	13	790x415	2
4	427x371	1	14	400x365	4
5	427x371	1	15		
6	834x427	1	16		
7	800x60	1	17		
8	412x375	2	18		
9	400x100	8	19		
10	335x100	4	20		

 - DVP/ДВП

(ENG) **Commode "Commode-2+4"**

(UA) **Комод "Комод-2+4"**

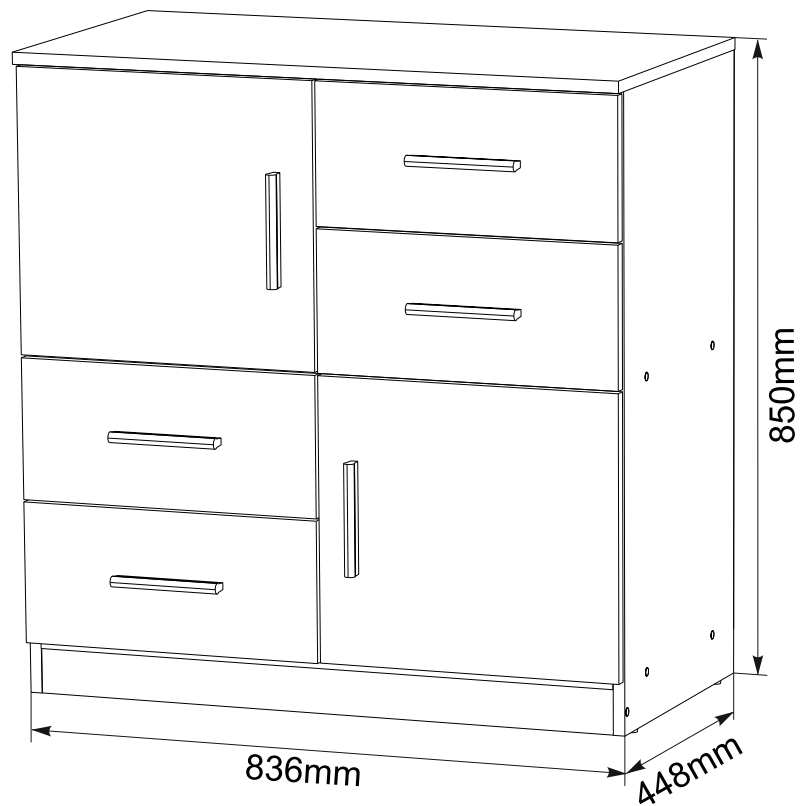

**“Commode-2+4”**  
**“Комод-2+4”**

1

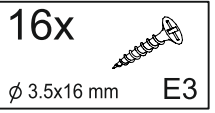
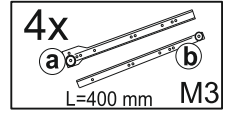
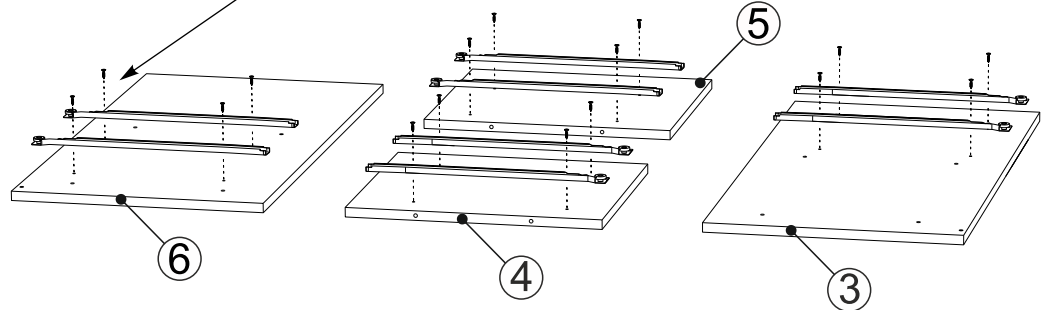
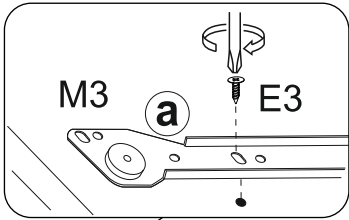
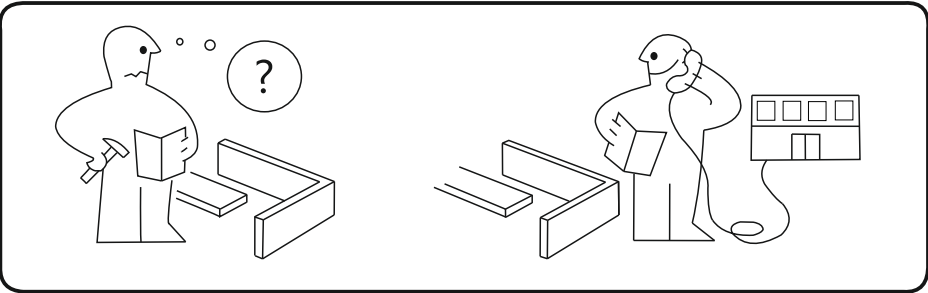
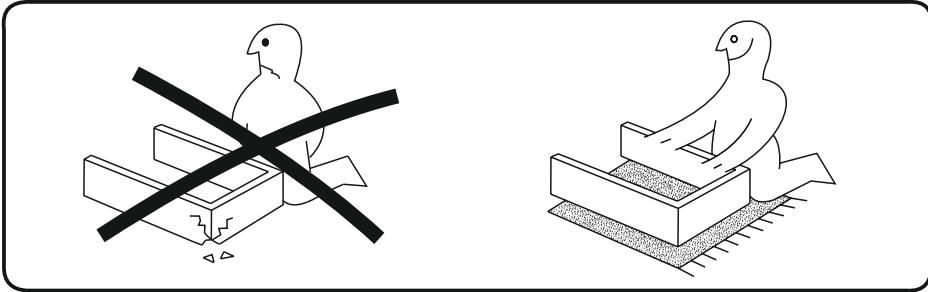
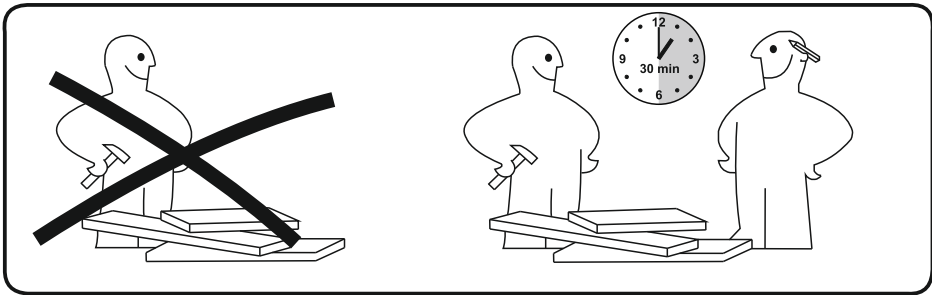
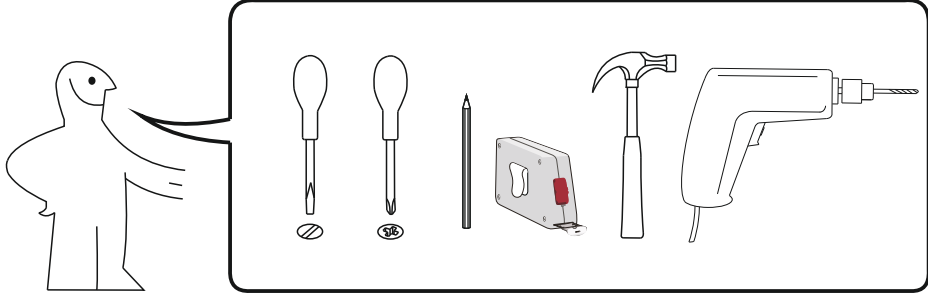

2

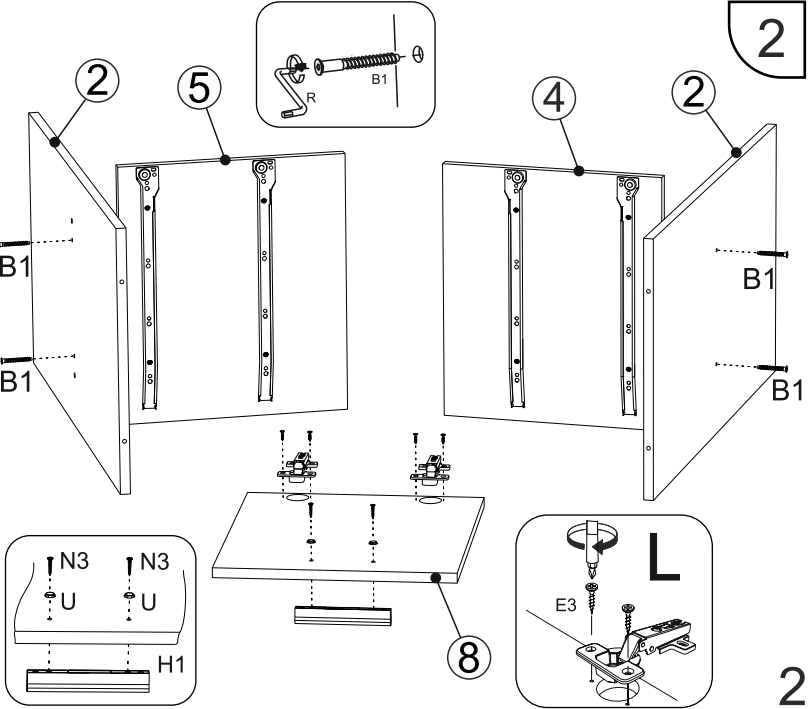
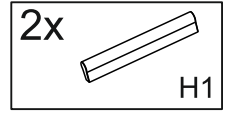
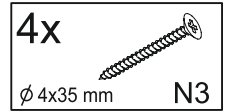
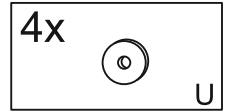
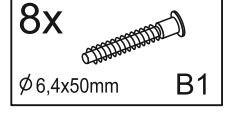
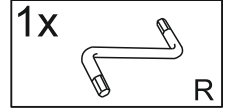
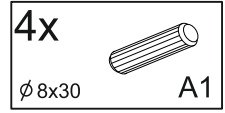

2

3

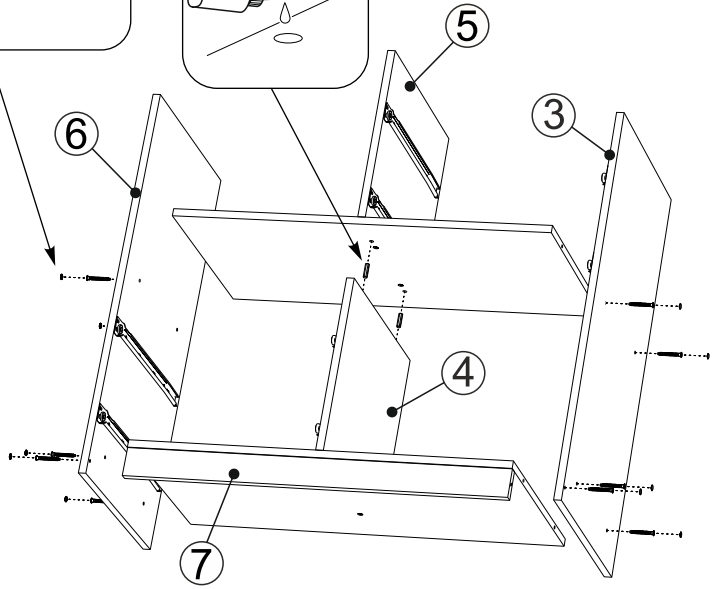
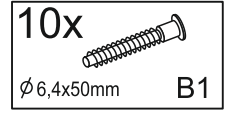
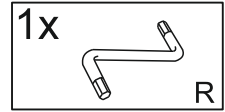
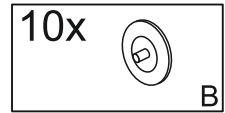
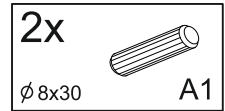
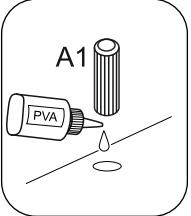
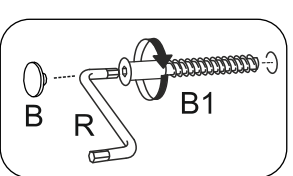

# “Commode-2+4” “Комод-2+4”

5

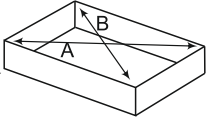
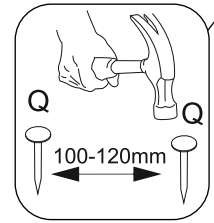

A=B

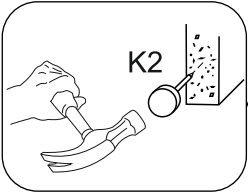
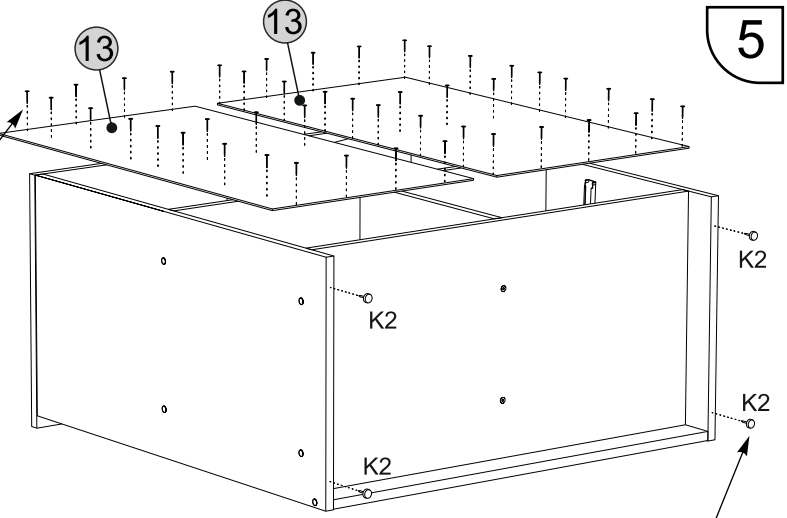
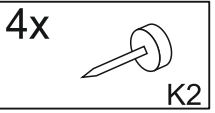

4

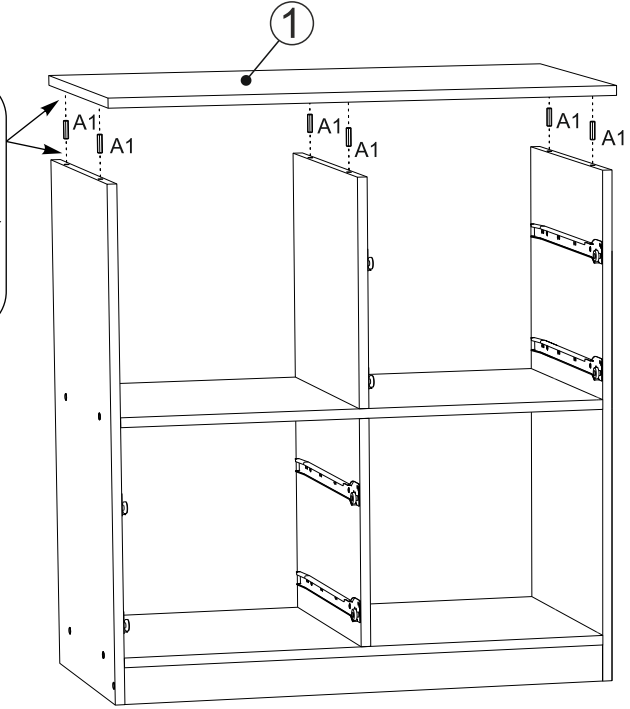
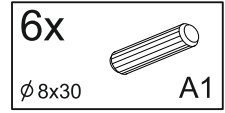
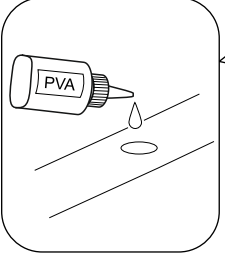

6

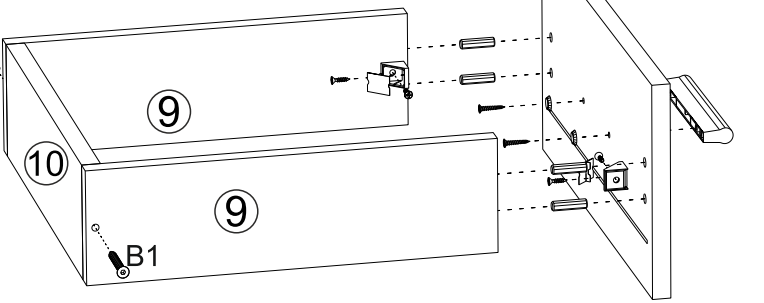
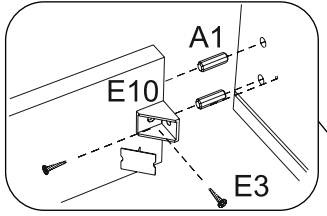
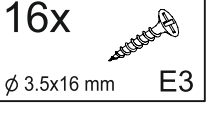
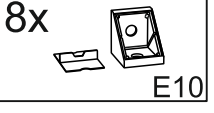
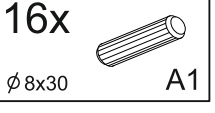
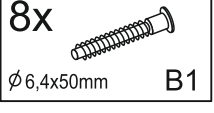
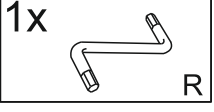
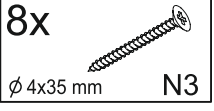
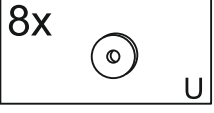
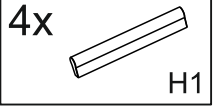

x4

3

7

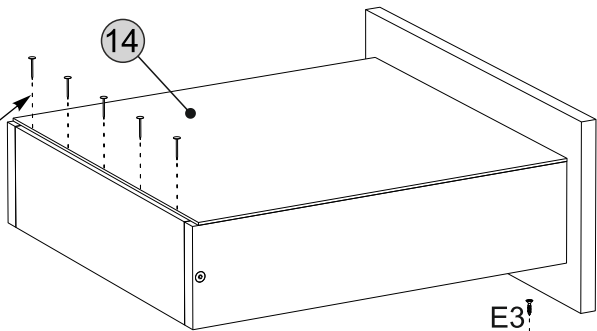
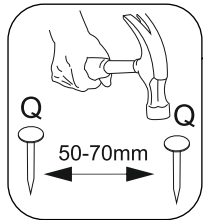

“Commode-2+4”  
“Комод-2+4”

x4

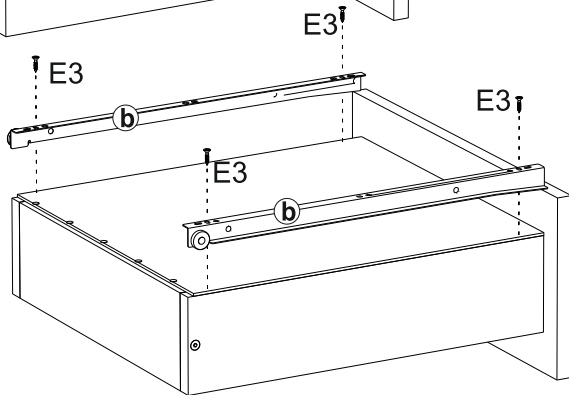
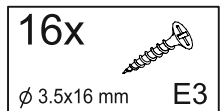
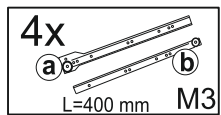

8

