

Plastic tubing, standard O.D.

FESTO



Festo Core Range
Solves the majority of your automation tasks

With the Festo Core Range, we have selected the most important products and functions from our broad product catalogue, and added the quickest delivery.

Worldwide: Quickest delivery – wherever, whenever
Simply good: Expected high Festo quality
Fast: Easy and fast to select

The Core Range offers you the best value for your automation tasks.

Just look
for the
star!

Key features

Application



The requirements for pressure, temperature, flexibility and environmental influences differ from one industry sector to the next. Users frequently underestimate the risks: around 90% of all cases of damage can be traced back to the wrong choice of tubing or tubing materials. This doesn't only result in energy losses, but also in machine downtimes. It is therefore really important to find a reliable and cost-effective product that prevents the tubing getting damaged during operation.

Summary of tubing/fitting combinations

Applications	Tubing	Fitting	Description
Standard	PUN-H	QS	Maximum flexibility in standard applications thanks to an extremely wide range of options for combining the different types.
	PAN	QS	Meets all requirements, even for standard applications with increased pressure and temperature ranges.
	PEN	QS	Suitable for a wide range of tasks and attractively priced. Can be widely used thanks to materials with good resistance, easy to install. High level of abrasion resistance in dynamic applications (e.g. in energy chains).
High pressures	PAN-MF	NPQM	The tubing meets DIN standard 73378: ideal for use in mobile pneumatics. Suitable for increased temperature ranges combined with high pressure ranges.
	PAN-R	NPQH	Powerful in pressure ranges up to 20 bar, for example in applications with the pressure booster DPA.
	PUN-H-SF	NPQR	For applications with increased requirements in terms of robustness, flexibility and pressure resistance. The tubing has maximum flexibility and is resistant to kinking and hydrolysis. The combination is suitable for applications with a high moisture content.
Chemical-resistant, hydrolysis-resistant	PLN	NPQP	Resistant to cleaning agents. Easy-to-clean and economical combination, made from material listed for use in the food zone. Can be used instead of the combination with stainless steel fittings.
	PUN-H	NPCK	Hydrolysis-resistant and suitable for water applications. Corrosion-resistant and made from material listed for use in the food zone.
	PUN-H-F	NPQR	Food-safe to Regulation (EC) No. 1935/2004 and FDA-listed materials. Can be used in the food and packaging industry in combination with fittings NPQR or NPQH. The tubing is hydrolysis-resistant and is suitable for water applications. Extremely flexible and thus easy to install.
	PFAN/PTFEN	NPQH	For high temperatures up to 150°C. Resistant to cleaning agents and made from material listed for use in the food zone.
	PFAN/PTFEN	NPCK	Easy to clean thanks to the union nut's edge-free design. Maximum corrosion resistance (CRC 4), highly resistant to aggressive acids and alkalis, made from material listed for use in the food zone. Suitable for a wide range of media.
PFAN	NPQR	Food-safe to Regulation (EC) 1935/2004 and made from FDA-listed material. For high temperatures up to 150°C. Pressure range up to 1.5 MPa. Maximum corrosion resistance (CRC 4).	
Antistatic	PUN-CM	NPQM	Antistatic tubing plus solid metal fitting: maximum protection for electrical and electronic components.
Flame-retardant	PUN-VO	NPQM	Very safe in areas where there is a risk of fire thanks to flame-retardant properties.
Resistant to welding spatter	PUN-VO-C	NPQH	Ideal in the vicinity of welding spatter and safe thanks to an increased tubing wall thickness for all diameters.
	PAN-VO	QS-VO	Safe even in the vicinity of welding spatter thanks to double-walled tubing with special fitting.
Battery production	PUN-H	NPQE-F1A ¹⁾	Suitable in battery production areas, ideal in combination with push-in connector NPQE-F1A.

1) F1A = Free of copper, zinc and nickel

Note

Ambient conditions and the medium to be transported can have a considerable effect on the service life of plastic tubing. Based on experience, Festo recommends the following time specifications for using plastic tubing in general and in safety-related applications:

- For general applications, a minimum service life of 10 years can be expected.
- We recommend that for safety-related applications the tubing is inspected regularly, at least every 12 months.
- For applications that have an effect on the material, inspections must be carried out at suitable intervals. We recommend that the interval between inspections should be no more than 6 months, at most half of the period in which failures can occur.

Technical data

Note

Tubing that is too long, diameters that are too small, and bending radii that are too small result in flow rate losses. One of the most important rules when selecting tubing is therefore that it should be as long as necessary and as short as possible. Make sure, therefore, that in practice tubing is loosely installed and is not stretched.

Tools for bundling tubing or for avoiding bending/pinching the tubing are available as accessories:

- Tubing strap PB
- Spiral tubing binder PKB
- Tubing support NPAW
- Tubing support PKS
- Multi-tube holder KK

Other accessories include connecting tools for tubing:

- Pipe and tubing cutter ZRS
- Tubing cutter PAN-VOS for flame-retardant plastic tubing PAN-VO
- Connecting pliers ZMS/disconnecting pliers ZDS for connecting/disconnecting the plastic tubing and barbed fitting

Suitability for contact with food



Tubing PFAN and PUN-H-F are suitable for contact with food. They have the necessary declaration of conformity in accordance with EU Regulation (EC) No. 1935/2004.

Measurement method

Flow-relevant bending radius R_d

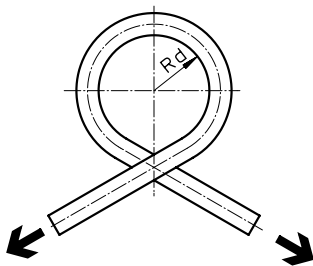

The tube is bent in the direction of its own curve until the tubing outer diameter is flattened by 5%. R_d is then calculated mathematically. The flow rate is not reduced until R_d is reached.

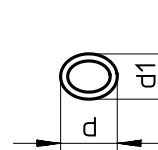

Cross-section flattened by bending the tube.

d = non-deformed tubing O.D.

d_1 = deformed tubing O.D.

Minimum bending radius R_{min}

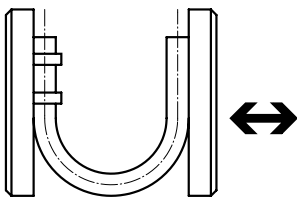

The tubing fixed to the base plate is bent until the deformation results in a kink. The measured value is the minimum bending radius R_{min} . This R_{min} results in significant reductions in the flow rate.

Product range overview

Type	Material	O.D. [mm]	Colour														
			Silver	Blue	Translucent blue	Black	Translucent black	Yellow	Translucent yellow	Green	Translucent green	Red	Translucent red	Brown	White	Natural	Blue/black
PUN	Polyurethane	3, 4, 6, 8, 10, 12, 14, 16	■	■	-	■	-	■	-	■	-	■	-	(■) ¹⁾	(■) ¹⁾	-	-
PUN-DUO	Polyurethane	4, 6, 8, 10	■	-	-	-	-	-	-	-	-	-	-	-	-	-	■
PUN-CM	Polyurethane	4, 6, 8, 10, 12, (14) ¹⁾	-	-	-	■	-	-	-	-	-	-	-	-	-	-	-
PUN-H	Polyurethane	2	-	-	-	■	-	-	-	-	-	-	■	-	-	-	■
		3, 4, 6, 8, 10, 12, 14, 16	■	■	■	■	■	■	■	■	■	■	■	■	(■) ¹⁾	(■) ¹⁾	■
PUN-H-DUO	Polyurethane	4, 6, 8, 10	-	-	-	-	-	-	-	-	-	-	-	-	-	-	■
PUN-H-F	Polyurethane	4, 6, 8, 10, 12, 16	-	■	■	■	-	■	-	■	-	■	-	-	-	■	-
		14	-	■	-	■	-	-	-	-	-	■	-	-	-	■	-
PUN-H-SF	Polyurethane	4, 6, 8, 10, 12, 14, 16, 18, 22, 25	-	■	-	■	-	-	-	-	-	-	-	-	-	-	-
PUN-VO	Polyurethane	6, 8, 10, 16	-	■	-	■	-	■	-	■	-	■	-	■	■	-	-
PUN-VO-C	Polyurethane	4, 6, 8, 10, 12, 14, 16	-	■	-	■	-	■	-	■	-	■	-	■	■	-	-
PAN	Polyamide	4, 6, 8, 10, 12, 14, 16	■	■	-	■	-	■	-	■	-	■	-	(■) ¹⁾	(■) ¹⁾	■	-
PAN-R	Polyamide	4, 6, 8, 10, 12, (14) ¹⁾ , 16	■	(■) ¹⁾	-	(■) ¹⁾	-	(■) ¹⁾	-	(■) ¹⁾	-	(■) ¹⁾	-	(■) ¹⁾	(■) ¹⁾	(■) ¹⁾	-
		22, 28	-	-	-	■	-	-	-	-	-	-	-	-	-	-	-
PAN-MF	Polyamide	4, 6, 8, 10, 12, 14, 16	(■) ¹⁾	(■) ¹⁾	-	■	-	(■) ¹⁾	-	(■) ¹⁾	-	(■) ¹⁾	-	(■) ¹⁾	(■) ¹⁾	(■) ¹⁾	-
PAN-VO	Polyamide	4, 6, 8, 10, 12	-	■	-	■	-	■	-	■	-	■	-	-	■	-	-
PFAN	Perfluoroalkoxy alkane	3, 4, 6, 8, 10, 12	-	-	-	-	-	-	-	-	-	-	-	-	-	■	-
PTFEN	Polytetrafluoroethylene	4, 6, 8, 10, 12, 14, 16	-	-	-	-	-	-	-	-	-	-	-	-	-	■	-
PEN	Polyethylene	4, 6, 8, 10, 12, 14, 16	■	■	-	■	-	■	-	■	-	■	-	(■) ¹⁾	(■) ¹⁾	■	-
PLN	Polyethylene	4, 6, 8, 10, 12, 14, 16	■	■	-	■	-	(■) ¹⁾	-	(■) ¹⁾	-	■	-	(■) ¹⁾	(■) ¹⁾	■	-

1) Please observe the note below.

 Note

Product options in brackets can only be ordered using the modular product system.

Please observe the minimum order quantity for tubing with O.D. ≤ 8 mm is 3000 m and for tubing with O.D. > 8 mm. it is 1500 m.

There is a modular product system for plastic tubing:

- PUN → page 36
- PAN → page 50
- PEN → page 61
- PLN → page 65

Product range overview

Type	Operating medium						Material fire test	Antistatic	Halogen-free	Contact with electric cables	Suitable for energy chains	Approved by the German Technical Control Board (TÜV)	Maritime classification	Resistance				Flexible	Shore hardness ⁸⁾	Tolerance for packaging length	→ Page/Internet
	Compressed air, vacuum	Water	Mineral oil	Oxygen	Food-safe ⁹⁾	Food-safe ¹⁰⁾								Chemicals	Microbes	UV radiation	Hydrolysis				
PUN	■	-	-	-	-	-	UL94 HB	-	■	■ ⁷⁾	■	■	-	-	-	++ ⁴⁾	+	+++	D 52 ±3	±1%	8
PUN-DUO	■	-	-	-	-	-	UL94 HB	-	■	■ ⁷⁾	■	■	-	-	-	+	+	++	D 52 ±3		11
PUN-CM	■	-	-	-	-	-	-	■	■	■	■	-	-	+	++	++	++	++	D 52 ±3		14
PUN-H	■	-	-	-	-	-	-	-	■	■	■	-	-	+	++	++ ⁴⁾	++	+++	D 52 ±3		16
	■	■	-	-	■	-	UL94 HB	-	■	■	■	■	-	+	++	++ ⁴⁾	++	+++	D 52 ±3		17
PUN-H-DUO	■	■	-	-	■	-	UL94 HB	-	■	■	■	■	-	+	++	+	++	++	D 52 ±3		22
PUN-H-F	■	■	-	■	-	■	UL94 HB	-	■	■	■	■	-	+	++	++ ⁴⁾	++	++	D 52 ±3		25
	■	■	-	■	-	■	UL94 HB	-	■	■	■	■	-	+	++	++ ⁴⁾	++	++	D 52 ±3		
PUN-H-SF	■	■	-	-	■	-	UL94 HB	-	■	■	■	-	-	+	++	++ ⁴⁾	++	+++	D 54 +/-3		27
PUN-VO	■	■	-	-	-	-	UL94 VO...V2	-	■	■	■	■	-	+	++	++ ⁴⁾	++	++	D 54 ±3		31
PUN-VO-C	■	■	-	-	-	-	UL94 VO...V2	-	■	■	■	■	-	+	++	++ ⁴⁾	++	++	D 54 ±3		33
PAN	■	-	-	-	-	-	-	-	■	■	■	■	■ ³⁾	+	++	+	++	++	D 55 ±3		38
PAN-R	■	-	-	-	-	-	-	-	■	■	■	■	-	+	++	+	++	+	D 62 ±3		42
	■	-	-	-	-	-	-	-	■	■	■	■	-	+	++	+	++	+	D 62 ±3		43
PAN-MF	■	-	■ ²⁾	-	-	-	-	-	■	■	■	-	-	+	++	+	++	+	D 65 ±3		45
PAN-VO	■	■	■	-	-	-	UL94 V0	-	-	■	■	-	-	+	++	++	++	++	A 72 ±4 ⁵⁾ D 57 ±3 ⁶⁾	48	
PFAN	■	■	-	-	■	■	UL94 V0	-	-	■	-	■	-	+++	++	++	+++	+	D 60 +5	52	
PTFEN	■	-	-	-	■	-	UL94 V0	-	-	■	-	-	-	+++	++	++	+++	+	D 55 ±5	55	
PEN	■	■	-	-	-	-	-	-	■	■	■	■	-	++	++	++ ⁴⁾	+++	++	D 52 ±3	58	
PLN	■	■	-	-	■	-	-	-	■	■	-	■	-	++	++	++ ⁴⁾	+++	+	D 59 ±3	63	

2) As a precaution, please check the operating medium with Festo.

3) Applies to the colours silver and natural

4) Applies to the colour black

5) Outside tubing

6) Inside tubing

7) Cables containing organophosphates may damage PUN tubing under unfavourable conditions.

8) Values are determined using test panels. Values determined using tubing may vary.

9) See the supplementary material information

10) See the declaration of conformity

■ Criterion met

- Not suitable

+++ Highly suitable

++ Suitable

+ Limited suitability (on request)

Recommended tubing/fitting combinations

Fitting	Tubing type																
	PUN	PUN-DUO	PUN-CM	PUN-H	PUN-H-DUO	PUN-H-F	PUN-H-SF	PUN-VO	PUN-VO-C	PAN	PAN-R	PAN-MF	PAN-VO	PEN	PLN	PFAN	PTFEN
Fitting CK ¹⁾	++	++	+	++	++	++	-	++	-	++	-	-	-	++	++	++	++
Fitting CN ²⁾	++	++	+	-	-	-	-	+	-	++	-	-	-	++	+	++	++
Fitting QS ³⁾	+++	+++	+	+++	+++	++	++	+	+	+++	++	++	+	+++	++	++	++
Fitting NPQH ⁴⁾	++	++	++	+++	+++	+++	+++	++	+++	++	+++	++	+	++	++	+++	+++
Fitting CRQS ⁵⁾	++	++	+	++	++	+++	++	++	++	++	++	++	+	++	++	+++	+++
Fitting NPQP ⁶⁾	++	++	+	++	++	+++	++	+	+	++	++	++	+	++	+++	+++	+++
Fitting NPKA ⁷⁾	++	++	+	+++	++	+++	++	+	-	++	++	-	-	++	++	++	++
Fitting NPCK ⁸⁾	++	++	++	++	++	+++	-	++	-	++	-	-	-	++	++	+++	+++
Fitting CQ ⁹⁾	-	-	-	-	-	-	-	-	-	-	++	-	-	-	-	-	-
Fitting QS-VO ¹⁰⁾	+	+	+	+	+	+	+	+	+	+	+	+	+++	+	++	+	+
Fitting NPQM ¹¹⁾	++	++	+++	++	++	++	++	+++	++	++	++	++	+	+++	++	++	++
Fitting NPQR ¹²⁾	++	++	++	+++	+++	+++	+++	++	++	++	++	++	+	++	+++	+++	+++

+++ Recommended tubing/fitting combination

++ Well suited

+ Limited suitability due to:

- Tubing PLN with fitting CN provides little flexibility

- No conductive contact with PUN-CM

- Incompatible characteristic "resistance to welding spatter" with PUN-VO / PUN-VO-C

- Sub-optimal combination with regard to welding spatter resistance when insulation is removed from double-sheathed tubing PAN-VO

Note: Fitting QS-VO is specially designed for tubing PAN-VO with the insulation removed using tubing cutter PAN-VOS.

With other fittings, there is a gap near the releasing sleeve and the protective function against welding spatter is lost.

There is also an increased risk of the tubing kinking in this area.

However, this risk of kinking can be prevented by ensuring large bending radii when installing the tubing.

- Not suitable

1) For tubing size 4 to 8

2) For tubing size 3 to 8

3) For tubing size 2 to 12, 16 and 22

4) For tubing size 4 to 14

5) For tubing size 4 to 12; 16

6) For tubing size 4 to 12

7) For tubing size 6

8) For tubing size 4 to 10

9) For tubing size 22 and 28 (22 also possible with QS)

10) For tubing size 4 to 12

11) For tubing size 3 to 14

12) For tubing size 4 to 16

Note

Greater force is required when assembling the fittings CK/CN. Expanding the tubing ends using a tapered mandrel makes pushing them on easier.

Type codes

001	Series
PUN	Plastic tubing, polyurethane

002	Pipe/tubing O.D. x wall thickness
3x0,5	3x0.5 mm
4x0,75	4x0.75 mm
6x1	6x1 mm
8x1,25	8x1.25 mm
10x1,5	10x1.5 mm
12x2	12x2 mm
14x2	14x2 mm
16x2,5	16x2.5 mm

003	Tubing type
	Standard
DUO	DUO pneumatic tubing

004	Colour
SW	Black
BL	Blue
SI	Silver
RT	Red
GN	Green
GE	Yellow
BS	Blue/black

005	Packaging unit [m]
	Standard
100	100 m
200	200 m
300	300 m
400	400 m
500	500 m

Datasheet

Plastic tubing PUN

Highly flexible plastic tubing

Material: Polyurethane

Note

The plastic tubing can only be installed in contact with cables if the sheathing is free from phosphoric acid esters. Failure to observe this can result in damage to the plastic tubing.



Operating and environmental conditions

Type		PUN-3	PUN-4	PUN-6	PUN-8	PUN-10	PUN-12	PUN-14	PUN-16
O.D.	[mm]	3	4	6	8	10	12	14	16
Pneumatic connection									
For push-in connector	[mm]	3	4	6	8	10	12	14	16
For barbed connector	[mm]	2	3	4	6	–	–	–	–
For barbed connector with union nut	[mm]	–	3	4	6	–	–	–	–
Temperature-dependent operating pressure	[MPa]	–0.095 ... +1 → graph							
	[bar]	–0.95 ... +10							
	[psi]	–13,775 ... +145							
Operating pressure for full temperature range	[MPa]	–0.095 ... +0.7							
	[bar]	–0.95 ... +7							
	[psi]	–13,775 ... +101.5							
Operating medium		Compressed air to ISO 8573-1:2010 [7:--:–]							
Ambient temperature	[°C]	–35 ... +60							
Material fire test		UL94 HB							
Certification		German Technical Control Board (TÜV)							
Certificate-issuing authority		B 013277 0506 00							
Tubing characteristics		Suitable for energy chains							

Operating pressure p as a function of temperature t

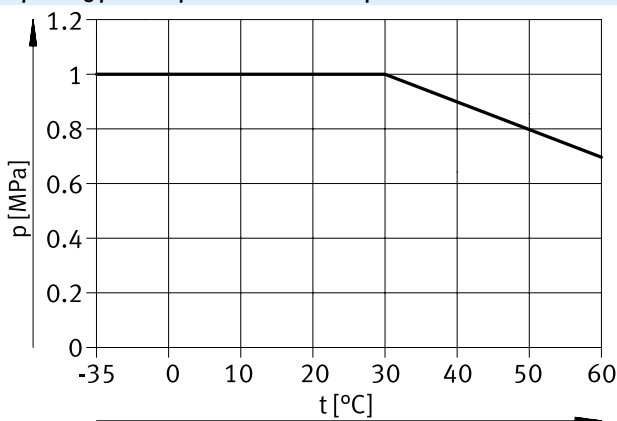

Materials

Shore hardness	D 52 ±3
Material of tubing	TPE-U(PU)
Note on materials	RoHS-compliant
Application information	The plastic tubing can only be installed in contact with cables if the sheathing is free from phosphoric acid esters.
	TPE-U, ester-based
LABS (PWIS) conformity	VDMA24364-B2-L

Datasheet

Dimensions – Reel

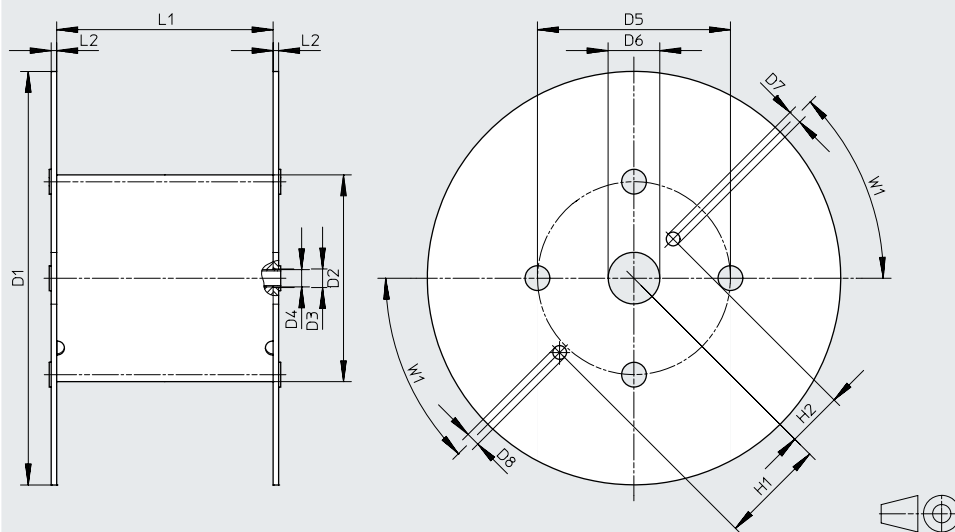

Type	D1 ø	D2 ø	D3 ø	D4 ø	D5 ø	D6 ø	D7 ø	D8 ø	H1	H2	L1	L2	W1
For PUN-3x0.5-...-500	545	246	21	20	216	75	20	20	152.5	80.5	128	8	45°
For PUN-4x0.75-...-500	545	246	21	20	216	75	20	20	152.5	80.5	128	8	45°
For PUN-6x1-...-500	600	310	21	20	280	75	20	20	152.5	80.5	114	8	45°
For PUN-8x1.25-...-400	545	310	21	20	280	75	20	20	152.5	80.5	254	8	45°
For PUN-10x1.5-...-300	600	310	21	20	280	75	20	20	152.5	80.5	254	8	45°
For PUN-12x2-...-200	600	310	21	20	280	75	20	20	152.5	80.5	254	8	45°
For PUN-16x2.5-...-100	545	310	21	20	280	75	20	20	152.5	80.5	254	8	45°

Dimensions and ordering data

O.D. [mm]	I.D. [mm]	Min. bending radius [mm]	Flow-relevant bending radius [mm]	Weight [kg/m]	Colour	Part no.	Type	PJ ¹⁾ [m]
3	2.1	9	12	0.0044	Silver	152583	PUN-3x0.5-SI	50
					Silver	525738	PUN-3x0.5-SI-500	500
					Blue	159660	PUN-3x0.5-BL	50
					Blue	525745	PUN-3x0.5-BL-500	500
					Black	159661	PUN-3x0.5-SW	50
					Black	553936	PUN-3x0.5-SW-500	500
					Yellow	178416	PUN-3x0.5-GE	50
					Green	178423	PUN-3x0.5-GN	50
					Red	178409	PUN-3x0.5-RT	50
4	2.6	8	17	0.0089	Silver	152584	PUN-4x0.75-SI	50
					Silver	525739	PUN-4x0.75-SI-500	500
					Blue	159662	PUN-4x0.75-BL	50
					Blue	525746	PUN-4x0.75-BL-500	500
					Black	159663	PUN-4x0.75-SW	50
					Black	553937	PUN-4x0.75-SW-500	500
					Yellow	178417	PUN-4x0.75-GE	50
					Green	178424	PUN-4x0.75-GN	50
					Red	178410	PUN-4x0.75-RT	50

1) Packaging unit

Datasheet

Dimensions and ordering data								
O.D.	I.D.	Min. bending radius	Flow-relevant bending radius	Weight	Colour	Part no.	Type	PU ¹⁾
[mm]	[mm]	[mm]	[mm]	[kg/m]				[m]
6	4.0	16	26.5	0.0192	Silver	152586	PUN-6x1-SI	50
					Silver	525740	PUN-6x1-SI-500	500
					Blue	159664	PUN-6x1-BL	50
					Blue	525747	PUN-6x1-BL-500	500
					Black	159665	PUN-6x1-SW	50
					Black	553938	PUN-6x1-SW-500	500
					Yellow	178418	PUN-6x1-GE	50
					Green	178425	PUN-6x1-GN	50
					Red	178411	PUN-6x1-RT	50
8	5.7	24	37	0.0302	Silver	152587	PUN-8x1.25-SI	50
					Silver	525741	PUN-8x1.25-SI-400	400
					Blue	159666	PUN-8x1.25-BL	50
					Blue	525748	PUN-8x1.25-BL-400	400
					Black	159667	PUN-8x1.25-SW	50
					Black	553939	PUN-8x1.25-SW-400	400
					Yellow	178419	PUN-8x1.25-GE	50
					Green	178426	PUN-8x1.25-GN	50
					Red	178412	PUN-8x1.25-RT	50
10	7.0	28	54	0.0489	Silver	152588	PUN-10x1.5-SI	50
					Silver	525742	PUN-10x1.5-SI-300	300
					Blue	159668	PUN-10x1.5-BL	50
					Blue	525749	PUN-10x1.5-BL-300	300
					Black	159669	PUN-10x1.5-SW	50
					Black	553940	PUN-10x1.5-SW-300	300
					Yellow	178420	PUN-10x1.5-GE	50
					Green	178427	PUN-10x1.5-GN	50
					Red	178413	PUN-10x1.5-RT	50
12	8.0	33	62	0.0767	Silver	152589	PUN-12x2-SI	50
					Silver	525743	PUN-12x2-SI-200	200
					Blue	159670	PUN-12x2-BL	50
					Blue	525750	PUN-12x2-BL-200	200
					Black	159671	PUN-12x2-SW	50
					Black	553941	PUN-12x2-SW-200	200
					Yellow	178421	PUN-12x2-GE	50
					Green	178428	PUN-12x2-GN	50
					Red	178414	PUN-12x2-RT	50
14	9.8	45	84	0.0949	Silver	570389	PUN-14x2-SI	50
					Blue	570390	PUN-14x2-BL	50
					Black	570391	PUN-14x2-SW	50
16	11.0	45	88	0.1294	Silver	152590	PUN-16x2.5-SI	50
					Silver	525744	PUN-16x2.5-SI-100	100
					Blue	159672	PUN-16x2.5-BL	50
					Blue	525751	PUN-16x2.5-BL-100	100
					Black	159673	PUN-16x2.5-SW	50
					Black	553942	PUN-16x2.5-SW-100	100
					Yellow	178422	PUN-16x2.5-GE	50
					Green	178429	PUN-16x2.5-GN	50
					Red	178415	PUN-16x2.5-RT	50

1) Packaging unit

Datasheet

DUO tubing PUN-DUO

Highly flexible paired plastic tubing that is characterised by excellent resistance to abrasion and kinking. Two lengths of tubing are fused together into a tubing pair. To install it, the tubing pair is separated as required at both ends.

Note

The plastic tubing can only be installed in contact with cables if the sheathing is free from phosphoric acid esters. Failure to observe this can result in damage to the plastic tubing.

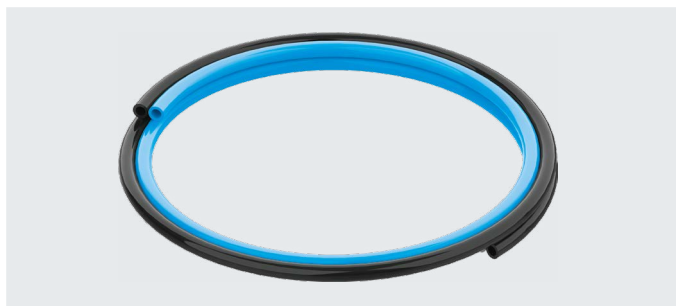

Material: Polyurethane

Operating and environmental conditions

Type	PUN-4-...-DUO	PUN-6-...-DUO	PUN-8-...-DUO	PUN-10-...-DUO
O.D. [mm]	4	6	8	10
Pneumatic connection				
For push-in connector [mm]	4	6	8	10
For barbed connector [mm]	3	4	6	–
For barbed connector with union nut [mm]	3	4	6	–
Temperature-dependent operating pressure	[MPa]	–0.095 ... +1 → graph		
	[bar]	–0.95 ... +10		
	[psi]	–13,775 ... +145		
Operating pressure for full temperature range	[MPa]	–0.095 ... +0.7		
	[bar]	–0.95 ... +7		
	[psi]	–13,775 ... +101.5		
Operating medium	Compressed air to ISO 8573-1:2010 [7:--]			
Ambient temperature [°C]	–35 ... +60			
Material fire test	UL94 HB			
Certification	German Technical Control Board (TÜV)			
Certificate-issuing authority	B 013277 0506 00			
Tubing characteristics	Suitable for energy chains			

Operating pressure p as a function of temperature t

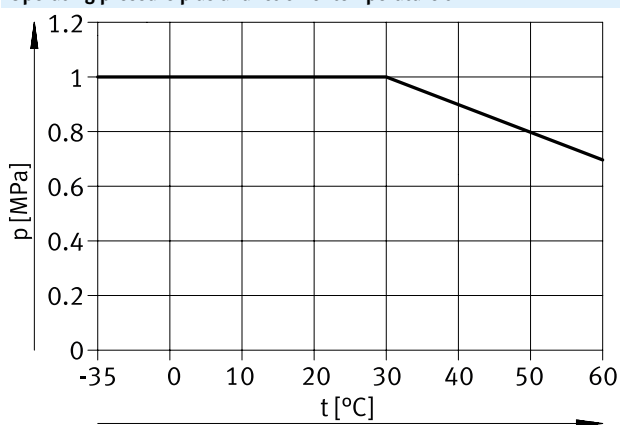

Datasheet

Materials

Shore hardness	D 52 ±3
Material of tubing	TPE-U(PU)
Note on materials	RoHS-compliant
Application information	The plastic tubing can only be installed in contact with cables if the sheathing is free from phosphoric acid esters. TPE-U, ester-based
LABS (PWIS) conformity	VDMA24364-B2-L

Dimensions and ordering data

O.D. [mm]	I.D. [mm]	Min. bending radius [mm]	Flow-relevant bending radius [mm]	Weight [kg/m]	Colour	Part no.	Type	PU ¹⁾ [m]
4	2.6	8	17	0.0178	Silver	152822	PUN-4x0.75-DUO-SI	50
					Blue/black	159674	PUN-4x0.75-DUO-BS	50
6	4	16	26.5	0.0384	Silver	152823	PUN-6x1-DUO-SI	50
					Blue/black	159675	PUN-6x1-DUO-BS	50
8	5.7	24	37	0.0604	Silver	152824	PUN-8x1.25-DUO-SI	50
					Blue/black	159676	PUN-8x1.25-DUO-BS	50
10	7	28	54	0.0978	Silver	152825	PUN-10x1.5-DUO-SI	50
					Blue/black	159677	PUN-10x1.5-DUO-BS	50

1) Packaging unit

Type codes

001	Series
PUN	Plastic tubing, polyurethane

002	Alternative material characteristic
CM	Antistatic

003	Tubing outside diameter
12	12 mm
4	4 mm
6	6 mm
8	8 mm
10	10 mm

004	Colour
SW	Black

Datasheet

Plastic tubing PUN-CM

Highly flexible plastic tubing, electrically conductive.

Material: Polyurethane



Operating and environmental conditions

Type	PUN-CM-4	PUN-CM-6	PUN-CM-8	PUN-CM-10	PUN-CM-12
O.D. [mm]	4	6	8	10	12
Pneumatic connection					
For push-in connector [mm]	4	6	8	10	12
Temperature-dependent operating pressure	-0.095 ... +1 → graph [MPa]				
	-0.95 ... +10 [bar]				
	-13.775 ... +145 [psi]				
Operating medium	Compressed air to ISO 8573-1:2010 [7:-:-]				
Ambient temperature [°C]	-35 ... +60				
Surface resistance [Ω]	10 ⁴ ... 10 ⁷				
Tubing characteristics	Suitable for energy chains				

Operating pressure p as a function of temperature t

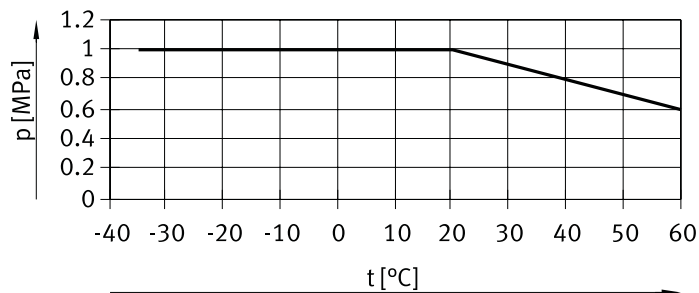

Materials

Shore hardness	D 52 ±3
Tubing	TPE-U(PU)
Note on materials	RoHS-compliant
LABS (PWIS) conformity	VDMA24364-B2-L

Dimensions and ordering data

O.D. [mm]	I.D. [mm]	Min. bending radius [mm]	Flow-relevant bending radius [mm]	Weight [kg/m]	Colour	Part no.	Type	PU ¹⁾ [m]
4	2.5	8	17	0.00993	Black	188882	PUN-CM-4-SW	50
6	4	14	28	0.02125		188883	PUN-CM-6-SW	50
8	5.5	20	37	0.03527		130816	PUN-CM-8-SW	50
10	7	30	60	0.05158		130817	PUN-CM-10-SW	50
12	8	30	70	0.08107		130818	PUN-CM-12-SW	50
14	9.8	41	80	0.095		Modular product system → 36		

1) Packaging unit

Type codes

001	Series
PUN	Plastic tubing, polyurethane

002	Alternative material characteristic
H	Hydrolysis-resistant

003	Pipe/tubing O.D. x wall thickness
2x0,4	2x0.4 mm
3x0,5	3x0.5 mm
4x0,75	4x0.75 mm
6x1	6x1 mm
8x1,25	8x1.25 mm
10x1,5	10x1.5 mm
12x2	12x2 mm
14x2	14x2 mm
16x2,5	16x2.5 mm

004	Tubing type
	Standard
DUO	DUO pneumatic tubing

005	Colour
NT	Natural
TBL	Translucent blue
SW	Black
BL	Blue
TSW	Translucent black
SI	Silver
RT	Red
TRT	Translucent red
GN	Green
TGN	Translucent green
GE	Yellow
TGE	Translucent yellow
BS	Blue/black

006	Packaging unit [m]
	Standard
100	100 m
200	200 m
300	300 m
400	400 m
500	500 m

Datasheet

Plastic tubing PUN-H

With O.D. 2 mm

Material: Polyurethane



Operating and environmental conditions

Type		PUN-H-2
O.D.	[mm]	2
Pneumatic connection		
For push-in connector	[mm]	2
Temperature-dependent operating pressure	[MPa]	-0.095 ... +1 → graph
	[bar]	-0.95 ... +10
	[psi]	-13.775 ... +145
Operating pressure for full temperature range	[MPa]	-0.095 ... +0.6
	[bar]	-0.95 ... +6
	[psi]	-13.775 ... +87
Operating medium		Compressed air to ISO 8573-1:2010 [7:--]
Ambient temperature	[°C]	-35 ... +60
Tubing characteristics		Suitable for energy chains

Operating pressure p as a function of temperature t

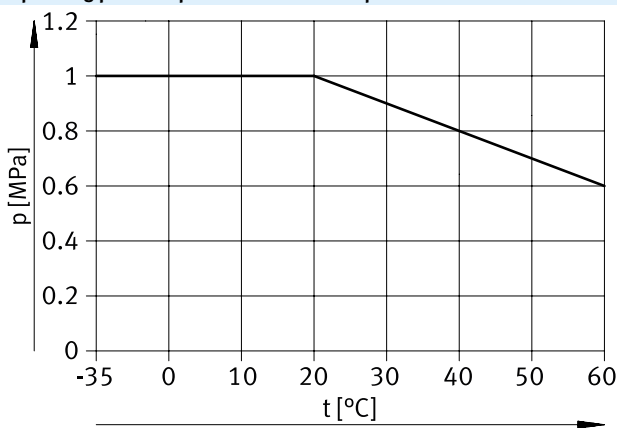

Materials

Shore hardness	D 52 ±3
Tubing	TPE-U(PU)
Note on materials	RoHS-compliant
LABS (PWIS) conformity	VDMA24364-B2-L
Application information	TPE-U, ether-based

Dimensions and ordering data

O.D.	I.D.	Min. bending radius	Flow-relevant bending radius	Weight	Colour	Part no.	Type	PU ¹⁾
[mm]	[mm]	[mm]	[mm]	[kg/m]				[m]
2	1.2	5	8	0.0024	Natural	133038	PUN-H-2x0.4-NT	50
					Black	133039	PUN-H-2x0.4-SW	50
					Red	133040	PUN-H-2x0.4-RT	50

1) Packaging unit

Datasheet

Plastic tubing PUN-H

With O.D. 3 ... 16 mm

Material: Polyurethane



Operating and environmental conditions

Type		PUN-H-3	PUN-H-4	PUN-H-6	PUN-H-8	PUN-H-10	PUN-H-12	PUN-H-14	PUN-H-16
O.D.	[mm]	3	4	6	8	10	12	14	16
Pneumatic connection									
	For push-in connector [mm]	3	4	6	8	10	12	14	16
	For barbed connector with union nut [mm]	–	3	4	6	–	–	–	–
Temperature-dependent operating pressure	[MPa]	–0.095 ... +1 → graph							
	[bar]	–0.95 ... +10							
	[psi]	–13,775 ... +145							
Operating pressure for full temperature range	[MPa]	–0.095 ... +0.6							
	[bar]	–0.95 ... +6							
	[psi]	–13,775 ... +87							
Operating medium		Compressed air to ISO 8573-1:2010 [7:-:-]							
		Water as per manufacturer's declaration ¹⁾²⁾							
LABS (PWIS) conformity		VDMA24364-B2-L							
Suitable for the production of lithium-ion batteries		Metals with more than 1% by mass of copper, zinc or nickel are excluded from use. Exceptions are nickel in steel, chemically nickel-plated surfaces, printed circuit boards, cables, electrical plug connectors and coils.							
Cleanroom class		Element installed statically, no meaningful evaluation possible according to ISO 14644-1							
Application information		TPE-U, ether-based							
Ambient temperature	[°C]	–35 ... +60							
Food-safe ²⁾		See supplementary material information							
Material fire test		UL94 HB							
Certification ²⁾		German Technical Control Board (TÜV)							
Certificate-issuing authority		B 013277 0506 00							
Tubing characteristics		Suitable for energy chains							

1) Applies only to the colours natural, blue, black, silver, red, green, yellow

2) More information: www.festo.com/catalogue/pun-h → Support/Downloads.

Operating pressure p as a function of temperature t

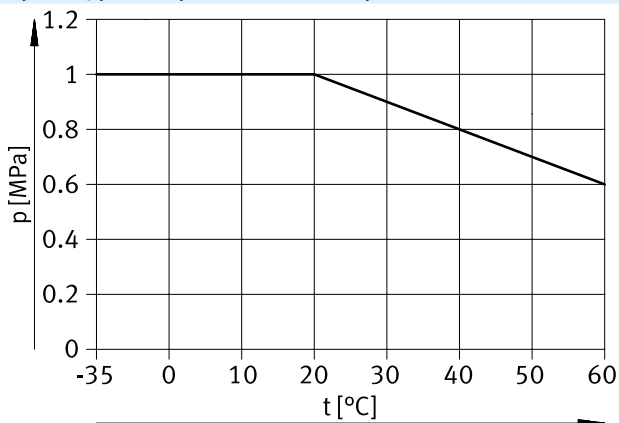

Operating pressure p as a function of temperature t (medium: water)

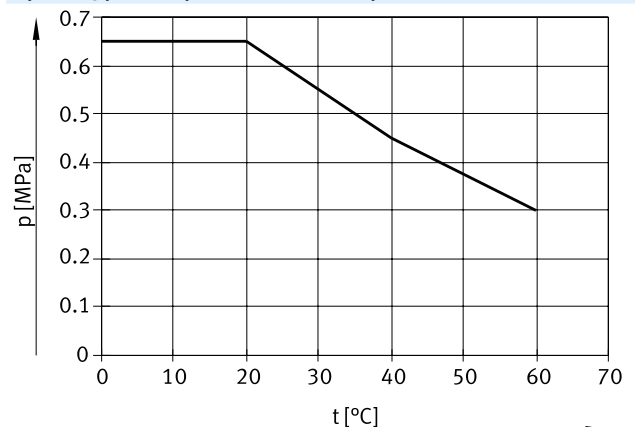

Datasheet

Materials

Shore hardness	D 52 ±3
Tubing	TPE-U(PU)
Note on materials	RoHS-compliant
LABS (PWIS) conformity	VDMA24364-B2-L
Suitable for the production of lithium-ion batteries	Metals with more than 1% by mass of copper, zinc or nickel are excluded from use. Exceptions are nickel in steel, chemically nickel-plated surfaces, printed circuit boards, cables, electrical plug connectors and coils.
Cleanroom class	Element installed statically, no meaningful evaluation possible according to ISO 14644-1
Application information	TPE-U, ether-based

Dimensions – Reel

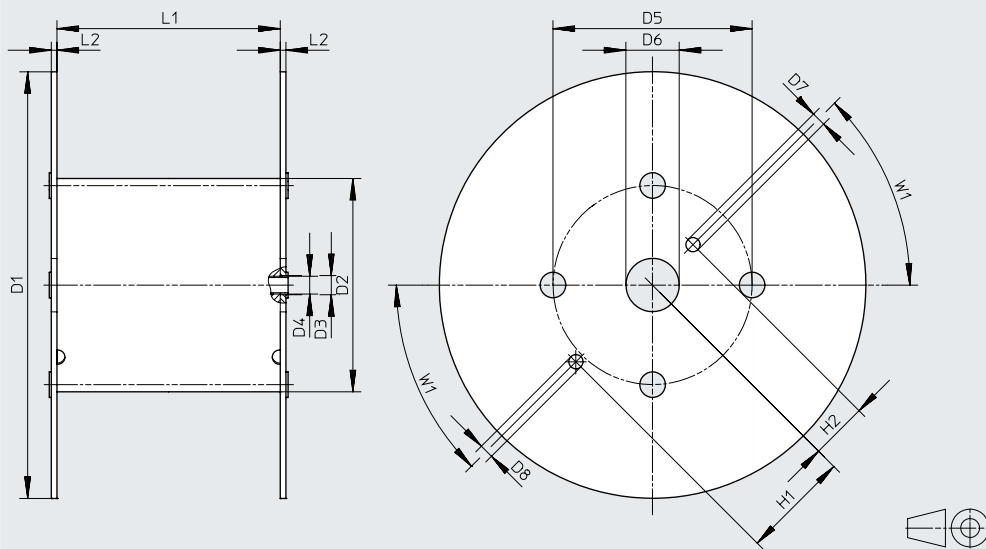

Type	D1 ø	D2 ø	D3 ø	D4 ø	D5 ø	D6 ø	D7 ø	D8 ø	H1	H2	L1	L2	W1
For PUN-H-3x0.5-...-500	545	246	21	20	216	75	20	20	152.5	80.5	128	8	45°
For PUN-H-4x0.75-...-500	545	246	21	20	216	75	20	20	152.5	80.5	128	8	45°
For PUN-H-6x1-...-500	545	246	21	20	216	75	20	20	152.5	80.5	128	8	45°
For PUN-H-8x1.25-...-400	545	310	21	20	280	75	20	20	152.5	80.5	254	8	45°
For PUN-H-10x1.5-...-300	600	310	21	20	280	75	20	20	152.5	80.5	254	8	45°
For PUN-H-12x2-...-200	600	310	21	20	280	75	20	20	152.5	80.5	254	8	45°
For PUN-H-16x2.5-...-100	545	310	21	20	280	75	20	20	152.5	80.5	254	8	45°

Dimensions and ordering data

O.D. [mm]	I.D. [mm]	Min. bending radius [mm]	Flow-relevant bending radius [mm]	Weight [kg/m]	Colour	Part no.	Type	PU ¹⁾ [m]
3	2.1	6	12	0.0042	Natural	197375	PUN-H-3x0.5-NT	50
					Natural	558263	PUN-H-3x0.5-NT-500	500
					Blue	197382	PUN-H-3x0.5-BL	50
					Blue	558256	PUN-H-3x0.5-BL-500	500
					Black	197389	PUN-H-3x0.5-SW	50
					Black	558249	PUN-H-3x0.5-SW-500	500
					Silver	558277	PUN-H-3x0.5-SI	50
					Silver	558270	PUN-H-3x0.5-SI-500	500
					Red	558284	PUN-H-3x0.5-RT	50
					Green	558291	PUN-H-3x0.5-GN	50
Yellow	558298	PUN-H-3x0.5-GE	50					

1) Packaging unit

Datasheet

★ Core Range

Dimensions and ordering data								
O.D. [mm]	I.D. [mm]	Min. bending radius [mm]	Flow-relevant bending radius [mm]	Weight [kg/m]	Colour	Part no.	Type	PU ¹⁾ [m]
4	2.6	8	16	0.0085	Natural	★ 197376	PUN-H-4x0.75-NT	50
					Natural	★ 558264	PUN-H-4x0.75-NT-500	500
					Blue	★ 197383	PUN-H-4x0.75-BL	50
					Blue	★ 558257	PUN-H-4x0.75-BL-500	500
					Translucent blue	★ 8048671	PUN-H-4x0.75-TBL	50
					Translucent blue	★ 8048672	PUN-H-4x0.75-TBL-500	500
					Black	★ 197390	PUN-H-4x0.75-SW	50
					Black	★ 558250	PUN-H-4x0.75-SW-500	500
					Translucent black	★ 8048673	PUN-H-4x0.75-TSW	50
					Translucent black	★ 8048674	PUN-H-4x0.75-TSW-500	500
					Silver	★ 558278	PUN-H-4x0.75-SI	50
					Silver	★ 558271	PUN-H-4x0.75-SI-500	500
					Red	558285	PUN-H-4x0.75-RT	50
					Translucent red	8048675	PUN-H-4x0.75-TRT	50
					Translucent red	8048676	PUN-H-4x0.75-TRT-500	500
					Green	558292	PUN-H-4x0.75-GN	50
					Translucent green	8048677	PUN-H-4x0.75-TGN	50
					Translucent green	8048678	PUN-H-4x0.75-TGN-500	500
					Yellow	558299	PUN-H-4x0.75-GE	50
					Translucent yellow	8048679	PUN-H-4x0.75-TGE	50
Translucent yellow	8048680	PUN-H-4x0.75-TGE-500	500					
6	4	10	26	0.0183	Natural	★ 197377	PUN-H-6x1-NT	50
					Natural	★ 558265	PUN-H-6x1-NT-500	500
					Blue	★ 197384	PUN-H-6x1-BL	50
					Blue	★ 558258	PUN-H-6x1-BL-500	500
					Translucent blue	★ 8048681	PUN-H-6x1-TBL	50
					Translucent blue	★ 8048682	PUN-H-6x1-TBL-500	500
					Black	★ 197391	PUN-H-6x1-SW	50
					Black	★ 558251	PUN-H-6x1-SW-500	500
					Translucent black	★ 8048683	PUN-H-6x1-TSW	50
					Translucent black	★ 8048684	PUN-H-6x1-TSW-500	500
					Silver	★ 558279	PUN-H-6x1-SI	50
					Silver	★ 558272	PUN-H-6x1-SI-500	500
					Red	558286	PUN-H-6x1-RT	50
					Translucent red	8048685	PUN-H-6x1-TRT	50
					Translucent red	8048686	PUN-H-6x1-TRT-500	500
					Green	558293	PUN-H-6x1-GN	50
					Translucent green	8048687	PUN-H-6x1-TGN	50
					Translucent green	8048688	PUN-H-6x1-TGN-500	500
					Yellow	558300	PUN-H-6x1-GE	50
					Translucent yellow	8048689	PUN-H-6x1-TGE	50
Translucent yellow	8048690	PUN-H-6x1-TGE-500	500					

1) Packaging unit

Datasheet

★ Core Range

Dimensions and ordering data								
O.D. [mm]	I.D. [mm]	Min. bending radius [mm]	Flow-relevant bending radius [mm]	Weight [kg/m]	Colour	Part no.	Type	PU ¹⁾ [m]
8	5.7	21	37	0.0287	Natural	★ 197378	PUN-H-8x1.25-NT	50
					Natural	★ 558266	PUN-H-8x1.25-NT-400	400
					Blue	★ 197385	PUN-H-8x1.25-BL	50
					Blue	★ 558259	PUN-H-8x1.25-BL-400	400
					Translucent blue	★ 8048691	PUN-H-8x1.25-TBL	50
					Translucent blue	★ 8048692	PUN-H-8x1.25-TBL-400	400
					Black	★ 197392	PUN-H-8x1.25-SW	50
					Black	★ 558252	PUN-H-8x1.25-SW-400	400
					Translucent black	★ 8048693	PUN-H-8x1.25-TSW	50
					Translucent black	★ 8048694	PUN-H-8x1.25-TSW-400	400
					Silver	★ 558280	PUN-H-8x1.25-SI	50
					Silver	★ 558273	PUN-H-8x1.25-SI-400	400
					Red	558287	PUN-H-8x1.25-RT	50
					Translucent red	8048695	PUN-H-8x1.25-TRT	50
					Translucent red	8048696	PUN-H-8x1.25-TRT-400	400
					Green	558294	PUN-H-8x1.25-GN	50
					Translucent green	8048697	PUN-H-8x1.25-TGN	50
					Translucent green	8048698	PUN-H-8x1.25-TGN-400	400
					Yellow	558301	PUN-H-8x1.25-GE	50
					Translucent yellow	8048699	PUN-H-8x1.25-TGE	50
Translucent yellow	8048700	PUN-H-8x1.25-TGE-400	400					
10	7	28	52	0.0465	Natural	★ 197379	PUN-H-10x1.5-NT	50
					Natural	★ 558267	PUN-H-10x1.5-NT-300	300
					Blue	★ 197386	PUN-H-10x1.5-BL	50
					Blue	★ 558260	PUN-H-10x1.5-BL-300	300
					Translucent blue	★ 8048701	PUN-H-10x1.5-TBL	50
					Translucent blue	★ 8048702	PUN-H-10x1.5-TBL-300	300
					Black	★ 197393	PUN-H-10x1.5-SW	50
					Black	★ 558253	PUN-H-10x1.5-SW-300	300
					Translucent black	★ 8048703	PUN-H-10x1.5-TSW	50
					Translucent black	★ 8048704	PUN-H-10x1.5-TSW-300	300
					Silver	★ 558281	PUN-H-10x1.5-SI	50
					Silver	★ 558274	PUN-H-10x1.5-SI-300	300
					Red	558288	PUN-H-10x1.5-RT	50
					Translucent red	8048705	PUN-H-10x1.5-TRT	50
					Translucent red	8048706	PUN-H-10x1.5-TRT-300	300
					Green	558295	PUN-H-10x1.5-GN	50
					Translucent green	8048707	PUN-H-10x1.5-TGN	50
					Translucent green	8048708	PUN-H-10x1.5-TGN-300	300
					Yellow	558302	PUN-H-10x1.5-GE	50
					Translucent yellow	8048709	PUN-H-10x1.5-TGE	50
Translucent yellow	8048710	PUN-H-10x1.5-TGE-300	300					

1) Packaging unit

Datasheet

★ Core Range

Dimensions and ordering data								
O.D. [mm]	I.D. [mm]	Min. bending radius [mm]	Flow-relevant bending radius [mm]	Weight [kg/m]	Colour	Part no.	Type	PU ¹⁾ [m]
12	8	33	62	0.0729	Natural	★ 197380	PUN-H-12x2-NT	50
					Natural	★ 558268	PUN-H-12x2-NT-200	200
					Blue	★ 197387	PUN-H-12x2-BL	50
					Blue	★ 558261	PUN-H-12x2-BL-200	200
					Translucent blue	★ 8048711	PUN-H-12x2-TBL	50
					Translucent blue	★ 8048712	PUN-H-12x2-TBL-200	200
					Black	★ 197394	PUN-H-12x2-SW	50
					Black	★ 558254	PUN-H-12x2-SW-200	200
					Translucent black	★ 8048713	PUN-H-12x2-TSW	50
					Translucent black	★ 8048714	PUN-H-12x2-TSW-200	200
					Silver	★ 558282	PUN-H-12x2-SI	50
					Silver	★ 558275	PUN-H-12x2-SI-200	200
					Red	558289	PUN-H-12x2-RT	50
					Translucent red	8048715	PUN-H-12x2-TRT	50
					Translucent red	8048716	PUN-H-12x2-TRT-200	200
					Green	558296	PUN-H-12x2-GN	50
					Translucent green	8048717	PUN-H-12x2-TGN	50
					Translucent green	8048718	PUN-H-12x2-TGN-200	200
					Yellow	558303	PUN-H-12x2-GE	50
					Translucent yellow	8048719	PUN-H-12x2-TGE	50
Translucent yellow	8048720	PUN-H-12x2-TGE-200	200					
14	9.8	38	78	0.091	Natural	570388	PUN-H-14x2-NT	50
					Blue	570386	PUN-H-14x2-BL	50
					Black	570387	PUN-H-14x2-SW	50
16	11	38	88	0.123	Natural	197381	PUN-H-16x2.5-NT	50
					Natural	558269	PUN-H-16x2.5-NT-100	100
					Blue	197388	PUN-H-16x2.5-BL	50
					Blue	558262	PUN-H-16x2.5-BL-100	100
					Black	197395	PUN-H-16x2.5-SW	50
					Black	558255	PUN-H-16x2.5-SW-100	100
					Silver	558283	PUN-H-16x2.5-SI	50
					Silver	558276	PUN-H-16x2.5-SI-100	100
					Red	558290	PUN-H-16x2.5-RT	50
					Green	558297	PUN-H-16x2.5-GN	50
					Yellow	558304	PUN-H-16x2.5-GE	50

1) Packaging unit

Datasheet

DUO tubing PUN-H-DUO

Highly flexible paired plastic tubing that is characterised by excellent resistance to abrasion and kinking.

Two lengths of tubing are fused together into a tubing pair. To install it, the tubing pair is separated as required at both ends.

Material: Polyurethane

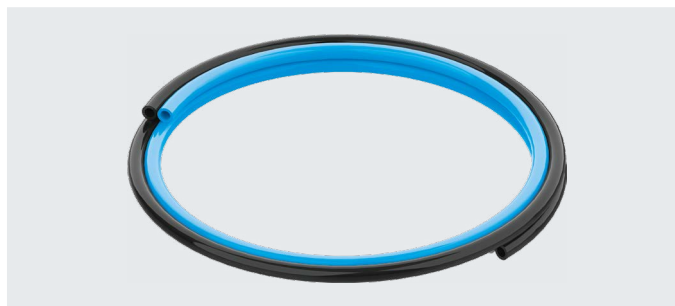

Operating and environmental conditions

Type	PUN-H-4-...-DUO	PUN-H-6-...-DUO	PUN-H-8-...-DUO	PUN-H-10-...-DUO	
O.D. [mm]	4	6	8	10	
Pneumatic connection					
For push-in connector [mm]	4	6	8	10	
For barbed connector with union nut [mm]	3	4	6	-	
Temperature-dependent operating pressure	[MPa]	-0.095 ... +1 → graph			
	[bar]	-0.95 ... +10			
	[psi]	-13,775 ... +145			
Operating pressure for full temperature range	[MPa]	-0.095 ... +0.6			
	[bar]	-0.95 ... +6			
	[psi]	-13,775 ... +87			
Operating medium	Compressed air to ISO 8573-1:2010 [7:-:-]				
	Water as per manufacturer's declaration ¹⁾				
Suitable for the production of lithium-ion batteries	Metals with more than 1% by mass of copper, zinc or nickel are excluded from use. Exceptions are nickel in steel, chemically nickel-plated surfaces, printed circuit boards, cables, electrical plug connectors and coils.				
Cleanroom class	Element installed statically, no meaningful evaluation possible according to ISO 14644-1				
Ambient temperature [°C]	-35 ... +60				
Food-safe ¹⁾	See supplementary material information				
Material fire test	UL94 HB				
Certification ¹⁾	German Technical Control Board (TÜV)				
Certificate-issuing authority	B 013277 0506 00				
Tubing characteristics	Suitable for energy chains				

1) More information: www.festo.com/catalogue/pun-h → Support/Downloads.

Operating pressure p as a function of temperature t

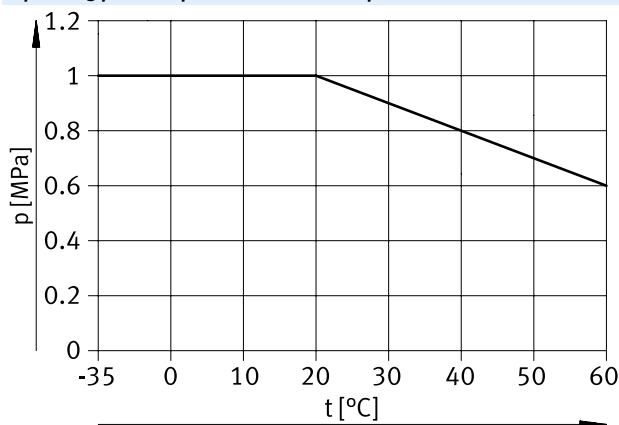

Operating pressure p as a function of temperature t (medium: water)

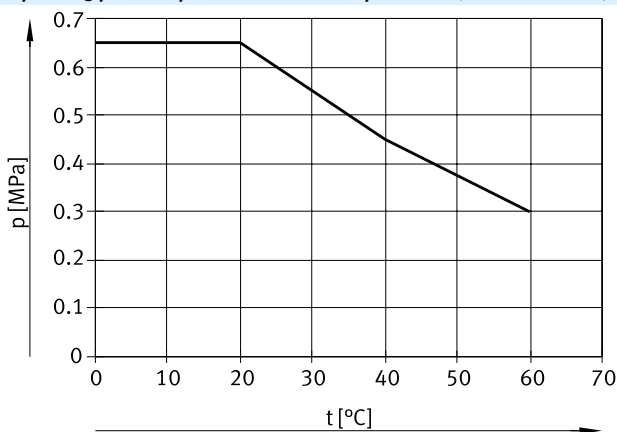

Datasheet

Materials

Shore hardness	D 52 ±3
Tubing	TPE-U(PU)
Note on materials	RoHS-compliant
LABS (PWIS) conformity	VDMA24364-B2-L
Suitable for the production of lithium-ion batteries	Metals with more than 1% by mass of copper, zinc or nickel are excluded from use. Exceptions are nickel in steel, chemically nickel-plated surfaces, printed circuit boards, cables, electrical plug connectors and coils.
Cleanroom class	Element installed statically, no meaningful evaluation possible according to ISO 14644-1
Application information	TPE-U, ether-based

Dimensions and ordering data

O.D. [mm]	I.D. [mm]	Min. bending radius [mm]	Flow-relevant bending radius [mm]	Weight [kg/m]	Colour	Part no.	Type	PJ ¹⁾ [m]
4	2.6	8	16	0.017	Blue/black	197396	PUN-H-4x0.75-DUO	50
6	4	10	26	0.0366		197397	PUN-H-6x1-DUO	50
8	5.7	21	37	0.0574		197398	PUN-H-8x1.25-DUO	50
10	7	28	52	0.093		197399	PUN-H-10x1.5-DUO	50

1) Packaging unit

Type codes

001	Series
PUN	Plastic tubing, polyurethane

002	Alternative material characteristic
H	Hydrolysis-resistant

003	Additional features
F	Food-safe

004	Pipe/tubing O.D. x wall thickness
4x0,75	4x0.75 mm
6x1	6x1 mm
8x1,25	8x1.25 mm
10x1,5	10x1.5 mm
12x2	12x2 mm
14x2	14x2 mm
16x2,5	16x2.5 mm

005	Colour
NT	Natural
TBL	Translucent blue
SW	Black
BL	Blue
RT	Red
GN	Green
GE	Yellow

Datasheet

Plastic tubing PUN-H-F

With O.D. 4 ... 16 mm

Suitable for contact with food.

Material: Polyurethane



Operating and environmental conditions

Type		PUN-H-F-4	PUN-H-F-6	PUN-H-F-8	PUN-H-F-10	PUN-H-F-12	PUN-H-F-14	PUN-H-F-16	
O.D.	[mm]	4	6	8	10	12	14	16	
Pneumatic connection									
	For push-in connector	[mm]	4	6	8	10	12	14	16
	For barbed connector with union nut	[mm]	3	4	6	10	–	–	–
Temperature-dependent operating pressure	[MPa]	–0.095 ... 1 MPa → graph							
	[bar]	–0.95 ... 10 bar							
	[psi]	–13.775 ... 145 psi							
Operating pressure for full temperature range	[MPa]	–0.095 ... 0.6 MPa							
	[bar]	–0.95 ... 6 bar							
	[psi]	–13.775 ... 87 psi							
Note on operating pressure		Water: max. 0.65 MPa at 20°C, max. 0.45 MPa at 40°C, max. 0.3 MPa at 60°C							
Operating medium		Compressed air to ISO 8573-1:2010 [7:--]							
		Water (liquid, ice-free) ¹⁾							
		Oxygen ²⁾							
Food-safe		See declaration of conformity ¹⁾							
Ambient temperature	[°C]	–35 ... 60							
Material fire test		UL94 HB							
Tubing characteristics		Suitable for energy chains							

1) More information: www.festo.com/catalogue/pun-h-f → Support/Downloads.

2) Applies only to NT variants (colour: natural).

Operating pressure p as a function of temperature t

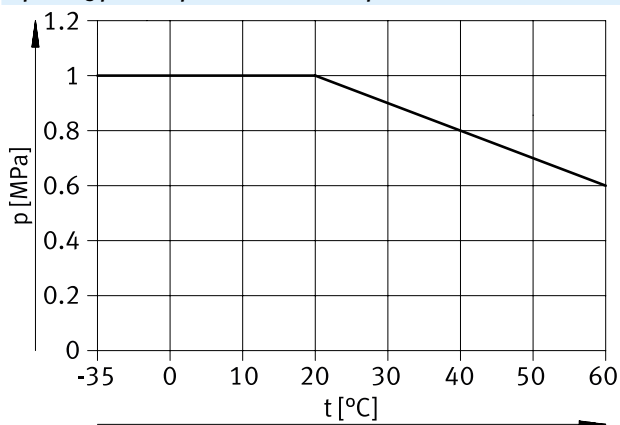

Operating pressure p as a function of temperature t (medium: water)

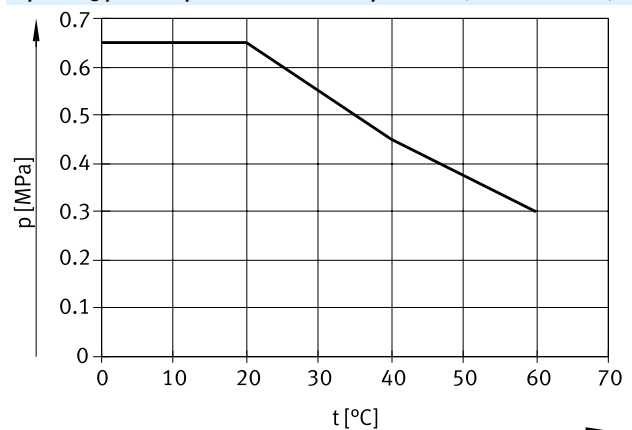

Materials

Shore hardness	D 52 ±3
Tubing	TPE-U(PU)
Note on materials	RoHS-compliant
LABS (PWIS) conformity	VDMA24364-B2-L
Application information	Tubing without printing TPE-U, ether-based

Datasheet

Dimensions and ordering data								
O.D. [mm]	I.D. [mm]	Min. bending radius [mm]	Flow-relevant bending radius [mm]	Weight [kg/m]	Colour	Part no.	Type	PU ¹⁾ [m]
4	2.6	8	16	0.0084	Natural	8153378	PUN-H-F-4X0.75-NT	50
					Red	8153379	PUN-H-F-4X0.75-RT	50
					Blue	8153381	PUN-H-F-4X0.75-BL	50
					Translucent blue	8153382	PUN-H-F-4X0.75-TBL	50
					Green	8153383	PUN-H-F-4X0.75-GN	50
					Yellow	8153384	PUN-H-F-4X0.75-GE	50
					Black	8153385	PUN-H-F-4X0.75-SW	50
6	4	10	26	0.0181	Natural	8153428	PUN-H-F-6X1-NT	50
					Red	8153386	PUN-H-F-6X1-RT	50
					Blue	8153388	PUN-H-F-6X1-BL	50
					Translucent blue	8153389	PUN-H-F-6X1-TBL	50
					Green	8153390	PUN-H-F-6X1-GN	50
					Yellow	8153391	PUN-H-F-6X1-GE	50
					Black	8153392	PUN-H-F-6X1-SW	50
8	5.7	21	37	0.0285	Natural	8153429	PUN-H-F-8X1.25-NT	50
					Red	8153393	PUN-H-F-8X1.25-RT	50
					Blue	8153395	PUN-H-F-8X1.25-BL	50
					Translucent blue	8153396	PUN-H-F-8X1.25-TBL	50
					Green	8153397	PUN-H-F-8X1.25-GN	50
					Yellow	8153398	PUN-H-F-8X1.25-GE	50
					Black	8153399	PUN-H-F-8X1.25-SW	50
10	7	28	52	0.0461	Natural	8153430	PUN-H-F-10X1.5-NT	50
					Red	8153400	PUN-H-F-10X1.5-RT	50
					Blue	8153402	PUN-H-F-10X1.5-BL	50
					Translucent blue	8153403	PUN-H-F-10X1.5-TBL	50
					Green	8153404	PUN-H-F-10X1.5-GN	50
					Yellow	8153405	PUN-H-F-10X1.5-GE	50
					Black	8153406	PUN-H-F-10X1.5-SW	50
12	8	33	62	0.0723	Natural	8153407	PUN-H-F-12X2-NT	50
					Red	8153408	PUN-H-F-12X2-RT	50
					Blue	8153410	PUN-H-F-12X2-BL	50
					Translucent blue	8153411	PUN-H-F-12X2-TBL	50
					Green	8153412	PUN-H-F-12X2-GN	50
					Yellow	8153413	PUN-H-F-12X2-GE	50
					Black	8153414	PUN-H-F-12X2-SW	50
14	9.8	38	78	0.0911	Natural	8153415	PUN-H-F-14X2-NT	50
					Red	8153416	PUN-H-F-14X2-RT	50
					Blue	8153417	PUN-H-F-14X2-BL	50
					Black	8153418	PUN-H-F-14X2-SW	50
16	11	38	88	0.122	Natural	8153419	PUN-H-F-16X2.5-NT	50
					Red	8153420	PUN-H-F-16X2.5-RT	50
					Blue	8153422	PUN-H-F-16X2.5-BL	50
					Translucent blue	8153423	PUN-H-F-16X2.5-TBL	50
					Green	8153424	PUN-H-F-16X2.5-GN	50
					Yellow	8153425	PUN-H-F-16X2.5-GE	50
					Black	8153426	PUN-H-F-16X2.5-SW	50

1) Packaging unit

Type codes

001	Baureihe
PUN	Kunststoffschlauch, Polyurethan
002	Alternative Materialeigenschaft
H	Hydrolysebeständig
003	Zusatzeigenschaften
SF	Robust und flexibel

004	Rohr-/Schlauchaußendurchmesser x Wandstärke
4x0,85	4x0,85 mm
6x1,25	6x1,25 mm
8x1,55	8x1,55 mm
10x2	10x2 mm
12x2,3	12x2,3 mm
14x2,7	14x2,7 mm
16x3,1	16x3,1 mm
18x3,4	18x3,4 mm
22x4,3	22x4,3 mm
25x4,85	25x4,85 mm

005	Farbe
SW	Schwarz
BL	Blau

006	Packungseinheit [m]
	Standard
25	25 m

Datasheet

Plastic tubing PUN-H-SF

With O.D. 4 ... 25 mm

Material: Polyurethane

Robust and flexible.
Resistant to kinking and hydrolysis.
High thermal and mechanical load capacities.



Operating and environmental conditions

Type		PUN-H-SF-4	PUN-H-SF-6	PUN-H-SF-8	PUN-H-SF-10	PUN-H-SF-12	PUN-H-SF-14	PUN-H-SF-16	PUN-H-SF-18	PUN-H-SF-22	PUN-H-SF-25
O.D.	[mm]	4	6	8	10	12	14	16	18	22	25
Pneumatic connection											
For push-in connector	[mm]	4	6	8	10	12	14	16	–	22	–
Temperature-dependent operating pressure	[MPa]	–0.095 ... 1.3 MPa → graph									
	[bar]	–0.95 ... 13 bar									
	[psi]	–13.775 ... 188.5 psi									
Operating pressure for full temperature range	[MPa]	–0.095 ... 0.6 MPa									
	[bar]	–0.95 ... 6 bar									
	[psi]	–13.775 ... 87 psi									
Note on operating pressure		Water: max. 1 MPa at 25°C, max. 0.75 MPa at 40°C, max. 0.7 MPa at 60°C									
Operating medium		Compressed air to ISO 8573-1:2010 [7:–:–]									
		Water (liquid, ice-free) ¹⁾									
Food-safe		See supplementary material information ¹⁾									
Ambient temperature	[°C]	–35 ... 80									
Material fire test		UL94 HB									
Tubing characteristics		Suitable for energy chains									

¹⁾ More information: www.festo.com/catalogue/pun-h-sf → Support/Downloads.

Operating pressure p as a function of temperature t

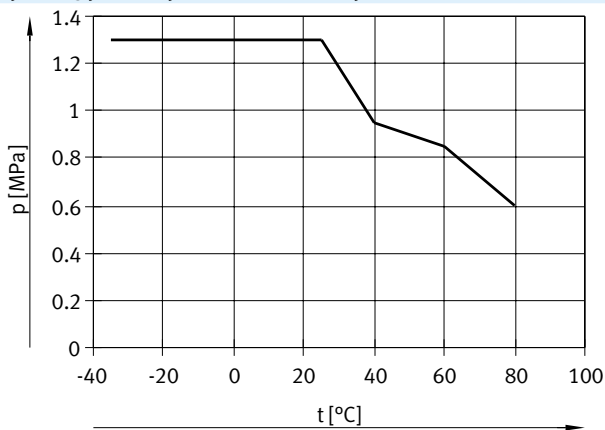

Operating pressure p as a function of temperature t (medium: water)

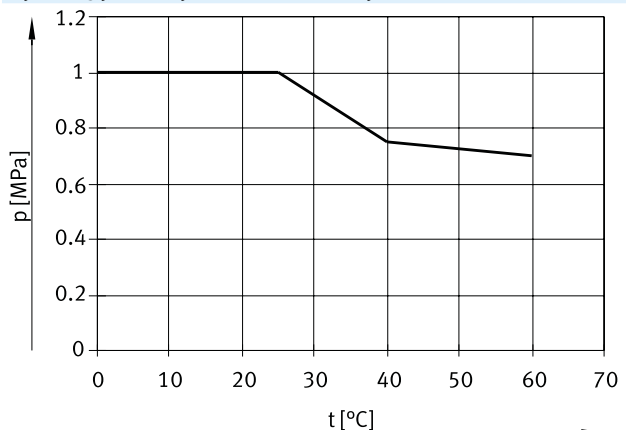

Materials

Shore hardness	D 54 +/-3
Tubing	TPE-U(PU)
Note on materials	RoHS-compliant
LABS (PWIS) conformity	VDMA24364-B2-L
Cleanroom class	Element installed statically, no meaningful evaluation possible according to ISO 14644-1
Application information	TPE-U, ether-based

Datasheet

Dimensions and ordering data								
O.D.	I.D.	Min. bending radius	Flow-relevant bending radius	Weight	Colour	Part no.	Type	PU ¹⁾
[mm]	[mm]	[mm]	[mm]	[kg/m]				[m]
4	2.3	7	12	0.01	Black	8174911	PUN-H-SF-4X0.85-SW	50
					Blue	8174912	PUN-H-SF-4X0.85-BL	50
6	3.5	12	25	0.025	Black	8167899	PUN-H-SF-6X1.25-SW	50
					Blue	8167900	PUN-H-SF-6X1.25-BL	50
8	4.9	15	35	0.04	Black	8167901	PUN-H-SF-8X1.55-SW	50
					Blue	8167902	PUN-H-SF-8X1.55-BL	50
10	6	16	42	0.061	Black	8167905	PUN-H-SF-10X2-SW	50
					Blue	8167904	PUN-H-SF-10X2-BL	50
12	7.4	21	49	0.085	Black	8167906	PUN-H-SF-12X2.3-SW	50
					Blue	8167907	PUN-H-SF-12X2.3-BL	50
14	8.6	26	60	0.118	Black	8167908	PUN-H-SF-14X2.7-SW	50
					Blue	8167909	PUN-H-SF-14X2.7-BL	50
16	9.85	30	73	0.145	Black	8167910	PUN-H-SF-16X3.1-SW	50
					Blue	8167911	PUN-H-SF-16X3.1-BL	50
18	11.2	36	90	0.188	Black	8167913	PUN-H-SF-18X3.4-SW-25	25
					Blue	8167912	PUN-H-SF-18X3.4-BL-25	25
22	13.4	44	110	0.302	Black	8167914	PUN-H-SF-22X4.3-SW-25	25
					Blue	8167915	PUN-H-SF-22X4.3-BL-25	25
25	15.3	55	130	0.372	Black	8167917	PUN-H-SF-25X4.85-SW-25	25
					Blue	8167916	PUN-H-SF-25X4.85-BL-25	25

1) Packaging unit

Type codes

001		Baureihe
PUN		Kunststoffschlauch, Polyurethan
002		Alternative Materialeigenschaft
V0		Flammhemmend
003		Rohr-/Schlauchaußendurchmesser x Wandstärke
4x1		4x1 mm
6x1		6x1 mm
6x2		6x2 mm
8x1,25		8x1,25 mm
8x2		8x2 mm
10x1,5		10x1,5 mm
10x2		10x2 mm
12x2		12x2 mm
14x2		14x2 mm
16x2		16x2 mm
16x2,5		16x2,5 mm

004		Farbe
SW		Schwarz
BL		Blau
RT		Rot
GN		Grün
GE		Gelb
BR		Braun
WS		Weiß
005		Ausführung
C		Dickere Wandstärke

Datasheet

Plastic tubing PUN-V0

Highly flexible single-sheath plastic tubing, flame-retardant

Material: Polyurethane

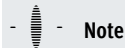

Note

As this tubing is flame-retardant, the colours differ from the standard colours.



Operating and environmental conditions

Type		PUN-V0-6	PUN-V0-8	PUN-V0-10	PUN-V0-16
O.D.	[mm]	6	8	10	16
Pneumatic connection					
For push-in connector	[mm]	6	8	10	16
For barbed connector	[mm]	4	6	–	–
For barbed connector with union nut	[mm]	4	6	–	–
Temperature-dependent operating pressure	[MPa]	–0.095 ... +1 → graph			–0.095 ... +0.9 → graph
	[bar]	–0.95 ... +10			–0.95 ... +9
	[psi]	–13.775 ... 145			–13.775 ... 130.5
Operating pressure for full temperature range	[MPa]	–0.095 ... +7			–0.095 ... +0.6
	[bar]	–0.95 ... +7			–0.95 ... +6
	[psi]	–13.775 ... 101.5			–13.775 ... 87
Note on operating pressure		Water: max. 0.6 MPa at max. 50°C			
Operating medium		Compressed air to ISO 8573-1:2010 [7:--] Water (liquid, ice-free)			
Ambient temperature	[°C]	–35 ... +60			
Note on ambient temperature		Unpressurised use up to 90 °C			
Material fire test		UL94 V-0 (for test specimen 3 mm thick)			
		UL94 V-2 (for test specimen 0.75 mm thick)			
Certification ¹⁾		German Technical Control Board (TÜV)			
Certificate-issuing authority		B 013277 0506 00			
Tubing characteristics		Suitable for energy chains			

1) More information: www.festo.com/catalogue/pun → Support/Downloads.

Operating pressure p as a function of temperature t

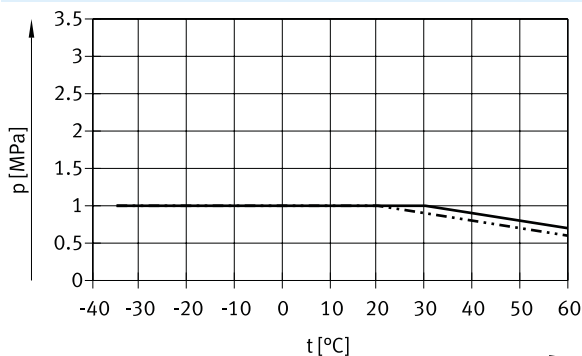

— PUN-V0-6/8/10

- - - PUN-V0-16

Materials

Shore hardness	D 54 ±3
Tubing	TPE-U(PU)
Note on materials	RoHS-compliant
LABS (PWIS) conformity	VDMA24364-B2-L

Datasheet

Dimensions and ordering data

O.D. [mm]	I.D. [mm]	Min. bending radius [mm]	Flow-relevant bending radius [mm]	Weight [kg/m]	Colour	Part no.	Type	PU ¹⁾ [m]
6	4	12	26.5	0.02	Black	525438	PUN-V0-6x1-SW	50
					Blue	525442	PUN-V0-6x1-BL	50
					Green	525446	PUN-V0-6x1-GN	50
					Red	525450	PUN-V0-6x1-RT	50
					White	525454	PUN-V0-6x1-WS	50
					Yellow	525458	PUN-V0-6x1-GE	50
					Brown	525462	PUN-V0-6x1-BR	50
8	5.7	18	37	0.031	Black	525439	PUN-V0-8x1.25-SW	50
					Blue	525443	PUN-V0-8x1.25-BL	50
					Green	525447	PUN-V0-8x1.25-GN	50
					Red	525451	PUN-V0-8x1.25-RT	50
					White	525455	PUN-V0-8x1.25-WS	50
					Yellow	525459	PUN-V0-8x1.25-GE	50
					Brown	525463	PUN-V0-8x1.25-BR	50
10	7	20	54	0.051	Black	525440	PUN-V0-10x1.5-SW	50
					Blue	525444	PUN-V0-10x1.5-BL	50
					Green	525448	PUN-V0-10x1.5-GN	50
					Red	525452	PUN-V0-10x1.5-RT	50
					White	525456	PUN-V0-10x1.5-WS	50
					Yellow	525460	PUN-V0-10x1.5-GE	50
					Brown	525464	PUN-V0-10x1.5-BR	50
16	11.8	50	90	0.122	Black	570767	PUN-V0-16x2-SW	50
					Blue	570768	PUN-V0-16x2-BL	50

1) Packaging unit

Datasheet

Plastic tubing PUN-V0-C

Highly flexible single-sheath plastic tubing, flame-retardant

For use in the immediate vicinity of welding applications.

Material: Polyurethane

Note
As this tubing is flame-retardant, the colours differ from the standard colours.



Operating and environmental conditions

Type	PUN-V0-4...-C	PUN-V0-6...-C	PUN-V0-8...-C	PUN-V0-10...-C	PUN-V0-12...-C	PUN-V0-14...-C	PUN-V0-16...-C
O.D. [mm]	4	6	8	10	12	14	16
Pneumatic connection							
For push-in connector [mm]	4	6	8	10	12	14	16
For barbed connector [mm]	–	2	4	6	–	–	–
Temperature-dependent operating pressure	[MPa]	–0.095 ... +1 → graph	–0.095 ... +3 → graph	–0.095 ... +2 → graph	–0.095 ... +1.6 → graph	–0.095 ... +1 → graph	–0.095 ... +0.9 → graph
	[bar]	–0.95 ... +10	–0.95 ... +30	–0.95 ... +20	–0.95 ... +16	–0.95 ... +10	–0.95 ... +9
	[psi]	–13,775 ... +145	–13,775 ... +435	–13,775 ... +290	–13,775 ... +232	–13,775 ... +145	–13,775 ... +130.5
Operating pressure for full temperature range	[MPa]	–0.095 ... +0.7	–0.095 ... +1.6	–0.095 ... +1.2	–0.095 ... +0.9	–0.095 ... +0.7	–0.095 ... +0.6
	[bar]	–0.95 ... +7	–0.95 ... +16	–0.95 ... +12	–0.95 ... +9	–0.95 ... +7	–0.95 ... +6
	[psi]	–13,775 ... +101.5	–13,775 ... +232	–13,775 ... +174	–13,775 ... +130.5	–13,775 ... +101.5	–13,775 ... +87
Note on operating pressure ¹⁾	Water: max. 0.6 MPa at max. 50°C						
Operating medium	Compressed air to ISO 8573-1:2010 [7:::] Water (liquid, ice-free)						
Ambient temperature [°C]	–35 ... +60						
Note on ambient temperature	Unpressurised use up to 90 °C						
Material fire test	UL94 V-0 (for test specimen 3 mm thick)						
	UL94 V-2 (for test specimen 0.75 mm thick)						
Certification ²⁾	German Technical Control Board (TÜV)						
Certificate-issuing authority	B 013277 0506 00						
Tubing characteristics	Suitable for energy chains						

1) For O.D. 6, 8 and 10, the following applies: For applications with welding spatter → max. 1 MPa at 20°C, max. 0.9 MPa at 40°C, max. 0.7 MPa at 60°C

2) More information: www.festo.com/catalogue/pun → Support/Downloads.

Operating pressure p as a function of temperature t

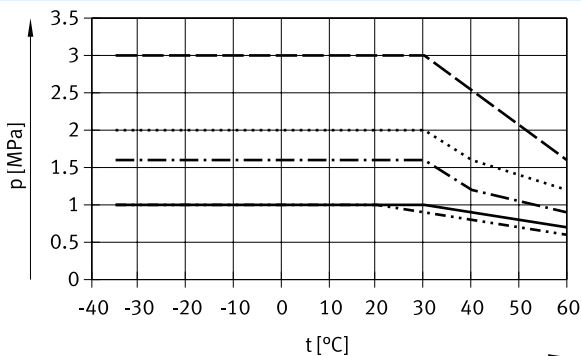

— PUN-V0-...-C
- - - - PUN-V0-14x2-...-C

For applications without welding spatter

— — — — PUN-V0-6x2-...-C
..... PUN-V0-8x2-...-C
- · - · - · PUN-V0-10x2-...-C

Datasheet

Materials	
Shore hardness	D 54 ±3
Tubing	TPE-U(PU)
Note on materials	RoHS-compliant
LABS (PWIS) conformity	VDMA24364-B2-L

Datasheet

Dimensions and ordering data								
O.D.	I.D.	Min. bending radius	Flow-relevant bending radius	Weight	Colour	Part no.	Type	PJ ¹⁾
[mm]	[mm]	[mm]	[mm]	[kg/m]				[m]
4	2	10	20	0.012	Black	570349	PUN-V0-4x1-SW-C	50
					Blue	570350	PUN-V0-4x1-BL-C	50
6	2	7	24	0.032	Black	561698	PUN-V0-6x2-SW-C	50
					Blue	561702	PUN-V0-6x2-BL-C	50
					Green	561706	PUN-V0-6x2-GN-C	50
					Red	561710	PUN-V0-6x2-RT-C	50
					White	561714	PUN-V0-6x2-WS-C	50
					Yellow	561718	PUN-V0-6x2-GE-C	50
					Brown	561722	PUN-V0-6x2-BR-C	50
8	4	9	35	0.049	Black	561699	PUN-V0-8x2-SW-C	50
					Blue	561703	PUN-V0-8x2-BL-C	50
					Green	561707	PUN-V0-8x2-GN-C	50
					Red	561711	PUN-V0-8x2-RT-C	50
					White	561715	PUN-V0-8x2-WS-C	50
					Yellow	561719	PUN-V0-8x2-GE-C	50
					Brown	561723	PUN-V0-8x2-BR-C	50
10	6	12	42	0.064	Black	561700	PUN-V0-10x2-SW-C	50
					Blue	561704	PUN-V0-10x2-BL-C	50
					Green	561708	PUN-V0-10x2-GN-C	50
					Red	561712	PUN-V0-10x2-RT-C	50
					White	561716	PUN-V0-10x2-WS-C	50
					Yellow	561720	PUN-V0-10x2-GE-C	50
					Brown	561724	PUN-V0-10x2-BR-C	50
12	8	19	55	0.08	Black	561701	PUN-V0-12x2-SW-C	50
					Blue	561705	PUN-V0-12x2-BL-C	50
					Green	561709	PUN-V0-12x2-GN-C	50
					Red	561713	PUN-V0-12x2-RT-C	50
					White	561717	PUN-V0-12x2-WS-C	50
					Yellow	561721	PUN-V0-12x2-GE-C	50
					Brown	561725	PUN-V0-12x2-BR-C	50
14	9.8	45	70	0.096	Black	570351	PUN-V0-14x2-SW-C	50
					Blue	570352	PUN-V0-14x2-BL-C	50
16	11	50	90	0.147	Black	570353	PUN-V0-16x2.5-SW-C	50
					Blue	570354	PUN-V0-16x2.5-BL-C	50

1) Packaging unit

Ordering data – Modular product system

Ordering table (minimum order quantity 3000 m for tubing O.D. ≤ 8 mm, 1500 mm for tubing O.D. > 8 mm, rounded value 25 m)												
Size	3	4	6	8	10	12	14	16	Conditions	Code	Enter code	
Module no.	553573											
Function	Polyurethane tubing, standard O.D.										PUN	PUN
Alternative material characteristic	Standard											
	Hydrolysis-resistant										-H	
	-	Anti-static			-			-		-CM		
	-	Flame-retardant			-			-		-VO		
	-	Resistant to welding spatter										-VOC
Tubing O.D. [mm]	3	-	-	-	-	-	-	-		-3		
	-	4	-	-	-	-	-	-		-4		
	-	-	6	-	-	-	-	-		-6		
	-	-	-	8	-	-	-	-		-8		
	-	-	-	-	10	-	-	-		-10		
	-	-	-	-	-	12	-	-		-12		
	-	-	-	-	-	-	14	-		-14		
	-	-	-	-	-	-	-	16		-16		
Colour	Silver										[1] [2]	-SI
	Blue										[1] [3]	-BL
	Translucent blue										[4]	-TBL
	Black										[3]	-SW
	Translucent black										[4]	-TSW
	Yellow										[1]	-GE
	Translucent yellow										[4]	-TGE
	Green										[1]	-GN
	Translucent green										[4]	-TGN
	Red										[1]	-RT
	Translucent red										[4]	-TRT
	Brown										[1]	-BR
	White										[1]	-WS
	Natural										[1] [3] [4]	-NT
Labelling text (on request)	Standard											
	Customer-specific tubing inscription										[5]	-TXT
Packaging unit [m]	25											-25
	50											-50
	100											-100
	200										-	-200
	300										-	-300
	400										-	-400
	500										-	-500
Packaging	Cardboard box										[6]	-CB
	Reel										[7]	-HA

- [1] SI, BL, GE, GN, RT, BR, WS, NT Not with alternative material characteristic CM
- [2] SI Not with alternative material characteristic V0, V0CO
- [3] BL, SW, NT In combination with alternative material characteristic H: food-safe
- [4] TBL, TSW, TGE, TGN, TRT, NT Only with alternative material characteristic H
- [5] TXT Not in the Online Shop.
Festo logo, order code, TÜV, operating pressure, dimensions omitted
- [6] CB Only with packaging unit 25, 50
- [7] HA Not with packaging unit 25, 50
Not with alternative material characteristic V0, VOC, CM

Type codes

001	Series
PAN	Standard O.D. tubing

002	Function
PAN	Polyamide tubing, standard O.D.

003	Pipe/tubing O.D. x wall thickness
4x0,75	4x0.75 mm
6x1	6x1 mm
8x1,25	8x1.25 mm
10x1,5	10x1.5 mm
12x1,75	12x1.75 mm
14x2	14x2 mm
16x2	16x2 mm

004	Colour
NT	Natural
SW	Black
BL	Blue
SI	Silver
RT	Red
GN	Green
GE	Yellow

005	Packaging unit [m]
	Standard
100	100 m
200	200 m
300	300 m
400	400 m
500	500 m

Datasheet

Plastic tubing PAN

High thermal and mechanical load capacities.

Material: Polyamide



Operating and environmental conditions

Type	PAN-4	PAN-6	PAN-8	PAN-10	PAN-12	PAN-14	PAN-16
O.D. [mm]	4	6	8	10	12	14	16
Pneumatic connection							
For push-in connector [mm]	4	6	8	10	12	14	16
For barbed connector [mm]	3	4	6	-	-	-	-
For barbed connector with union nut [mm]	3	4	6	-	-	-	-
Temperature-dependent operating pressure	[MPa]	-0.095 ... +1.5 → graph	-0.095 ... +1.9 → graph	-0.095 ... +1.5 → graph	-0.095 ... +1.7 → graph		-0.095 ... +1.4 → graph
	[bar]	-0.95 ... +15	-0.95 ... +19	-0.95 ... +15	-0.95 ... +17		-0.95 ... +14
	[psi]	-13,775 ... +217.5	-13,775 ... +275.5	-13,775 ... +217.5	-13,775 ... +246.5		-13,775 ... +203
Operating medium	Compressed air to ISO 8573-1:2010 [7:-:-]						
Ambient temperature [°C]	-30 ... +80						
Certification	German Technical Control Board (TÜV)						
Certificate-issuing authority	B 013277 0506 00						
Maritime classification	See certificate (colours: silver and natural) ¹⁾						
Tubing characteristics	Suitable for energy chains						

1) More information: www.festo.com/catalogue/pan → Support/Downloads.

Operating pressure p as a function of temperature t

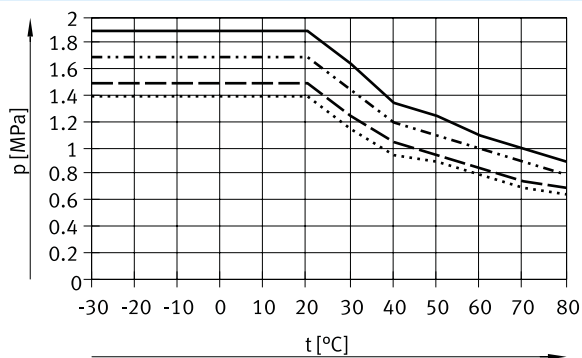

- PAN-6
- - - PAN-4/8
- · - · - PAN-10/12/14
- PAN-16

Materials

Shore hardness	D 55 ±3
Tubing	TPE-A
Note on materials	RoHS-compliant
LABS (PWIS) conformity	VDMA24364-B2-L

Datasheet

Dimensions – Reel

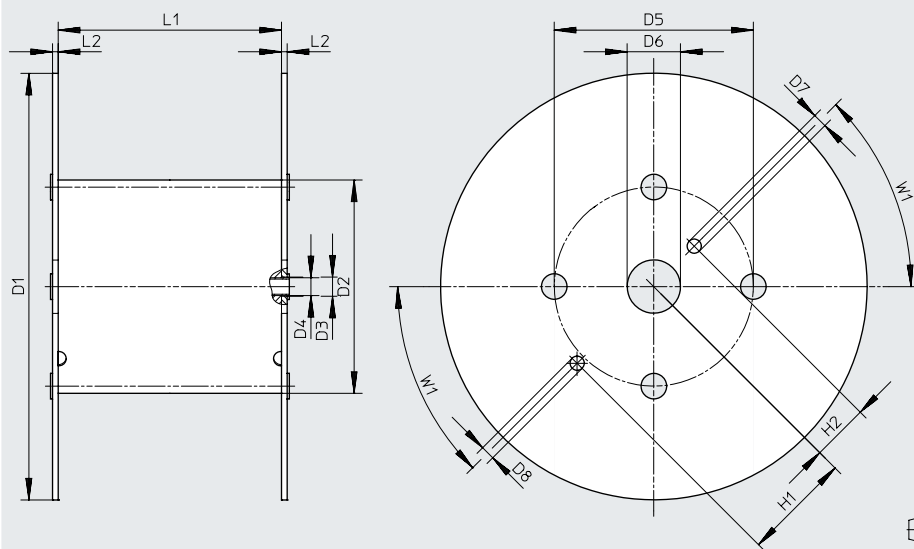

Type	D1 ø	D2 ø	D3 ø	D4 ø	D5 ø	D6 ø	D7 ø	D8 ø	H1	H2	L1	L2	W1
For PAN-4x0.75-...-500	545	246	21	20	216	75	20	20	152.5	80.5	128	8	45°
For PAN-6x1-...-500	545	246	21	20	216	75	20	20	152.5	80.5	128	8	45°
For PAN-8x1.25-...-400	545	310	21	20	280	75	20	20	152.5	80.5	254	8	45°
For PAN-10x1.5-...-300	600	310	21	20	280	75	20	20	152.5	80.5	254	8	45°
For PAN-12x1.75-...-200	600	310	21	20	280	75	20	20	152.5	80.5	254	8	45°
For PAN-16x2-...-100	545	310	21	20	280	75	20	20	152.5	80.5	254	8	45°

Dimensions and ordering data

O.D. [mm]	I.D. [mm]	Min. bending radius [mm]	Flow-relevant bending radius [mm]	Weight [kg/m]	Colour	Part no.	Type	PJ ¹⁾ [m]
4	2.9	12	18	0.006	Silver	152697	PAN-4x0.75-SI	50
					Silver	553888	PAN-4x0.75-SI-500	500
					Blue	553906	PAN-4x0.75-BL	50
					Blue	553894	PAN-4x0.75-BL-500	500
					Black	553912	PAN-4x0.75-SW	50
					Black	553900	PAN-4x0.75-SW-500	500
					Natural	546284	PAN-4x0.75-NT	50
					Green	553918	PAN-4x0.75-GN	50
					Red	553924	PAN-4x0.75-RT	50
					Yellow	553930	PAN-4x0.75-GE	50
6	4	14	32	0.016	Silver	152699	PAN-6x1-SI	50
					Silver	553889	PAN-6x1-SI-500	500
					Blue	553907	PAN-6x1-BL	50
					Blue	553895	PAN-6x1-BL-500	500
					Black	553913	PAN-6x1-SW	50
					Black	553901	PAN-6x1-SW-500	500
					Natural	546285	PAN-6x1-NT	50
					Green	553919	PAN-6x1-GN	50
					Red	553925	PAN-6x1-RT	50
					Yellow	553931	PAN-6x1-GE	50

1) Packaging unit

Datasheet

Dimensions and ordering data

O.D. [mm]	I.D. [mm]	Min. bending radius [mm]	Flow-relevant bending radius [mm]	Weight [kg/m]	Colour	Part no.	Type	PU ¹⁾ [m]					
8	5.9	22	43	0.024	Silver	152700	PAN-8x1.25-SI	50					
					Silver	553890	PAN-8x1.25-SI-400	400					
					Blue	553908	PAN-8x1.25-BL	50					
					Blue	553896	PAN-8x1.25-BL-400	400					
					Black	553914	PAN-8x1.25-SW	50					
					Black	553902	PAN-8x1.25-SW-400	400					
					Natural	546286	PAN-8x1.25-NT	50					
					Green	553920	PAN-8x1.25-GN	50					
					Red	553926	PAN-8x1.25-RT	50					
10	7	27	58	0.042	Yellow	553932	PAN-8x1.25-GE	50					
					Silver	152701	PAN-10x1.5-SI	50					
					Silver	553891	PAN-10x1.5-SI-300	300					
					Blue	553909	PAN-10x1.5-BL	50					
					Blue	553897	PAN-10x1.5-BL-300	300					
					Black	553915	PAN-10x1.5-SW	50					
					Black	553903	PAN-10x1.5-SW-300	300					
					Natural	546287	PAN-10x1.5-NT	50					
					Green	553921	PAN-10x1.5-GN	50					
12	8.4	29	64	0.060	Red	553927	PAN-10x1.5-RT	50					
					Yellow	553933	PAN-10x1.5-GE	50					
					Silver	152702	PAN-12x1.75-SI	50					
					Silver	553892	PAN-12x1.75-SI-200	200					
					Blue	553910	PAN-12x1.75-BL	50					
					Blue	553898	PAN-12x1.75-BL-200	200					
					Black	553916	PAN-12x1.75-SW	50					
					Black	553904	PAN-12x1.75-SW-200	200					
					Natural	546288	PAN-12x1.75-NT	50					
14	10	50	80	0.077	Green	553922	PAN-12x1.75-GN	50					
					Red	553928	PAN-12x1.75-RT	50					
					Yellow	553934	PAN-12x1.75-GE	50					
					Silver	570392	PAN-14x2-SI	50					
					16	12	67	94	0.092	Silver	152703	PAN-14x2-SI	50
										Silver	553893	PAN-16x2-SI-100	100
										Blue	553911	PAN-16x2-BL	50
										Blue	553899	PAN-16x2-BL-100	100
										Black	553917	PAN-16x2-SW	50
Black	553905	PAN-16x2-SW-100	100										
Natural	546289	PAN-16x2-NT	50										
Green	553923	PAN-16x2-GN	50										
Red	553929	PAN-16x2-RT	50										
Yellow	553935	PAN-16x2-GE	50										

1) Packaging unit

Type codes

001	Series
PAN	Standard O.D. tubing

002	Alternative material characteristic
R	Sturdy

003	Pipe/tubing O.D. x wall thickness
4x0,75	4x0.75 mm
6x1,1	6x1.1 mm
8x1,5	8x1.5 mm
10x1,9	10x1.9 mm
12x2,2	12x2.2 mm
16x3	16x3 mm
22x2	22x2 mm
28x2,5	28x2.5 mm

004	Colour
SW	Black
SI	Silver

Datasheet

Plastic tubing PAN-R

With O.D. 4 ... 16 mm

For applications with a high pressure range.

Material: Polyamide



Operating and environmental conditions

Type	PAN-R-4	PAN-R-6	PAN-R-8	PAN-R-10	PAN-R-12	PAN-R-16
O.D. [mm]	4	6	8	10	12	16
Pneumatic connection						
For push-in connector [mm]	4	6	8	10	12	16
Temperature-dependent operating pressure	-0.095 ... +3.5 → graph [MPa]					
	-0.95 ... +35 [bar]					
	-13,775 ... +507.5 [psi]					
Operating medium	Compressed air to ISO 8573-1:2010 [7:-:-]					
Ambient temperature [°C]	-30 ... +80					
Certification	German Technical Control Board (TÜV)					
Certificate-issuing authority	B 013277 0506 00					
Tubing characteristics	Suitable for energy chains					

Operating pressure p as a function of temperature t

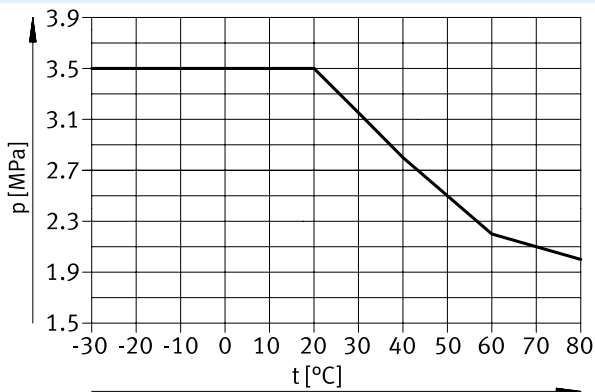

Materials

Shore hardness	D 62 ±3
Tubing	TPE-A
Note on materials	RoHS-compliant
LABS (PWIS) conformity	VDMA24364-B2-L

Dimensions and ordering data

O.D. [mm]	I.D. [mm]	Min. bending radius [mm]	Flow-relevant bending radius [mm]	Weight [kg/m]	Colour	Part no.	Type	PU ¹⁾ [m]
4	2.5	10	16	0.0079	Silver	541674	PAN-R-4x0.75-SI	50
6	3.8	16	21	0.0174		541675	PAN-R-6x1.1-SI	50
8	5	20	29	0.0316		541676	PAN-R-8x1.5-SI	50
10	6.2	25	44	0.0498		541677	PAN-R-10x1.9-SI	50
12	7.6	30	46	0.0698		541678	PAN-R-12x2.2-SI	50
16	10	42	73	0.1262		541679	PAN-R-16x3-SI	50

1) Packaging unit

Datasheet

Plastic tubing PAN-R

With O.D. 22 and 28 mm

High thermal and mechanical load capacities.

Material: Polyamide



Operating and environmental conditions

Type	PAN-R-22	PAN-R-28
O.D. [mm]	22	28
Pneumatic connection		
For push-in connector [mm]	22	28
Temperature-dependent operating pressure	-0.95 ... +14 → graph	
Operating medium	Compressed air to ISO 8573-1:2010 [7:-:-]	
Ambient temperature [°C]	-30 ... +80	

Operating pressure p as a function of temperature t

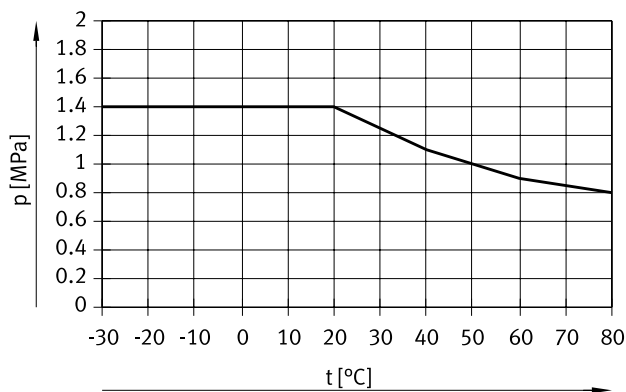

Note

When using the pipe cutter ZR to cut tubing to length, we recommend rotating the tube approx. 90° at the start of the cutting process.

Rotating the tube gives a drawing cut so that the tube can be cut with a significantly lower force. This also minimises deformation of the tube.

Materials

Shore hardness	D 62 ±3
Tubing	TPE-A
Note on materials	RoHS-compliant
LABS (PWIS) conformity	VDMA24364-B2-L

Dimensions and ordering data

O.D. [mm]	I.D. [mm]	Flow-relevant bending radius [mm]	Weight [kg/m]	Colour	Part no.	Type	PU ¹⁾ [m]
22	18	350	0.131	Black	8036207	PAN-R-22x2-SW	50
28	23	350	0.207		8036208	PAN-R-28x2.5-SW	50

1) Packaging unit

Type codes

001	Series	
PAN	Standard O.D. tubing	

002	Alternative material characteristic	
MF	Automotive approval certificate (DIN 73378)	

003	Pipe/tubing O.D. x wall thickness	
4x0,75	4x0.75 mm	
6x1	6x1 mm	
8x1	8x1 mm	
10x1,25	10x1.25 mm	
12x1,5	12x1.5 mm	
14x2	14x2 mm	
16x2	16x2 mm	

004	Colour	
SW	Black	

005	Packaging unit [m]	
	Standard	
500	500 m	

Datasheet

Plastic tubing PAN-MF

High thermal and mechanical load capacities.

Meets the requirements to DIN 73378 "Polyamide tubing for use in motor vehicles".

Material: Polyamide



Operating and environmental conditions

Type	PAN-MF-4	PAN-MF-6	PAN-MF-8	PAN-MF-10	PAN-MF-12	PAN-MF-14	PAN-MF-16	
O.D. [mm]	4	6	8	10	12	14	16	
Pneumatic connection								
For push-in connector [mm]	4	6	8	10	12	14	16	
Temperature-dependent operating pressure	[MPa]	-0.095 ... +3.1 → graph	-0.095 ... +2.7 → graph	-0.095 ... +1.9 → graph			-0.095 ... +2.2 → graph	-0.095 ... +1.9 → graph
	[bar]	-0.95 ... +31	-0.95 ... +27	-0.95 ... +19			-0.95 ... +22	-0.95 ... +19
	[psi]	-13,775 ... +449.5	-13,775 ... +391.5	-13,775 ... +275.5			-13,775 ... +3192	-13,775 ... +275.5
Conforms to	DIN 73378-PA12-PHL							
Operating medium	Compressed air to ISO 8573-1:2010 [7:-:-]							
	Mineral oil							
Ambient temperature [°C]	-60 ... +100							
Tubing characteristics	Suitable for energy chains							

Operating pressure p as a function of temperature t

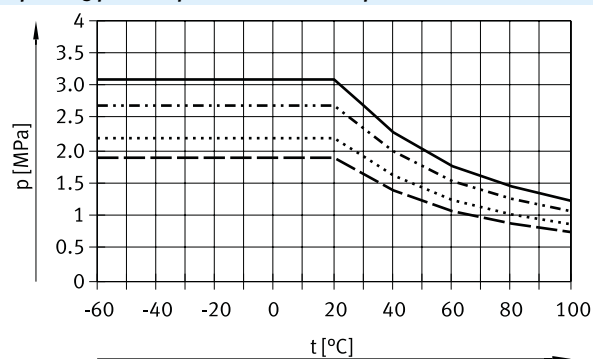

- PAN-MF-4
- PAN-MF-6
- PAN-MF-8/10/12/16
- · - · - PAN-MF-14

Materials

Shore hardness	D 65 ±3
Tubing	PA12-P
Note on materials	RoHS-compliant
LABS (PWIS) conformity	VDMA24364-B2-L

Datasheet

Dimensions – Reel

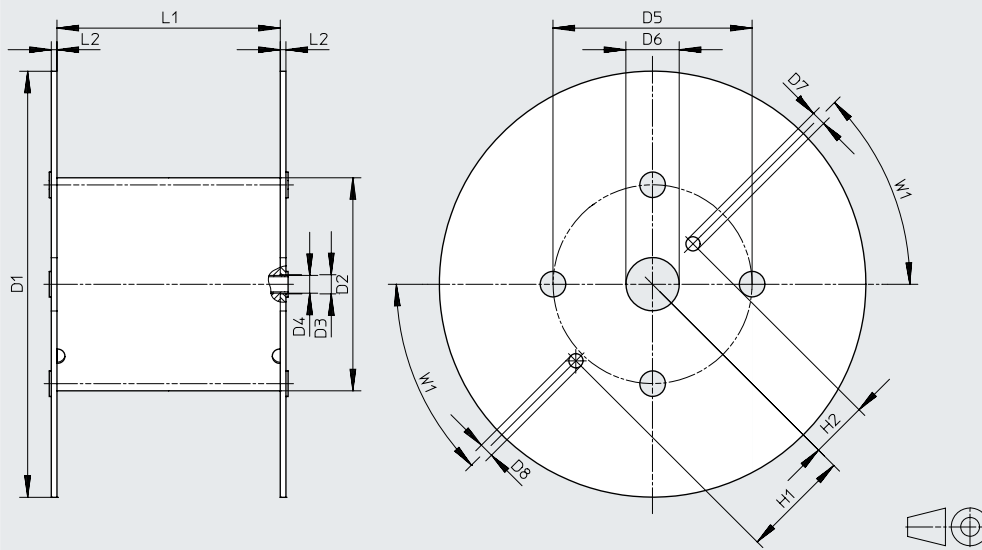

Type	D1 ø	D2 ø	D3 ø	D4 ø	D5 ø	D6 ø	D7 ø	D8 ø	H1	H2	L1	L2	W1
For PAN-MF-4x0.75-...-500	545	246	21	20	216	75	20	20	152.5	80.5	128	8	45°
For PAN-MF-6x1-...-500	600	310	21	20	280	75	20	20	152.5	80.5	114	8	45°

Dimensions and ordering data

O.D. [mm]	I.D. [mm]	Min. bending radius [mm]	Flow-relevant bending radius [mm]	Weight [kg/m]	Colour	Part no.	Type	PU ¹⁾ [m]
4	2.5	10	15	0.008	Black	570357	PAN-MF-4x0.75-SW	50
						572091	PAN-MF-4x0.75-SW-500	500
6	4	15	35	0.016		570358	PAN-MF-6x1-SW	50
						572093	PAN-MF-6x1-SW-500	500
8	6	35	50	0.022		570359	PAN-MF-8x1-SW	50
10	7.5	45	65	0.035		570360	PAN-MF-10x1.25-SW	50
12	9	50	70	0.051		570361	PAN-MF-12x1.5-SW	50
14	10	50	75	0.077		570362	PAN-MF-14x2-SW	50
16	12	75	130	0.09	570363	PAN-MF-16x2-SW	50	

1) Packaging unit

Type codes

001	Series
PAN	Standard O.D. tubing

002	Alternative material characteristic
VO	Flame-retardant

003	Colour
SW	Black
BL	Blue
RT	Red
GN	Green
GE	Yellow
WS	White

Datasheet

Plastic tubing PAN-V0

PVC casing, flame-retardant. The tubing casing must be cut to length X (table → 49) before being inserted in the push-in fitting QS-V0.

The tubing cutter PAN-VOS is the perfect tool for this task. The tubing cutter PAN-VOS will always cut the casing to the right length.

For use in the immediate vicinity of welding applications

Material:
Polyvinyl chloride (outer tubing)
Polyamide (inner tubing)



Operating and environmental conditions

Type	PAN-V0-4	PAN-V0-6	PAN-V0-8	PAN-V0-10	PAN-V0-12
O.D. [mm]	6	8	10	12	14
Pneumatic connection					
For push-in connector [mm]	4	6	8	10	12
Temperature-dependent operating pressure	[MPa]	-0.095 ... +1.2 → graph			
	[bar]	-0.95 ... +12			
	[psi]	-13.775 ... +174			
Operating pressure for entire temperature range	[MPa]	-0.095 ... +0.3			
	[bar]	-0.95 ... +3			
	[psi]	-13.775 ... +43.5			
Note on operating pressure	Mineral oil: max. 0.3 MPa, max. 90°C Water: max. 0.3 MPa at max. 90°C				
Operating medium	Compressed air to ISO 8573-1:2010 [7:::] Mineral oil Water (liquid, ice-free)				
Ambient temperature [°C]	-30 ... +90				
Material fire test	UL94 V-0 (casing)				
Tubing characteristics	Suitable for energy chains				

Operating pressure p as a function of temperature t

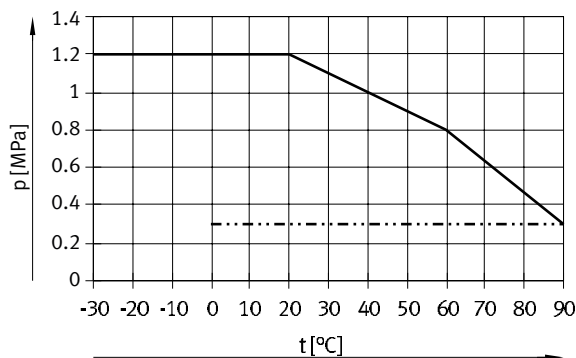

— Air
- - - - - Water and mineral oil

Materials

Shore hardness	Outside tubing	A 72 ±4
	Inside tubing	D 57 ±3
Tubing	Outside tubing	PVC-P
	Inside tubing	PA12-P
Note on materials	RoHS-compliant	
LABS (PWIS) conformity	VDMA24364-B2-L	

Datasheet

Dimensions and ordering data

O.D.	O.D. for push-in fittings	I.D.	Min. bending radius	Flow-relevant bending radius	Max. cut length X	Weight	Colour	Part no.	Type	PJ ¹⁾
[mm]	[mm]	[mm]	[mm]	[mm]	[mm]	[kg/m]				[m]
6	4	2.5	10	20	15	0.0335	Blue	132899	PAN-V0-4x0.75-BL	50
8	6	4	13	30	17	0.049	Black	160550	PAN-V0-6x1-SW	50
							Blue	132905	PAN-V0-6x1-BL	50
							Green	525470	PAN-V0-6x1-GN	50
							Red	525474	PAN-V0-6x1-RT	50
							White	525478	PAN-V0-6x1-WS	50
							Yellow	525482	PAN-V0-6x1-GE	50
10	8	6	24	45	18	0.065	Black	160551	PAN-V0-8x1-SW	50
							Blue	132906	PAN-V0-8x1-BL	50
							Green	525471	PAN-V0-8x1-GN	50
							Red	525475	PAN-V0-8x1-RT	50
							White	525479	PAN-V0-8x1-WS	50
							Yellow	525483	PAN-V0-8x1-GE	50
12	10	7.5	34	56	20	0.088	Black	160552	PAN-V0-10x1.25-SW	50
							Blue	132907	PAN-V0-10x1.25-BL	50
							Green	525472	PAN-V0-10x1.25-GN	50
							Red	525476	PAN-V0-10x1.25-RT	50
							White	525480	PAN-V0-10x1.25-WS	50
							Yellow	525484	PAN-V0-10x1.25-GE	50
14	12	9	43	65	23	0.133	Black	160553	PAN-V0-12x1.5-SW	50
							Blue	525469	PAN-V0-12x1.5-BL	50
							Green	525473	PAN-V0-12x1.5-GN	50
							Red	525477	PAN-V0-12x1.5-RT	50
							White	525481	PAN-V0-12x1.5-WS	50
							Yellow	525485	PAN-V0-12x1.5-GE	50

1) Packaging unit

Ordering data – Modular product system

Ordering table (minimum order quantity 3000 m, rounded value 25 m)											
Size	4	6	8	10	12	14	16	Conditions	Code	Enter code	
Module no.	553610										
Function	Polyamide tubing, standard O.D.								PAN	PAN	
Alternative material characteristic	Standard										
	Automotive certification (DIN 73378)								-MF		
	Sturdy								-R		
Tubing O.D. [mm]	4	–	–	–	–	–	–		-4		
	–	6	–	–	–	–	–		-6		
	–	–	8	–	–	–	–		-8		
	–	–	–	10	–	–	–		-10		
	–	–	–	–	12	–	–		-12		
	–	–	–	–	–	14	–		-14		
	–	–	–	–	–	–	16		-16		
Colour	Silver								-SI		
	Blue								-BL		
	Black								-SW		
	Yellow								-GE		
	Green								-GN		
	Red								-RT		
	Brown								-BR		
	White								-WS		
Natural								-NT			
Labelling text (on request)	Standard										
	Customer-specific tubing inscription								[1]	-TXT	
Packaging unit [m]	25									-25	
	50									-50	
	100						–		-100		
	200					–	–		-200		
	300				–	–	–		-300		
	400			–	–	–	–		-400		
	500		–	–	–	–	–		-500		
Packaging	Cardboard box								[2]	-CB	
	Reel								[3]	-HA	

[1] TXT Only on request
 [2] CB Only with packaging unit 25, 50
 [3] HA Not with packaging unit 25, 50

Type codes

001	Series
PFAN	Plastic tubing

003	Colour
NT	Natural

002	Pipe/tubing O.D. x wall thickness
3x0,5	3x0.5 mm
4x0,75	4x0.75 mm
6x1	6x1 mm
8x1,25	8x1.25 mm
10x1,5	10x1.5 mm
12x1,75	12x1.75 mm

Datasheet

Plastic tubing PFAN

Pneumatic tubing with resistance to high temperatures and chemicals.

Suitable for contact with food.

Material: Perfluoroalkoxy alkane



Operating and environmental conditions

Type		PFAN-3	PFAN-4	PFAN-6	PFAN-8	PFAN-10	PFAN-12
O.D.	[mm]	3	4	6	8	10	12
Pneumatic connection							
For push-in connector	[mm]	3	4	6	8	10	12
For barbed connector	[mm]	2	3	4	6	–	–
For barbed connector with union nut	[mm]	–	3	4	6	–	–
Temperature-dependent operating pressure	[MPa]	–0.095 ... +1.5 → graph		–0.095 ... +1.6 → graph	–0.095 ... +1.5 → graph	–0.095 ... +1.6 → graph	
	[bar]	–0.95 ... +15		–0.95 ... +16	–0.95 ... +15	–0.95 ... +16	
	[psi]	–13.775 ... + 217.5		–13.775 ... +232	–13.775 ... +217.5	–13.775 ... + 232	
Operating pressure for full temperature range	[MPa]	–0.095 ... +0.6		–0.095 ... +0.7	–0.095 ... +0.6	–0.095 ... +0.7	
	[bar]	–0.095 ... +6		–0.095 ... +7	–0.095 ... +6	–0.095 ... +7	
	[psi]	–13.775 ... + 87		–13.775 ... +101.5	–13.775 ... +87	–13.775 ... +101.5	
Note on operating pressure		Water: 0 ... 0.6 MPa, 0 ... 6 bar, 0 ... 87 psi Steam: 0 ... 0.15 MPa, 0 ... 1.5 bar, 0 ... 22 psi					
Operating medium		Compressed air to ISO 8573-1:2010 [7:-:-]					
		Water (liquid, ice-free) ¹⁾					
		Steam ¹⁾					
Note on temperature of medium		Steam: max. 120 °C					
Ambient temperature	[°C]	–20 ... +150					
Food-safe		See supplementary material information ¹⁾					
		See declaration of conformity ¹⁾					
Material fire test		UL94 V-0					

1) More information www.festo.com/catalogue/pfan → Support/Downloads.

Operating pressure p as a function of temperature t

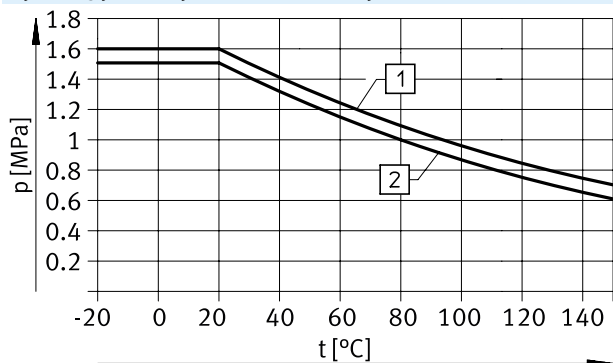

[1] PFAN-6/10/12

[2] PFAN-3/4/8

Datasheet

Materials

Shore hardness	D 60 +5
Tubing	PFA
Note on materials	RoHS-compliant
LABS (PWIS) conformity	VDMA24364-B2-L
Application information	Tubing without printing

Dimensions and ordering data

O.D. [mm]	I.D. [mm]	Min. bending radius [mm]	Flow-relevant bending radius [mm]	Weight [kg/m]	Colour	Part no.	Type	PJ ¹⁾ [m]
3	2.3	10	30	0.0075	Natural	8061167	PFAN-3x0.5-NT	1 ... 50
4	2.9	11	37	0.012		197061	PFAN-4x0.75-NT	1 ... 50
6	4	12	50	0.034		197062	PFAN-6x1-NT	1 ... 50
8	5.9	25	110	0.049		197063	PFAN-8x1.25-NT	1 ... 50
10	7	22	140	0.087		197064	PFAN-10x1.5-NT	1 ... 50
12	8.4	29	165	0.125		197065	PFAN-12x1.75-NT	1 ... 50

1) Packaging unit

Can only be ordered by the metre.

Variable lengths not available in all countries.

Type codes

001	Series
PTFEN	Plastic tubing, polytetrafluorethylene, standard O.D.

002	Pipe/tubing O.D. x wall thickness
4x0,5	4x0.5 mm
6x1	6x1 mm
8x1	8x1 mm
10x1,5	10x1.5 mm
12x2	12x2 mm
14x2	14x2 mm
16x2,5	16x2.5 mm

003	Colour
NT	Natural

004	Packaging unit [m]
	Standard
25	1 m ... 25 m
100	100 m
300	300 m
400	400 m
500	500 m

Datasheet

Plastic tubing PTFEN

Pneumatic tubing with resistance to high temperatures and chemicals.

Material: Polytetrafluoroethylene



Operating and environmental conditions

Type		PTFEN-4	PTFEN-6	PTFEN-8	PTFEN-10	PTFEN-12	PTFEN-14	PTFEN-16
O.D.	[mm]	4	6	8	10	12	14	16
Pneumatic connection								
	For push-in connector [mm]	4	6	8	10	12	14	16
	For barbed connector [mm]	3	4	6	–	–	–	–
	For barbed connector with union nut [mm]	3	4	6	–	–	–	–
Temperature-dependent operating pressure	[MPa]	–0.095 ... +1.2 → graph	–0.095 ... +1.5 → graph	–0.95 ... +1.2 → graph				
	[bar]	–0.95 ... +12	–0.95 ... +15	–0.95 ... +12				
	[psi]	–13.775 ... +174	–13.775 ... +217.5	–13.775 ... +174				
Operating pressure for full temperature range	[MPa]	–0.095 ... +0.5						
	[bar]	–0.95 ... +5						
	[psi]	–13.775 ... +72.5						
Operating medium		Compressed air to ISO 8573-1:2010 [7:--]						
Ambient temperature	[°C]	–20 ... +150						
Food-safe ¹⁾		See supplementary material information						
Material fire test		UL94 V-0						

1) More information: www.festo.com/catalogue/ptfen → Support/Downloads.

Operating pressure p as a function of temperature t

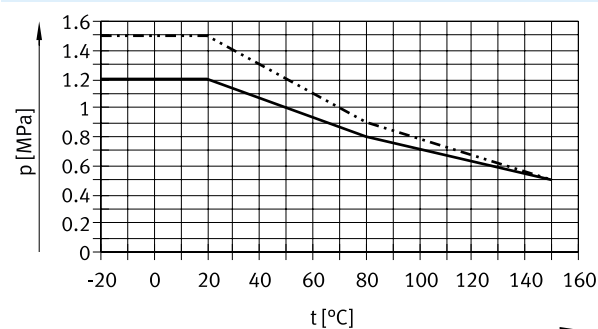

— PTFEN-4/8/10/12/14/16

- - - - - PTFEN-6

Materials

Shore hardness	D 55 ±5
Tubing	PTFE
Note on materials	RoHS-compliant
LABS (PWIS) conformity	VDMA24364-B1/B2-L
Application information	Tubing without printing

Datasheet

Ordering data

O.D. [mm]	I.D. [mm]	Min. bending radius [mm]	Flow-relevant bending radius [mm]	Weight [kg/m]	Colour	Part no.	Type	PU ¹⁾ [m]
4	2.9	32	32	0.013	Natural	8061171	PTFEN-4X0.5-NT-100	100
6	4	38	40	0.034		8061172	PTFEN-6X1-NT-100	100
						8061178	PTFEN-6X1-NT-500	500
8	5.9	64	90	0.047		8061173	PTFEN-8X1-NT	1 ... 50
						8061179	PTFEN-8X1-NT-400	400
10	7	70	100	0.086		8061174	PTFEN-10X1.5-NT	1 ... 50
						8061180	PTFEN-10X1.5-NT-300	300
12	8.4	84	120	0.124		8061175	PTFEN-12X2-NT	1 ... 50
14	10	106	120	0.162		8061176	PTFEN-14X2-NT	1 ... 50
16	11	109	160	0.228		8061177	PTFEN-16X2.5-NT-25	1 ... 25

1) Packaging unit

Can only be ordered by the metre.

Variable lengths not available in all countries.

 - Note

Do not bend tubing!

It is crucial that during assembly and operation the tubing is not bent or excessively constricted when using cable binders.

This could damage the tubing and cause it to split at the bend after a short while under normal operating conditions.

Type codes

001	Series
PEN	Plastic tubing

002	Pipe/tubing O.D. x wall thickness
4x0,75	4x0.75 mm
6x1	6x1 mm
8x1,25	8x1.25 mm
10x1,5	10x1.5 mm
12x1,75	12x1.75 mm
14x2	14x2 mm
16x2,5	16x2.5 mm

003	Colour
NT	Natural
SW	Black
BL	Blue
SI	Silver
RT	Red
GN	Green
GE	Yellow

004	Packaging unit [m]
	Standard
100	100 m
200	200 m
300	300 m
400	400 m
500	500 m

Datasheet

Plastic tubing PEN

Polyethylene tubing is characterised by good resistance to chemicals and hydrolysis. It is resistant to most cleaning agents and lubricants.

Material: Polyethylene



Operating and environmental conditions

Type		PEN-4	PEN-6	PEN-8	PEN-10	PEN-12	PEN-14	PEN-16
O.D.	[mm]	4	6	8	10	12	14	16
Pneumatic connection								
	For push-in connector [mm]	4	6	8	10	12	14	16
	For barbed connector [mm]	3	4	6	–	–	–	–
	For barbed connector with union nut [mm]	3	4	6	–	–	–	–
Temperature-dependent operating pressure	[MPa]	–0.095 ... +1 → graph						
	[bar]	–0.95 ... +10						
	[psi]	–13,775 ... +145						
Operating medium		Compressed air to ISO 8573-1:2010 [7:-:-]						
		Water as per manufacturer's declaration ¹⁾						
Ambient temperature	[°C]	–30 ... +60						
Certification		German Technical Control Board (TÜV)						
Certificate-issuing authority		B 013277 0506 00						
Tubing characteristics		Suitable for energy chains						

1) More information: www.festo.com/catalogue/pen → Support/Downloads.

Operating pressure p as a function of temperature t

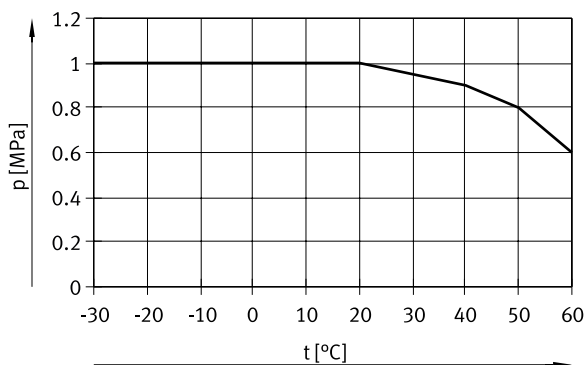

Materials

Shore hardness	D 52 ±3
Tubing	PE
Note on materials	RoHS-compliant
LABS (PWIS) conformity	VDMA24364-B2-L

Datasheet

Dimensions – Reel

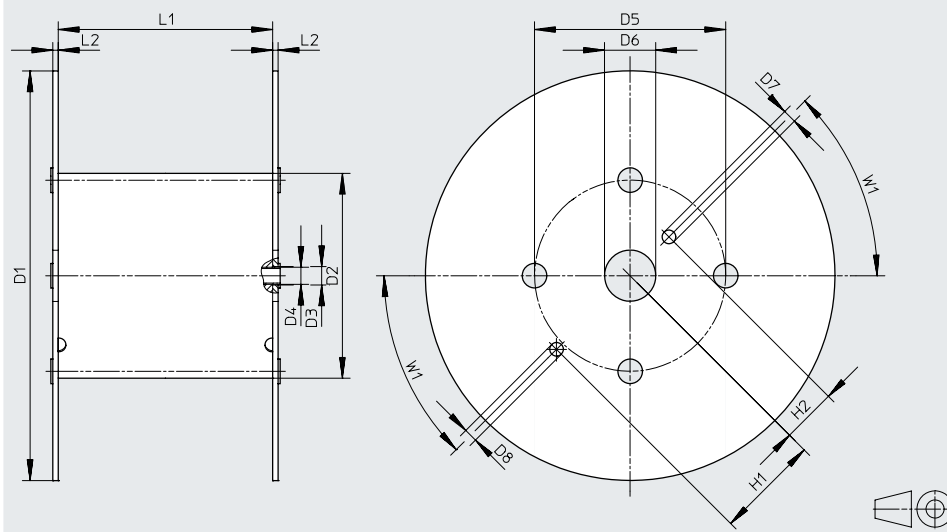

Type	D1 ø	D2 ø	D3 ø	D4 ø	D5 ø	D6 ø	D7 ø	D8 ø	H1	H2	L1	L2	W1
For PEN-4x0.75-...-500	545	246	21	20	216	75	20	20	152.5	80.5	128	8	45°
For PEN-6x1-...-500	545	246	21	20	216	75	20	20	152.5	80.5	128	8	45°
For PEN-8x1.25-...-400	545	310	21	20	280	75	20	20	152.5	80.5	254	8	45°
For PEN-10x1.5-...-300	600	310	21	20	280	75	20	20	152.5	80.5	254	8	45°
For PEN-12x1.75-...-200	600	310	21	20	280	75	20	20	152.5	80.5	254	8	45°
For PEN-16x2.5-...-100	545	310	21	20	280	75	20	20	152.5	80.5	254	8	45°

Dimensions and ordering data

O.D. [mm]	I.D. [mm]	Min. bending radius [mm]	Flow-relevant bending radius [mm]	Weight [kg/m]	Colour	Part no.	Type	PJ ¹⁾ [m]
4	2.7	10	20	0.0064	Black	543240	PEN-4x0.75-SW	50
					Black	551438	PEN-4x0.75-SW-500	500
					Blue	551456	PEN-4x0.75-BL	50
					Blue	551444	PEN-4x0.75-BL-500	500
					Silver	551462	PEN-4x0.75-SI	50
					Silver	551450	PEN-4x0.75-SI-500	500
					Natural	543246	PEN-4x0.75-NT	50
					Green	551468	PEN-4x0.75-GN	50
					Red	551474	PEN-4x0.75-RT	50
6	4	13.5	26	0.0148	Black	543241	PEN-6x1-SW	50
					Black	551439	PEN-6x1-SW-500	500
					Blue	551457	PEN-6x1-BL	50
					Blue	551445	PEN-6x1-BL-500	500
					Silver	551463	PEN-6x1-SI	50
					Silver	551451	PEN-6x1-SI-500	500
					Natural	543247	PEN-6x1-NT	50
					Green	551469	PEN-6x1-GN	50
					Red	551475	PEN-6x1-RT	50
Yellow	551481	PEN-6x1-GE	50					

1) Packaging unit

Datasheet

Dimensions and ordering data								
O.D.	I.D.	Min. bending radius	Flow-relevant bending radius	Weight	Colour	Part no.	Type	PU ¹⁾
[mm]	[mm]	[mm]	[mm]	[kg/m]				[m]
8	5.7	22.5	35	0.0233	Black	543242	PEN-8x1.25-SW	50
					Black	551440	PEN-8x1.25-SW-400	400
					Blue	551458	PEN-8x1.25-BL	50
					Blue	551446	PEN-8x1.25-BL-400	400
					Silver	551464	PEN-8x1.25-SI	50
					Silver	551452	PEN-8x1.25-SI-400	400
					Natural	543248	PEN-8x1.25-NT	50
					Green	551470	PEN-8x1.25-GN	50
					Red	551476	PEN-8x1.25-RT	50
					Yellow	551482	PEN-8x1.25-GE	50
10	7	23.5	40	0.0377	Black	543243	PEN-10x1.5-SW	50
					Black	551441	PEN-10x1.5-SW-300	300
					Blue	551459	PEN-10x1.5-BL	50
					Blue	551447	PEN-10x1.5-BL-300	300
					Silver	551465	PEN-10x1.5-SI	50
					Silver	551453	PEN-10x1.5-SI-300	300
					Natural	543249	PEN-10x1.5-NT	50
					Green	551471	PEN-10x1.5-GN	50
					Red	551477	PEN-10x1.5-RT	50
					Yellow	551483	PEN-10x1.5-GE	50
12	8.4	33	58	0.0542	Black	543244	PEN-12x1.75-SW	50
					Black	551442	PEN-12x1.75-SW-200	200
					Blue	551460	PEN-12x1.75-BL	50
					Blue	551448	PEN-12x1.75-BL-200	200
					Silver	551466	PEN-12x1.75-SI	50
					Silver	551454	PEN-12x1.75-SI-200	200
					Natural	543250	PEN-12x1.75-NT	50
					Green	551472	PEN-12x1.75-GN	50
					Red	551478	PEN-12x1.75-RT	50
					Yellow	551484	PEN-12x1.75-GE	50
14	9.5	45	80	0.0773	Black	570516	PEN-14x2-SW	50
					Natural	570517	PEN-14x2-NT	50
16	10.8	57.5	122	0.1029	Black	543245	PEN-16x2.5-SW	50
					Black	551443	PEN-16x2.5-SW-100	100
					Blue	551461	PEN-16x2.5-BL	50
					Blue	551449	PEN-16x2.5-BL-100	100
					Silver	551467	PEN-16x2.5-SI	50
					Silver	551455	PEN-16x2.5-SI-100	100
					Natural	543251	PEN-16x2.5-NT	50
					Green	551473	PEN-16x2.5-GN	50
					Red	551479	PEN-16x2.5-RT	50
					Yellow	551485	PEN-16x2.5-GE	50

1) Packaging unit

Ordering data – Modular product system

Ordering table (minimum order quantity 3000 m, rounded value 25 m)											
Size	4	6	8	10	12	14	16	Conditions	Code	Enter code	
Module no.	553769										
Function	Polyethylene tubing, standard O.D., economical								PEN	PEN	
Tubing O.D. [mm]	4	–	–	–	–	–	–		-4		
	–	6	–	–	–	–	–		-6		
	–	–	8	–	–	–	–		-8		
	–	–	–	10	–	–	–		-10		
	–	–	–	–	12	–	–		-12		
	–	–	–	–	–	14	–		-14		
	–	–	–	–	–	–	16		-16		
Colour	Silver								-SI		
	Blue								-BL		
	Black								-SW		
	Yellow								-GE		
	Green								-GN		
	Red								-RT		
	Brown								-BR		
	White								-WS		
	Natural								-NT		
Labelling text (on request)	Standard										
	Customer-specific tubing inscription							[1]		-TXT	
Packaging unit [m]	25									-25	
	50									-50	
	100									-100	
	200					–	–		-200		
	300				–	–	–		-300		
	400			–	–	–	–		-400		
	500		–	–	–	–	–		-500		
Packaging	Cardboard box							[2]		-CB	
	Reel							[3]		-HA	

- [1] TXT Only on request
 [2] CB Only with packaging unit 25, 50
 [3] HA Not with packaging unit 25, 50

Type codes

001	Series
PLN	Plastic tubing, polyethylene, standard O.D.

002	Pipe/tubing O.D. x wall thickness
4x0,75	4x0.75 mm
6x1	6x1 mm
8x1,25	8x1.25 mm
10x1,5	10x1.5 mm
12x1,75	12x1.75 mm
14x2	14x2 mm
16x2	16x2 mm

003	Colour
NT	Natural
SW	Black
BL	Blue
SI	Silver
RT	Red

Datasheet

Plastic tubing PLN

Polyethylene tubing is characterised by good resistance to chemicals and hydrolysis. It is resistant to most cleaning agents and lubricants.

Material: Polyethylene



Operating and environmental conditions

Type		PLN-4	PLN-6	PLN-8	PLN-10	PLN-12	PLN-14	PLN-16	
O.D.	[mm]	4	6	8	10	12	14	16	
Pneumatic connection									
	For push-in connector	[mm]	4	6	8	10	12	14	16
	For barbed connector	[mm]	3	4	6	–	–	–	–
	For barbed connector with union nut	[mm]	3	4	6	–	–	–	–
Temperature-dependent operating pressure	[MPa]	–0.095 ... +1.4 → graph							
	[bar]	–0.95 ... +14							
	[psi]	–13,775 ... +203							
Operating medium	Compressed air to ISO 8573-1:2010 [7:-:-]								
	Water as per manufacturer's declaration ¹⁾								
Ambient temperature	[°C]	–30 ... +80							
Food-safe ¹⁾	See supplementary material information								
Certification	German Technical Control Board (TÜV)								
Certificate-issuing authority	B 013277 0506 00								

1) More information: www.festo.com/catalogue/pln → Support/Downloads.

Operating pressure p as a function of temperature t

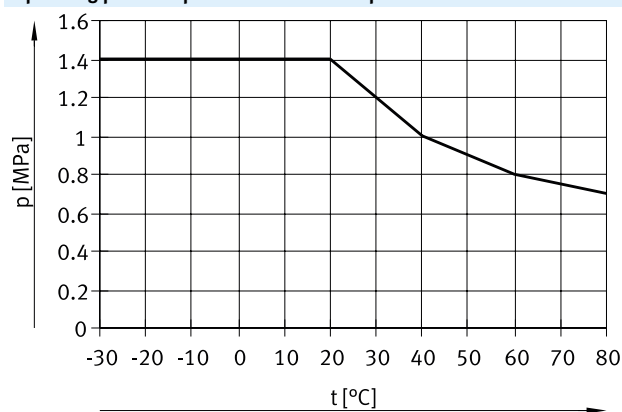

Materials

Shore hardness	D 59 ±3
Tubing	PE
Note on materials	RoHS-compliant
LABS (PWIS) conformity	VDMA24364-B2-L

Datasheet

Dimensions and ordering data								
O.D. [mm]	I.D. [mm]	Min. bending radius [mm]	Flow-relevant bending radius [mm]	Weight [kg/m]	Colour	Part no.	Type	PU ¹⁾ [m]
4	2.9	12	25	0.0056	Natural	193403	PLN-4x0.75-NT	50
					Black	195280	PLN-4x0.75-SW	50
					Blue	558205	PLN-4x0.75-BL	50
					Silver	558211	PLN-4x0.75-SI	50
					Red	558217	PLN-4x0.75-RT	50
6	4	11	32	0.0147	Natural	193404	PLN-6x1-NT	50
					Black	195281	PLN-6x1-SW	50
					Blue	558206	PLN-6x1-BL	50
					Silver	558212	PLN-6x1-SI	50
					Red	558218	PLN-6x1-RT	50
8	5.9	23	50	0.0214	Natural	193405	PLN-8x1.25-NT	50
					Black	195282	PLN-8x1.25-SW	50
					Blue	558207	PLN-8x1.25-BL	50
					Silver	558213	PLN-8x1.25-SI	50
					Red	558219	PLN-8x1.25-RT	50
10	7	22	57	0.0375	Natural	193406	PLN-10x1.5-NT	50
					Black	195283	PLN-10x1.5-SW	50
					Blue	558208	PLN-10x1.5-BL	50
					Silver	558214	PLN-10x1.5-SI	50
					Red	558220	PLN-10x1.5-RT	50
12	8.4	23	65	0.054	Natural	193407	PLN-12x1.75-NT	50
					Black	195284	PLN-12x1.75-SW	50
					Blue	558209	PLN-12x1.75-BL	50
					Silver	558215	PLN-12x1.75-SI	50
					Red	558221	PLN-12x1.75-RT	50
14	10	40	80	0.07	Natural	570424	PLN-14x2-NT	50
					Black	570423	PLN-14x2-SW	50
16	12	55	95	0.082	Natural	539064	PLN-16x2-NT	50
					Black	539065	PLN-16x2-SW	50
					Blue	558210	PLN-16x2-BL	50
					Silver	558216	PLN-16x2-SI	50
					Red	558222	PLN-16x2-RT	50

1) Packaging unit

Ordering data – Modular product system

Ordering table (minimum order quantity 3000 m, rounded value 25 m)											
Size	4	6	8	10	12	14	16	Conditions	Code	Enter code	
Module no.	553850										
Function	Polyethylene tubing, standard O.D., resistant to cleaning agents								PLN	PLN	
Tubing O.D. [mm]	4	–	–	–	–	–	–		-4		
	–	6	–	–	–	–	–		-6		
	–	–	8	–	–	–	–		-8		
	–	–	–	10	–	–	–		-10		
	–	–	–	–	12	–	–		-12		
	–	–	–	–	–	14	–		-14		
	–	–	–	–	–	–	16		-16		
Colour	Silver								-SI		
	Blue								-BL		
	Black								-SW		
	Yellow								-GE		
	Green								-GN		
	Red								-RT		
	Brown								-BR		
	White								-WS		
Natural								-NT			
Labelling text (on request)	Standard										
	Customer-specific tubing inscription							[1]		-TXT	
Packaging unit [m]	25									-25	
	50									-50	
	100									-100	
	200					–	–		-200		
	300				–	–	–		-300		
	400			–	–	–	–		-400		
	500		–	–	–	–	–		-500		
Packaging	Cardboard box							[2]		-CB	
	Reel							[3]		-HA	

- [1] TXT Only on request
 [2] CB Only with packaging unit 25, 50
 [3] HA Not with packaging unit 25, 50