

# TBS CROSSFIRE R/C System

*Adaptive Long Range Remote Control System*

Revision 2020-10-08



The TBS CROSSFIRE (XF) system is a R/C link system made for FPV enthusiasts. It features unheard of range without sacrificing basic functionality such as being immune to interference from onboard equipment, low latency control or two-way communications including telemetry functionality.

## Key features

- Long range, adaptive and robust remote control system for your aircraft
- Immune to on-board noise
- Two-way communication link with real-time link vitals and telemetry
- Self-healing frequency hopping link
- Receiver beacon mode to recover your downed aircraft
- Super easy binding and configuration via built-in OLED display, OpenTX LUA or TBS TANGO remote
- Low latency control for perfect immersive feeling
- Free output mappable outputs diversity
- Ability to fly with multiple friends at the same time (10 or more)
- Dynamic self-selecting or selectable RF power (local restrictions apply)
- Dedicated head-tracking input option for full FPV immersion (Standard/ Lite TX only)
- Transmitter LED shows link health, OLED display for built in configuration (Standard/ Lite TX only)



---

# Table of content

[Attention](#)

[Getting ready](#)

[FAQ](#)

[Note](#)

[Updating](#)

[Hardware overview](#)

[Standard Tx pinout](#)

[Radio connection](#)

[JR-bay radios](#)

[Other radios](#)

[Antennas](#)

[Antenna cover](#)

[Adapter boards](#)

[FrSky inverter mod](#)

[Which transmitter is affected by this?](#)

[How to install the inverter mod](#)

[Software mod](#)

[General functions](#)

[Binding](#)

[General note/ model match](#)

[When do i need to bind again](#)

[Binding issue \(Double green flashing\)](#)

[Transmitter](#)

[Receiver](#)

[Receiver Update \(OTA\)](#)

[Auto Bind](#)

[Multi bind](#)

[How to set it up](#)

[Failsafe setup](#)

[General setup](#)



---

[Cut](#)

[Failsafe position](#)

[Transmission frequency](#)

[Transmission power](#)

[Operating modes](#)

[Transmitter LED status indicator](#)

[Receiver LED status indicator](#)

[MyVTX](#)

[RC over MAVLink](#)

[Special functions - Standard/ Lite TX only](#)

[External power](#)

[Status display](#)

[Up- and downlink status](#)

[Oled Menu](#)

[Find Mode](#)

[Real time telemetry by Bluetooth](#)

[Head-tracking](#)

[Receiver functions](#)

[Output map](#)

[CRSf](#)

[Serial](#)

[SBUS](#)

[N.i. SBUS](#)

[MAVLink](#)

[PWM \(Ch X\)](#)

[PPM](#)

[DSMX](#)

[RSSI](#)

[LQ](#)

[RSSI/LQ](#)

[Smart Audio](#)



---

[Channel number](#)

[RF Profile](#)

[Telemetry](#)

[Available sensors with OpenTX](#)

[Missing sensors](#)

[In-built Voltage monitoring](#)

[Bst connection](#)

[Additional informations](#)

[TBS CLOUD](#)

[Menu](#)

[Initiate the WiFi module](#)

[Connection to a WiFi hotspot](#)

[OTA update of the WiFi Module](#)

[Opentx setup for crossfire](#)

[LQ warning in OpenTX](#)

[Model match in OpenTX \(and FreedomTx on Tango 2\)](#)

[Vtx connection by CRSF](#)

[Vtx connection by SmartAudio](#)

[Smart Audio or CRSF for the VTx?](#)

[VTx button is not working](#)

[Connection to an FC](#)

[General wiring](#)

[CRSF with BetaFlight and similar firmwares](#)

[CRSF with KISS/ FETTEC](#)

[Any other FC](#)

[BST to Eagletree Vector](#)

[Mavlink with MAV FC's](#)

[Wireless configuration with ArduPilot/ PX4 by Bluetooth](#)

[Wireless configuration with ArduPilot/ PX4 by WiFi](#)

[Wireless telemetry](#)

[Bluetooth](#)



---

[WiFi](#)

[WiFi telemetry with BetaFlight/ INav](#)

[Wireless configuration with BetaFlight/ Inav by Bluetooth](#)

[Signal strength in Betaflight - BF < 4.1 and DJI OSD](#)

[Signal strength in Betaflight - BF 4.1 and later](#)

[Signal strength in INav](#)

[Link States](#)

[LQ](#)

[RSSI](#)

[SNR](#)

[Warning levels](#)

[What should i use in my OSD or radio](#)

[Racing environment](#)

[Factory reset](#)

[Emergency Update](#)

[FLARM](#)

[What you need](#)

[Getting a license](#)

[Activation of a license](#)

[Status display](#)

[Settings](#)

[OSD](#)

[Flarm in action](#)

[FAQ](#)



## Specifications

<b>Type:</b>	Long Range Two-Way Remote Control System
<b>Band:</b>	Europe: 868 MHz SRD Band America: 915 MHz ISM Band
<b>RF power Radio Signal &amp; Telemetry downlink:</b>	Micro TX V1: Selectable 25mW to 250mW Micro TX V2: Selectable 25mW to 1W Standard/ Lite TX: Selectable 10mW to 2W Diversity, Micro and Nano RX: 40mW
<b>Receiver sensitivity:</b>	Up to -130dBm
<b>Antenna:</b>	TX: 1x omnidirectional dipole antenna RX: depends on the receiver type (U.fl or SMA)
<b>R/C Channels:</b>	8 (Diversity/ nano Diversity)/ 4(6) (Micro/Nano RX) PWM (freely mappable ) or up to 12-channel PPM stream outputs, standard 2.54mm servo connectors
<b>Radio compatibility:</b>	Any radio with PPM stream output (Standard/ Lite Tx only) Any radio with JR-style bay. OpenTX recommended
<b>Interface:</b>	Micro TX: RGB LED light, push button, configuration via CRSF (TBS TANGO, OpenTX ect. ), WiFi Standard TX: 1.3-inch OLED display and joystick for configuration, binding and link stats, Bluetooth, WiFi
<b>Recovery mode:</b>	(Nano) Diversity RX: Beacon-mode, receiver backup LiPo battery - operating time of approx. 2 days
<b>Failsafe:</b>	Pre-set servo positions or stops outputting servo pulse - selectable in configuration menu or via push button
<b>Antenna connector:</b>	TX: Standard SMA, Standard Diversity rx: RP-SMA, U.fl (Micro/ Nano receiver)
<b>Operating range:</b>	Variable depending on output power and radio environment
<b>Input power:</b>	TX: +3.5 to 12.6V via RC or HT 3-pin input connector, External 2S to 3S LiPo via XT30 connector (standard RX only) Diversity RX: +4.5V to 8.4V Nano Rx's: +4.5V to 8.4V (down to 3.3V possible, but not recommended) All reverse-polarity protected, compatible for 2s Lipo direct
<b>Power consumption:</b>	TX: 1.1W, at 25mW TX: 3.2W, at 2000mW Diversity RX: 1.5W / Micro/Nano RX: 1W
<b>Ports:</b>	Diversity RX: 1x BST (the CROSSFIRE RX does not power the BST line), 8x Servo connectors Micro RX: V1: 1x Servo, 1x BST / V2: 4x Servo, 1x BST - Nano RX: 2x Pin-headers for 1x BST and 4x Servo Nano Div. Rx: 2x Pin-headers for 1x BST and 8x Servo
<b>Working temperature:</b>	0 - 40°C
<b>Size:</b>	Standard TX: 150 x 80 x 20 mm, Micro TX: 73 x 56 x 35 mm Diversity RX: 30 x 50 x 12 mm, Micro RX: 40 x 14 x 9.5mm
<b>Weight:</b>	Micro TX: 38g, Standard TX: 340g, Diversity RX: 25 grams, Micro RX: 3.2 grams



---

## Attention

These Long Range Systems are capable of radio frequency transmissions and output power that may be not allowed in your country.

**Please always check your local RF legislation to set the frequency and output power according to the regulation.**

A general rule for RC aircrafts is that they must be controlled always under sight of view, check your RC regulation to keep up to date with regulations.

## Getting ready

Getting set up and ready to fly is a quick and simple task. In most cases plug&play when using TBS equipment.

## FAQ

If you got any question after reading this manual you should visit the [TBS FAQ](#) section

## Note

This manual is written based on *Crossfire FW 4.00*. If some functions are not available for you, please update your Crossfire to this (Beta) or a later version.

## Updating

In order to update and configure your Crossfire, you need the TBS Agent X, which you can download from the [TBS shop](#).

To update your Crossfire, connect it by the USB-port of the transmitter and run the update by Agent X.

The receiver will then get the update while the next binding (details can be found in the [receiver update section](#))

For detailed instructions on how to use the Agent X, have a look at the [Agent X manual](#).



# Hardware overview

The following diagram indicates the essential inputs and features of the transmitters and receivers.

## Standard/ Lite transmitter module:



## Diversity receiver unit:

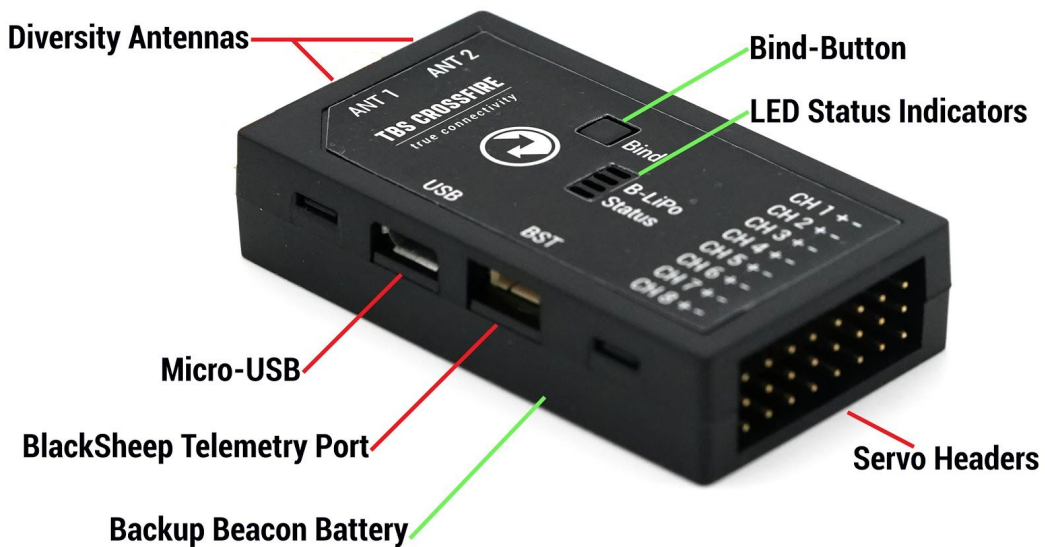



**Micro transmitter module (V1 + V2):**



*The Micro Tx V2 has the same features and layout as the V1 but with a USB-C connector*

**Nano transmitter module :**



*The Nano transmitter includes the same internals and functions as the Micro Tx V2. It is designed to fit into the mini-modul bay of newer FrSky radios, Tango 2 modul bay and any other radio with the mini-modul bay.*

**If you already own a Micro Tx V2 you can get a retro-fit set to change the housing from JR-style to Mini modul style. The internals remain the same. [Get yours at TBS](#)**



**Micro receiver:**

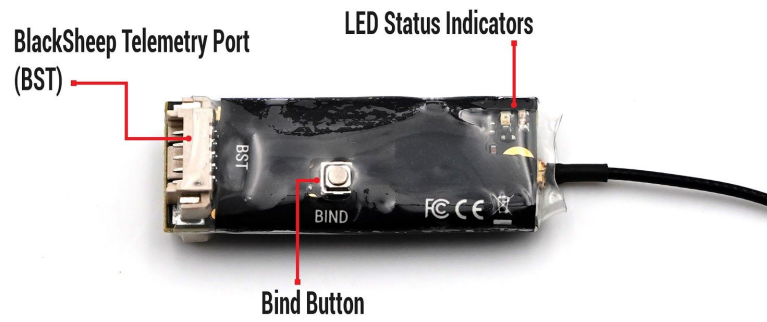

**Nano receiver:**

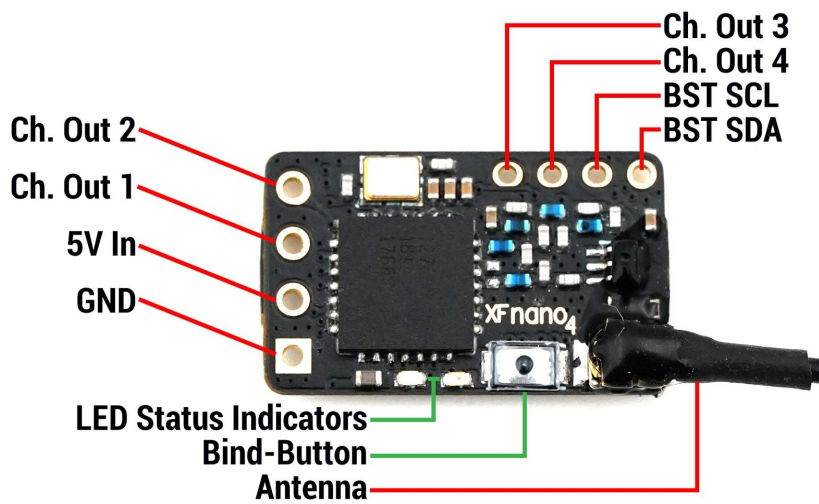

### Nano receiver pwm version:

This Rx is the same as the Nano Rx but with 6 servo connectors installed. This Saves you the need for the PWM adapter board.



### Nano Diversity rx:

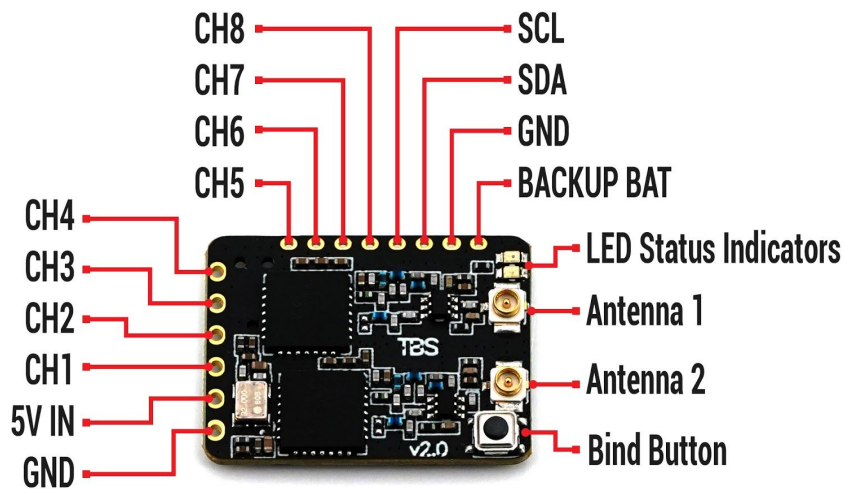

### Standard Tx pinout



---

## Radio connection

### JR-bay radios

If you use a radio with standard jr-bay style module bay, you can easily plug the Crossfire transmitters into them.



### JR-bay issue

When you have set up everything properly in OpenTX but your module still stays off, the radio pins did not slide into the Crossfire Tx. In this case you can bend all the pins in the JR bay just a little bit to the right or left side and plug the module bag in.



---

## Other radios

If you own a radio without a JR-bay, you need to use the Standard/ Lite transmitter with their input pins for many trainer-port connectors, which you then connect to the RC In plug.

*Note: over this connection you can not use CRSF between your radio and the Crossfire Tx. If your radio supports CRSF, you need to feed the signal wire in the plug on the right. Check the Tx [pinout](#) for details.*

### Hitec/Graupner/JR-cable



### Futaba-cable



### Custom PPM cable



---

## Antennas

You got a big variety of antennas for your transmitter and receiver. The antennas that come with your devices work fine and don't need to be replaced in general. Depending on your environment, your drone and your purpose, you can change them anyway. Here are some of them:



Flexible antenna



MicroVee antenna

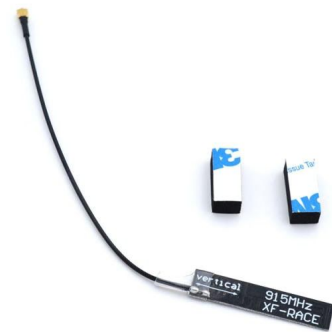

PCB Race antenna

Other antennas can be found at the [TBS webshop](#) or on [VideoAerialSystems](#).



---

## Antenna cover

If you order your Crossfire transmitter after mid 2020, you will notice a cover over the antenna.

The antenna can be turned by 90° (both directions) to align it with your receiver antenna. If you want to use a different one or just detach it after the flight, you need to unscrew the cover and break it.

This will not void your warranty



---

## Adapter boards

There are many ways of installing the Crossfire Rx into a model like these mounting boards:



On some of them you can connect a Unify Nano32 with the Crossfire receiver and use [the CRSF connection](#) to control the VTx.

## FrSky inverter mod

When you receive your Crossfire transmitter, there is a small inverter chip included. This chip is a hardware mod that you can build into your FrSky radio to use the full communication speed between your radio and the Crossfire Tx as some of them only have a slow transistor instead of an inverter chip included.

This mod is not necessary for the Crossfire to operate properly with your radio but it helps with “Sensor lost” messages on certain radios as well as not properly working LUA scripts.

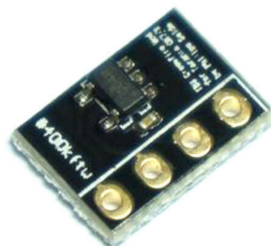

This modification requires a good soldering skill and will void your radios warranty. If you don't feel comfortable with this, use the [software mod](#) instead.





---

## Which transmitter is affected by this?

The older QX7 radio from FrSky with the S-Port pin at the bottom of the radio.

Newer ACCESS radios and older radios than the QX7 (with bottom S-Port pin) don't need this hardware mod.

## How to install the inverter mod

There is a detailed how-to available at [phillip.seidels.blog](http://phillip.seidels.blog)

## Software mod

Instead of installing the hardware mod, you can simply lower the speed on which the radio communicates with your radio.

Navigate in your radio settings to the *Hardware* tab and set the *Max Baud* setting from **400000** to **115000**.

**If your radio is known to not need this soft/ hardware mod, the BaudRate setting is not available**

```
HARDWARE 6/7
RTC Batt 1.28V
Check RTC 
Max bauds 400000
Bluetooth ---
ADC filter 
RAS ---/---
SP Power AUTO
```



---

## General functions

### Binding

Binding a receiver to your Crossfire is an easy task and does not require 3 hands or any special jumpering.

#### General note/ model match

You will notice that you can control any r/c model, even if you changed the model in your radio. This is caused by the fact that the Crossfire does not monitor the radio model. This means you have to make sure that you selected the right model in your radio before you power up the receiver.

If you are used to FrSky, it's the same behavior as when you set your receiver number to 00 in the mode settings (with FrSky receivers)

Model matching with the Crossfire and OpenTX is being tested.

#### When do i need to bind again

There are a few cases when you need to rebind your transmitter to the receiver:

- You changed the region/ frequency setting\*
- You updated your transmitter firmware
- You enabled multi-bind\*
- You did a factory-reset on the receiver

*\* you can avoid a rebind, if you change these settings while the receiver is bound and powered up.*

#### Binding issue (Double green flashing)

If you get a double green flashing pattern on the receiver after updating or binding, you got an authentication error. To solve this issue:

- Shut down the receiver
- Set the Tx in bind mode
- Power up the receiver
- Push the *Bind* button on the Rx

After the binding the pattern may return but should be gone after a few seconds.



---

## Transmitter

First you need to set your transmitter in bind mode. For this you got a variety of options, depending on the radio and transmitter type you use:

### Lua script (OpenTX radio only):

1. Turn on your radio
2. Navigate to the Crossfire lua script and execute it
3. Open the *Crossfire Transmitter*
4. Scroll down to *Bind* and hit enter

### TBS Tango 1:

1. Turn on your radio
2. Hold the rocker switch to enter the main menu
3. Scroll down to *Devices*
4. Under *Crossfire Transmitter*
5. Click on *Bind*

### Agent X:

1. Connect your transmitter to the Agent X by USB
2. Open the Crossfire Transmitter (*Manage*)
3. Navigate to the *Configure* tab
4. Under *Device*, click on *Bind*

### Button (Micro TX):

1. Power up the transmitter
2. Push the button of the Micro TX once

### Oled Display (Standard/ Lite TX):

1. Hold the joystick down till the menu opens up
2. Open the *Crossfire Transmitter*
3. Navigate to *General*
4. Scroll down to *Bind* and click on the joystick



## Receiver

After your transmitter is in bind mode, you need to do the same with the receiver. This procedure is the same for all receiver types available:

1. Power up the receiver
2. Within 1 minute, push the bind button on the receiver

## Receiver Update (OTA)

Depending on the firmware on your transmitter and the receiver, you might need to update your receiver.

With the transmitter and the receiver both in bind mode, you then will get a message on the radio/ Agent X, telling you that the receiver needs to be updated. Follow the instructions shown there. The firmware will be sent to the receiver over the air (OTA). When the transmission is finished, the receiver flashes itself. After this, they are bound and ready to be used.

## Auto Bind

When you update your transmitter firmware, you need to rebind the receiver in order to run the OTA update. In this case, you don't need to hit the bind button on the receiver again, when he was bound before:

1. Power up your transmitter
2. Set it in bind mode
3. Power up the receiver
4. Wait a few seconds
5. Now you should get the update prompt without pressing the receiver bind button again

## Multi bind

Since fw 3.71 you can use all your transmitters on all your receivers without rebinding them each time. This is useful if you own more than one transmitter module or an external module and a Tango II etc.

Make sure you [initiated your WiFi module](#) before!

### How to set it up

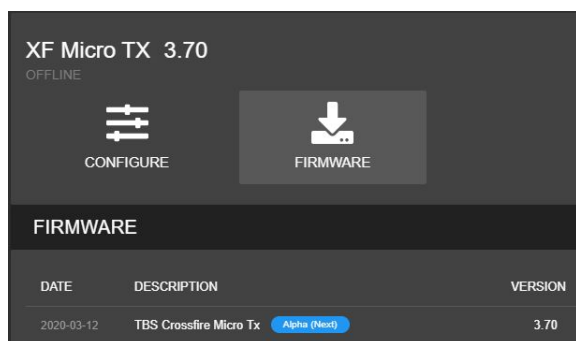

Update your CROSSFIRE TX to FW 3.71 (or later) by Agent X. If you can't see the required FW version, click on the 3 dots in the top right corner and check "include beta releases".

Make sure that the WiFi module is powered up as well (standard tx).





After the update wait for Agent X to synchronize the device with your TBS account. This is done when the dot on the top of the devices turned green

XF Transmitter  
Nano receiver  
XF WiFi

Connect your CROSSFIRE to the internet via the built-in WiFi module. You can provide access point information from your nearest wifi hotspot, or create a temporary one on your phone. Wait for it to switch to "Online" under *XF WIFI/ About*

Firmware: V 3.81  
Hardware V 1.02  
Bootloader V 1.05  
Serial No.: 016-000264  
Rc Input: CRSFShot  
User ID: 12345

After a few seconds you can navigate back to *XF Transmitter/ About*. Now you should see your user id. This user ID will be the unique binding ID. Each transmitter with this user ID can now bind to your receivers on the same firmware version.

Multi-Bind Enable  
Regio Open  
Max Power 25mW  
Dyn. Power On  
Frequency 868MHz  
Op. Mode Nomal  
Bluetooth MAVLink  
Factory Reset

Enable the multi bind option under *XF Transmitter/ General*

Repeat this step for every Crossfire transmitter that you own (e.g. TX module, Tango 2, etc)



## Binding

- If you've got a bound receiver, just bind/ update it with multi-bind turned off and while it's connected turn multi-bind on. Wait for a few seconds, then the link will come back again.
- On a new receiver you can just bind it by the button as usual.
- On the other CROSSFIRE Tx, just enable "Multi-Bind". When the first tx is shut down, you can power up the second transmitter. It should bind to this receiver within a few seconds.

## Disable Multi-Bind

- To disable the multi bind option you just need to set the "*Multi-Bind*" option to "disable". If the link is running, just switch it off and wait a moment till the link regains.
- Otherwise rebind the receiver by the button.

## Wrong ID/new ID

- It may occur that you need a "new" id. To get a new ID, simply connect your Crossfire to the Agent X with the new/correct user account and let it synchronise with the TBS Cloud.
- The next time the WiFi module connects to the internet it will get the new id after a few seconds.

## General note:

Multi bind and [model match](#) does not work together, when the model id is not the same in both radios:

Model Id radio 1		Model Id radio 2
00	✓	00
01	✗	00
03	✗	01
./.	✓	./.
00	✓	./.



---

## Real world example

The most common combination is that you already own a Crossfire transmitter to which all your receivers are bound and now you have a second transmitter like the Tango 2. Here is how you get them both running with Multi Bind, assuming that you already got you user id on both transmitters:

1. Make sure both radios got the same firmware version
2. Power up your "old" transmitter and make sure Multi Bind is turned off for now
3. Power up the receiver - if you updated this transmitter, run the OTA update by the autobind feature
4. Turn Multi Bind *on* - the link will break up for 1 or 2 seconds and will be regained then
5. Shut down the receiver
6. Turn Multi Bind *off* in your "old" transmitter
7. Power up the next receiver
8. Repeat step 4 till all your receivers are switched to multi bind
9. When the last receiver is set to Multi Bind, let it enabled in your "old" transmitter
10. Power you new Transmitter
11. Turn Multi Bind *on*
12. Power up a receiver - your new transmitter will bind to your receiver as the old transmitter did

If the switching fails, you can turn on multi bind on your transmitter and then bind the receiver with the *Bind* button (classic binding).

Keep in mind that when you use the Model Id (FreedomTx)/ Receiver number (OpenTx) feature that they need to match in both radios!

## Nice to know

When you bind a new receiver, it will remember the serial number of the transmitter it was bound. As an example your serials number looks like this: *123456*

When the Model ID/ receiver number feature was introduced, these numbers got attached to the serial number: *123456 00*. (with Model id = 05: *123456-05*)

When you enable Multi Bind, the serial number of the transmitter will not be used. Instead the receiver gets your user id as "transmitter serial number" which looks like this: *12345 (+ model id)*

As all of your transmitters share the same User Id they are like the same transmitter for your receiver.



---

## Failsafe setup

The TBS Crossfire supports two failsafe behaviors: cut and failsafe position. Setting them up correctly is crucial for the safety of your model.

### General setup

The failsafe setting is located in the receivers menu. To change the behavior:

1. Navigate in the receiver menu by your radio/ Lua script/ Agent X
2. Open the General menu
3. Change the FS. Mode setting to what you need it to be

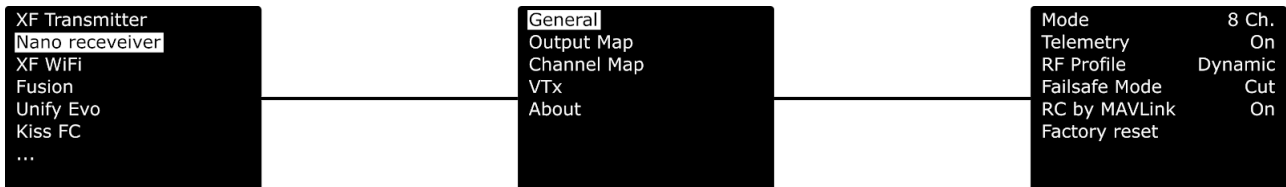

### Cut

This is the setting that you need to use if you got a flight controller in your aircraft, that handles a failsafe routine like RTh for you. If the link breaks up, the receiver will output no signal, which will be detected by your fc.

### Failsafe position

If you use a model without fc or with a fc that requires a special stick position (e.g. DJI NAZA), failsafe-position is what you need.

With this setting, the receiver will output a previously taught position for all channels.

#### Important:

*If you have set up failsafe position and did not teach a position afterwards, the receiver will output the last position before the link broke up.*

#### Teaching a position

*This may require the help of a second person, as it can be tricky to hold the sticks and hit the teach button.*

1. Power up your bound receiver and your radio with the crossfire transmitter in it
2. Open your *transmitter* menu
3. Hold the sticks and switches in the position you want them to be in a failsafe situation
4. Click on *Set fs. Mode* and wait for the confirmation for the set position

If your failsafe setting was set to cut and you entered the teaching mode, the crossfire will change the type to position if you accept the request.





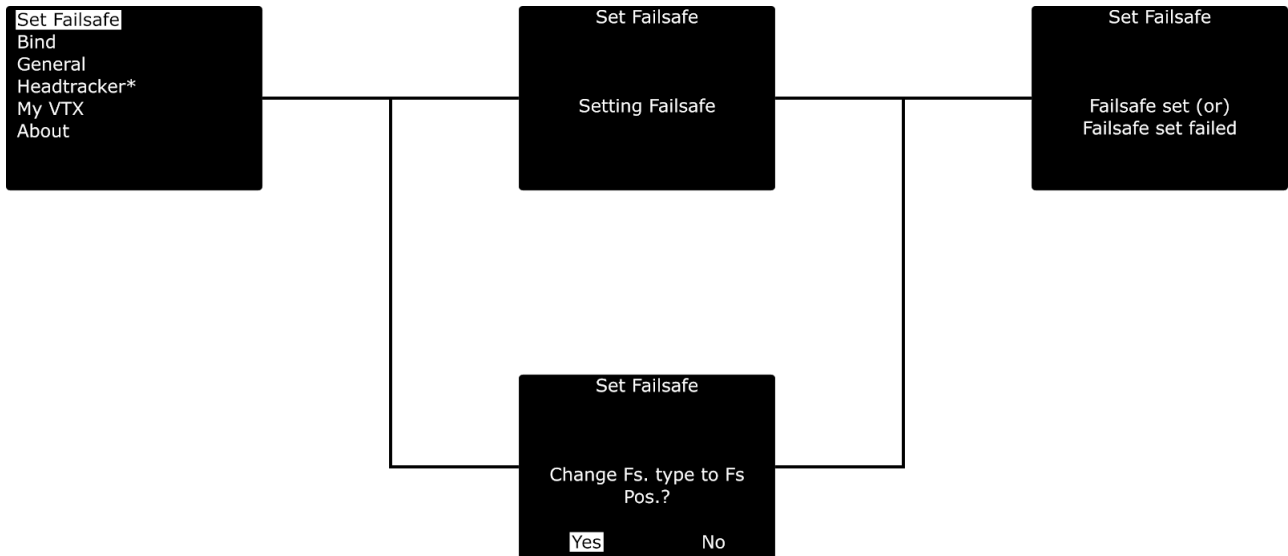

### Standard/ Lite Tx shortcut

For these two transmitters you can run a shortcut to set the failsafe position:

- Set the sticks and switches in the position you want them
- Push the joystick down
- Push and hold it up for a few seconds
- *Failsafe Set* will appear

### Failsafe test

When you have set up or changed the failsafe behavior, it's important to test the correct function on the ground. To test it:

1. Remove the propeller of your aircraft
2. Power up the radio and the model
3. Arm the model (with fc) or move your sticks in to certain position (no fc)
4. Shut down your radio
5. Depending on the failsafe type and model, check if the behavior is correct



## Transmission frequency

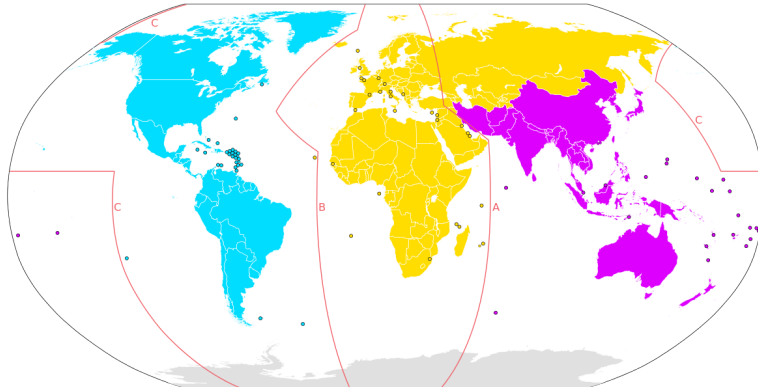

*CC Wikipedia*

The TBS CROSSFIRE supports two different frequency bands, depending on your local regulation..

Below is a general overview of the primary frequency segmentation.

General area	Frequency
ITU Region 1 - Europe/Africa/Middle East (yellow)	868 MHz SRD band
ITU Region 2 - America/Greenland (blue)	915 MHz ISM band
ITU Region 3 - Asia/Oceania (purple)	915 MHz ISM band



You can choose between several frequencies:

Frequency Setting	Frequency	Max. power level	Settings locked
868	868 MHz	No limitations	no
915	915 MHz	No limitations	no
868CE	868 MHz, LBT technique	No limitations	no
915FCC	915 MHz	No limitations	no
868 Race	868 MHz	No limitations	no
915 Race	915 MHz	No limitations	no

**868CE/ 915FCC:** same as CE/ FCC mode but with no limitations in the power level etc

**868 Race/ 915 Race:** uses double the bandwidth to avoid failsafes during bigger race events with many pilots. Only use them in these scenarios!

#### To change the frequency band:

1. Power up your transmitter
2. Open the *Crossfire Transmitter* menu
3. Navigate to the *General* menu
4. Change the *Frequency* setting according to your location

The frequency change is instant, and affects transmitter and receiver. It can even be changed in-flight if necessary. If you change the frequency or region setting without the receiver being powered up you need to rebind the receiver.

#### Region settings:

In the region settings, you can set your Crossfire according to your local laws. The region and the frequency setting will disappear after this, as well as not allowed setting for this region. The Crossfire then will limit the output power and the used band according to the law and enables LBT (CE mode only)

Region setting	Frequency	Max. power level	Settings locked
Open	Not limited	Not limited	no
CE	868 MHz, LBT technique	25mW	yes
FCC	915 MHz	1W	yes
C-Tick	915 MHz	1W	yes



## Transmission power

The transmitter's RF output power is highly configurable and can be selected dynamically via the menu. With 100mW you can achieve 15 km of safe range in rural conditions.

It is recommended to use the dynamic power option. This will allow you to fly at very low power and the system will increase the power automatically (faster than you can hit the power switch yourself) if you are about to lose the link.

Some output power restrictions apply depending on the available power source:

Power source	Available output power
USB power input (+5V)	10mW (10dBm)
RC/HT radio power input (+3.5 to +12.6V)	10mW (10dBm), 25mW (14dBm), 100mW (20dBm), 250mW 500mW (27dBm) 1W (30dBm)*, 2W (33dBm)*
External LiPo power input (+3.5V to +12.6V)	10mW (10dBm), 25mW (14dBm), 100mW (20dBm), 500mW (27dBm), 1W (30dBm), 2W (33dBm)

*\* 250mW is the maximum output power of the Micro Tx V1 . It is also only available on the micro modul.*

*Micro Tx v2 can go up to 1W*

*\*\*Please check if your Radio is capable of providing enough power for the 1/ 2 W option. Otherwise you might break the electronics inside of your radio. The TBS TANGO can handle these power levels, the Tango II can only be used up to 500mW (Standard tx) or 1w (Micro Tx v2/ Nano Tx).*

### To change RF power:

1. Enter the configuration menu/ LUA script select "General"/ "Crossfire TX" and "Max Power"
2. Pick the RF output power you require and exit the menu to confirm
3. The change is instant if the required input power is available and can be done at any moment

Every 6 dBm increase in output power results in a doubling of the theoretical possible distance that is achievable.

If you set a power level that is outside the connected power source, it will still be remembered for later but the output power will be limited to according to the table above.

You may hear a subtle buzzing or humming sound on some radios or nearby speakers on higher power levels. This is completely normal and non-harmful. In the case of the Taranis it is an issue of the remote itself and can be fixed by following [this guide by boltrc.com](https://www.boltrc.com).



## Dynamic transmission power

The system can automatically choose the power level most suitable for the situation at hand. For instance, if you fly close to the transmitter you normally only require minimal TX power and the system will therefore switch to the lowest possible TX power level required to maintain a good up-link.

The maximum TX power level the system is allowed to use, can be defined by changing “Max Power” in the configuration menu.

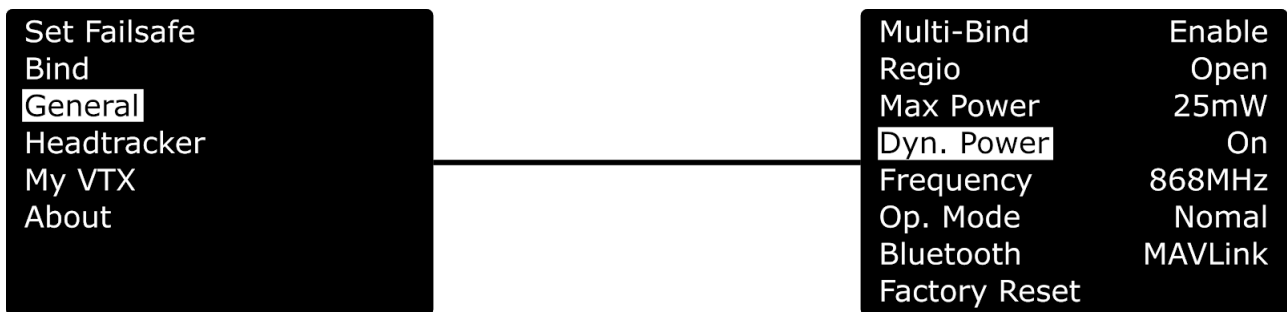

## Operating modes

Operation mode is where you can set the crossfire in an ultra-low update rate, high range mode. Normally the Crossfire switches from 150Hz to 50Hz, depending on the link quality. With *Forced Telemetry* enabled, it will now only switch between 50Hz and 4Hz mode. Only enable it if you know what you are doing.

*Note: Forced Telemetry is not meant to be used in normal conditions. The best practise is to not use it.*

## Transmitter LED status indicator









The RGB LED on the transmitter gives you at any moment an indication of your link status.

Transmitter LED sequence	Description
Pulsing	Ready, trying to connect to receiver or no down-link established
Green	Solid link, 150Hz or 50Hz link mode active
Blue	OTA Update of the receiver is running
Slow blue blinking	Update confirmation required
Fast green flashing	Transmitter bootloader active
Fast red flashing	Warning, a message is shown on the OLED display/ LUA Script
Purple	Find-mode engaged (Standard/ Lite Tx only)
Turquoise	Race mode active (150Hz locked, 25mw)
Blue	Race mode active (150Hz locked, 100mw), if no update is running!



## Receiver LED status indicator

There are three (Standard Diversity RX) or two (any other receiver) LEDs on the receiver giving you an indication of link- and backup-battery status.

Receiver LED indicators	Description
Solid green 	Link is up and running OK
Solid red 	No packages received from the transmitter and receiver is in failsafe mode
Fast red blinking 	Receiver needs a update, confirmation on the tx is required
Slow green blinking 	Receiver is in binding mode
Fast green blinking 	Receiver bootloader active or firmware upgrade running
Green is flashing 	Diversity RX is in Find-mode (up to 1 min. delay between flashing)
Double green blinking  	Authentication error. Rebind your receiver - <a href="#">more details</a>

*Find mode is only available with the diversity receivers.*

## MyVTX

With the new MyVTX menu you can set all your VTX's to the same channel, band and output power without accessing all of them. This is useful if you are on a race with multiple drones and have to set them all to the same channel.

If you enable MyVtx, all other vtx settings will be overridden temporarily, till you disable it again.

Connect your vtx to the Crossfire Rx by CRSF or Smart Audio, activate MyVtx and set the it up\*

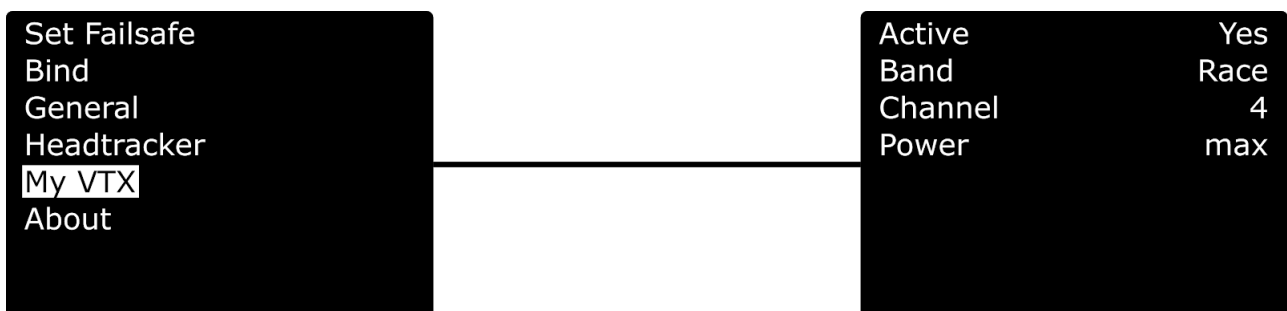

Settings	Description
Active	activate/ deactivate the global vtx settings
Band	Band settings, Race/ Low/ A/ B/ E/ Airwave/ User Frequency
Channel/ Frequency	1 - 8/ 5620 - 5920
Power	Vtx power level, 25/ 100/ 400/ max mW

\*the available pins for the connection can be found in the [output map section](#) for the receiver

## RC over MAVLink

If you use MAVLink to connect to your FC, you can send your RC data over the same connection.

Depending on the MAVLink version used in your fc, you can send up to 12 channels by this (MAV V2) or 8 (MAV V1, used on Crossfire FW below 3.8).

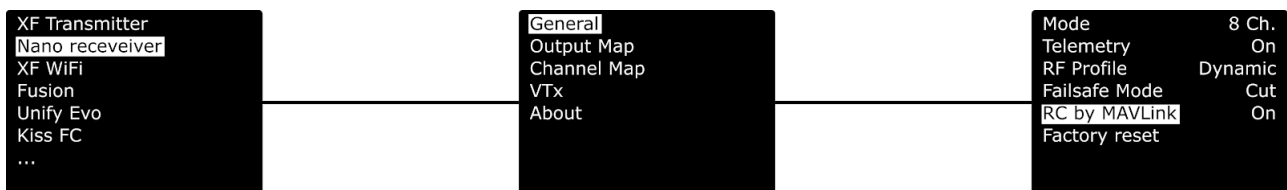

As there are some rumors around:

- The rc data will not stop being send, if the crossfire telemetry breaks up
- It's as fast/ a bit faster than SBus



## Special functions - Standard/ Lite TX only

### External power

Your Standard/ Lite Tx can go up to 2W transmission power. If your Radio can not handle the current for this or you don't want to drain your radio battery as fast you need to attach an external battery to the XT30 connector. You can use any 2(1) - 3S LiPo for this. To make sure the Crossfire uses the external battery, the voltage needs to be higher than the voltage in the JR bay. Mostly the supply voltage in the bay is the same as your radio battery.

The Crossfire uses the source with the higher voltage.

### Status display

After power-on, the main screen shows the current state of the transmitter, i.e. link status, transmission power, R/C- and head-tracking input signal state.

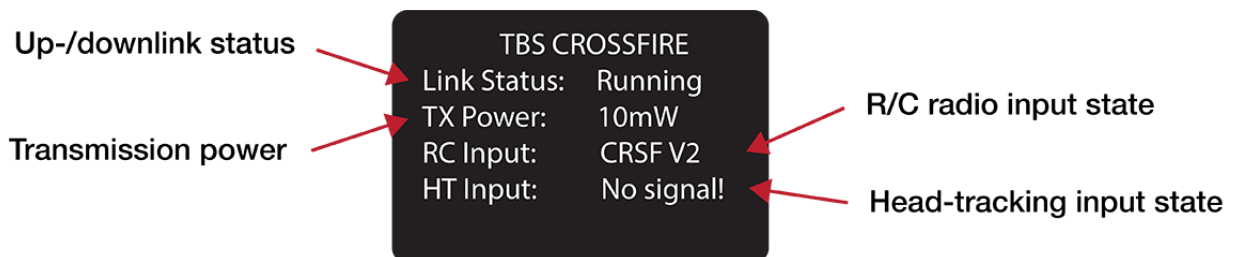

- **Link Status** - State of the wireless link [Connecting, Running]
- **TX Power** - Output transmission power [10mW, 25mW, 100mW, 500mW, 1W, 2W]
- **RC Input** - Radio R/C PPM signal input status [No signal, PPM, CRSF V1/V2]
- **HT Input** - Head-tracking PPM signal input status[No signal, Signal OK]

### Up- and downlink status

Toggle the joystick to the right to show the status of the up- and downlink.

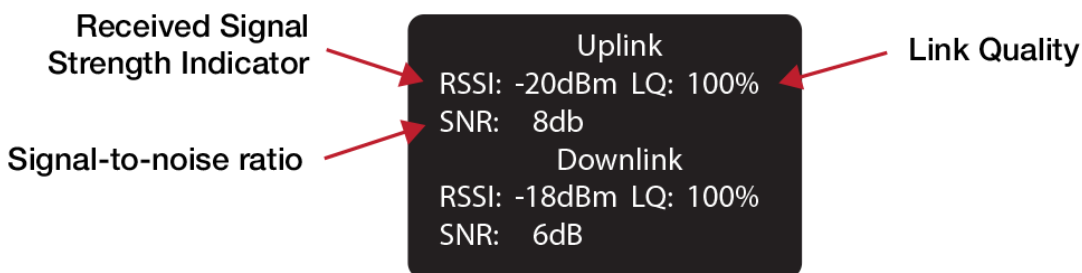

- **RSSI** - Received signal strength indicator, measurement of the power present in a received radio signal [typ. -1dBm (good) to -130dBm (bad), logarithmic scale]
- **LQ** - Link Quality, based on the percentage of signal data received at the end-point [0 to 300%]





- **SNR** - Signal-to-noise ratio, compares the level of a desired signal to the level of background noise

## Oled Menu

When you scroll to the left/ right, you can see the other diagnostic screens, showing you informations of you link etc:

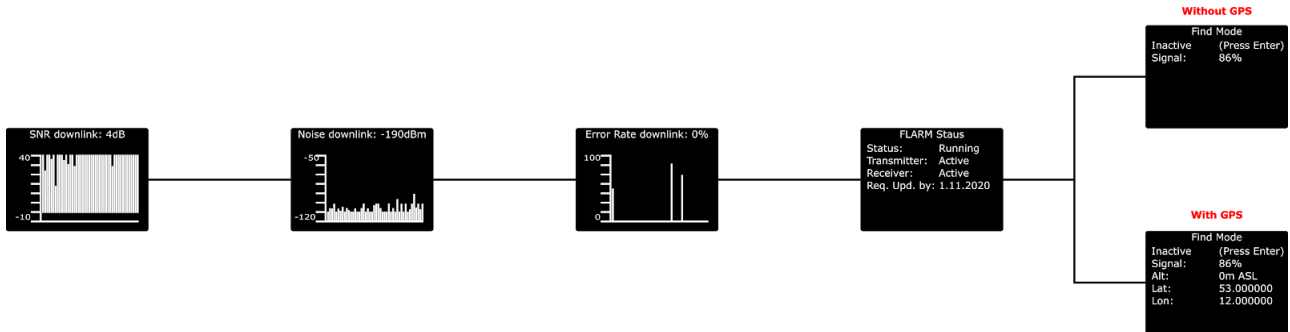

## Find Mode

The Find-mode provides you with a way to locate a downed aircraft. A GPS signal is currently required to use this mode. Install our TBS GPS module by BST or any other GPS, connected to a flight controller.

In normal use the GPS coordinates are continuously updated and the latest data is displayed on the "Find Mode" screen. If the model loses power you can review the last known coordinates to locate your model.

### Without GPS

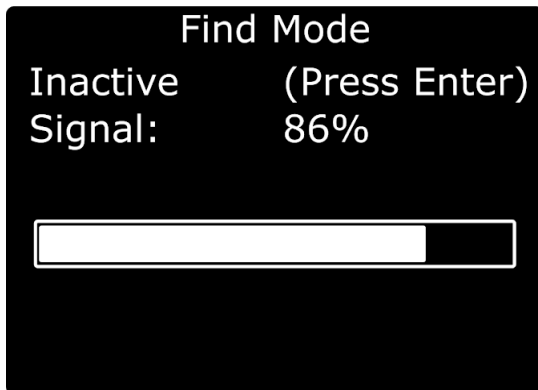

### With GPS

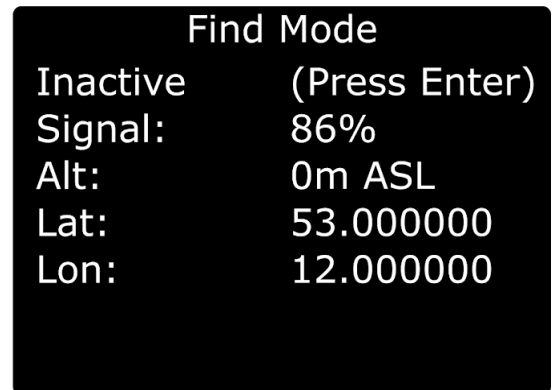

- **Inactive (Press Enter) / Active** - Enable/disable the Find-mode, shows on-board LiPo voltage  
Do NOT enable during flight!
- **Signal** - Receiver signal strength, makes it possible to triangulate the location [0 to 100%]
- **Alt** - Altitude above Sea Level, GPS required
- **Lat** - Latitude, GPS required
- **Lon** - Longitude, GPS required

The standard div. receiver has an on-board LiPo battery to operate in beacon-mode, on the nano div. receiver you got



---

solder pads for a 1s lipo with bms. This allows the transmitter to send the last known GPS coordinates to the display on the transmitter, after certain trigger events have happened. See the operation flow diagram attached on the following page.

### **Direction finder**

Using the transmitter antenna together with a DIY parabolic reflector, you can estimate the heading of the receiver by looking at the signal strength indicator. Use this option only if the GPS position is inaccurate or you don't have a GPS connected.

### **How does find mode work**

Please see the flowchart to see when the receiver decides to shut down or enter find mode. In short the receiver shuts down if transmitter and receiver are close to each other or the receiver never got a signal from the TX, In any other case it enters the find mode if there is a power down event. If the main battery is still powering the system after a crash the receiver will not enter the find mode and keeps running in the selected operation mode.

Once the receiver enters the find mode also a power saving mode will be activated. This power saving mode will decrease the beacon signal interval over time. It stays for 10 beacon signals on the same interval level and remains on the slowest once reached. The interval levels are 1s, 5s, 10s, 15s, 30s and 60s. This means it can take up to 60s for your transmitter to pick up a beacon signal. This is required to make the receiver run as long as possible. Once the transmitter receives a beacon signal and sends an acknowledgement the receiver will switch back to the fastest interval until the link is lost again.

Once a connection is established the receiver will share the GPS information with the transmitter if a GPS source is connected or RSSI values to find the receiver with signal strength and the DIY reflector.

### **Testing find mode**

It is highly recommended to go through a crash scenario first so that you are fully aware of all the neat things we have packed into the Find Mode or Beacon Mode of the TBS Crossfire system.



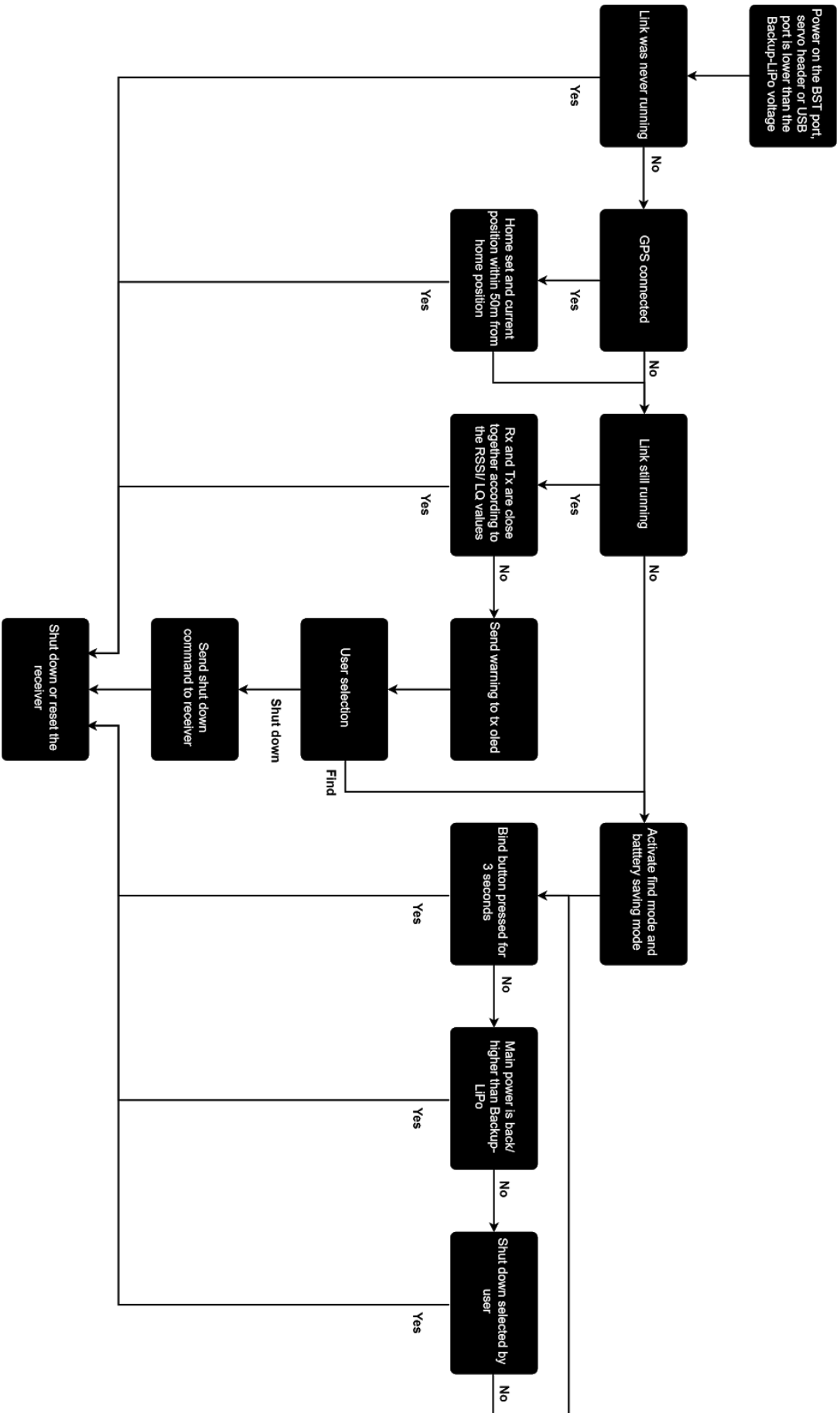

---

## Preparations

The find mode needs to be armed before it will take any action.

- Receiver only:
  - Power up receiver and transmitter and make sure they are connected to each other.
- Receiver with GPS:
  - Make all steps above and ensure the GPS is having a solid sat lock.
- Receiver with GPS and TBS CORE PRO:
  - Make all steps above and simulate a take off. This can be done throttle above 3A or walking your receiver until you see the take off message on the OSD.

## Simulating flight

The find mode is armed now and you need to simulate a flight. Just separate the transmitter and receiver by more than 50 meters.

## Simulating a Crash

A crash can happen in different ways. Let's simulate it only :) Here are some scenarios.

- Turn off your transmitter ( failsafe ) and move your plane to another spot (scenario: flying behind a mountain, with subsequent crash )
- Power down the battery (scenario: battery eject on crash)
- Just let it sit there (scenario: landing in a tree)

## Search and rescue

The copter/plane is lost - now we'll start the S&R mission. It's important to get the link back to either get the latest GPS coordinates or have the ability to point into the direction based on the signal strength.

- In some cases the link is not even lost. Skip below and move to "Link regained" chapter
- Read the coordinates from your OLED and go to the place of the latest coordinates. If you don't have a GPS try to go as close as possible to the last known position.
- Get yourself to an exposed position as close to the target as you remember from the crash or based on OLED coordinates
- Toggle between find mode (greater range, less telemetry) and full link (less range, full telemetry). If you have lost main power your quad will respond in find mode. For all other scenarios, you should be able to regain control. When you see "find mode activated" on your LCD, give it more than a minute before you deactivate it again ( beacon timing, see description above ). If you use the DIY reflector point and hold in different directions until you get your link back.



---

## Link regained

Once you got your link back to your copter/plane you can now try to find it. It's recommended to keep the mode you got your signal back no matter if it's actually find mode or selected operation mode.

- GPS source attached to receiver
  - The receiver will share the latest coordinates with the transmitter and display them on the OLED.
  - For Droidplanner app select Bluetooth ( Crossfire App link mode needs to be set to MAVLink emulator ) to locate your copter/plane
  - Write down the coordinates use any GPS to find the location
- No GPS source attached
  - Make your transmitter antenna a directional one. This can be done by the DIY reflector or you can use your body to lower the signal strength from one direction ( works for emergencies )
  - Turn yourself slowly in a circle and try to figure out the direction the signal strength is the strongest. Walk this direction and repeat this until you find the copter/plane. For this practice some exercise is recommended.

## Disable find mode on the receiver

If the receiver is in Find-mode it can be cancelled by pressing the "Bind"-button 3x. So if you are back home and the receiver still thinks it got lost, you can turn it off by this. Or check the OLED screen to deactivate the Find-mode from the transmitter (Standard/ Lite TX).

The (on-board) LiPo battery in the diversity receiver is automatically charged every time the receiver is used. On the Standard diversity Rx you got a third LED indicator on the front face displays the current state of the battery.

LiPo LED indicator	Status
Red ■■■	Backup battery is charging



---

## Real time telemetry by Bluetooth

The Standard Tx (not the Lite version) got a built-in bluetooth module that you can use for real time telemetry or wireless configuration of your fc. Depending on the incoming data, the Crossfire selects the Mode for the bluetooth module for you.

For this you got different operation modes you can set it up to:

- **OFF**
  - Bluetooth module is completely disabled and won't show up if you search for devices
- **MAVLink Emulator (MAV Emu)**
  - This mode is recommended if you have any kind of GPS source attached over BST ( TBS GPS, DJI NAZA over TBS BLACKBOX, ET Vector, BetaFlight etc). If this mode is selected an FC is emulated inside the TBS CROSSFIRE transmitter. This gives you the ability to track your copter/plane in real-time with any MAVLink capable app on your phone (e.g. [Droidplanner app](#)) or GCS on your PC or MAC (e.g. [QGroundControl](#))
- **Serial Bridge**
  - This mode is used for serial bridge between your connected device and the receiver
  - It can be used to wirelessly configure your fc
  - If serial datas are registered from the receiver, the module will switch to this mode
  - As soon as the Crossfire switches to 50Hz mode, the transmission will be stopped
- **MAVLink**
  - This mode is used to pass MAVLink messages back and forth. Use this mode if you have a MAVLink FC connected to the receiver.
  - If Mavlink packages are detected by the Crossfire receiver, the module will switch to this mode
  - You can use the same applications as for MAVEmulation
  - With a MAVLink fc you can wirelessly configure your fc (more details can be found in the [Mavlink over Bluetooth](#) section)

## Head-tracking

The standard TBS CROSSFIRE transmitter supports standard head-tracking input via the right 3-pin HT port. Solder the included pigtail cable to suit your particular head-tracking setup. Only a two wire connection between TBS CROSSFIRE and the head-tracker is required. The PPM feed from the head-tracker needs to be connected to the PPM pin of the PPM pin and ground needs to be connected to ground of the 3-pin PPM cable.

The status display will indicate if the signal has been recognized properly. Inside the menu under *Headtracker*, three functions for pan, tilt, and roll are freely mappable. Each function has a source and



---

destination selection. The selected channel under source will replace the channel selected under destination. This gives you the ability to map your headtracker channels from any channel of the *Headtracker* input to the RC link frame.

XX Source: the channel number where the signal for this axis is incoming. On FatShark

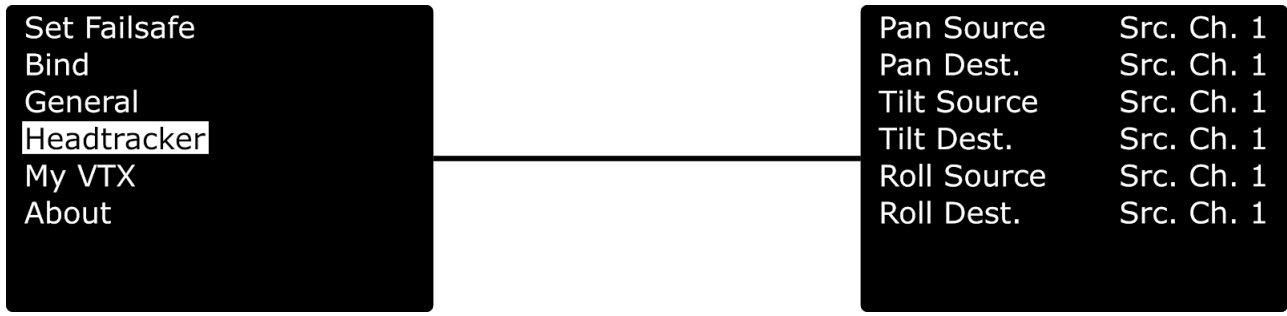

# Receiver functions

## Output map

On all receivers you can select what it should output on which pin. The available options for each differ for the receivers:

Receiver pin	Output type Diversity RX (standard)	Default value
1	PWM Ch1 bis 12, PPM, RSSI, LQ, RSSI/LQ	PWM Ch. 1
2	PWM Ch1 bis 12, PPM, RSSI, LQ, RSSI/LQ	PWM Ch. 2
3	PWM Ch1 to 12, RSSI, LQ, RSSI/LQ, SBUS, n.i.SBUS, Serial TX, MAVLink TX, CRSF TX, SmartAudio	PWM Ch. 3
4	PWM Ch1 bis 12, RSSI, LQ, RSSI/LQ, Serial RX, MAVLink RX, CRSF RX	PWM Ch. 4
5	PWM Ch1 bis 12, RSSI, LQ, RSSI/LQ	PWM Ch. 5
6	PWM Ch1 bis 12, RSSI, LQ, RSSI/LQ, Serial RTS	PWM Ch. 6
7	PWM Ch1 bis 12, RSSI, LQ, RSSI/LQ, Serial RX, MAVLink RX, CRSF RX	PWM Ch. 7
8	PWM Ch1 to 12, RSSI, LQ, RSSI/LQ, SBUS, n.i.SBUS, Serial TX, MAVLink TX, CRSF TX, DSMX, SmartAudio	PWM Ch. 8

Receiver pin	Output type Diversity RX (Nano)	Default value
1	PWM Ch1 bis 12, PPM, RSSI, LQ, RSSI/LQ, CRSF TX	PWM Ch. 1
2	PWM Ch1 bis 12, PPM, RSSI, LQ, RSSI/LQ, CRSF RX	PWM Ch. 2
3	PWM Ch1 to 12, RSSI, LQ, RSSI/LQ, SBUS, n.i.SBUS, Serial TX, MAVLink TX, CRSF TX, DSMX, SmartAudio	PWM Ch. 3
4	PWM Ch1 bis 12, RSSI, LQ, RSSI/LQ, Serial RX, MAVLink RX, CRSF RX	PWM Ch. 4
5	PWM Ch1 bis 12, RSSI, LQ, RSSI/LQ, Serial RTS	PWM Ch. 5
6	PWM Ch1 bis 12, RSSI, LQ, RSSI/LQ, Serial RTS	PWM Ch. 6
7	PWM Ch1 bis 12, RSSI, LQ, RSSI/LQ, Serial RX, MAVLink RX, CRSF RX	PWM Ch. 7
8	PWM Ch1 to 12, RSSI, LQ, RSSI/LQ, SBUS, n.i.SBUS, Serial TX, MAVLink TX, CRSF TX, DSMX, SmartAudio	PWM Ch. 8





Receiver pin	Output type Micro V2/ Nano rx	Default value
1	PWM Ch1 to 12, PPM, RSSI, LQ, RSSI/LQ, SBUS, n.i. SBUS, CRSF TX, MAVLink TX, SmartAudio, DSMX	CRSF TX
2	PWM Ch1 to 12, PPM, RSSI, LQ, RSSI/LQ, CRSF RX, MAVLink RX	CRSF RX
3	PWM Ch1 to 12, PPM, RSSI, LQ, RSSI/LQ, CRSF RX, MAVLink RX	PWM Ch. 3
4	PWM Ch1 to 12, PPM, RSSI, LQ, RSSI/LQ, SBUS, n.i. SBUS, CRSF TX, MAVLink TX, SmartAudio, DSMX	Smart Audio
5 (BST)	PWM Ch1 to 12, RSSI, LQ, RSSI/LQ, BST SDA	BST SDA
6 (BST)	PWM Ch1 to 12, RSSI, LQ, RSSI/LQ, BST SCL	BST SCL

## CRSF

CRSF is a protocol designed by Team BlackSheep and championed through the TBS Crossfire remote control system. It has been integrated into most popular remote controls, is an incredibly high bandwidth (low latency) full duplex, serial data transmission protocol. It comes with native functionality such as OTA (over the air) firmware upgrades, localized configuration menus and a smart routing protocol.

CRSF can be selected on multiple outputs at the same time to connect several devices at once

## Serial

The bridge feature gives you the ability to pass any kind of serial uart data from any device connected to the receiver to any device connected to the transmitter. If you selected "Bridge TX" on a capable pin the following pin will be set to "Bridge Rx" and the following to "Bridge RTS" (if not used by any other Serial protocol). Please connect your device according to this information. The baud rate is set to 57600 8N1 and the voltage level is 3.3V only. The RTS pin will change to logical high when the internal FIFO is almost full and low if the FIFO is almost empty. There is no hardware flow control for the uplink as the wireless close range telemetry module does not support it.

## SBUS

SBus is the signal that is used by FrSky and other brands. The signal is inverted, which means on a F4 FC you need to use a pad with a built-in signal inverter. Those pads are mostly label with "SBus" on your FC

## N.i. SBUS

Not inverted SBUS is the same as SBUS except that the signal is not inverted. This can be used for FCs that have no signal inverter built in and require SBus as input signal.



---

## MAVLink

MAVLink is a very lightweight, header-only message marshalling library for air vehicles. Most of the common flight controllers support MAVLink message format. For specific message documentation please refer here: [MAVLink Messages](#)

If you select "MAVLink TX" on one of the available outputs the corresponding output will be set to "MAVLink RX". There is no hardware flow control required as we support software flow control (RADIO\_STATUS message) on both ends. You can connect it to any telemetry port of a MAVLink compatible FC. The MAVLink baud rate is set to 57600 baud. The MAVLink TX pin needs to be connected to the FC telemetry RX pin and the MAVLink RX pin needs to be connected to the FC telemetry TX pin. The Crossfire supports MAVLink V1 and V2, which will be selected automatically by the incoming messages.

You use the MAVLink connection to send your RC data as well. If you FC supports MAVLink V2, this includes up to 12 channels, with V1 up to 8 channels.

## PWM (Ch X)

If you select CH 1-12, the Crossfire will output a standard 50Hz PWM signal, that can be used for all servos and FC's without digital rc input.

## PPM

Sends up to 12 channels by PPM. Only use it on old-style flight controllers with no serial rc input.

## DSMX

DSMX is designed to use the Crossfire as a backup system for Spektrum receivers.

## RSSI

Translates the RSSI from 0 - -130dBm to PWM signal from 2000µs to 1000µs. This can be used for old-style osd's with only analog rssi input

## LQ

Translates the Link Quality from 0 -100% to a PWM signal from 1000µs to 2000µs. This can be used for old-style osd's with only analog rssi input.

In 150Hz mode the LQ indicator will remain at 100% as it's not relevant to monitor it in the mode.

## RSSI/LQ

Combines the LQ and RSSI and translates them from 0 -100% to a PWM signal from 1000µs to 2000µs. The RSSI/LQ value will always show the worse value of both

## Smart Audio

SmartAudio is a protocol developed by TBS for OSD to VTx communication. SmartAudio is a single-wire



---

UART protocol, running over the (Audio)-wire. All versions of Smart Audio are supported.

## Channel map

The channel map menu is almost like the output map, except that you can change the channel order which also affects the channel order for any serial protocol. If you own a radio without flexible channel mapping, you can do it here.

This is also used to inject the LQ sensor for your FC. An example can be found in [this section](#).

The possible settings:

- **Channel 1-12:** Any channel coming from the remote
- **LQ:** same as the output map setting
- **RSSI:** same as the output map setting
- **RSSI/LQ:** same as the output map setting

Example:

```
Dst. Ch. 1    CH1
Dst. Ch. 2    CH2
Dst. Ch. 3    CH3
Dst. Ch. 4    CH4
Dst. Ch. 5    CH5
Dst. Ch. 6    CH6
Dst. Ch. 7    CH7
Dst. Ch. 8    LQ
```

## Channel number

The transmitted number of channels. Can be set to **8** or **12** channels.

Use the 8 channels setting whenever you can. This ensures the best performance for your rc link.

## RF Profile

Lock the Crossfire to a fixed frequency or let it select it by the quality of the link.

- **Dynamic:** The Crossfire selects the RF profile due the internal algorithm based on the quality of the link. It will switch between 150Hz on ideal conditions and 50Hz when the link is no longer perfect. This happens many times per second. This is the best setting for most cases. When you disable the telemetry or the telemetry breaks up, the crossfire will switch to 50Hz mode.
- **50Hz:** Locks the Crossfire to 50Hz mode. Use this setting if you encounter issues with your link
- **150Hz:** Locks the Crossfire in 150Hz mode. This is useful if you are on a race and want the low-latency during the whole flight. In this mode the range is limited so only use it on a race or a



---

race-like situation.

## Telemetry

**Enables** or **disables** the telemetry for the receiver.

When you should disable the telemetry:

- On a race. This frees the band for other pilotes.
- When you got black lines in your video feed. Make sure your cables are shielded or twisted to avoid this issue in general

If you disable it, dynamic rf, dynamic power and the telemetry will no longer work. This means you Crossfire Tx will send with the maximum set up power level and switch to 50Hz mode.

The LUA scripts are not affected by this. The Crossfire re-enables the telemetry for the time the datas are sent and then turns it back off.



## Available sensors with OpenTX

With a OpenTX based radio you can receive the following sensors, depending on your connected hardware:

Datapoint	Description	Data source
1RSS	Uplink - received signal strength antenna 1 (RSSI)	TBS CROSSFIRE RX
2RSS	Uplink - received signal strength antenna 2 (RSSI)	TBS CROSSFIRE RX
RQly	Uplink - link quality (valid packets)	TBS CROSSFIRE RX
RSNR	Uplink - signal-to-noise ratio	TBS CROSSFIRE RX
RFMD	Uplink - update rate, 0 = 4Hz, 1 = 50Hz, 2 = 150Hz	TBS CROSSFIRE RX
TPWR	Uplink - transmitting power	TBS CROSSFIRE TX
TRSS	Downlink - signal strength antenna	TBS CROSSFIRE TX
TQly	Downlink - link quality (valid packets)	TBS CROSSFIRE TX
TSNR	Downlink - signal-to-noise ratio	TBS CROSSFIRE TX
ANT	Sensor for debugging only	TBS CROSSFIRE TX
GPS	GPS Coordinates	TBS GPS / FC
Alt	GPS Altitudes	TBS GPS / FC
Sats	GPS Satellites acquired	TBS GPS / FC
Hdg	Magnetic orientation	TBS GPS / FC
RxBt	Battery voltage	TBS GPS / FC/ Crossfire Rx/ Core
Curr	Current draw	TBS GPS / FC/ Crossfire Rx/ Core
Capa	Current consumption	TBS GPS / FC/ Crossfire Rx/ Core
Ptch	FC Pitch angle	TBS GPS / FC
Roll	FC Roll angle	TBS GPS / FC
Yaw	FC Yaw angle	TBS GPS / FC
FM	Flight mode	TBS GPS / FC

\* Source: FC means all FC's with MAVLink or CRSF connection. Core means Core Pro, FPVision, Unify Evo

## Missing sensors

If you got issues finding sensors or only a few appear, make sure you disabled *Ignore Instances* in the telemetry settings page of your radio





### In-built Voltage monitoring

The Crossfire receivers are capable of measuring the voltage of their power supply . This becomes handy when you use a rc glider where space matters.

This feature works on up to a 2s LiPo (max. Operation voltage for all receivers!) for almost all receivers, except for the Nano Rx rev 43 and lower.

If you experience issues with a other voltage sensor in your system, you can disable the Crossfire sensor in the settings under *Receiver/General - Voltage Sensor*

### Bst connection

BST (Blacksheep telemetry) is a bus system used by TBS to connect your gear like the TBS GPS puck, CORE PRO etc.. All devices are connected in parallel. The BST bus needs to get clean 5v to power up the connected devices:

Power type:	BST 5V	VBATT	BEC 5V	FC 5V
<b>TBS CROSSFIRE</b>	✓ PWR IN		✓ PWR IN	
<b>TBS BLACKBOX (discontinued)</b>	✓ PWR IN			✓ PWR IN
<b>TBS GPS</b>	✓ PWR IN			
<b>TBS CORE PRO / FPVISION</b>	✓ PWR OUT	✓ PWR IN		
<b>TBS CURRENT SENSOR</b>	✓ PWR IN	✓ PWR OUT		



---

If you own a Nano Rx, there is no longer the complete BST plug available on it. In this case, just connect SCL to SCL and SDA to SDA on all devices. The Pinout of the plug in general:

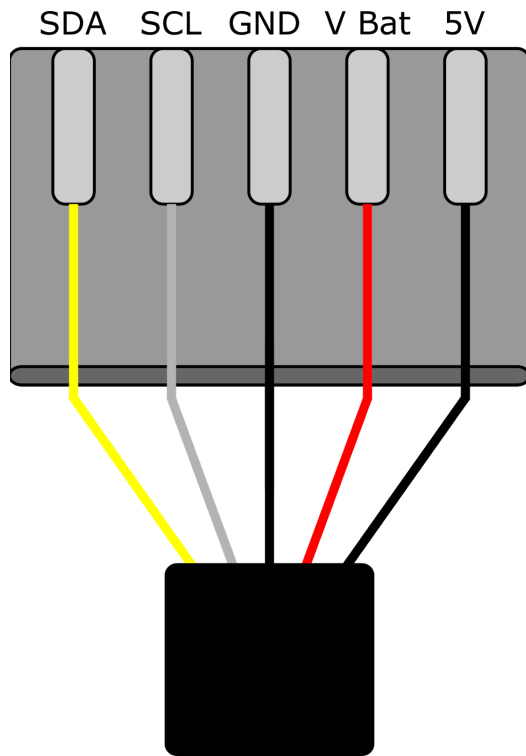

*Note: even if the BST bus got the same labels as your non-TBS GPS or compass, they don't work on the BST bus!*



---

## Additional informations

### TBS CLOUD

All the TBS Crossfire transmitters\* and the Fusion video receiver includes a built-in WiFi module which allows you a connection with all your gear through the TBS Cloud. This allows for features like VTx follow\*\*, dynamic VTx power\*\* and other upcoming features.

*Note: at the moment all the Cloud features require a hotspot with internet access.*

*\*if you own a Standard Tx from 2015/2016, the WiFi module in the JR adapter is missing. You can replace the adapter with a new one [from TBS](#).*

*\*\*[TBS Fusion](#) video receiver required*

### Menu

- **WiFi Client**
  - **AP Mode:** enables/ disabled the WiFi module
  - **Default SSID:** enables/ disables the SSID broadcast
  - **SSID:** SSID/ name of the connected/ selected network
  - **Password:** enter the password for the network
  - **Connect:** manually connect to the network. Only necessary when a new network is chosen under *SSID*
  - **Scan:** scans for WiFi networks. Found networks can be chosen under *SSID*, manual reconnect by *Connect* is required
  - **Forget WiFi:** erases all saved networks and there password
  - **Upgrade:** starts the self update for the WiFi firmware. **Disabled at the moment**
- **UDP**
  - **MAVLink:** enables/ disables the sending of MAVlink data over the wifi
  - **Port:** change the UDP port where the telemetry will be send
- **WebUI**
  - **Login:** enables/ disables the login with or without a password
  - **Password:** set up a password for the WebUI login
- **About**
  - **WiFi:** name of the network your Crossfire is connected to
  - **IP:** IP address the module got
  - **Server:** connection status
  - **Firmware:** version number of the WiFi firmware
  - **Hardware:** hardware revision of the WiFi module
  - **Bootloader:** version number of the Bootloader firmware





- **Serial Number:** serial number of the WiFi module

## Initiate the WiFi module

To use the Cloud functions, you need to initiate the WiFi module first:

- Download and unpack the firmware files for the WiFi module from [TBS](#)
- Connect the Crossfire Tx to your radio and power it up
- Search for a new WiFi network like "TBS\_XF\_AP\_XXXXXX"
- Connect your pc with this network. On Windows machines this can take up to one minute
- Open your browser and enter ip in the address bar: 192.168.4.1
- Click on *Select file* and search for the unpacked firmware files you downloaded before



- Hit *Update* and wait for the website to reload
  - **Do not shut down your radio during this**
- Now you can see the WiFi module in your Crossfire menu/ LUA script and Agent X

[Here](#) you can find the whole process as video

## Connection to a WiFi hotspot

Once your WiFi module is initiated, you now can connect to your hotspot. The easiest way is to connect it by the **Web-ui**:

- Connect the Crossfire Tx to your radio and power it up
- Search for a new WiFi network like "TBS\_XF\_AP\_XXXXXX"
- Connect your pc/ phone with this network. On Windows machines this can take up to one minute
- Open your browser and enter ip in the address bar: 192.168.4.1
- Open the *WiFi* tab
- Click on Scan to search for available networks
- Click on the name of the found network you want to connect to - the name will be entered for you
- Enter your password and hit Connect/ Disconnect
- When you refresh the page after a few seconds, you can see the IP address of the module
- Done



---

**LUA script or the CRSF menu work as well:**

- Connect the Crossfire Tx to your radio and power it up
- Navigate in the Crossfire menu to *WiFi/ General*
- Hit *Scan* to search for available networks
- Under *SSID* you can select the found network
- Insert the password under *Password*
- Click on *Connect* to start the manual connection
- Done



## OTA update of the WiFi Module

When your WiFi module is on FW 1.25 (not yet available), you can use the self-update feature:

- Connect your WiFi module to a hotspot with internet access
- Open the Crossfire WiFi device by Agent X, Lua script or CRSF menu
- Under *General* you find *Update*
- Hit Update and follow the instructions on the screen
- When the message disappears, the module is successfully updated

At the moment the self-update check will result in your *module is up to date* message no matter which version you use!

## Opentx setup for crossfire

If you own a OpenTX radio, you need to set up your model like this:

**Internal RF: off** and **External RF: CRSF**



Note: those settings need to be done on all models where you use your Crossfire.

Using CRSF will give you the lowest possible latency from your stick to the drone and full telemetry back to your radio.

## LQ warning in OpenTX

The setup for the radio is relay simple:

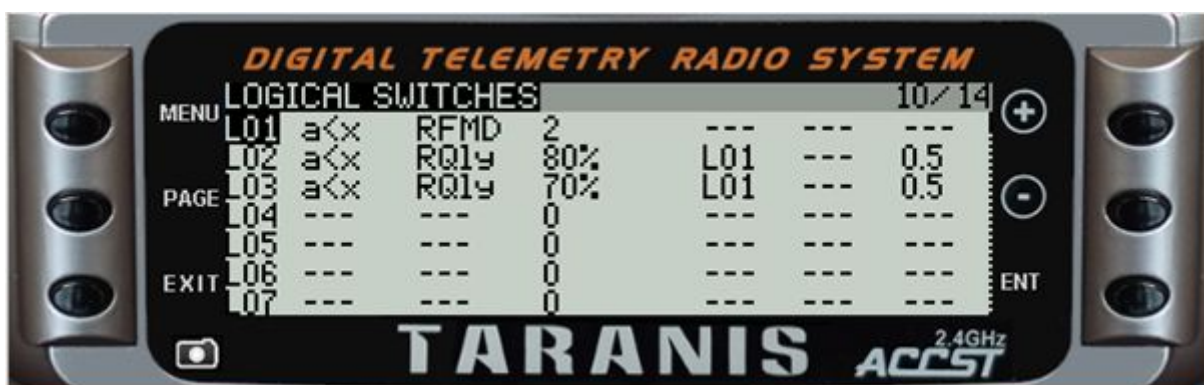

What they mean:

L01: Monitors the Crossfire frequency mode, activated when it's not in 150Hz mode

L02: Activ when the Link quality drops below 80% (pre warning) AND 50 or 4 Hz mode is active

L03: Same as L02 but with the critical warning level at 70%

L02 and L03 also got a small delay (0.5s) to avoid warnings when the signal is only bad for a short moment.

**Note: since Crossfire fw 2.93, the RFMD no longer needs to be compared as the LQ sensor will stay at 100% while in 150Hz mode (RFMD = 2)**



With the logical switches the voice alerts will be triggered every time they are active.

What they mean:

SF1: when L02 is activ, plays the selected track ones -but not at the startup

SF2: same as SF1 for the critical warning

For the sounds you can create your own with a free TTS creator on the internet.

## Model match in OpenTX (and FreedomTx on Tango 2)

Model match enables you to make sure that a specific receiver and drone with it only binds if the correct radio model is selected. In case you switched from a drone to a wing and forgot to change the model, the Rx will simply not bind (unless you start the bind procedure).

You need to make sure that you don't use an id twice in different models. In this case, the Rx will bind to both of them!



Note: Model match and [Multi Bind](#) does not work together if the model id is not the same in both radios.

Model Id radio 1		Model Id radio 2
00	✓	00
01	✗	00
03	✗	01
./.	✓	./.
00	✓	./.

**Note:**

At the moment, OpenTX does not support the model match function in their stable release. This means that you need to make sure that you selected the right model in your radio.

Due to this, you can use the same model in your radio with all your drones. Model match is available as nightly build (2020.08.21) from TBS. You can download the OpenTX version [here](#).

In OpenTX your model number in the memory will be set as default Model Id when you create a new model. If you want to use Multi Bind on a other radio with no Model Id option, make sure you have set it to 00 before



## Model Id (Model Match) in FreedomTx (Tango 2)

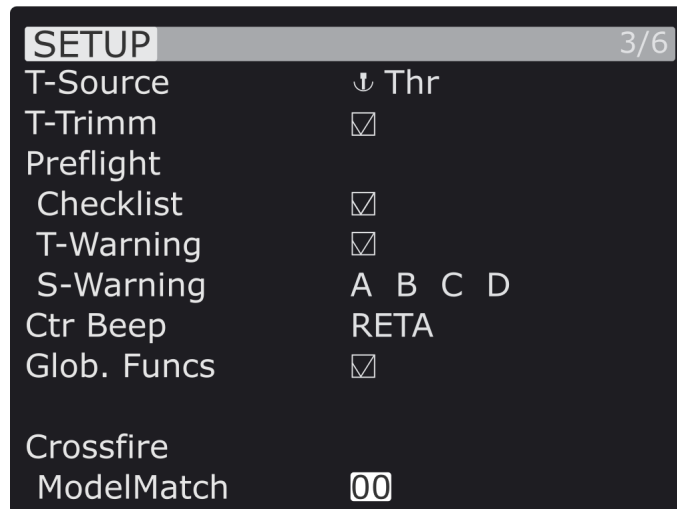

## Model Id (Receiver No.) in OpenTX

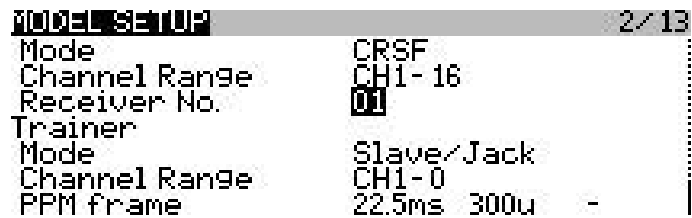

## Vtx connection by CRSF

All Unify32 and Evo line VTx's from TBS are capable of using CRSf to communicate with the Crossfire ecosystem.

- Select a free output pin capable for CRSF (check the [output map section](#) for available outputs)
- Set the Unify32 to CRSF by button or USB (Evo and Unify32 HV)
- Connect them (Crossfire Tx to VTx Rx, Crossfire Rx to Unify Tx)

Wiring example:

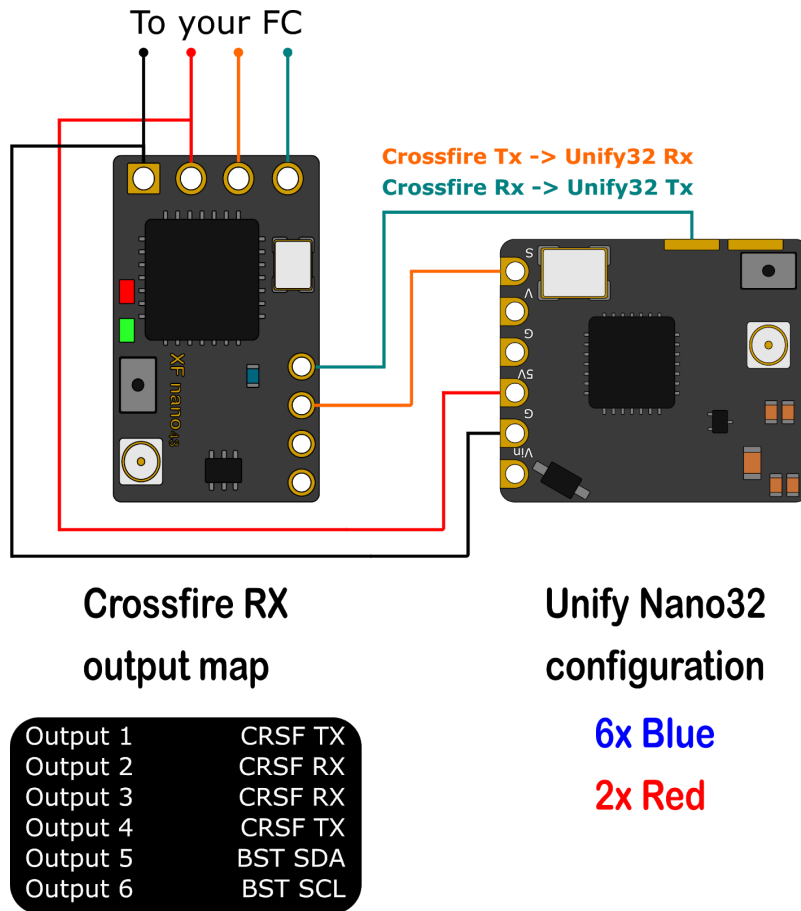

## Vtx connection by SmartAudio

If you own any Unify or any other VTx with SmartAudio capability, you can connect it to your Crossfire receiver as well.

- Select a free output pin capable for SA (check the [output map section](#) for available outputs)
- Connect them (Crossfire Tx to VTx Rx/ SmartAudio pad)

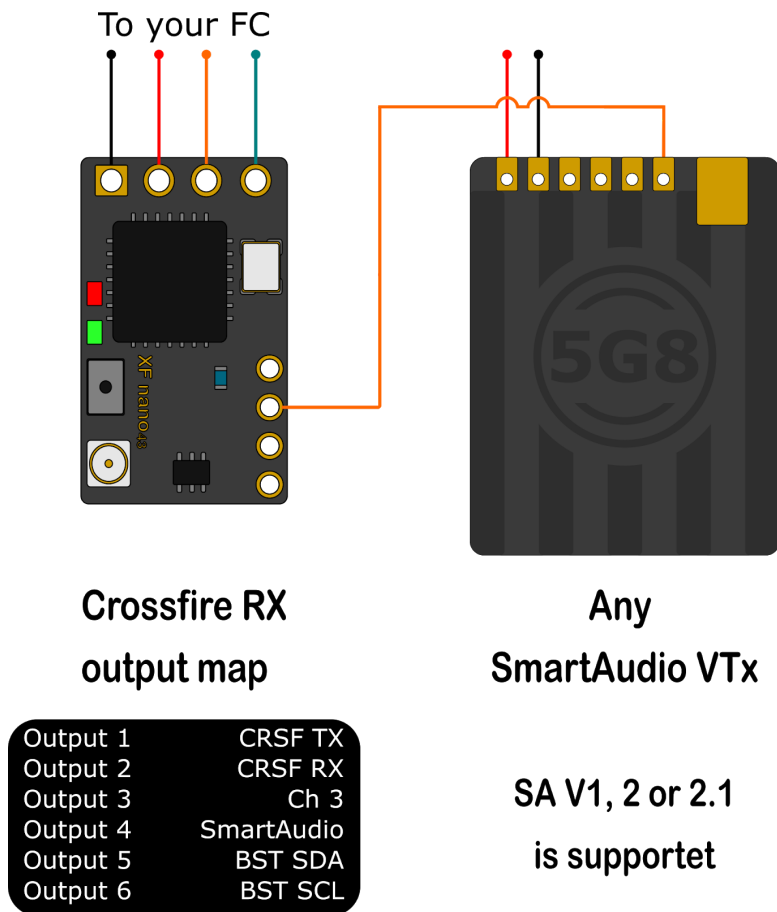

## Smart Audio or CRSF for the VTx?

Both protocols had their advantages and disadvantages:

- **SmartAudio**
  - Single wire connection. Saves one PWM output (useful if you got a wing and use the bst pins for bst)
- **CRSF**
  - OTA Updates (upcoming)
  - Full y configurable by LUA, Crossfire OLED, FUSION etc.
  - CRSF readout - let you use PITMode on a switch or navigate through the Unify Evo OSD without the need for a fc, link stats readout with the Unify EVO OSD





## VTx button is not working

When the Unify32 detects a signal on the SmartAudio Signal-in pad, it will disable the button. To change the VTx to CRSF or SA, you can unsolder the wire or force your crossfire rx to not output any signal.

- Set the output of the Crossfire Rx to CH X (PWM) for the pin where the VTx is connected to
- Shut down the Crossfire Tx and Rx
- Power up just the drone with the Crossfire Rx and the Unify32
- Change the Unify32 settings by the button
- Turn the transmitter back on
- Set the output map back to CRSF or SmartAudio

## Connection to an FC

### General wiring

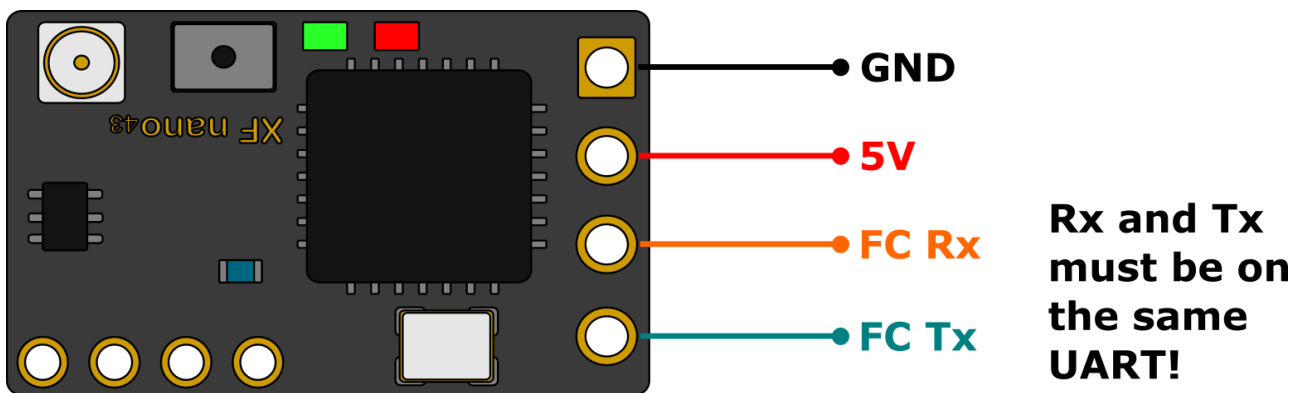

If you use SBus or any other protocol beside CRSF or MAVLink, you only need to connect the receivers Tx line to your FC. Use CRSF whenever possible to get the best experience with your Crossfire.

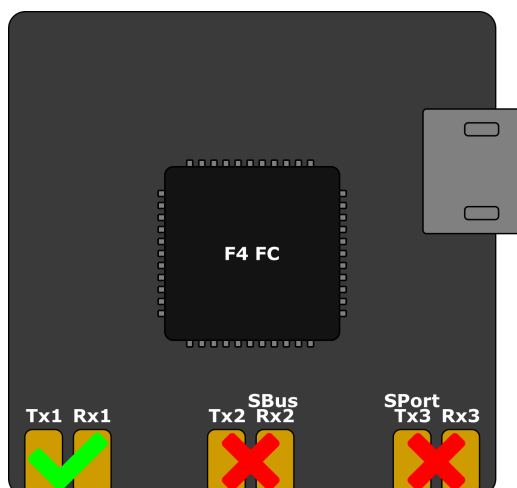

If you use a **F4 FC**, make sure you don't use UART's with labels with *SBUS* or *S-PORT*. Those UART's got a hardware-inverter installed which does not work with CRSF.



## CRSF with BetaFlight and similar firmwares

In the BetaFlight configurator, navigate to the *Configuration* tab and select *Serial-based receiver* and *CRSF*

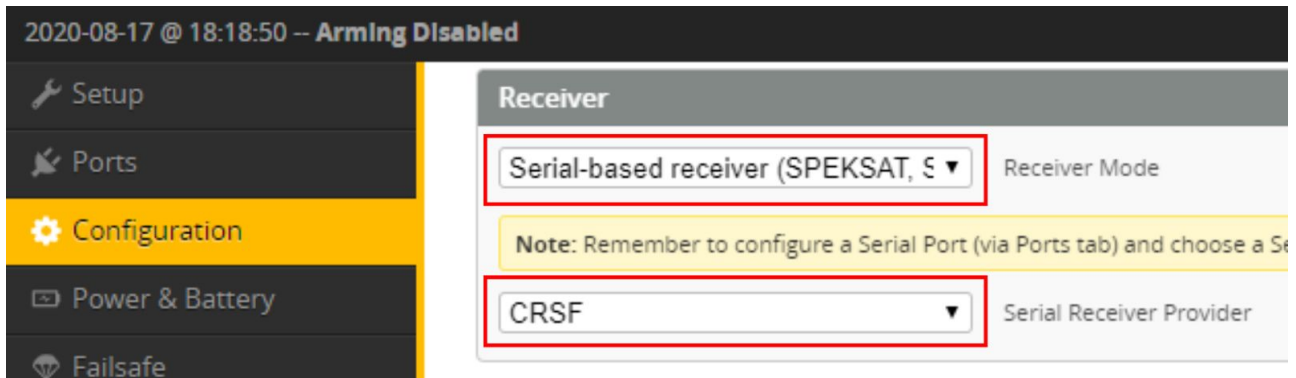

2020-08-17 @ 18:18:50 -- Arming Disabled

Setup  
Ports  
Configuration  
Power & Battery  
Failsafe

Receiver

Serial-based receiver (SPEKSAT, 5) Receiver Mode

Note: Remember to configure a Serial Port (via Ports tab) and choose a Serial Receiver Provider

CRSF Serial Receiver Provider

In the Ports tab, enable Serial Rx for the UART where your receiver is connected

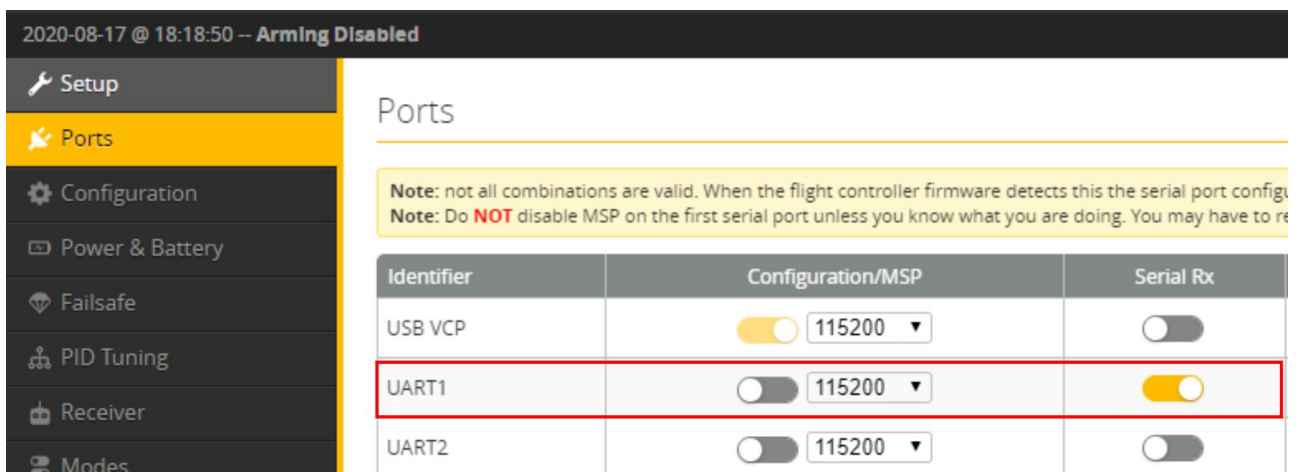

2020-08-17 @ 18:18:50 -- Arming Disabled

Setup  
Ports  
Configuration  
Power & Battery  
Failsafe  
PID Tuning  
Receiver  
Modes

Ports

Note: not all combinations are valid. When the flight controller firmware detects this the serial port configuration will be reset.  
Note: Do NOT disable MSP on the first serial port unless you know what you are doing. You may have to reflash the firmware.

Identifier	Configuration/MSP	Serial Rx
USB VCP	<input checked="" type="checkbox"/> 115200	<input type="checkbox"/>
UART1	<input type="checkbox"/> 115200	<input checked="" type="checkbox"/>
UART2	<input type="checkbox"/> 115200	<input type="checkbox"/>



## CRSF with KISS/ FETTEC

Depending on the KISS Fc you are using, connect the Crossfire by CRSF to the Fc's RC input port.

In the configurator, enable CRSF as RC Type:

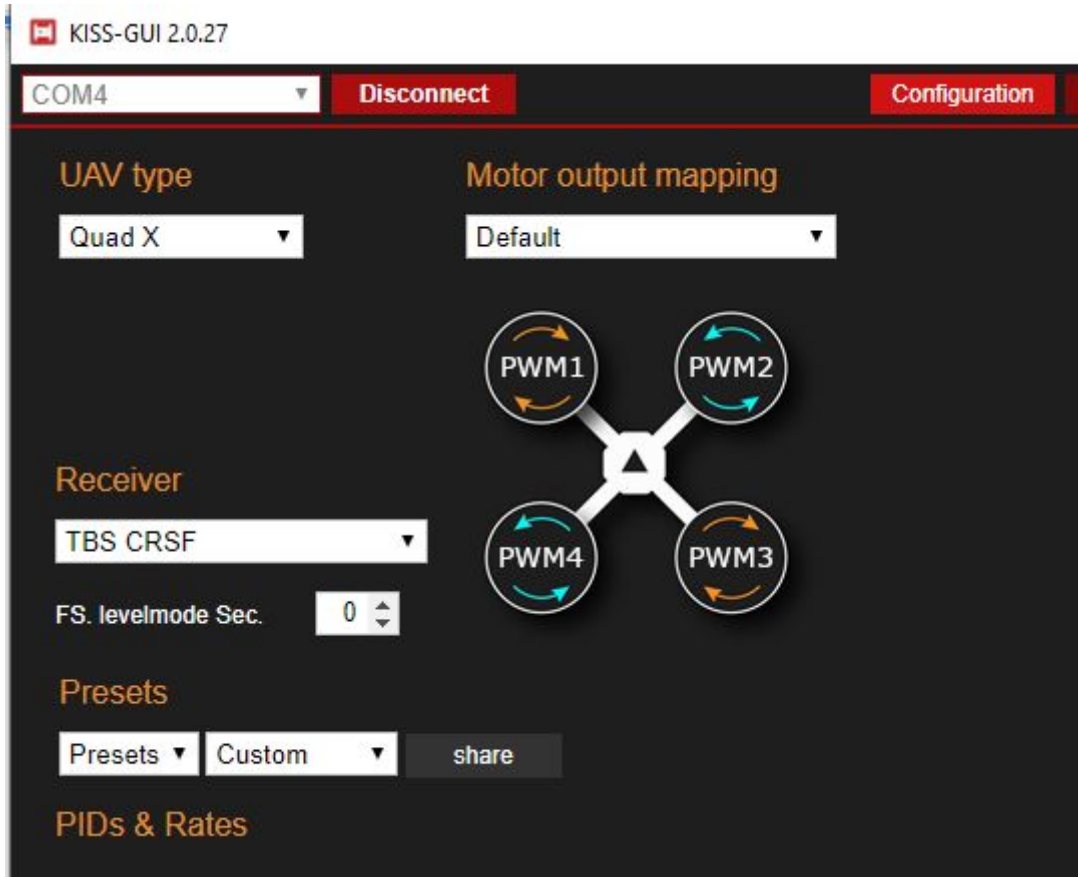

## Any other FC

Depending on your FC, set the output map according to the protocol that it can use.



## BST to Eagletree Vector

If you use an EagleTree vector Fc, you can connect the ET bus to the BST bus to get LQ and RSSI in the osd as well as telemetry from the FC back into the Crossfire.

To wire it up, just connect *SCL to SCL* and *SDA to SDA*. A common ground should already exist by the RC connection to the FC.

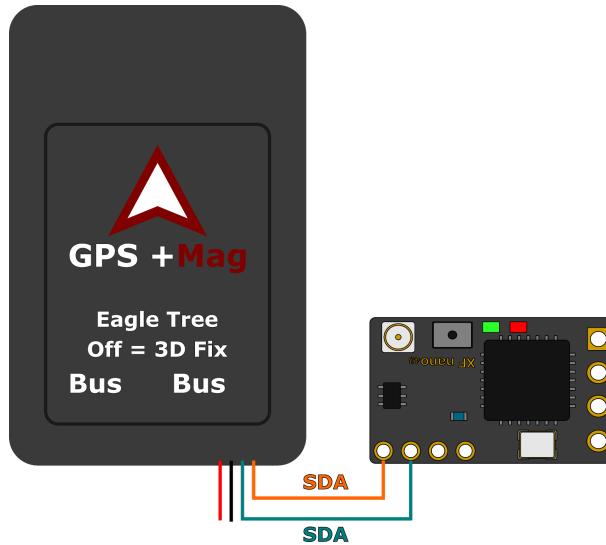

## Mavlink with MAV FC's

If you use a FC with MAVLink like ArduPilot/ PX4, you can use the MAVLink capabilities of the Crossfire. Connect a MAVLink capable output to the Telemetry port of your FC. On PIX FC's it's mostly the TELEM1 port and set the Crossfire Rx output map to MAVLink Tx and Rx.

Output 1	CRSF TX
Output 2	CRSF RX
Output 3	MAVLink Rx
Output 4	MAVLink TX
Output 5	BST SDA
Output 6	BST SCL

On the FC you need to configure the telemetry port. Otherwise the Crossfire will not be able to receive telemetry data from the fc until you connect it to Mission Planner. Your *TELEM1* can be found as *SR1*



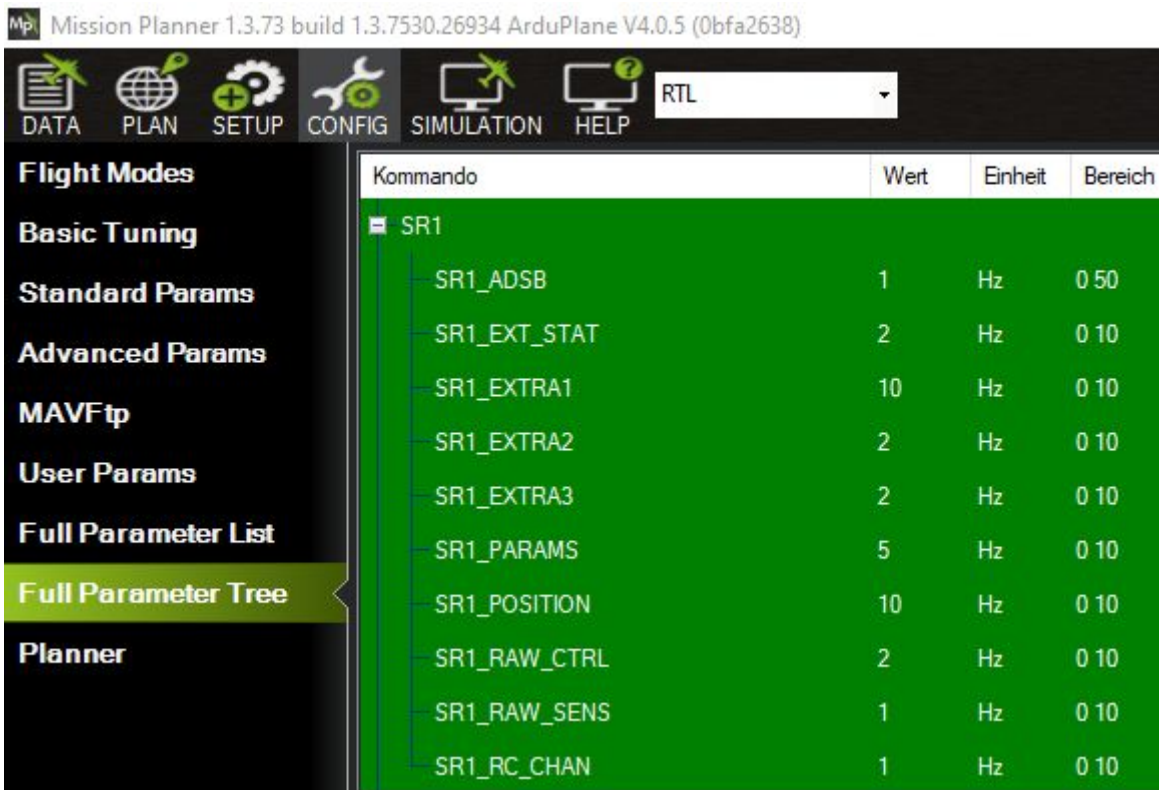

If you use MAVLink, you can also use the *RC over MAVlink* option to save the extra wiring. The details can be found [in this section](#).

If you use the PX4 firmware, you don't need to configure the telemetry port to get it running.

## Wireless configuration with ArduPilot/ PX4 by Bluetooth

As soon as the receiver receives valid MAVLink packages, the Bluetooth module switches to MAVLink as well. If you encounter issues, you can check the module settings in the *Transmitter/ General* settings:

Multi-Bind	Enable
Regio	Open
Max Power	25mW
Dyn. Power	On
Frequency	868MHz
Op. Mode	Nomal
Bluetooth	MAVLink
Factory Reset	

In [Mission Planner](#), [QGroundControl](#) or any other app, set the Baud Rate of your pc's Bluetooth module to **57600baud**.

Make sure your Crossfire RF profile is set to dynamic or forced 150Hz!



## Wireless configuration with ArduPilot/ PX4 by WiFi

Over the built-in WiFi module you can get MAVLink data to your pc or mobile device for live telemetry as well as full MAVLink data transmission (as with the bluetooth module).

You need to [set up your wifi module](#) for that to work before.

You can connect to your Crossfire in two ways:

- Both are in the same WiFi network
- Straight connection to the Crossfire access point

When you are connected, you need to use the following settings:

- **Connection type:** UDP
- **Port:** 8888

The port can be changed in the settings of the WiFi module, if you need to.

With WiFi FW 1.17 you can enable or disable the MAVLink data. To change this, navigate to and set *MAVLink* to *on*.

Make sure your Crossfire is in RF mode *dynamic* or *forced 150Hz*.

*Note: in 1.17 there is a bug which turns the Mavlink option off everytime time you shut your transmitter down*

### Wiring diagram

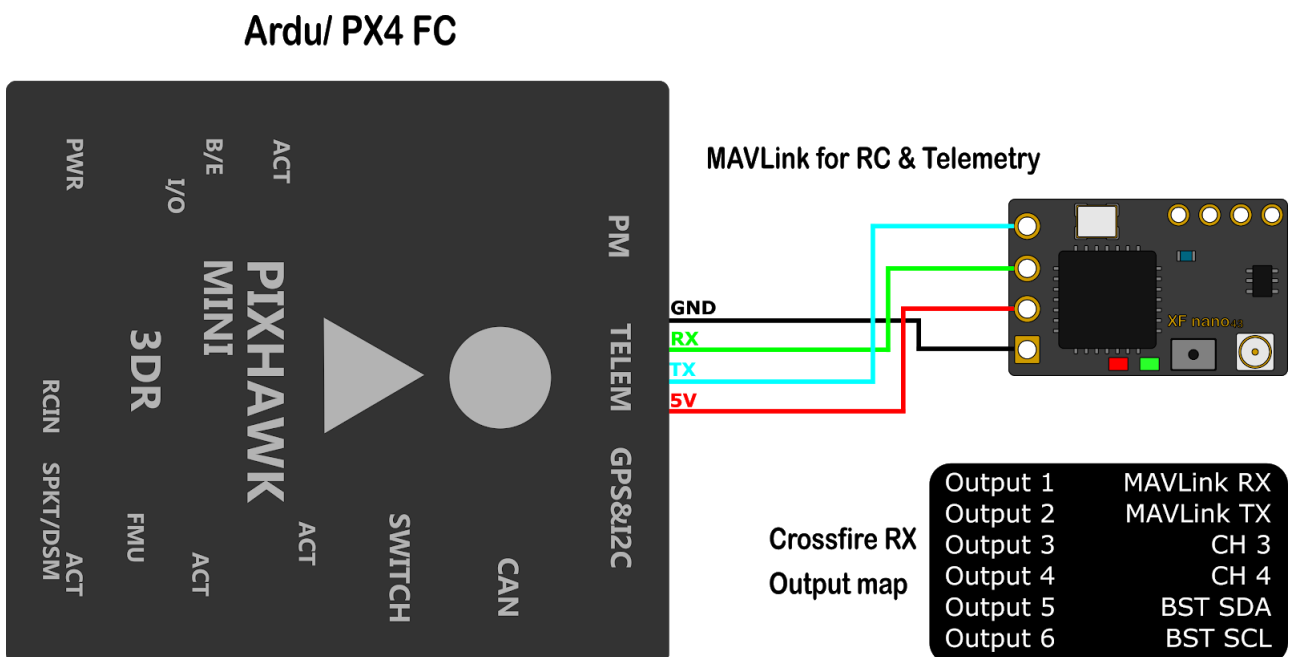

---

## Wireless telemetry

### Bluetooth

Depending on the FC firmware you use, you have to set your Bluetooth module to MAVEmu or Mavlink.

Use MAVEmu if you use a non-MAVLink fc firmware. Otherwise the Crossfire will set the Bluetooth module to MAVLink by itself (if MAVLink datas are incoming to the receiver).

Then connect your mobile device to the Crossfire Bluetooth module. The connection speed needs be set to **57600baud**

Depending on the app you are using, you might not need to be in 150Hz mode at the beginning.

### WiFi

Getting real-time telemetry data from your Crossfire by WiFi works almost the same as with Bluetooth.

You can find the WiFi details [here](#). Depending on the app you are using, you might not need to be in 150Hz mode/ dynamic rf mode at the beginning.

In the WiFi settings, you you enable the MAVLink stream first:



## WiFi telemetry with BetaFlight/ INav

For the WiFi telemetry, you need to wire up your FC with a extra MAVLink connection, as the MAVLink emulation is not (yet) supported by the WiFi firmware:

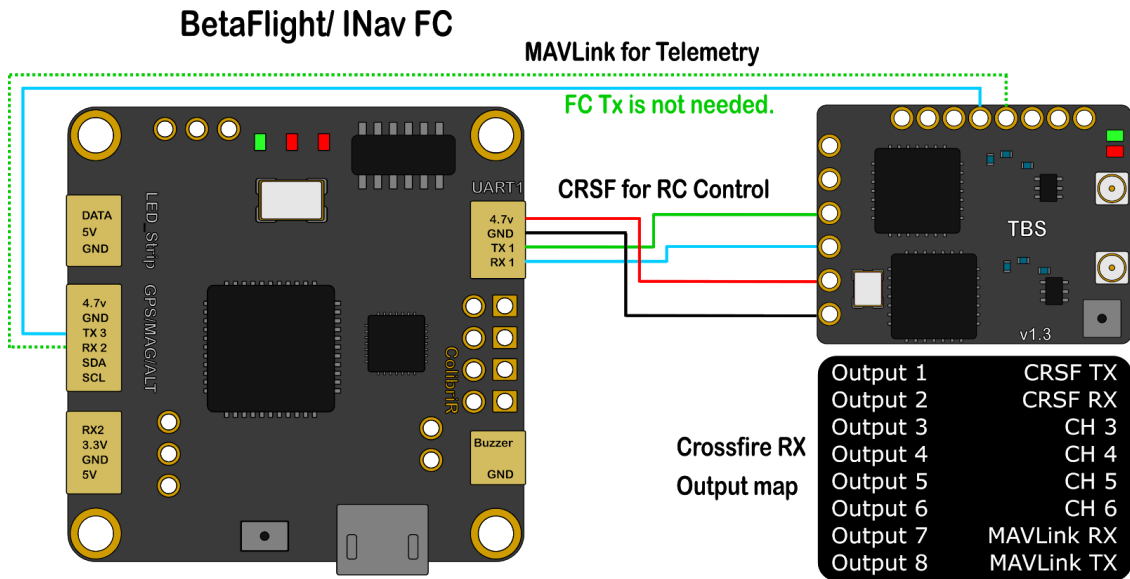

## Settings in BetaFlight/ INav

On the port where you got your extra MAVLink connection installed, enable **MAVLink** with **57600Baud** in the *PORTS* tab for that UART.

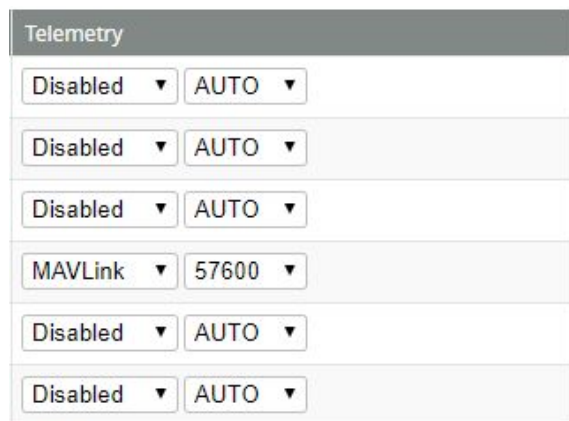

*Note: You need to cancel the "loading parameter" dialog in MissionPlanner etc, as it will not get past this dialog. The important telemetry data will be sent anyway.*





## Wireless configuration with BetaFlight/ Inav by Bluetooth

With the serial passthrough function of the Bluetooth module (Standard tx only) you can connect to your BetaFlight/ Inav Fc without the for a USB connection. For this to work, you need to connect a second connection between the Crossfire Rx and the FC

*Note:*

*This will only work while your Crossfire is in the 150hz mode. As soon as the link switches to 50Hz, the Bluetooth module stops sending serial data*

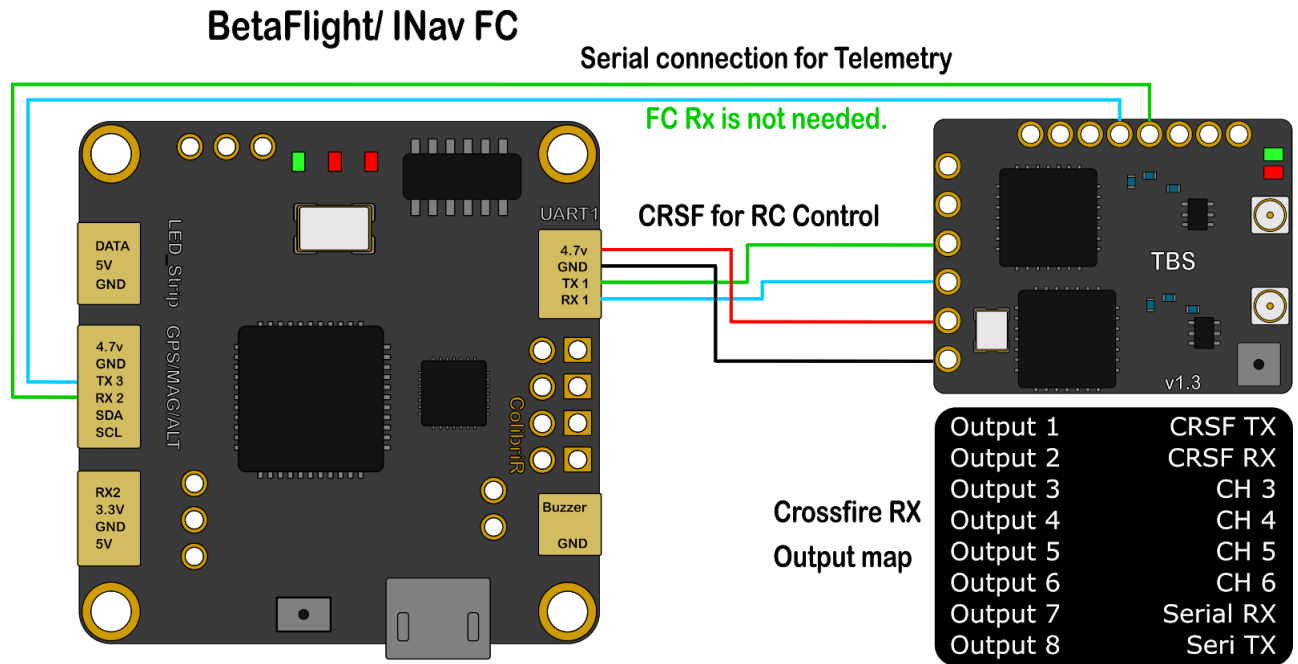

## Betaflight/ Inav setup

Enable MSP for the UART and set the Baud Rate to 57600. When you want to connect to the Betaflight/ Inav configurator, select the Com port of your pc and set the Speed to 57600baud as well.

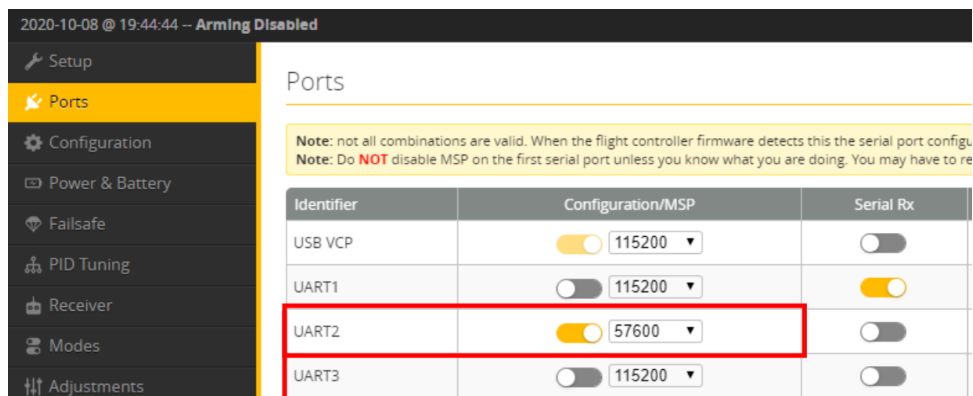

Enable MSP  
for the UART



## Signal strength in Betaflight - BF < 4.1 and DJI OSD

If you use an older BetaFlight version or a new one but with a DJI HD system, you need to assign the LQ sensor to a channel.

*Keep in mind, that the LQ will remain at 100% while the Crossfire is in 150Hz mode!*

Dst. Ch. 1	CH1
Dst. Ch. 2	CH2
Dst. Ch. 3	CH3
Dst. Ch. 4	CH4
Dst. Ch. 5	CH5
Dst. Ch. 6	CH6
Dst. Ch. 7	CH7
Dst. Ch. 8	LQ

In the Crossfire receiver channel mapping, assign LQ to an unused channel. If you set it up by LUA, you can assign it to channel 1, even when you use the 8 channel mode of the crossfire.

In BetaFlight, set the assigned channel as *RSSI Channel* (AUX1 = channel 5, etc)

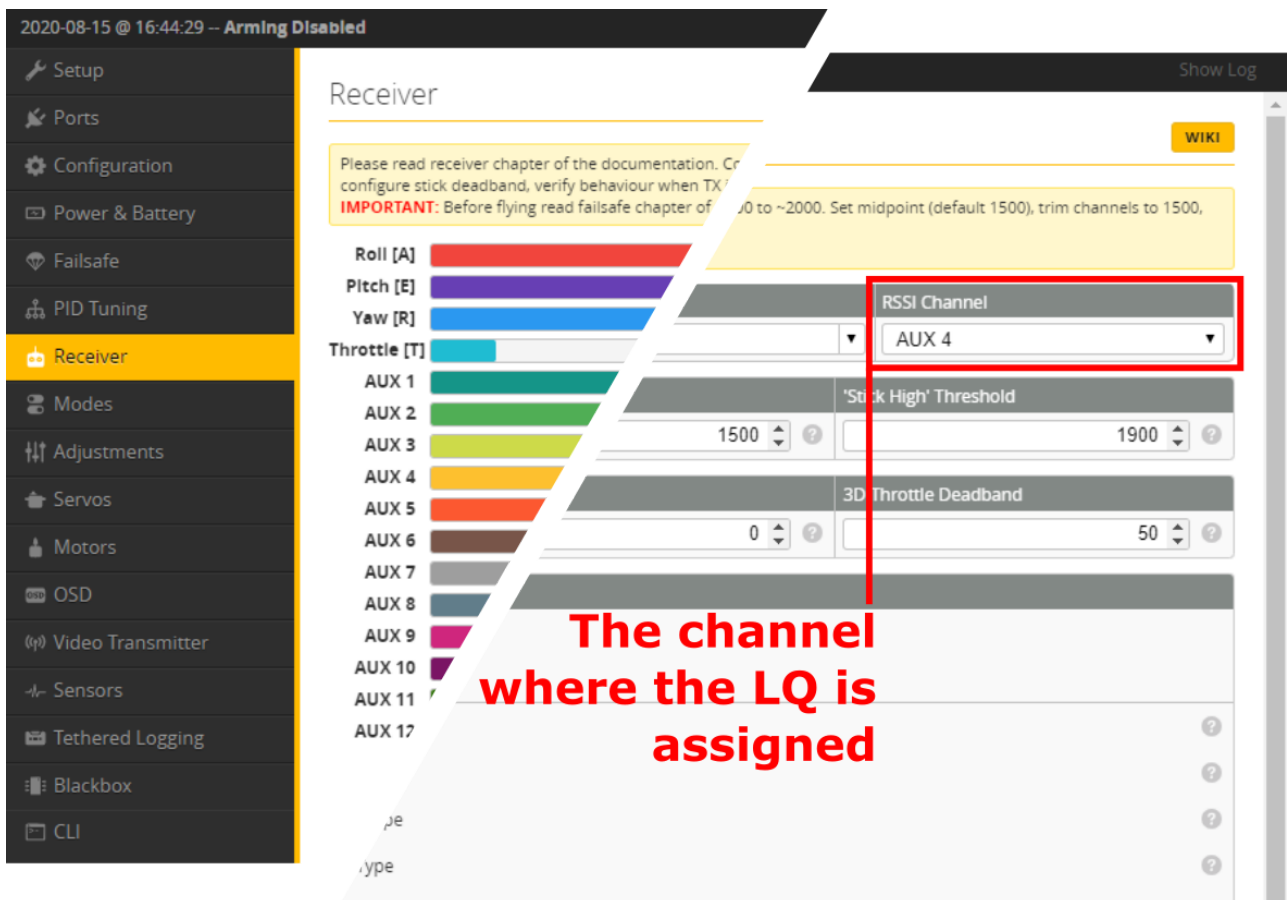

The screenshot shows the Betaflight Receiver configuration page. The left sidebar contains various settings categories, with 'Receiver' highlighted. The main area displays the 'Receiver' configuration, including a warning about reading the documentation and an important note about failsafe settings. The 'RSSI Channel' dropdown menu is highlighted with a red box and set to 'AUX 4'. Below this, there are settings for 'Stick High' Threshold and '3D Throttle Deadband'. A red arrow points from the 'RSSI Channel' dropdown to the text 'The channel where the LQ is assigned'.

**The channel where the LQ is assigned**



For the OSD tab, set it up like this:

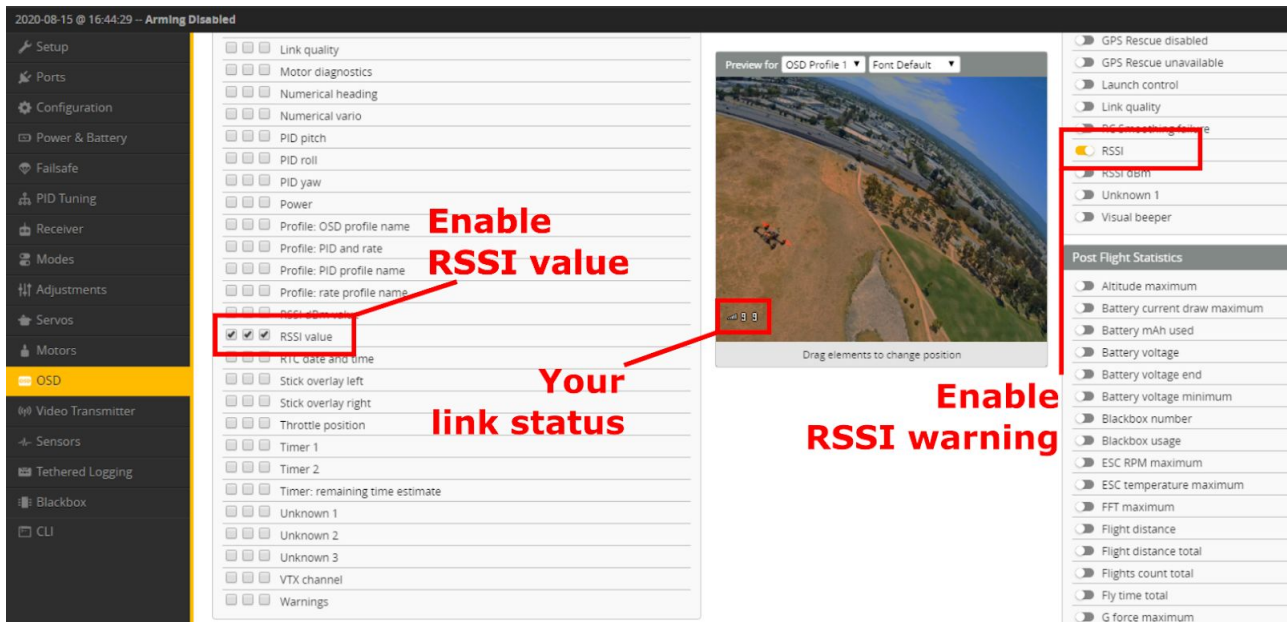

## Signal strength in Betaflight - BF 4.1 and later

Since version 4.1 BetaFlight can read the link information from the CRSf stream. This will give you the RSSI reading in dBm (0 - -130) and the LQ reading similar to the TBS OSD (300 - 0 %).

To use this new method, you need to disable the RSSI channel setting in the receiver tab and activate the following elements in the *OSD* tab.

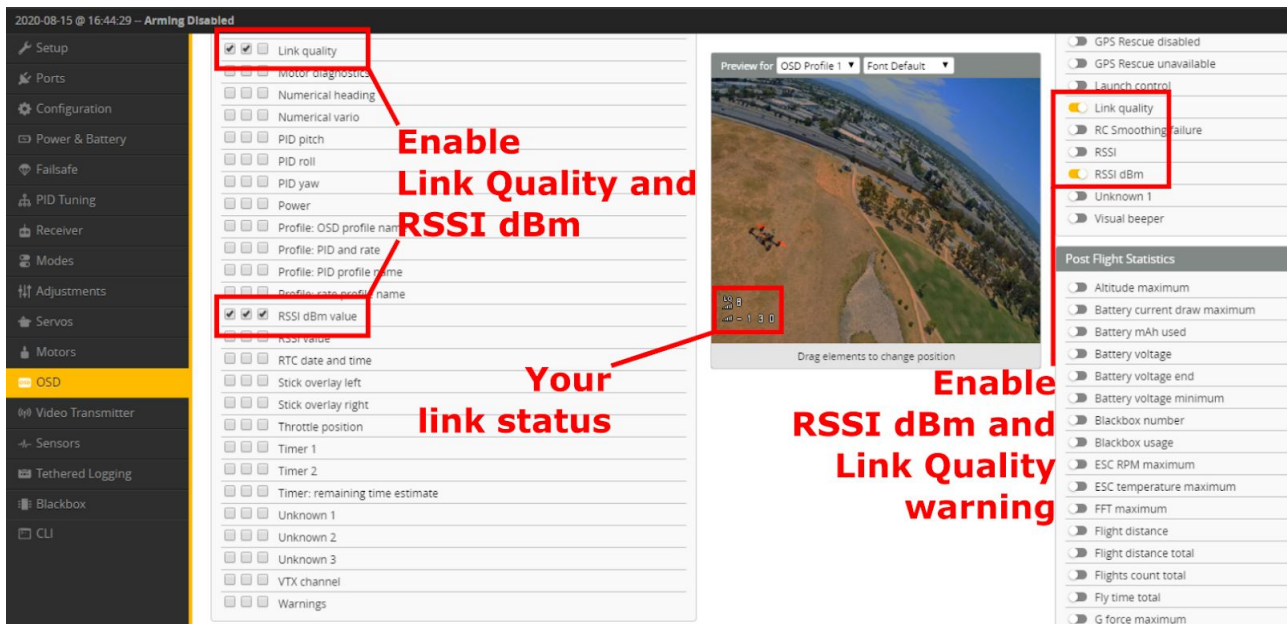

---

## Signal strength in INav

In INAV it's almost the same as with the old BetaFlight method, except that you don't need to assign LQ to a channel in the channel map menu.

INav reads the LQ from the CRSf stream and outputs it automatically on **Channel 17** (from INav).

## Link States

### LQ

Link quality

The number of packages that arrive correctly. If the number starts to drop, more packages are lost.

In the TBS OSD's the LQ is scaled from 0-300%:

- **0-100%:** 50/4 Hz mode
- **170-300%:** 150Hz mode

If you use LQ as sensor by the channel/ output map menu or as OpenTx telemetry sensor, it behaves like this:

- **150Hz mode:** 100%
- **50/4Hz mode:** 0-100%

### RSSI

Relative signal strength indicator

How "loud" the signal is, that the receiver "hears". But this also includes noise.

The RSSI is exponential which results in a massive drop at the beginning and slows down the lower it gets.

In general: double the range will result in a drop of -6dBm. An example:

- RSSI at 0m = -10dBm
- RSSI at 1m = -16dBm
- Rssi at 2m = -22dBm

The Crossfire can go down to -130dBm before the link breaks up.

If you use RSSI as sensor by the channel/ output map menu or as OpenTx telemetry sensor, it will be shown like this:

- **-0.1dBm** = 100%
- **-130dBm** = 0%



---

## SNR

Signal-to-Noise ratio

It shows you the ratio between the received noise and your Crossfire signal.

To judge RSSI properly you need to know the SNR and compare it with your RSSI value. The Crossfire can receive signals in the noise down to -6dB.

Example:

A RSSI of -80dBm is fine. But with a SNR of -2dBm it's really bad.

Positive numbers mean the Crossfire signal is "louder" than the noise,  
negative Numbers mean the noise is louder than the Crossfire

## Warning levels

Sensor	Prewarning	Critical
RSSI	30% / -100dBm	20% / -106dBm
LQ	70% (BF: 1:70)	60% (BF: 1:60)
RSSI/ LQ	30%	20%
SNR	4dB	0dB

## What should i use in my OSD or radio

The easiest way to set up your OSD or radio warning is by **using LQ**. It is linear which makes it easier to monitor for most of the people, while RSSI got a logarithmic scaling which makes it drop rapidly at the beginning and then slower the further you go.



## Racing environment

When using TBS CROSSFIRE control link, it is a requirement that all pilots use exactly the same power output. Use of CROSSFIRE has the same requirement as management of video transmission power output when it comes to racing.

Recommended settings:

- **Max output power:** 100mW/ 25mW (depending on your local laws)
- **Dynamic power:** off
- **RF profile:** dynamic or forced 150Hz
- **Telemetry:** off (saves bandwidth for other pilotes)
- **Frequency:** 868/915 RACE

If you use forced 150Hz, your race director can see your power output on the LED color of your transmitter.

The available color codes can be found [here](#).

## Factory reset

If you experience a strange behavior with your Crossfire, a factory reset can help solve them.

The process is the same for all transmitters and receivers:

- Power up your device
- Navigate in to the transmitter or the receiver menu
- Under "General" you can find the "Factory reset" option
- When you started it, follow the instructions on your display/ radio
- When the reset is finished, **you need to power cycle your device**

If you did the reset for the receiver you need to rebind it by pushing the *Bind* button.

**Check and adjust your settings after the power cycle. Everything will be set to default.**

**On the receiver the failsafe position must be teached again if you want to use it!**

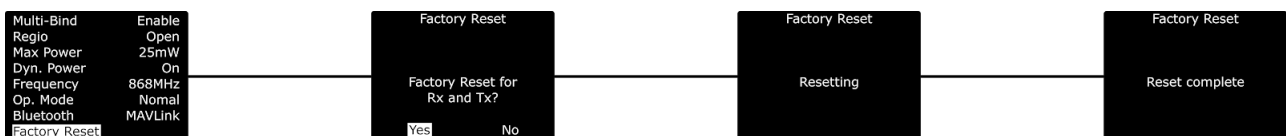

---

## Emergency Update

If an OTA update for the receiver fails, it will no longer work. In this case you need to use the built-in emergency update feature:

### Standard Diversity Rx

The standard diversity receiver comes with an onboard usb connection. Therefore you can connect the receiver with you TBS Agent X and update him straight away.

### Micro/ Nano/ Nano Diversity Rx

Since FW 2.24 the Crossfire receivers stores a specific, "golden" firmware inside, which can be restored by the following steps:

- Hold the bind button
- Power up the receiver
  - The led on the rx starts to flash rapidly
- Release the button
- Push and hold the button again
  - The led will start to blink in a double-patter
- As soon as the led switches to rapid flashing again, you can release the button
- When the pattern changes back to slow, single blinking the emergency update is finished

Now the receiver is working again and automatically turned on the bind mode. Now you can power up your transmitter, start the binding and run the OTA update again



---

## FLARM

FLARM is a collision-avoidance system developed in the swiss and mainly used by sailing planes and helicopters. With the TBS Crossfire you are able to send and receive the FLARM track signal and make the airspace a bit safer.

FLARM ist ein Kollisions-Vermeidungssystem, dass von Segelfliegern und anderen privaten Leichtflugzeugen genutzt wird. Mit dem TBS CROSSFIRE kannst du dein Modell mit der gleichen Technik auszustatten.

### What you need

The needed license and hardware base depends on what you want to do. In general you need the TBS GPS puck (the one in the black enclosure, not the cheap small m8n GPS!) and a standard diversity receiver (the nano diversity receiver is not yet supported).

Beside of this you need to make sure that you use an up-to-date Crossfire firmware as the FLARM license expires and gets updated with the Crossfire updates. As an example FW 4.05 will expire on 01.06.2021

### Just send

If you want to just send your FLARM track to other pilots and the FLARM capable ground stations, no license is needed. Just the TBS GPS connected by BSt to the Crossfire Rx

### Receive

If you want to receive the position of other pilots, you need a license. There are two licenses available:

- **Buddy:** See other Crossfire pilots that got there FLARM activ
- **Aviation:** Receive and see other Crossfire pilots as well as real airplanes and helicopters

### Show on the OSD

To see other pilotes in your OSD you need to get a TBS Core Pro or FPVision OSD beside of the above mentioned licenses.

### Note:

If you purchased and activated a license, you can see the other pilots in Mission Planner without the need for an OSD. They will be displayed as airplanes. This in general is useful if you got a spotter watching the sky and air traffic for you.

### Getting a license

You can purchase your license and some bundles on the [TBS shop](#). After the purchase you will receive an





email with your code to unlock the feature.

Each license is bound to the receiver and can not be transferred to another receiver! If you lose or sell your receiver, the license is also gone!

If you lost the email with the key, open a ticket, including the receiver serial number.

## Activation of a license

When you receive your email with the code, you need to get the [old TBS Agent](#) (Agent X is in development for this). After the installation:

- Connect the Crossfire diversity rx via USB with your Pc
- Open the Agent
- Ignore the message from the Agent (Device not recognised. Update now?)
- Navigate to the *License* tab
- Enter the license in the desired field and hit enter
- Now you should see *Activated Licenses: 1. FLARM Buddy (or aviation)*

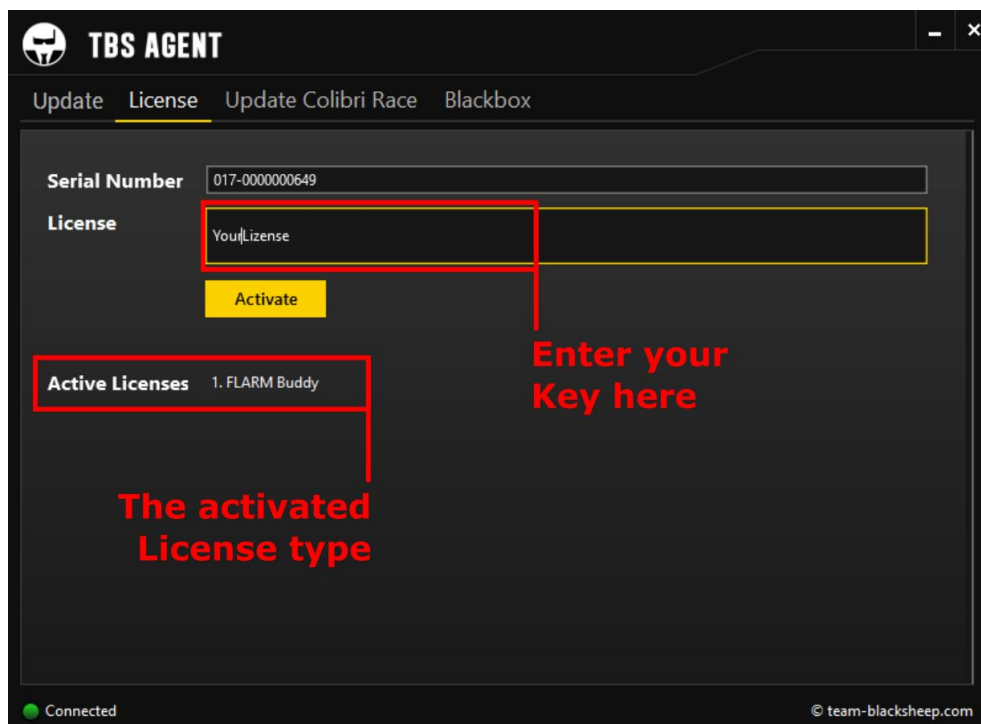

---

## Status display

If you own a Standard or Lite Tx, you can see the actual status of your FLARM setup in one of the main screens of the Oled display:

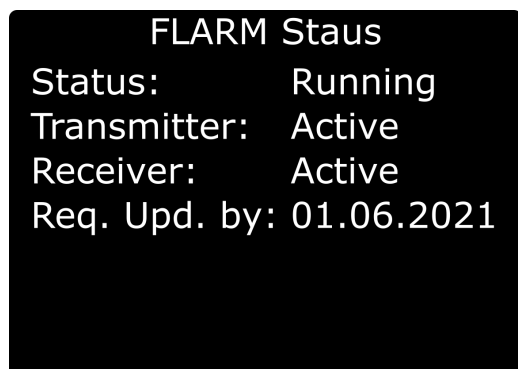

**Status:** no Sat Fix/ Fix - are enough satellites found by the GPS

**Transmitter:** Active/ Inactive - #TODO

**Receiver:** Active/ Inactive - Active if a license is installed

**Req. Upd. by:** XX.XX.XXX - Will be updated by the Crossfire updates

## Settings

You can find the FLARM settings under *Diversity Receiver/General*:

### FLARM

Here you can set up which pilots you want to see (OSD and Mission Planner) and if you want to send you position to other pilots as well:

- Off: No FLARM data will be send or received
- Pulse: Just send out your position
- Buddy: Send your position and show Crossfire pilots (only available with active license)
- Aviation: Send your position and show Crossfire pilots and airplanes and helicopters (only available with active license)

### Flarm Track

- Off/ On - Send your data to the ground stations. If activated you can be seen on maps like the one from [OpenGliderNetwork](#).

### OSD

If you own a TBS Core Pro or a FPVision OSD, they can show you the received pilots in a radar which scales by itself. If no other pilot is found, the radar will disappear and come back when a new pilot is found.

The shown Types depend on your license and the FLARM setting you have set up before.





Your aircraft is the center of the radar. Each airplane type got there own symbol so you know what is spotted:



- Arrow:** Crossfire pilots
- Airplane:** manned Airplane
- Helicopter:** manned Helicopters

### Flarm in action

We made a video showing you how the FLARM integration of the TBS Crossfire works:

[FLARM Showcase](#)



---

## FAQ

Some common and some special outlier questions for the CROSSFIRE system.

- Droidplanner can't connect to wireless close range telemetry module
  - Try to use DroidPlanner 2 only for MAVLink emulator not the Tower app
  - Go under settings and make sure connection type is set to Bluetooth
  - Go under Settings -> Advanced -> Connection Preferences and press forget default device
- TBS CROSSFIRE Seems not to work with Futaba T18SG
  - It required you use an external battery to power the TBS Crossfire
  - Go to Trainer port settings and select ACT, Student and 8 Ch. or 12 Ch.
- Does the transmitter forget the receiver when I bind a new receiver
  - No. The receiver stores the serial number of the transmitter. Everything is based on this. So you can bind as many receivers as you want.
- What happens if I have more than one receiver running at time
  - We recommend to run only one receiver at time but if you like to, you can run more than one receiver at time. As the system is not designed for this use case some features need to be disabled to make it work properly. Make sure both receivers run in the same operation mode, 8 or 12 channel mode and both have telemetry disabled.

Manual written and designed by [ivc.no](http://ivc.no) in cooperation with TBS, redesigned and maintained by [kamikatz-fpv.de](http://kamikatz-fpv.de)

