

## Air to water heat pump UNITHERM 4 SPLIT R32

### **Service manual**

Models:

CH-HP4.0SIRK4  
CH-HP6.0SIRK4  
CH-HP8.0SIRK(M)4  
CH-HP10SIRK(M)4  
CH-HP12SIRK(M)4  
CH-HP14SIRK(M)4  
CH-HP16SIRK(M)4

Thank you for choosing our product.  
Please read this Owner's Manual carefully before operation and retain it for future reference.  
If you have lost the Owner's Manual, please contact the local agent or visit  
[www.cooperandhunter.com](http://www.cooperandhunter.com).

# Contents

<b>Product Data .....</b>	<b>1</b>
<b>1 Product Data .....</b>	<b>1</b>
1.1 Lineup .....	1
1.2 Nomenclature.....	2
1.3 Product Features .....	3
1.4 Operating Principle .....	6
1.5 Technical Data .....	7
<b>2 Explosive Views and Part Lists.....</b>	<b>26</b>
<b>3 Supply Scope.....</b>	<b>41</b>
<b>Model Selection .....</b>	<b>42</b>
<b>1 General .....</b>	<b>42</b>
1.1 Power Supply.....	42
1.2 Operation Conditions .....	42
1.3 Flowchart of Model Selection.....	42
1.4 Design Principle .....	42
<b>2 Selection of the Underfloor Coils.....</b>	<b>43</b>
2.1 Calculation of Unit Load for Floor Heating .....	43
2.2 Selection of Tube Spacing of the Underfloor Coils .....	43
2.3 Selection of Loop Quantity of Coils for Each Room.....	43
<b>3 Quantity and Location of the Water Manifold .....</b>	<b>44</b>
3.1 Design Requirements on Loop Quantity for Circulation Water .....	44
3.2 Requirements on Installation of the Water Manifold .....	46
<b>4 Section of FCU.....</b>	<b>46</b>
4.1 FCU Type Selection .....	46
4.2 Matching of Capacity .....	46
<b>5 Selection of the Water Tank.....</b>	<b>47</b>
5.1 Specifications of the Water Tank.....	47
5.2 Volume Selection of the Water Tank.....	47
<b>6 Examples for Model Selection.....</b>	<b>48</b>
6.1 General Introduction to the Example Project .....	48
6.2 Heat Load Calculation.....	48
6.3 Model Selection .....	49
<b>Control.....</b>	<b>50</b>
<b>1 Integral Control Concept .....</b>	<b>50</b>

1.1 Control Principle Diagram .....	50
1.2 Control Flowchart.....	53
<b>2 Main Control Logics .....</b>	<b>53</b>
2.1 Cooling.....	53
2.2 Heating.....	54
2.3 Water Heating .....	54
2.4 Shutdown .....	55
2.5 Control to the Compressor.....	55
2.6 Control to the Fan .....	55
2.7 Control to the 4-way Valve .....	55
2.8 Control to the Water Pump .....	55
2.9 Control the Electronic Expansion Valve .....	56
2.10 Protection Control .....	56
<b>3. Control Panel .....</b>	<b>56</b>
3.1 General .....	56
3.2 Operation Instructions.....	59
3.3 Intelligent Control .....	87
<b>UNIT INSTALLATION .....</b>	<b>95</b>
<b>1. Installation Guides .....</b>	<b>95</b>
1.1 Installation Position .....	95
1.2 Matters Need Attention .....	96
<b>2 Field Supplied Pipes and Valves.....</b>	<b>96</b>
<b>3 Service Tools .....</b>	<b>97</b>
<b>4 Installation Instructions .....</b>	<b>98</b>
4.1 Installation Examples .....	98
4.2 Pre-Installation .....	100
4.3 Selection of Installation Location .....	100
4.4 Installation of Outdoor Unit .....	100
4.5 Installation of Indoor Unit .....	106
4.6 Connection of Pipeline .....	110
4.7 Installation of Water Tank.....	113
4.8 Requirements on water quality .....	120
4.9 Electric Wiring .....	120
4.10 Wiring of the Terminal Board .....	125
4.11 Wiring of the 2-Way Valve .....	128
4.12 Wiring of Other Thermal.....	129



4.13 Wiring of the Gate-Controller .....	131
4.14 Wiring of the Remote Air Temperature Sensor .....	132
4.15 Wiring of the Thermostat.....	133
4.16 Wiring of the Control .....	134
<b>5 Commissioning and Trial Run.....</b>	<b>135</b>
5.1 Check before startup.....	135
5.2 Trial run .....	136
<b>TEST OPERATION &amp; TROUBLESHOOTING &amp; MAINTENANCE.....</b>	<b>137</b>
<b>1 Precheck.....</b>	<b>137</b>
1.1 Check for Wiring .....	137
1.2 Check for the Water System .....	137
1.3 Check for the Communication System.....	138
1.4 Trial Run.....	139
<b>2 Error Code List .....</b>	<b>139</b>
<b>3 Flow Chart of Troubleshooting .....</b>	<b>141</b>
3.1 Compressor High-pressure Protection E1 .....	141
3.2 Compressor Low- pressure Protection E3 .....	142
3.3 Compressor Discharge Temp Protection E4.....	142
3.4 Overload Protection of Compressor or Driver Error.....	143
3.5 DC Fan Error EF .....	143
3.6 Temperature Sensor Error .....	144
3.7 Communication Malfunction E6 .....	144
3.8 Capacity Switch Error (Code:"C5") .....	145
<b>4 Diagnosis of Drive .....</b>	<b>145</b>
4.1 Diagnosis Flowchart of Drive of Single-phase Unit and Three-phase Unit.....	145
<b>5 Daily Maintenance and Repair.....</b>	<b>149</b>
5.1 Daily Maintenance .....	149
5.2 Troubleshooting .....	149
5.3 Repair .....	150

## Product Data

### 1 Product Data

#### 1.1 Lineup

##### 1.1.1 Main Unit

Series	Model	Product Code	Cooling Capacity (kW)	Heating Capacity (kW)	Power Supply	Refrigerant	Appearance
UNITHERM 4	CH-HP4.0SIRK4	ER01001510	3.8	4	230VAC, 50Hz	R32	
	CH-HP6.0SIRK4	ER01001500	5.8	6			
	CH-HP8.0SIRK4	ER01001480	7	8			
	CH-HP10SIRK4	ER01001750	8.5	9.5			
	CH-HP12SIRK4	ER01002000	11	12			
	CH-HP14SIRK4	ER01002020	12.6	14			
	CH-HP16SIRK4	ER01002010	13	15.5			
	CH-HP8.0SIRM4	ER01001810	8.5	8			
	CH-HP10SIRM4	ER01001840	10	10			
	CH-HP12SIRM4	ER01001980	11	12			
	CH-HP14SIRM4	ER01001990	12.6	14			
	CH-HP16SIRM4	ER01002030	13	15.5			

##### 1.1.2 Water Tank

Model	Product Code	Nominal Cubage(L)	Appearance
SWT300C3EK	ER20000350	300	

## Air-to-water Heat Pump Split Unitherm

Model	Product Code	Nominal Cubage(L)	Appearance
SWT300P3EM	ER01002460	300	
SWT300P3EK	ER20000370		

### 1.2 Nomenclature

#### 1.2.1 Main Unit

CH	-	H	P	10	S	I	R	K	4	(I)		
1		2	3	4	5	6	7	8	9	10		

NO.	Description	Options
1	C&H	CH-Cooper&Hunter
2	Heating Mode	H= Heat
3	Heat Pump Water Heater	P=Water Pump
4	Nominal Heating Capacity	4.0=4.0kW; 6.0=6.0kW; 8.0=8kW; 10=10kW; 12=12kW;14=14kW; 16=16kW
5	Type	S=Single
6	Compressor Type	I=DC Inverter
7	Refrigerant	R=R32
8	Power Supply	K=220-240V,~,50Hz; M=380-415V,3N~,50Hz
9	Series	4=series
10	Indoor and Outdoor Unit Code	I=Indoor unit; O=Outdoor unit

#### 1.2.2 Water Tank

SWT	300	C	3	E	K						
1	2	3	4	5	6						

NO.	Description	Options
1	Heat pump water tank	SWT=Sanitary Water Tank
2	Nominal Water Tank Volume	200=200L,300=300L
3	Heat Exchanger type	C=coil; CD=double coil P=Plate Heat Exchanger
4	Nominal Power Heater	3=3kW
5	Heater Type	E=Electrical Heater
6	Power Supply	K=220-240V,~,50Hz; M=380-415V,3N~,50Hz

## 1.3 Product Features

### 1.3.1 General

It's a kind of integrated DC inverter unit that comprises cooling, heating and water heating functions, and up to 5.0 energy efficiency. It adopts R32 refrigerant and two-stage compressor. For heating, ambient temperature range is -25~35°C while the leaving water temperature range is 20~60°C.

The Unitherm 3 unit is designed specially for the European market where there is a demand for high-temperature water. Thanks to the dual-stage compression and enthalpy gain through gas injection, the heating energy efficiency at low temperature will rise up greatly with the leaving water temperature up to 60°C. The whole series of products strictly comply with EN14511, EUROVENT energy efficiency Class A and SCOP class A+++ (35°C), SCOP class A++ (55°C) with EN14825. Their COP can reach up to 5.0. This unit can realize space heating and sanitary hot water supply through terminal units, like the fan coil unit, floor coil and radiator. Environment-friendly refrigerant R32 is adopted for the unit, with ODP of 0 and quite low GWP (=675). Besides, the adopted heat pump technologies will reduce consumption of coal and other energy source and lower greatly CO<sub>2</sub> emission. Ranged from 4.0kW~9.5kW, it is widely applicable to small and medium-sized apartment, large-sized villa etc.

### 1.3.2 Features

◆ Wide Operation Range

Heating: -25~35°C; Cooling: 10~48°C; Water Heating: -25~45°C

◆ Unique Low-Temp Hi-heat Dual-stage Compressor

- (1) Under low-temperature conditions, compared with the conventional compressor, the dual-stage low-temp hi-heat compressor will generate less loss of heat capacity and get higher energy efficiency.
- (2) Floodback, high discharge temperature and other problems can be completely avoided under low-temp conditions and the compressor's reliability will be enhanced greatly.
- (3) Dual-stage compression, dual-stage throttling and intermediate enthalpy adding through gas injection will raise the leaving water temperature and improve the control accuracy.
- (4) Values of resistance to compressor status:  
 4/6kW—UV/VW/UW: 1.67±7%Ω  
 8/10kW—UV/VW/UW: 0.99±7%Ω

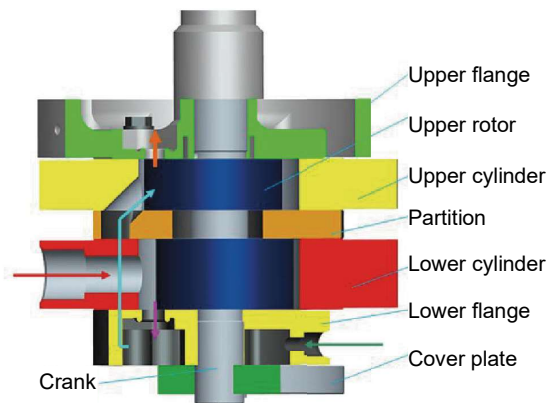

◆ High-efficiency Component (Inverter pump, Inverter fan, Plate heat exchanger)

- (1) The A-class high-efficiency inverter water pump which complies with the European ErP directive, can control the running frequency based on the actual load. Therefore, it can enhance the operation efficiency and control the water temperature more accurately.
- (2) The DC inverter fan can control the air volume accurately and make the system run more stably and save more energy.
- (3) The high-efficiency plate heat exchanger will improve the unit's performance largely.



(4) The high-efficiency water pump will also improve the unit's performance largely.



◆ All-in-one Design

- (1) The unit can integrate with terminal units, like the radiator, floor heating device, FCU, water heating device, solar kit, gas furnace etc. Versatile functions can meet various kinds of demands from different users and enhance applicability of this product.
- (2) The all-in-one structure design can save more installation cost, reduce risks of refrigerant leak, and improve safety and reliability of the system.

◆ Brand-new Controller

- (1) White appearance, exquisite design, and the wall-mounted design that facilitates installation.
- (2) Liquid crystal display and touch-screen operation.
- (3) The 12V JACK interface can supply power to the control separately and lengthen the communication distance.
- (4) The remote monitoring interface can monitor the unit through the Modbus interface and be integrated into the BMS system.



(Home page)





(Menu page)

◆ Smart Control, Powerful Function

- (1) The operating mode can be switched freely. Furthermore, based on different demands, the holiday mode, weather-dependent mode, quite timer, temperature timer and floor commissioning can activated.
- (2) Multiple protections can make this product much safer. The added electric heater will prevent the plate heat exchanger from being frosted owing to too low water temperature and resultantly extend the service life of the product and enhance its safety and reliability.
- (3) The newly developed smart defrosting control program, “do defrost when necessary; do not defrost when unnecessary; defrost more when it frosts heavily; defrost less when it frosts lightly”, can bring more comfortability, avoid inadequacy of heat supply and ensure sustainable heat supply for the users.

The flowchart with parameters to be set.

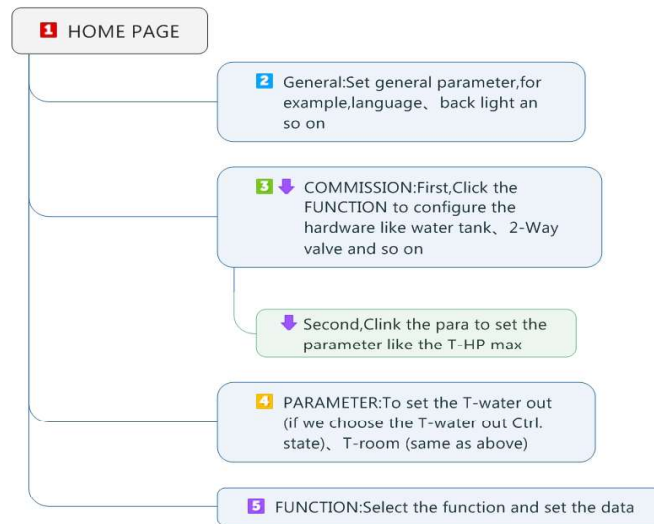



## 1.5 Technical Data

### 1.5.1 Parameter List

CH-HP _SIRK4			4.0	6.0	8.0	8.0(H5)	10	10 (H5)	
Product Code (ER010__ )			01510	01500	01480	02230	01750	02200	
Capacity*1	Cooling (floor cooling)	kW	3.8	5.8	7.0	7.0	8.5	8.5	
	Heating (floor heating)	kW	4.0	6.0	8.0	8.0	9.5	9.5	
Power Input*1	Cooling (floor cooling)	kW	0.80	1.32	1.75	1.75	2.24	2.24	
	Heating (floor heating)	kW	0.78	1.20	1.70	1.70	2.07	2.07	
EER*1(floor cooling)		W/W	4.75	4.4	4.0	4.0	3.8	3.8	
COP*1(floor heating)		W/W	5.1	5.0	4.7	4.7	4.6	4.6	
Capacity*2	Cooling (for Fan coil)	kW	3.15	4.09	5.3	5.3	6.5	6.5	
	Heating (Fan coil or Radiator)	kW	4	5.9	8	8	9.5	9.5	
Power Input*2	Cooling (for Fan coil)	kW	0.92	1.28	1.73	1.73	2.27	2.27	
	Heating (Fan coil or Radiator)	kW	1.02	1.51	2.14	2.14	2.64	2.64	
EER*2(for Fan coil)		W/W	3.4	3.2	3.0	3.0	2.9	2.9	
COP*2(Fan coil or Radiator)		W/W	3.9	3.9	3.7	3.7	3.6	3.6	
Refrigerant charge volume		kg	1.0	1.0	1.6	1.6	1.6	1.6	
Sanitary water temperature		°C	40~80°C						

Model CH-HP _SIRK4			12	14	16
Product Code (ER010__ )			02000	02020	02010
Capacity*1	Cooling (floor cooling)	kW	11	12.6	13
	Heating (floor heating)	kW	12	14	15.5
Power Input*1	Cooling (floor cooling)	kW	2.5	3.41	3.60
	Heating (floor heating)	kW	2.4	2.98	3.44
EER*1(floor cooling)		W/W	4.4	3.7	3.6
COP*1(floor heating)		W/W	5	4.7	4.5
Capacity*2	Cooling(for Fan coil)	kW	10.59	11.07	11.51
	Heating (Fan coil or Radiator)	kW	12.4	14.48	16.09
Power Input*2	Cooling(for Fan coil)	kW	3.79	4.18	4.49
	Heating (Fan coil or Radiator)	kW	3.29	3.93	4.44
EER*2(for Fan coil)		W/W	2.79	2.65	2.57
COP*2(Fan coil or Radiator)		W/W	3.77	3.68	3.62
Refrigerant charge volume		kg	1.84	1.84	1.84
Sanitary water Temperature		°C	40~80		





**1.5.3 Operation Range**

Item	Water Side	Heat Source/User Side
	Leaving Water Temperature (°C)	Environment Dry Bulb Temperature (°C)
Cooling	7~25	10~48
Heating	20~60	-25~35
Water Heating	40~80 (Water Tank Temperature)	-25~45

Note: when operating conditions are out of the range listed above, please contact C&H.

**1.5.4 Temperature sensor parameter**

Displayed Name	Inspection range(°C)	Nominal working datas			Remark
		Cooling	Heating	Hot water	
T-outdoor	-30~150	8~50	-27~37	-27~45	temperature sensor resistance 15K
T-suction	-30~150	5~30	-25~20	-25~30	temperature sensor resistance 20K
T-discharge	-30~150	30~102	35~102	35~102	temperature sensor resistance 50K
T-defrost	-30~150	20~57	-25~30	-25~40	temperature sensor resistance 20K
T-water in PE	-30~150	10~30	20~55	20~55	temperature sensor resistance 20K
T-water out PE	-30~150	5~25	25~60	25~60	temperature sensor resistance 20K
T-optional water Sen.	-30~150	5~25	25~60	25~60	temperature sensor resistance 50K
T-tank ctrl.	-30~150	/	/	10~80	temperature sensor resistance 50K
T-floor debug	-30~150	/	25~45	/	/
Debug time	-30~150	/	12~72	/	/
T-liquid pipe	-30~150	5~25	20~57	20~57	temperature sensor resistance 20K
T-gas pipe	-30~150	30~102	35~102	35~102	temperature sensor resistance 20K
T-economizer in	-30~150	no EVI under cooling	-20~55	-20~55	temperature sensor resistance 20K
T-economizer out	-30~150	no EVI under cooling	-20~55	-20~55	temperature sensor resistance 20K
T-remote room	-30~150	18~30	18~30	18~30	/
Dis. Pressure	-40~70	25~60	25~62	25~62	/
T-weather depend	-30~150	7~25	25~60	/	based on calculation

**1.5.5 Electric Data**

Model	Power Supply Leakage	Leakage Switch	Minimum Sectional Area of Earth Wire	Minimum Sectional Area of Power Supply Wire
	V,Ph,Hz	(A)	(mm <sup>2</sup> )	(mm <sup>2</sup> )
CH-HP4.0SIRK4(O)	230VAC, 1Ph, 50Hz	16	1.5	1.5
CH-HP6.0SIRK4(O)		16	1.5	1.5
CH-HP4.0SIRK4(I)		20	6.0	6.0
CH-HP6.0SIRK4(I)		20	6.0	6.0
CH-HP8.0SIRK4(O)	230VAC, 1Ph, 50Hz	25	4.0	4.0
CH-HP10SIRK4(O)		25	4.0	4.0
CH-HP8.0SIRK4(I)		40	6.0	6.0
CH-HP10SIRK4(I)		40	6.0	6.0

Model	Power Supply Leakage	Leakage Switch	Minimum Sectional Area of Earth Wire	Minimum Sectional Area of Power Supply Wire
	V,Ph,Hz	(A)	(mm <sup>2</sup> )	(mm <sup>2</sup> )
CH-HP8.0SIRM4(O)	400V,3N~,50Hz	16	2.5	2.5
CH-HP10SIRM4(O)		16	2.5	2.5
CH-HP8.0SIRM4(I)		20	4.0	4.0
CH-HP10SIRM4(I)		20	4.0	4.0
CH-HP12SIRM4(O)		16	2.5	2.5
CH-HP14SIRM4(O)		16	2.5	2.5
CH-HP16SIRM4(O)		16	2.5	2.5
CH-HP12SIRM4(I)		20	4.0	4.0
CH-HP14SIRM4(I)		20	4.0	4.0
CH-HP16SIRM4(I)		20	4.0	4.0
CH-HP12SIRK4(O)		230VAC,1Ph,50Hz	32	6.0
CH-HP14SIRK4(O)	40		6.0	6.0
CH-HP16SIRK4(O)	40		6.0	6.0
CH-HP12SIRK4(I)	40		6.0	6.0
CH-HP14SIRK4(I)	40		6.0	6.0
CH-HP16SIRK4(I)	40		6.0	6.0

**Notes**

- (a) Leakage switch is necessary for additional installation. If circuit breakers with leakage protection are in use, action response time must be less than 0.1 second, leakage circuit must be 30mA.
- (b) The above selected power cable diameters are determined based on assumption of distance from the distribution cabinet to the unit less than 75m. If cables are laid out in a distance of 75m to 150m, diameter of power cable must be increased to a further grade.
- (c) The power supply must be of rated voltage of the unit and special electrical line for air-conditioning.
- (d) All electrical installation shall be carried out by professional technicians in accordance with the local laws and regulations.
- (e) Ensure safe grounding and the grounding wire shall be connected with the special grounding equipment of the building and must be installed by professional technicians.
- (f) The specifications of the breaker and power cable listed in the table above are determined based on the maximum power (maximum amps) of the unit.
- (g) The specifications of the power cable listed in the table above are applied to the conduit-guarded multi-wire copper cable (like, YJV XLPE insulated power cable) used at 40°C and resistible to 90°C (see IEC 60364-5-52). If the working condition changes, they should be modified according to the related national standard.
- (h) The specifications of the breaker listed in the table above are applied to the breaker with the working temperature at 40°C. If the working condition changes, they should be modified according to the related national standard.
- (i) A circuit breaker must be added to the fixed line. The circuit breaker is all-pole disconnected and the breaking distance of the contact is at least 3mm.

1.5.6 Capacity Correction

◆ Cooling Capacity Correction

(1) 1-Phase Units

Cooling Capacity Correction_4									
Outflow Water (°C)	Ambient Temp.(°C)								
	10	15	20	25	30	35	40	45	48
7	2.58	2.87	3.02	3.21	3.28	3.15	2.87	2.24	1.89
8	2.65	2.93	3.09	3.28	3.34	3.21	2.93	2.27	1.92
9	2.68	2.99	3.15	3.34	3.40	3.28	2.99	2.33	1.95
10	2.74	3.02	3.21	3.40	3.47	3.34	3.02	2.36	1.98
11	2.77	3.09	3.28	3.47	3.53	3.40	3.09	2.39	2.05
12	2.84	3.15	3.34	3.53	3.56	3.47	3.15	2.46	2.08
13	2.87	3.21	3.37	3.56	3.65	3.50	3.21	2.49	2.11
14	2.93	3.24	3.43	3.62	3.72	3.56	3.24	2.52	2.14
15	2.96	3.31	3.47	3.69	3.78	3.62	3.31	2.58	2.17
18	3.12	3.50	3.65	3.91	3.97	3.81	3.50	2.71	2.27
20	3.21	3.56	3.78	4.03	4.10	3.94	3.56	2.80	2.36
23	3.37	3.72	3.94	4.19	4.28	4.13	3.72	2.93	2.46
25	3.47	3.84	4.06	4.32	4.41	4.22	3.84	2.99	2.52

Cooling Capacity Correction_6									
Outflow Water(°C)	Ambient Temp.(°C)								
	10	15	20	25	30	35	40	45	48
7	3.35	3.72	3.93	4.17	4.25	4.09	3.72	2.90	2.45
8	3.48	3.89	4.09	4.34	4.42	4.25	3.89	3.03	2.54
9	3.64	4.01	4.21	4.46	4.54	4.38	4.01	3.15	2.66
10	3.72	4.13	4.38	4.62	4.70	4.54	4.13	3.23	2.74
11	3.84	4.29	4.50	4.79	4.91	4.70	4.29	3.31	2.82
12	3.97	4.42	4.66	4.95	5.07	4.87	4.42	3.44	2.90
13	4.13	4.58	4.79	5.11	5.19	4.99	4.58	3.56	2.99
14	4.25	4.66	4.95	5.28	5.36	5.15	4.66	3.68	3.07
15	4.34	4.83	5.11	5.44	5.52	5.32	4.83	3.76	3.19
18	4.74	5.24	5.52	5.89	6.01	5.77	5.24	4.09	3.48
20	4.95	5.52	5.85	6.18	6.30	6.05	5.52	4.34	3.64
23	5.36	5.93	6.26	6.67	6.79	6.54	5.93	4.62	3.93
25	5.60	6.22	6.54	6.95	7.12	6.83	6.22	4.87	4.09

Cooling Capacity Correction_8									
Outflow Water(°C)	Ambient Temp.(°C)								
	10	15	20	25	30	35	40	45	48
7	4.35	4.82	5.09	5.41	5.51	5.30	4.82	3.76	3.18
8	4.51	4.98	5.25	5.57	5.67	5.46	4.98	3.87	3.29
9	4.56	5.09	5.35	5.72	5.83	5.62	5.09	3.98	3.34
10	4.72	5.25	5.51	5.88	5.99	5.78	5.25	4.08	3.45
11	4.88	5.41	5.72	6.04	6.20	5.94	5.41	4.19	3.55
12	4.98	5.57	5.88	6.25	6.31	6.10	5.57	4.35	3.66
13	5.09	5.67	5.99	6.31	6.41	6.20	5.67	4.40	3.71
14	5.25	5.83	6.10	6.47	6.63	6.36	5.83	4.51	3.82
15	5.35	5.99	6.25	6.68	6.78	6.52	5.99	4.66	3.92



Cooling Capacity Correction_8									
Outflow Water(°C)	Ambient Temp.(°C)								
	10	15	20	25	30	35	40	45	48
18	5.78	6.36	6.73	7.16	7.26	7.00	6.36	4.98	4.24
20	5.99	6.63	7.00	7.42	7.58	7.31	6.63	5.14	4.40
23	6.41	7.10	7.47	7.90	8.06	7.79	7.10	5.51	4.66
25	6.63	7.37	7.79	8.22	8.37	8.06	7.37	5.72	4.82

Cooling Capacity Correction_10									
Outflow Water(°C)	Ambient Temp.(°C)								
	10	15	20	25	30	35	40	45	48
7	5.33	5.92	6.24	6.63	6.76	6.50	5.92	4.62	3.90
8	5.46	6.11	6.44	6.83	6.96	6.70	6.11	4.75	4.03
9	5.66	6.24	6.57	7.02	7.15	6.89	6.24	4.94	4.10
10	5.79	6.37	6.70	7.22	7.35	7.02	6.37	5.01	4.23
11	5.92	6.57	6.96	7.35	7.54	7.22	6.57	5.07	4.36
12	6.11	6.70	7.15	7.54	7.67	7.41	6.70	5.27	4.49
13	6.24	6.89	7.35	7.74	7.87	7.61	6.89	5.40	4.55
14	6.44	7.15	7.48	7.93	8.13	7.80	7.15	5.53	4.68
15	6.57	7.28	7.67	8.19	8.32	8.00	7.28	5.72	4.81
18	7.02	7.74	8.13	8.65	8.91	8.52	7.74	6.05	5.14
20	7.35	8.13	8.58	9.10	9.30	8.91	8.13	6.31	5.33
23	7.74	8.58	9.04	9.62	9.82	9.43	8.58	6.63	5.66
25	8.00	8.91	9.36	10.01	10.21	9.82	8.91	6.96	5.98

Cooling Capacity Correction_12									
Outflow Water(°C)	Ambient Temp.(°C)								
	10	15	20	25	30	35	40	45	48
7	8.68	9.64	10.17	10.80	11.01	10.59	9.64	7.52	6.35
8	8.90	9.95	10.48	11.12	11.33	10.91	9.95	7.73	6.57
9	9.21	10.17	10.70	11.44	11.65	11.23	10.17	8.05	6.67
10	9.43	10.38	10.91	11.75	11.97	11.44	10.38	8.15	6.88
11	9.64	10.70	11.33	11.97	12.28	11.75	10.70	8.26	7.10
12	9.95	10.91	11.65	12.28	12.50	12.07	10.91	8.58	7.31
13	10.17	11.23	11.97	12.60	12.81	12.39	11.23	8.79	7.41
14	10.48	11.65	12.18	12.92	13.24	12.71	11.65	9.00	7.62
15	10.70	11.86	12.50	13.34	13.56	13.03	11.86	9.32	7.84
18	11.44	12.60	13.24	14.08	14.51	13.87	12.60	9.85	8.37
20	11.97	13.24	13.98	14.83	15.14	14.51	13.24	10.27	8.68
23	12.60	13.98	14.72	15.67	15.99	15.36	13.98	10.80	9.21
25	13.03	14.51	15.25	16.31	16.63	15.99	14.51	11.33	9.74

Cooling Capacity Correction_14									
Outflow Water(°C)	Ambient Temp.(°C)								
	10	15	20	25	30	35	40	45	48
7	7.90	8.76	9.25	9.82	10.02	11.07	8.76	6.84	5.78
8	8.09	9.05	9.53	10.11	10.31	11.21	9.05	7.03	5.97
9	8.38	9.25	9.73	10.40	10.59	11.35	9.25	7.32	6.07
10	8.57	9.44	9.92	10.69	10.88	11.49	9.44	7.42	6.26
11	8.76	9.73	10.31	10.88	11.17	11.63	9.73	7.51	6.45
12	9.05	9.92	10.59	11.17	11.36	11.77	9.92	7.80	6.65
13	9.25	10.21	10.88	11.46	11.65	11.90	10.21	7.99	6.74

Air-to-water Heat Pump Split Unitherm

Cooling Capacity Correction_14									
Outflow Water(°C)	Ambient Temp.(°C)								
	10	15	20	25	30	35	40	45	48
14	9.53	10.59	11.08	11.75	12.04	12.04	10.59	8.19	6.93
15	9.73	10.79	11.36	12.13	12.33	12.18	10.79	8.48	7.13
18	10.40	11.46	12.04	12.81	13.19	12.60	11.46	8.96	7.61
20	10.88	12.04	12.71	13.48	13.77	12.88	12.04	9.34	7.90
23	11.46	12.71	13.39	14.25	14.54	13.30	12.71	9.82	8.38
25	11.85	13.19	13.87	14.83	15.12	13.57	13.19	10.31	8.86

Cooling Capacity Correction_16									
Outflow Water(°C)	Ambient Temp.(°C)								
	10	15	20	25	30	35	40	45	48
7	8.13	9.02	9.52	10.11	10.31	11.51	9.02	7.04	5.95
8	8.33	9.32	9.81	10.41	10.61	11.65	9.32	7.24	6.15
9	8.62	9.52	10.01	10.71	10.90	11.78	9.52	7.53	6.25
10	8.82	9.72	10.21	11.00	11.20	11.92	9.72	7.63	6.44
11	9.02	10.01	10.61	11.20	11.50	12.05	10.01	7.73	6.64
12	9.32	10.21	10.90	11.50	11.70	12.19	10.21	8.03	6.84
13	9.52	10.51	11.20	11.80	12.00	12.32	10.51	8.23	6.94
14	9.81	10.90	11.40	12.09	12.39	12.46	10.90	8.43	7.14
15	10.01	11.10	11.70	12.49	12.69	12.59	11.10	8.72	7.34
18	10.71	11.80	12.39	13.19	13.58	13.00	11.80	9.22	7.83
20	11.20	12.39	13.09	13.88	14.18	13.27	12.39	9.62	8.13
23	11.80	13.09	13.78	14.67	14.97	13.68	13.09	10.11	8.62
25	12.19	13.58	14.28	15.27	15.56	13.95	13.58	10.61	9.12

(2) Three-phase units

Cooling Capacity Correction_8									
Outflow Water(°C)	Ambient Temp.(°C)								
	10	15	20	25	30	35	40	45	48
7	6.23	6.92	7.30	7.75	7.90	7.60	6.92	5.40	4.56
8	6.46	7.14	7.52	7.98	8.13	7.83	7.14	5.55	4.71
9	6.54	7.30	7.68	8.21	8.36	8.06	7.30	5.70	4.79
10	6.76	7.52	7.90	8.44	8.59	8.28	7.52	5.85	4.94
11	6.99	7.75	8.21	8.66	8.89	8.51	7.75	6.00	5.09
12	7.14	7.98	8.44	8.97	9.04	8.74	7.98	6.23	5.24
13	7.30	8.13	8.59	9.04	9.20	8.89	8.13	6.31	5.32
14	7.52	8.36	8.74	9.27	9.50	9.12	8.36	6.46	5.47
15	7.68	8.59	8.97	9.58	9.73	9.35	8.59	6.69	5.62
18	8.28	9.12	9.65	10.26	10.41	10.03	9.12	7.14	6.08
20	8.59	9.50	10.03	10.64	10.87	10.49	9.50	7.37	6.31
23	9.20	10.18	10.72	11.32	11.55	11.17	10.18	7.90	6.69
25	9.50	10.56	11.17	11.78	12.01	11.55	10.56	8.21	6.92

Cooling Capacity Correction_10									
Outflow Water(°C)	Ambient Temp.(°C)								
	10	15	20	25	30	35	40	45	48
7	6.72	7.46	7.87	8.36	8.53	8.20	7.46	5.82	4.92
8	6.89	7.71	8.12	8.61	8.77	8.45	7.71	5.99	5.08
9	7.13	7.87	8.28	8.86	9.02	8.69	7.87	6.23	5.17
10	7.30	8.04	8.45	9.10	9.27	8.86	8.04	6.31	5.33

Cooling Capacity Correction_10									
Outflow Water(°C)	Ambient Temp.(°C)								
	10	15	20	25	30	35	40	45	48
11	7.46	8.28	8.77	9.27	9.51	9.10	8.28	6.40	5.49
12	7.71	8.45	9.02	9.51	9.68	9.35	8.45	6.64	5.66
13	7.87	8.69	9.27	9.76	9.92	9.59	8.69	6.81	5.74
14	8.12	9.02	9.43	10.00	10.25	9.84	9.02	6.97	5.90
15	8.28	9.18	9.68	10.33	10.50	10.09	9.18	7.22	6.07
18	8.86	9.76	10.25	10.91	11.23	10.74	9.76	7.63	6.48
20	9.27	10.25	10.82	11.48	11.73	11.23	10.25	7.95	6.72
23	9.76	10.82	11.40	12.14	12.38	11.89	10.82	8.36	7.13
25	10.09	11.23	11.81	12.63	12.87	12.38	11.23	8.77	7.54

Cooling Capacity Correction_12									
Outflow Water(°C)	Ambient Temp.(°C)								
	10	15	20	25	30	35	40	45	48
7	8.73	9.69	10.22	10.86	11.08	10.65	9.69	7.56	6.39
8	8.95	10.01	10.54	11.18	11.40	10.97	10.01	7.77	6.60
9	9.27	10.22	10.76	11.50	11.72	11.29	10.22	8.09	6.71
10	9.48	10.44	10.97	11.82	12.03	11.50	10.44	8.20	6.92
11	9.69	10.76	11.40	12.03	12.35	11.82	10.76	8.31	7.14
12	10.01	10.97	11.72	12.35	12.57	12.14	10.97	8.63	7.35
13	10.22	11.29	12.03	12.67	12.89	12.46	11.29	8.84	7.46
14	10.54	11.72	12.25	12.99	13.31	12.78	11.72	9.05	7.67
15	10.76	11.93	12.57	13.42	13.63	13.10	11.93	9.37	7.88
18	11.50	12.67	13.31	14.16	14.59	13.95	12.67	9.90	8.41
20	12.03	13.31	14.06	14.91	15.23	14.59	13.31	10.33	8.73
23	12.67	14.06	14.80	15.76	16.08	15.44	14.06	10.86	9.27
25	13.10	14.59	15.34	16.40	16.72	16.08	14.59	11.40	9.80

Cooling Capacity Correction_14									
Outflow Water(°C)	Ambient Temp.(°C)								
	10	15	20	25	30	35	40	45	48
7	8.02	8.90	9.39	9.97	10.17	11.24	8.90	6.94	5.87
8	8.21	9.19	9.68	10.27	10.46	11.38	9.19	7.14	6.06
9	8.51	9.39	9.88	10.56	10.76	11.52	9.39	7.43	6.16
10	8.70	9.58	10.07	10.85	11.05	11.66	9.58	7.53	6.36
11	8.90	9.88	10.46	11.05	11.34	11.80	9.88	7.63	6.55
12	9.19	10.07	10.76	11.34	11.54	11.95	10.07	7.92	6.75
13	9.39	10.37	11.05	11.64	11.83	12.09	10.37	8.12	6.85
14	9.68	10.76	11.25	11.93	12.22	12.23	10.76	8.31	7.04
15	9.88	10.95	11.54	12.32	12.52	12.37	10.95	8.61	7.24
18	10.56	11.64	12.22	13.01	13.40	12.79	11.64	9.09	7.73
20	11.05	12.22	12.91	13.69	13.98	13.08	12.22	9.49	8.02
23	11.64	12.91	13.59	14.47	14.77	13.50	12.91	9.97	8.51
25	12.03	13.40	14.08	15.06	15.35	13.78	13.40	10.46	9.00

Air-to-water Heat Pump Split Unitherm

Cooling Capacity Correction_16									
Outflow Water(°C)	Ambient Temp.(°C)								
	10	15	20	25	30	35	40	45	48
7	8.14	9.03	9.53	10.12	10.32	11.52	9.03	7.04	5.95
8	8.33	9.33	9.82	10.42	10.62	11.66	9.33	7.24	6.15
9	8.63	9.53	10.02	10.72	10.91	11.79	9.53	7.54	6.25
10	8.83	9.72	10.22	11.01	11.21	11.93	9.72	7.64	6.45
11	9.03	10.02	10.62	11.21	11.51	12.06	10.02	7.74	6.65
12	9.33	10.22	10.91	11.51	11.71	12.20	10.22	8.04	6.85
13	9.53	10.52	11.21	11.81	12.01	12.33	10.52	8.24	6.95
14	9.82	10.91	11.41	12.11	12.40	12.47	10.91	8.43	7.14
15	10.02	11.11	11.71	12.50	12.70	12.60	11.11	8.73	7.34
18	10.72	11.81	12.40	13.20	13.59	13.01	11.81	9.23	7.84
20	11.21	12.40	13.10	13.89	14.19	13.28	12.40	9.62	8.14
23	11.81	13.10	13.79	14.68	14.98	13.69	13.10	10.12	8.63
25	12.20	13.59	14.29	15.28	15.58	13.96	13.59	10.62	9.13

◆ EER Correction

(1) 1-Phase units

EER Correction_4									
Outflow Water (°C)	Ambient Temp.(°C)								
	10	15	20	25	30	35	40	45	48
7	4.62	4.45	4.32	4.11	3.77	3.40	2.82	2.07	1.67
8	4.76	4.59	4.45	4.25	3.88	3.50	2.89	2.14	1.73
9	4.93	4.73	4.59	4.39	4.01	3.60	3.03	2.21	1.77
10	5.07	4.86	4.73	4.49	4.11	3.74	3.09	2.28	1.80
11	5.20	5.03	4.86	4.62	4.25	3.84	3.16	2.35	1.87
12	5.37	5.17	5.00	4.76	4.39	3.94	3.26	2.41	1.90
13	5.51	5.30	5.13	4.90	4.52	4.05	3.37	2.48	1.97
14	5.68	5.44	5.27	5.03	4.62	4.15	3.43	2.52	2.04
15	5.78	5.61	5.41	5.17	4.73	4.25	3.54	2.62	2.07
18	6.22	6.02	5.81	5.58	5.10	4.59	3.81	2.82	2.28
20	6.53	6.32	6.12	5.85	5.34	4.79	4.01	2.96	2.38
23	6.97	6.73	6.49	6.22	5.71	5.13	4.28	3.13	2.52
25	7.28	7.00	6.80	6.46	5.95	5.34	4.42	3.26	2.62

EER Correction_6									
Outflow Water (°C)	Ambient Temp.(°C)								
	10	15	20	25	30	35	40	45	48
7	4.35	4.19	4.06	3.87	3.55	3.20	2.66	1.95	1.57
8	4.48	4.32	4.19	4.00	3.65	3.30	2.75	2.02	1.63
9	4.67	4.48	4.35	4.13	3.81	3.42	2.85	2.08	1.66
10	4.80	4.61	4.48	4.26	3.90	3.52	2.91	2.18	1.73
11	4.93	4.77	4.61	4.42	4.06	3.65	3.01	2.21	1.76
12	5.09	4.93	4.77	4.54	4.16	3.74	3.10	2.30	1.86
13	5.25	5.06	4.90	4.67	4.29	3.87	3.20	2.34	1.89
14	5.41	5.22	5.06	4.80	4.42	3.97	3.30	2.43	1.95
15	5.54	5.34	5.18	4.93	4.51	4.10	3.39	2.50	1.98
18	5.98	5.76	5.60	5.34	4.90	4.42	3.65	2.69	2.18
20	6.30	6.08	5.89	5.60	5.15	4.64	3.84	2.85	2.27
23	6.75	6.50	6.34	6.02	5.50	4.96	4.13	3.01	2.43
25	7.04	6.78	6.59	6.30	5.76	5.18	4.32	3.17	2.56

EER Correction_8									
Outflow Water (°C)	Ambient Temp.(°C)								
	10	15	20	25	30	35	40	45	48
7	4.22	4.06	3.94	3.75	3.44	3.10	2.57	1.89	1.52
8	4.31	4.15	4.06	3.84	3.53	3.19	2.64	1.92	1.55
9	4.46	4.28	4.15	3.97	3.63	3.29	2.73	1.98	1.58
10	4.56	4.40	4.28	4.06	3.72	3.35	2.79	2.02	1.64
11	4.68	4.53	4.40	4.19	3.84	3.44	2.88	2.11	1.71
12	4.81	4.62	4.50	4.25	3.94	3.53	2.95	2.17	1.74
13	4.93	4.77	4.62	4.40	4.03	3.63	3.04	2.20	1.77
14	5.05	4.87	4.71	4.50	4.12	3.72	3.10	2.26	1.80
15	5.21	4.99	4.84	4.59	4.22	3.81	3.16	2.33	1.86
18	5.52	5.33	5.18	4.90	4.50	4.06	3.35	2.48	1.98
20	5.77	5.55	5.39	5.15	4.71	4.25	3.50	2.57	2.08
23	6.11	5.86	5.70	5.46	4.99	4.50	3.72	2.76	2.20
25	6.36	6.14	5.92	5.64	5.18	4.68	3.88	2.85	2.29

EER Correction_10									
Outflow Water (°C)	Ambient Temp.(°C)								
	10	15	20	25	30	35	40	45	48
7	3.94	3.80	3.68	3.51	3.22	2.90	2.41	1.77	1.42
8	4.06	3.92	3.80	3.63	3.31	2.99	2.47	1.80	1.48
9	4.21	4.06	3.92	3.74	3.42	3.07	2.55	1.89	1.54
10	4.29	4.15	4.00	3.86	3.51	3.16	2.61	1.94	1.54
11	4.41	4.26	4.12	3.92	3.63	3.25	2.70	1.97	1.60
12	4.52	4.35	4.23	4.03	3.71	3.34	2.76	2.03	1.62
13	4.67	4.50	4.35	4.15	3.83	3.42	2.87	2.12	1.68
14	4.76	4.58	4.47	4.26	3.89	3.51	2.93	2.15	1.74
15	4.90	4.70	4.55	4.35	3.97	3.60	2.99	2.18	1.77
18	5.25	5.08	4.90	4.67	4.29	3.86	3.19	2.35	1.89
20	5.51	5.28	5.16	4.90	4.50	4.03	3.36	2.47	2.00
23	5.83	5.60	5.45	5.19	4.76	4.29	3.54	2.61	2.09
25	6.06	5.86	5.66	5.39	4.96	4.47	3.71	2.73	2.20

EER Correction_12									
Outflow Water(°C)	Ambient Temp.(°C)								
	10	15	20	25	30	35	40	45	48
7	4.50	4.34	4.21	4.01	3.68	2.79	2.75	2.02	1.62
8	4.64	4.47	4.34	4.14	3.78	2.94	2.81	2.05	1.69
9	4.80	4.64	4.47	4.27	3.91	3.08	2.91	2.15	1.76
10	4.90	4.74	4.57	4.40	4.01	3.23	2.98	2.22	1.76
11	5.03	4.87	4.70	4.47	4.14	3.38	3.08	2.25	1.82
12	5.17	4.97	4.84	4.60	4.24	3.52	3.15	2.32	1.85
13	5.33	5.13	4.97	4.74	4.37	3.67	3.28	2.42	1.92
14	5.43	5.23	5.10	4.87	4.44	3.81	3.34	2.45	1.99
15	5.60	5.37	5.20	4.97	4.54	3.96	3.41	2.48	2.02
18	5.99	5.80	5.60	5.33	4.90	4.40	3.64	2.68	2.15
20	6.29	6.03	5.89	5.60	5.13	4.69	3.84	2.81	2.29
23	6.66	6.39	6.23	5.93	5.43	5.13	4.04	2.98	2.38
25	6.92	6.69	6.46	6.16	5.66	5.42	4.24	3.11	2.52

Air-to-water Heat Pump Split Unitherm

EER Correction_14									
Outflow Water (°C)	Ambient Temp.(°C)								
	10	15	20	25	30	35	40	45	48
7	3.79	3.65	3.54	3.37	3.09	2.65	2.31	1.70	1.37
8	3.90	3.76	3.65	3.48	3.18	2.75	2.37	1.73	1.42
9	4.04	3.90	3.76	3.60	3.29	2.85	2.45	1.81	1.48
10	4.12	3.99	3.85	3.71	3.37	2.94	2.51	1.87	1.48
11	4.24	4.10	3.96	3.76	3.48	3.04	2.59	1.90	1.53
12	4.35	4.18	4.07	3.87	3.57	3.13	2.65	1.95	1.56
13	4.49	4.32	4.18	3.99	3.68	3.23	2.76	2.03	1.62
14	4.57	4.40	4.29	4.10	3.73	3.32	2.81	2.06	1.67
15	4.71	4.51	4.38	4.18	3.82	3.42	2.87	2.09	1.70
18	5.04	4.88	4.71	4.49	4.12	3.70	3.07	2.26	1.81
20	5.30	5.07	4.96	4.71	4.32	3.89	3.23	2.37	1.92
23	5.60	5.38	5.24	4.99	4.57	4.18	3.40	2.51	2.01
25	5.82	5.63	5.43	5.18	4.77	4.37	3.57	2.62	2.12

EER Correction_16									
Outflow Water (°C)	Ambient Temp.(°C)								
	10	15	20	25	30	35	40	45	48
7	3.68	3.54	3.43	3.27	3.00	2.57	2.24	1.65	1.32
8	3.78	3.65	3.54	3.38	3.08	2.67	2.30	1.68	1.38
9	3.92	3.78	3.65	3.49	3.19	2.76	2.38	1.76	1.43
10	4.00	3.87	3.73	3.59	3.27	2.85	2.43	1.81	1.43
11	4.11	3.97	3.84	3.65	3.38	2.94	2.51	1.84	1.49
12	4.22	4.05	3.95	3.76	3.46	3.04	2.57	1.89	1.51
13	4.35	4.19	4.05	3.87	3.57	3.13	2.68	1.97	1.57
14	4.43	4.27	4.16	3.97	3.62	3.22	2.73	2.00	1.62
15	4.57	4.38	4.24	4.05	3.70	3.31	2.78	2.03	1.65
18	4.89	4.73	4.57	4.35	4.00	3.59	2.97	2.19	1.76
20	5.14	4.92	4.81	4.57	4.19	3.77	3.14	2.30	1.86
23	5.43	5.22	5.08	4.84	4.43	4.05	3.30	2.43	1.95
25	5.65	5.46	5.27	5.03	4.62	4.23	3.46	2.54	2.05

(2) 3-Phase units

EER Correction_8									
Outflow Water(°C)	Ambient Temp.(°C)								
	10	15	20	25	30	35	40	45	48
7	6.80	6.55	6.35	6.05	5.55	5.00	4.15	3.05	2.45
8	6.95	6.70	6.55	6.20	5.70	5.15	4.25	3.10	2.50
9	7.20	6.90	6.70	6.40	5.85	5.30	4.40	3.20	2.55
10	7.35	7.10	6.90	6.55	6.00	5.40	4.50	3.25	2.65
11	7.55	7.30	7.10	6.75	6.20	5.55	4.65	3.40	2.75
12	7.75	7.45	7.25	6.85	6.35	5.70	4.75	3.50	2.80
13	7.95	7.70	7.45	7.10	6.50	5.85	4.90	3.55	2.85
14	8.15	7.85	7.60	7.25	6.65	6.00	5.00	3.65	2.90
15	8.40	8.05	7.80	7.40	6.80	6.15	5.10	3.75	3.00
18	8.90	8.60	8.35	7.90	7.25	6.55	5.40	4.00	3.20
20	9.30	8.95	8.70	8.30	7.60	6.85	5.65	4.15	3.35
23	9.85	9.45	9.20	8.80	8.05	7.25	6.00	4.45	3.55
25	10.25	9.90	9.55	9.10	8.35	7.55	6.25	4.60	3.70

EER Correction_10									
Outflow Water (°C)	Ambient Temp.(°C)								
	10	15	20	25	30	35	40	45	48
7	5.85	5.63	5.46	5.20	4.77	4.30	3.57	2.62	2.11
8	6.02	5.81	5.63	5.38	4.90	4.43	3.66	2.67	2.19
9	6.24	6.02	5.81	5.55	5.07	4.56	3.78	2.80	2.28
10	6.36	6.15	5.93	5.72	5.20	4.69	3.87	2.88	2.28
11	6.54	6.32	6.11	5.81	5.38	4.82	4.00	2.92	2.37
12	6.71	6.45	6.28	5.98	5.50	4.95	4.09	3.01	2.41
13	6.92	6.67	6.45	6.15	5.68	5.07	4.26	3.14	2.49
14	7.05	6.79	6.62	6.32	5.76	5.20	4.34	3.18	2.58
15	7.27	6.97	6.75	6.45	5.89	5.33	4.43	3.23	2.62
18	7.78	7.53	7.27	6.92	6.36	5.72	4.73	3.48	2.80
20	8.17	7.83	7.65	7.27	6.67	5.98	4.99	3.66	2.97
23	8.64	8.30	8.08	7.70	7.05	6.36	5.25	3.87	3.10
25	8.99	8.69	8.39	8.00	7.35	6.62	5.50	4.04	3.27

EER Correction_12									
Outflow Water(°C)	Ambient Temp.(°C)								
	10	15	20	25	30	35	40	45	48
7	4.60	4.43	4.30	4.09	3.76	2.85	2.81	2.06	1.66
8	4.74	4.57	4.43	4.23	3.86	3.00	2.88	2.10	1.73
9	4.91	4.74	4.57	4.36	3.99	3.15	2.98	2.20	1.79
10	5.01	4.84	4.67	4.50	4.09	3.30	3.04	2.27	1.79
11	5.14	4.97	4.80	4.57	4.23	3.45	3.15	2.30	1.86
12	5.28	5.07	4.94	4.70	4.33	3.60	3.21	2.37	1.89
13	5.45	5.24	5.07	4.84	4.47	3.75	3.35	2.47	1.96
14	5.55	5.35	5.21	4.97	4.53	3.90	3.42	2.50	2.03
15	5.72	5.48	5.31	5.07	4.63	4.05	3.48	2.54	2.06
18	6.12	5.92	5.72	5.45	5.01	4.49	3.72	2.74	2.20
20	6.43	6.16	6.02	5.72	5.24	4.79	3.92	2.88	2.33
23	6.80	6.53	6.36	6.06	5.55	5.24	4.13	3.04	2.44
25	7.07	6.83	6.60	6.29	5.78	5.54	4.33	3.18	2.57

EER Correction_14									
Outflow Water(°C)	Ambient Temp.(°C)								
	10	15	20	25	30	35	40	45	48
7	3.89	3.75	3.63	3.46	3.18	2.72	2.37	1.74	1.40
8	4.00	3.86	3.75	3.58	3.26	2.82	2.43	1.77	1.46
9	4.15	4.00	3.86	3.69	3.38	2.92	2.52	1.86	1.52
10	4.23	4.09	3.95	3.80	3.46	3.02	2.57	1.92	1.52
11	4.35	4.21	4.06	3.86	3.58	3.12	2.66	1.95	1.57
12	4.46	4.29	4.18	3.98	3.66	3.21	2.72	2.00	1.60
13	4.61	4.43	4.29	4.09	3.78	3.31	2.83	2.09	1.66
14	4.69	4.52	4.41	4.21	3.83	3.41	2.89	2.12	1.72
15	4.83	4.63	4.49	4.29	3.92	3.51	2.95	2.15	1.74
18	5.18	5.01	4.83	4.61	4.23	3.80	3.15	2.32	1.86
20	5.44	5.21	5.09	4.83	4.43	3.99	3.32	2.43	1.97
23	5.75	5.52	5.38	5.12	4.69	4.29	3.49	2.57	2.06
25	5.98	5.78	5.58	5.32	4.89	4.48	3.66	2.69	2.17

Air-to-water Heat Pump Split Unitherm

EER Correction_16									
Outflow Water(°C)	Ambient Temp.(°C)								
	10	15	20	25	30	35	40	45	48
7	3.76	3.62	3.51	3.35	3.07	2.63	2.30	1.69	1.36
8	3.87	3.73	3.62	3.46	3.15	2.73	2.35	1.71	1.41
9	4.01	3.87	3.73	3.57	3.26	2.82	2.43	1.80	1.47
10	4.09	3.96	3.82	3.68	3.35	2.92	2.49	1.85	1.47
11	4.20	4.07	3.93	3.73	3.46	3.01	2.57	1.88	1.52
12	4.31	4.15	4.04	3.84	3.54	3.11	2.63	1.94	1.55
13	4.45	4.29	4.15	3.96	3.65	3.20	2.74	2.02	1.60
14	4.54	4.37	4.26	4.07	3.71	3.29	2.79	2.05	1.66
15	4.67	4.48	4.34	4.15	3.79	3.39	2.85	2.07	1.69
18	5.01	4.84	4.67	4.45	4.09	3.67	3.04	2.24	1.80
20	5.26	5.03	4.92	4.67	4.29	3.86	3.21	2.35	1.91
23	5.56	5.34	5.20	4.95	4.54	4.14	3.37	2.49	1.99
25	5.78	5.59	5.39	5.14	4.73	4.33	3.54	2.60	2.10

◆ Heating Capacity Correction

(1) 1-Phase units

Heating Capacity Correction_4														
Outflow heated Water(°C)	Ambient Temp.(°C)													
	-25	-20	-15	-10	-7	-2	2	7	10	15	20	25	30	35
25	1.72	2.08	2.48	2.84	3.04	3.40	3.76	3.68	3.80	4.00	3.96	3.60	3.16	2.48
30	1.68	2.04	2.40	2.76	2.96	3.28	3.64	3.88	4.00	4.24	4.20	3.80	3.32	2.60
35	1.64	1.92	2.24	2.60	2.80	3.12	3.40	4.00	4.12	4.36	4.32	3.92	3.44	2.68
40	1.64	1.92	2.24	2.60	2.80	3.12	3.40	4.00	4.12	4.36	4.32	3.92	3.44	2.68
45	\	1.92	2.24	2.60	2.80	3.12	3.40	4.00	4.12	4.36	4.32	3.92	3.44	2.68
50	\	\	2.16	2.52	2.72	3.04	3.28	3.88	4.00	4.24	4.20	3.80	3.32	2.60
55	\	\	\	2.40	2.56	2.88	3.12	3.68	3.80	4.00	3.96	3.60	3.16	2.48
60	\	\	\	\	2.44	2.72	2.96	3.48	3.60	3.80	3.76	3.40	3.00	2.32

Heating Capacity Correction_6														
Outflow heated Water(°C)	Ambient Temp.(°C)													
	-25	-20	-15	-10	-7	-2	2	7	10	15	20	25	30	35
25	2.89	3.48	4.13	4.72	5.07	5.66	6.25	6.14	6.31	6.67	6.61	6.02	5.25	4.13
30	2.66	3.19	3.78	4.31	4.66	5.13	5.72	6.08	6.25	6.61	6.55	5.96	5.25	4.07
35	2.48	2.89	3.36	3.89	4.19	4.72	5.13	6.02	6.20	6.55	6.49	5.90	5.19	4.01
40	2.42	2.83	3.36	3.89	4.19	4.66	5.07	5.96	6.14	6.49	6.43	5.84	5.13	4.01
45	\	2.83	3.30	3.84	4.13	4.60	5.02	5.90	6.08	6.43	6.37	5.78	5.07	3.95
50	\	\	3.25	3.78	4.07	4.54	4.96	5.84	6.02	6.37	6.31	5.72	5.02	3.89
55	\	\	\	3.78	4.07	4.48	4.90	5.78	5.96	6.31	6.25	5.66	4.96	3.89
60	\	\	\	\	4.01	4.48	4.84	5.72	5.90	6.25	6.20	5.61	4.90	3.84



Heating Capacity Correction_8														
Outflow heated Water(°C)	Ambient Temp.(°C)													
	-25	-20	-15	-10	-7	-2	2	7	10	15	20	25	30	35
25	3.44	4.16	4.96	5.68	6.08	6.80	7.52	7.36	7.60	8.00	7.92	7.20	6.32	4.96
30	3.36	4.08	4.80	5.52	5.92	6.56	7.28	7.76	8.00	8.48	8.40	7.60	6.64	5.20
35	3.28	3.84	4.48	5.20	5.60	6.24	6.80	8.00	8.24	8.72	8.64	7.84	6.88	5.36
40	3.28	3.84	4.48	5.20	5.60	6.24	6.80	8.00	8.24	8.72	8.64	7.84	6.88	5.36
45	\	3.84	4.48	5.20	5.60	6.24	6.80	8.00	8.24	8.72	8.64	7.84	6.88	5.36
50	\	\	4.32	5.04	5.44	6.08	6.56	7.76	8.00	8.48	8.40	7.60	6.64	5.20
55	\	\	\	4.80	5.12	5.76	6.24	7.36	7.60	8.00	7.92	7.20	6.32	4.96
60	\	\	\	\	4.88	5.44	5.92	6.96	7.20	7.60	7.52	6.80	6.00	4.64

Heating Capacity Correction_10														
Outflow heated Water(°C)	Ambient Temp.(°C)													
	-25	-20	-15	-10	-7	-2	2	7	10	15	20	25	30	35
25	4.09	4.94	5.89	6.75	7.22	8.08	8.93	8.74	9.03	9.50	9.41	8.55	7.51	5.89
30	3.99	4.85	5.70	6.56	7.03	7.79	8.65	9.22	9.50	10.07	9.98	9.03	7.89	6.18
35	3.90	4.56	5.32	6.18	6.65	7.41	8.08	9.50	9.79	10.36	10.26	9.31	8.17	6.37
40	3.90	4.56	5.32	6.18	6.65	7.41	8.08	9.50	9.79	10.36	10.26	9.31	8.17	6.37
45	\	4.56	5.32	6.18	6.65	7.41	8.08	9.50	9.79	10.36	10.26	9.31	8.17	6.37
50	\	\	5.13	5.99	6.46	7.22	7.79	9.22	9.50	10.07	9.98	9.03	7.89	6.18
55	\	\	\	5.70	6.08	6.84	7.41	8.74	9.03	9.50	9.41	8.55	7.51	5.89
60	\	\	\	\	5.80	6.46	7.03	8.27	8.55	9.03	8.93	8.08	7.13	5.51

Heating Capacity Correction_12														
Outflow heated Water(°C)	Ambient Temp.(°C)													
	-25	-20	-15	-10	-7	-2	2	7	10	15	20	25	30	35
25	5.17	6.25	7.46	8.54	9.14	10.22	11.31	11.60	11.43	12.03	11.91	10.83	9.50	7.46
30	5.05	6.13	7.22	8.30	8.90	9.86	10.95	11.80	12.03	12.75	12.63	11.43	9.98	7.82
35	4.93	5.77	6.74	7.82	8.42	9.38	10.22	12.00	12.39	13.11	12.99	11.79	10.34	8.06
40	4.93	5.77	6.74	7.82	8.42	9.38	10.22	12.20	12.39	13.11	12.99	11.79	10.34	8.06
45	\	5.77	6.74	7.82	8.42	9.38	10.22	12.40	12.39	13.11	12.99	11.79	10.34	8.06
50	\	\	6.50	7.58	8.18	9.14	9.86	12.60	12.03	12.75	12.63	11.43	9.98	7.82
55	\	\	\	7.22	7.70	8.66	9.38	12.80	11.43	12.03	11.91	10.83	9.50	7.46
60	\	\	\	\	7.34	8.18	8.90	13.00	10.83	11.43	11.31	10.22	9.02	6.98

Heating Capacity Correction_14														
Outflow heated Water(°C)	Ambient Temp.(°C)													
	-25	-20	-15	-10	-7	-2	2	7	10	15	20	25	30	35
25	6.04	7.30	8.71	9.97	10.67	11.94	13.20	13.52	13.34	14.05	13.91	12.64	11.10	8.71
30	5.90	7.16	8.43	9.69	10.39	11.52	12.78	13.76	14.05	14.89	14.75	13.34	11.66	9.13
35	5.76	6.74	7.87	9.13	9.83	10.96	11.94	14.00	14.47	15.31	15.17	13.76	12.08	9.41
40	5.76	6.74	7.87	9.13	9.83	10.96	11.94	14.24	14.47	15.31	15.17	13.76	12.08	9.41
45	\	6.74	7.87	9.13	9.83	10.96	11.94	14.48	14.47	15.31	15.17	13.76	12.08	9.41
50	\	\	7.58	8.85	9.55	10.67	11.52	14.72	14.05	14.89	14.75	13.34	11.66	9.13
55	\	\	\	8.43	8.99	10.11	10.96	14.96	13.34	14.05	13.91	12.64	11.10	8.71
60	\	\	\	\	8.57	9.55	10.39	15.20	12.64	13.34	13.20	11.94	10.53	8.15

Air-to-water Heat Pump Split Unitherm

Heating Capacity Correction_16														
Outflow heated Water(°C)	Ambient Temp.(°C)													
	-25	-20	-15	-10	-7	-2	2	7	10	15	20	25	30	35
25	6.64	8.03	9.58	10.97	11.74	13.13	14.52	14.91	14.67	15.45	15.29	13.90	12.20	9.58
30	6.49	7.88	9.27	10.66	11.43	12.67	14.06	15.21	15.45	16.37	16.22	14.67	12.82	10.04
35	6.33	7.41	8.65	10.04	10.81	12.05	13.13	15.50	15.91	16.84	16.68	15.14	13.28	10.35
40	6.33	7.41	8.65	10.04	10.81	12.05	13.13	15.80	15.91	16.84	16.68	15.14	13.28	10.35
45	\	7.41	8.65	10.04	10.81	12.05	13.13	16.09	15.91	16.84	16.68	15.14	13.28	10.35
50	\	\	8.34	9.73	10.50	11.74	12.67	16.39	15.45	16.37	16.22	14.67	12.82	10.04
55	\	\	\	9.27	9.89	11.12	12.05	16.68	14.67	15.45	15.29	13.90	12.20	9.58
60	\	\	\	\	9.42	10.50	11.43	16.98	13.90	14.67	14.52	13.13	11.58	8.96

(2) 3-Phase units

Heating Capacity Correction_8														
Outflow heated Water(°C)	Ambient Temp.(°C)													
	-25	-20	-15	-10	-7	-2	2	7	10	15	20	25	30	35
25	3.44	4.16	4.96	5.68	6.08	6.80	7.52	7.36	7.60	8.00	7.92	7.20	6.32	4.96
30	3.36	4.08	4.80	5.52	5.92	6.56	7.28	7.76	8.00	8.48	8.40	7.60	6.64	5.20
35	3.28	3.84	4.48	5.20	5.60	6.24	6.80	8.00	8.24	8.72	8.64	7.84	6.88	5.36
40	3.28	3.84	4.48	5.20	5.60	6.24	6.80	8.00	8.24	8.72	8.64	7.84	6.88	5.36
45	\	3.84	4.48	5.20	5.60	6.24	6.80	8.00	8.24	8.72	8.64	7.84	6.88	5.36
50	\	\	4.32	5.04	5.44	6.08	6.56	7.76	8.00	8.48	8.40	7.60	6.64	5.20
55	\	\	\	4.80	5.12	5.76	6.24	7.36	7.60	8.00	7.92	7.20	6.32	4.96
60	\	\	\	\	4.88	5.44	5.92	6.96	7.20	7.60	7.52	6.80	6.00	4.64

Heating Capacity Correction_10														
Outflow heated Water(°C)	Ambient Temp.(°C)													
	-25	-20	-15	-10	-7	-2	2	7	10	15	20	25	30	35
25	4.39	5.30	6.32	7.24	7.75	8.67	9.59	9.38	9.69	10.20	10.10	9.18	8.06	6.32
30	4.28	5.20	6.12	7.04	7.55	8.36	9.28	9.89	10.20	10.81	10.71	9.69	8.47	6.63
35	4.18	4.90	5.71	6.63	7.14	7.96	8.67	10.20	10.51	11.12	11.02	10.00	8.77	6.83
40	4.18	4.90	5.71	6.63	7.14	7.96	8.67	10.20	10.51	11.12	11.02	10.00	8.77	6.83
45	\	4.90	5.71	6.63	7.14	7.96	8.67	10.20	10.51	11.12	11.02	10.00	8.77	6.83
50	\	\	5.51	6.43	6.94	7.75	8.36	9.89	10.20	10.81	10.71	9.69	8.47	6.63
55	\	\	\	6.12	6.53	7.34	7.96	9.38	9.69	10.20	10.10	9.18	8.06	6.32
60	\	\	\	\	6.22	6.94	7.55	8.87	9.18	9.69	9.59	8.67	7.65	5.92

Heating Capacity Correction_12														
Outflow heated Water(°C)	Ambient Temp.(°C)													
	-25	-20	-15	-10	-7	-2	2	7	10	15	20	25	30	35
25	5.13	6.20	7.39	8.46	9.06	10.13	11.21	11.50	11.33	11.92	11.80	10.73	9.42	7.39
30	5.01	6.08	7.15	8.23	8.82	9.78	10.85	11.70	11.92	12.64	12.52	11.33	9.89	7.75
35	4.89	5.72	6.68	7.75	8.34	9.30	10.13	11.89	12.28	12.99	12.88	11.68	10.25	7.99
40	4.89	5.72	6.68	7.75	8.34	9.30	10.13	12.09	12.28	12.99	12.88	11.68	10.25	7.99
45	\	5.72	6.68	7.75	8.34	9.30	10.13	12.29	12.28	12.99	12.88	11.68	10.25	7.99
50	\	\	6.44	7.51	8.11	9.06	9.78	12.49	11.92	12.64	12.52	11.33	9.89	7.75
55	\	\	\	7.15	7.63	8.58	9.30	12.69	11.33	11.92	11.80	10.73	9.42	7.39
60	\	\	\	\	7.27	8.11	8.82	12.88	10.73	11.33	11.21	10.13	8.94	6.91

Heating Capacity Correction_14														
Outflow heated Water(°C)	Ambient Temp.(°C)													
	-25	-20	-15	-10	-7	-2	2	7	10	15	20	25	30	35
25	6.02	7.28	8.68	9.94	10.65	11.91	13.17	13.48	13.31	14.01	13.87	12.61	11.07	8.68
30	5.88	7.14	8.40	9.66	10.37	11.49	12.75	13.72	14.01	14.85	14.71	13.31	11.63	9.10
35	5.74	6.72	7.84	9.10	9.80	10.93	11.91	13.96	14.43	15.27	15.13	13.73	12.05	9.38
40	5.74	6.72	7.84	9.10	9.80	10.93	11.91	14.20	14.43	15.27	15.13	13.73	12.05	9.38
45	\	6.72	7.84	9.10	9.80	10.93	11.91	14.44	14.43	15.27	15.13	13.73	12.05	9.38
50	\	\	7.56	8.82	9.52	10.65	11.49	14.68	14.01	14.85	14.71	13.31	11.63	9.10
55	\	\	\	8.40	8.96	10.08	10.93	14.92	13.31	14.01	13.87	12.61	11.07	8.68
60	\	\	\	\	8.54	9.52	10.37	15.16	12.61	13.31	13.17	11.91	10.51	8.12

Heating Capacity Correction_16														
Outflow heated Water(°C)	Ambient Temp.(°C)													
	-25	-20	-15	-10	-7	-2	2	7	10	15	20	25	30	35
25	6.66	8.05	9.60	10.99	11.77	13.16	14.56	14.95	14.71	15.48	15.33	13.94	12.23	9.60
30	6.50	7.90	9.29	10.68	11.46	12.70	14.09	15.24	15.48	16.41	16.26	14.71	12.85	10.07
35	6.35	7.43	8.67	10.07	10.84	12.08	13.16	15.54	15.95	16.88	16.72	15.18	13.32	10.37
40	6.35	7.43	8.67	10.07	10.84	12.08	13.16	15.83	15.95	16.88	16.72	15.18	13.32	10.37
45	\	7.43	8.67	10.07	10.84	12.08	13.16	16.13	15.95	16.88	16.72	15.18	13.32	10.37
50	\	\	8.36	9.76	10.53	11.77	12.70	16.43	15.48	16.41	16.26	14.71	12.85	10.07
55	\	\	\	9.29	9.91	11.15	12.08	16.72	14.71	15.48	15.33	13.94	12.23	9.60
60	\	\	\	\	9.45	10.53	11.46	17.02	13.94	14.71	14.56	13.16	11.61	8.98

◆ COP Correction

(1) 1-Phase units

COP Correction_4														
Outflow heated Water(°C)	Ambient Temp.(°C)													
	-25	-20	-15	-10	-7	-2	2	7	10	15	20	25	30	35
25	2.03	2.57	3.04	3.86	4.45	5.27	6.05	6.32	6.59	7.22	7.64	7.61	8.27	8.74
30	1.64	2.11	2.50	3.24	3.74	4.41	5.19	5.73	6.08	6.51	6.94	6.94	7.49	8.03
35	1.37	1.72	2.03	2.69	3.12	3.74	4.25	5.11	5.38	5.85	6.12	6.12	6.79	7.22
40	1.17	1.56	1.87	2.42	2.77	3.39	3.94	4.52	4.76	5.19	5.42	5.38	5.97	6.36
45	\	1.33	1.60	2.15	2.42	2.93	3.43	3.90	4.10	4.45	4.68	4.91	5.15	5.46
50	\	\	1.33	1.76	2.03	2.46	2.85	3.32	3.47	3.78	3.98	4.17	4.37	4.64
55	\	\	\	1.40	1.64	1.99	2.30	2.69	2.81	3.08	3.24	3.39	3.55	3.78
60	\	\	\	\	1.29	1.52	1.76	2.11	2.18	2.30	2.46	2.57	2.69	2.89

COP Correction_6														
Outflow heated Water(°C)	Ambient Temp.(°C)													
	-25	-20	-15	-10	-7	-2	2	7	10	15	20	25	30	35
25	1.95	2.46	2.93	3.71	4.29	5.07	5.85	6.08	6.36	6.94	7.37	7.29	7.96	8.42
30	1.56	2.03	2.42	3.12	3.63	4.29	4.99	5.54	5.89	6.28	6.71	6.71	7.25	7.76
35	1.33	1.68	1.99	2.61	3.04	3.63	4.17	4.99	5.27	5.73	5.97	5.97	6.63	7.02
40	1.13	1.52	1.83	2.38	2.73	3.32	3.90	4.45	4.68	5.07	5.34	5.30	5.85	6.24
45	\	1.33	1.60	2.15	2.42	2.93	3.43	3.90	4.10	4.45	4.68	4.91	5.15	5.46
50	\	\	1.37	1.79	2.07	2.46	2.85	3.35	3.51	3.86	4.02	4.21	4.41	4.72
55	\	\	\	1.48	1.72	2.07	2.42	2.81	2.96	3.20	3.39	3.51	3.71	3.98
60	\	\	\	\	1.37	1.64	1.91	2.26	2.34	2.50	2.61	2.77	2.89	3.08

Air-to-water Heat Pump Split Unitherm

COP Correction_8														
Outflow heated Water(°C)	Ambient Temp.(°C)													
	-25	-20	-15	-10	-7	-2	2	7	10	15	20	25	30	35
25	1.81	2.29	2.70	3.44	4.00	4.70	5.40	5.66	5.88	6.44	6.81	6.77	7.36	7.81
30	1.48	1.92	2.26	2.92	3.40	4.00	4.66	5.18	5.48	5.88	6.25	6.25	6.77	7.22
35	1.22	1.55	1.85	2.44	2.85	3.40	3.89	4.66	4.92	5.33	5.55	5.55	6.18	6.55
40	1.07	1.44	1.74	2.22	2.55	3.11	3.66	4.18	4.40	4.81	5.03	5.00	5.51	5.88
45	\	1.26	1.52	2.04	2.29	2.78	3.26	3.70	3.89	4.22	4.44	4.66	4.88	5.18
50	\	\	1.30	1.74	1.96	2.37	2.74	3.22	3.37	3.70	3.89	4.07	4.26	4.55
55	\	\	\	1.44	1.67	2.04	2.37	2.74	2.89	3.15	3.29	3.44	3.63	3.89
60	\	\	\	\	1.37	1.63	1.89	2.26	2.29	2.48	2.59	2.74	2.85	3.07

COP Correction_10														
Outflow heated Water(°C)	Ambient Temp.(°C)													
	-25	-20	-15	-10	-7	-2	2	7	10	15	20	25	30	35
25	1.80	2.27	2.70	3.42	3.96	4.68	5.40	5.62	5.87	6.41	6.80	6.73	7.34	7.78
30	1.44	1.87	2.23	2.88	3.35	3.96	4.61	5.11	5.44	5.80	6.19	6.19	6.70	7.16
35	1.22	1.55	1.84	2.41	2.81	3.35	3.85	4.61	4.86	5.29	5.51	5.51	6.12	6.48
40	1.04	1.40	1.69	2.20	2.52	3.06	3.60	4.10	4.32	4.68	4.93	4.90	5.40	5.76
45	\	1.22	1.48	1.98	2.23	2.70	3.17	3.60	3.78	4.10	4.32	4.54	4.75	5.04
50	\	\	1.26	1.66	1.91	2.27	2.63	3.10	3.24	3.56	3.71	3.89	4.07	4.36
55	\	\	\	1.37	1.58	1.91	2.23	2.59	2.74	2.95	3.13	3.24	3.42	3.67
60	\	\	\	\	1.26	1.51	1.76	2.09	2.16	2.30	2.41	2.56	2.66	2.84

COP Correction_12														
Outflow heated Water(°C)	Ambient Temp.(°C)													
	-25	-20	-15	-10	-7	-2	2	7	10	15	20	25	30	35
25	1.95	2.47	2.90	3.70	4.30	5.05	5.81	6.23	6.32	6.92	7.32	7.28	7.91	8.39
30	1.59	2.07	2.43	3.14	3.66	4.30	5.01	5.62	5.89	6.32	6.72	6.72	7.28	7.76
35	1.31	1.67	1.99	2.63	3.06	3.66	4.18	5.00	5.29	5.73	5.97	5.97	6.64	7.04
40	1.15	1.55	1.87	2.39	2.74	3.34	3.94	4.39	4.73	5.17	5.41	5.37	5.93	6.32
45	\	1.35	1.63	2.19	2.47	2.98	3.50	3.77	4.18	4.53	4.77	5.01	5.25	5.57
50	\	\	1.39	1.87	2.11	2.55	2.94	3.16	3.62	3.98	4.18	4.38	4.57	4.89
55	\	\	\	1.55	1.79	2.19	2.55	2.54	3.10	3.38	3.54	3.70	3.90	4.18
60	\	\	\	\	1.47	1.75	2.03	1.93	2.47	2.66	2.78	2.94	3.06	3.30

COP Correction_14														
Outflow heated Water(°C)	Ambient Temp.(°C)													
	-25	-20	-15	-10	-7	-2	2	7	10	15	20	25	30	35
25	1.83	2.32	2.73	3.47	4.04	4.75	5.46	5.72	5.94	6.50	6.88	6.84	7.44	7.88
30	1.49	1.94	2.28	2.95	3.44	4.04	4.71	5.21	5.53	5.94	6.31	6.31	6.84	7.29
35	1.23	1.57	1.87	2.47	2.88	3.44	3.92	4.70	4.97	5.38	5.60	5.60	6.24	6.61
40	1.08	1.46	1.76	2.24	2.58	3.14	3.70	4.19	4.45	4.86	5.08	5.04	5.57	5.94
45	\	1.27	1.53	2.06	2.32	2.80	3.29	3.68	3.92	4.26	4.48	4.71	4.93	5.23
50	\	\	1.31	1.76	1.98	2.39	2.76	3.17	3.40	3.74	3.92	4.11	4.30	4.60
55	\	\	\	1.46	1.68	2.06	2.39	2.66	2.91	3.18	3.33	3.47	3.66	3.92
60	\	\	\	\	1.38	1.64	1.91	2.15	2.32	2.50	2.62	2.76	2.88	3.10

COP Correction_16														
Outflow heated Water(°C)	Ambient Temp.(°C)													
	-25	-20	-15	-10	-7	-2	2	7	10	15	20	25	30	35
25	1.74	2.21	2.60	3.31	3.85	4.52	5.20	5.38	5.66	6.20	6.55	6.52	7.09	7.51
30	1.42	1.85	2.17	2.81	3.28	3.85	4.49	4.94	5.27	5.66	6.02	6.02	6.52	6.94
35	1.18	1.50	1.78	2.35	2.74	3.28	3.74	4.50	4.74	5.13	5.34	5.34	5.95	6.30
40	1.03	1.39	1.67	2.14	2.46	2.99	3.53	4.06	4.24	4.63	4.84	4.81	5.31	5.66
45	\	1.21	1.46	1.96	2.21	2.67	3.13	3.62	3.74	4.06	4.27	4.49	4.70	4.99
50	\	\	1.25	1.67	1.89	2.28	2.64	3.18	3.24	3.56	3.74	3.92	4.09	4.38
55	\	\	\	1.39	1.60	1.96	2.28	2.74	2.78	3.03	3.17	3.31	3.49	3.74
60	\	\	\	\	1.32	1.57	1.82	2.30	2.21	2.39	2.49	2.64	2.74	2.96

(2) 3-Phase units

COP Correction_8														
Outflow heated Water(°C)	Ambient Temp.(°C)													
	-25	-20	-15	-10	-7	-2	2	7	10	15	20	25	30	35
25	2.04	2.58	3.04	3.87	4.49	5.28	6.07	6.36	6.61	7.24	7.65	7.61	8.28	8.78
30	1.66	2.16	2.54	3.29	3.83	4.49	5.24	5.82	6.16	6.61	7.03	7.03	7.61	8.11
35	1.37	1.75	2.08	2.75	3.20	3.83	4.37	5.24	5.53	5.99	6.24	6.24	6.95	7.36
40	1.21	1.62	1.96	2.50	2.87	3.49	4.12	4.70	4.95	5.41	5.66	5.62	6.20	6.61
45	\	1.41	1.71	2.29	2.58	3.12	3.66	4.16	4.37	4.74	4.99	5.24	5.49	5.82
50	\	\	1.46	1.96	2.20	2.66	3.08	3.62	3.79	4.16	4.37	4.58	4.78	5.12
55	\	\	\	1.62	1.87	2.29	2.66	3.08	3.24	3.54	3.70	3.87	4.08	4.37
60	\	\	\	\	1.54	1.83	2.12	2.54	2.58	2.79	2.91	3.08	3.20	3.45

COP Correction_10														
Outflow heated Water(°C)	Ambient Temp.(°C)													
	-25	-20	-15	-10	-7	-2	2	7	10	15	20	25	30	35
25	2.00	2.52	3.00	3.80	4.40	5.20	6.00	6.24	6.52	7.12	7.56	7.48	8.16	8.64
30	1.60	2.08	2.48	3.20	3.72	4.40	5.12	5.68	6.04	6.44	6.88	6.88	7.44	7.96
35	1.36	1.72	2.04	2.68	3.12	3.72	4.28	5.12	5.40	5.88	6.12	6.12	6.80	7.20
40	1.16	1.56	1.88	2.44	2.80	3.40	4.00	4.56	4.80	5.20	5.48	5.44	6.00	6.40
45	\	1.36	1.64	2.20	2.48	3.00	3.52	4.00	4.20	4.56	4.80	5.04	5.28	5.60
50	\	\	1.40	1.84	2.12	2.52	2.92	3.44	3.60	3.96	4.12	4.32	4.52	4.84
55	\	\	\	1.52	1.76	2.12	2.48	2.88	3.04	3.28	3.48	3.60	3.80	4.08
60	\	\	\	\	1.40	1.68	1.96	2.32	2.40	2.56	2.68	2.84	2.96	3.16

COP Correction_12														
Outflow heated Water(°C)	Ambient Temp.(°C)													
	-25	-20	-15	-10	-7	-2	2	7	10	15	20	25	30	35
25	2.06	2.60	3.07	3.90	4.53	5.33	6.13	6.58	6.68	7.31	7.73	7.68	8.36	8.86
30	1.68	2.18	2.56	3.32	3.86	4.53	5.29	5.93	6.21	6.68	7.10	7.10	7.68	8.19
35	1.39	1.76	2.10	2.77	3.23	3.86	4.41	5.28	5.58	6.05	6.30	6.30	7.01	7.43
40	1.22	1.64	1.97	2.52	2.90	3.53	4.16	4.63	5.00	5.46	5.71	5.67	6.26	6.68
45	\	1.43	1.72	2.31	2.60	3.15	3.70	3.98	4.41	4.79	5.04	5.29	5.54	5.88
50	\	\	1.47	1.97	2.23	2.69	3.11	3.33	3.82	4.20	4.41	4.62	4.83	5.16
55	\	\	\	1.64	1.89	2.31	2.69	2.68	3.28	3.57	3.74	3.90	4.11	4.41
60	\	\	\	\	1.55	1.85	2.14	2.03	2.60	2.81	2.94	3.11	3.23	3.49



Parts List of CH-HP4.0SIRK4(I), CH-HP6.0SIRK4(I)

No.	Name of part	Quantity
1	Expansion Drum	1
2	Handle	2
3	Plate-type Heat Exchanger Sub-Assy	1
4	Auto Air Outlet Valve	1
5	Electric Heater	1
6	Relief Valve	1
7	Electric starter of water valve	1
8	Water Pressure Gauge	1
9	Water Pump	1
10	Steam current Switch	1
11	Strainer	1
12	Bipolar AC Contactor	3
13	Terminal Board	1
14	Terminal Board	1
15	Terminal Board	1
16	Main Board	1
17	Display Board	1
18	Electric Box Assy	1
19	Jumper	1
20	Thermostat	1
21	Sensor Sub-assy	1
22	Temperature Sensor	1

(2) CH-HP4.0SIRK4(O), CH-HP6.0SIRK4(O)

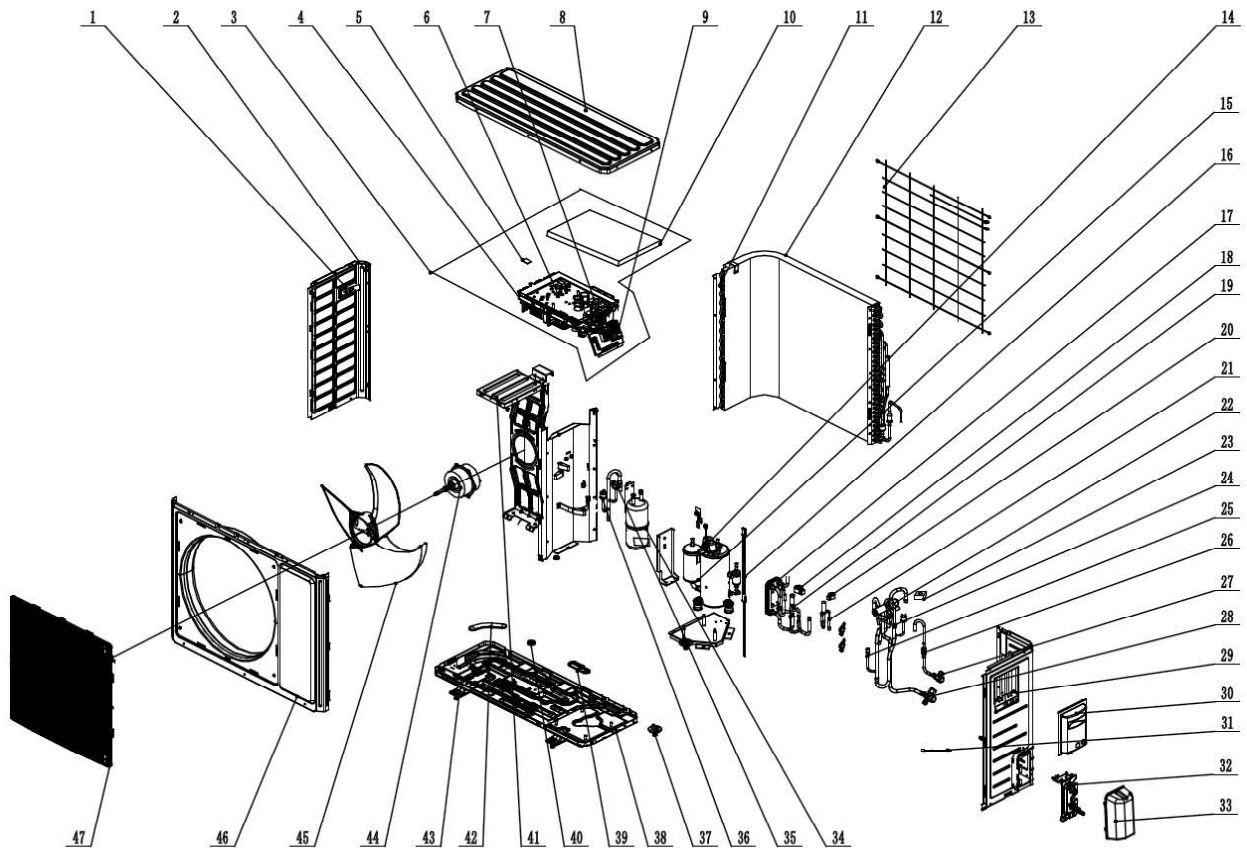

Air-to-water Heat Pump Split Unitherm

Parts List of CH-HP4.0SIRK4(O), CH-HP6.0SIRK4(O)

No.	Name of part	Quantity
1	Handle	1
2	Left Side Plate	1
3	Electric Box Assy	1
4	Radiator	1
5	Jumper	1
6	Main Board	1
7	Terminal Board	1
8	Top Cover Sub-Assy	1
9	Communication Interface Board	1
10	Electric Box Cover	1
11	Supporting Board(Condenser)	1
12	Condenser Assy	1
13	Rear Grill	1
14	Pressure Sensor	1
15	Compressor and Fittings	1
16	Electrical Heater	1
17	Plate-type Heat Exchanger	1
18	Electric Expand Valve Fitting	1
19	Electronic Expansion Valve	1
20	Electric Expand Valve Fitting	1
21	Electronic Expansion Valve	1
22	4-Way Valve	1
23	Magnet Coil	1
24	Pressure Protect Switch	1
25	Nozzle for Adding Freon	1
26	Strainer	1
27	Cut-off valve 1/4(N)	1
28	Cut-off valve 1/2(N)	1
29	Right Side Plate Assy	1
30	Handle	1
31	Sensor Sub-assy	1
32	Valve Support Sub-Assy	1
33	Valve Cover	1
34	Gas-liquid Separator Assy	1
35	Pressure Protect Switch	1
36	Pressure Protect Switch	1
37	Drainage Joint	1
38	Chassis Sub-assy	1
39	Drainage hole Cap	1
40	Drainage hole Cap	1
41	Motor Support Sub-Assy	1
42	Drainage hole Cap	1
43	Electrical Heater (Chassis)	1
44	Fan Motor	1
45	Axial Flow Fan	1
46	Front Panel Assy	1
47	Front Grill	1



(3) CH-HP8.0SIRK4(I), CH-HP10SIRK4(I)

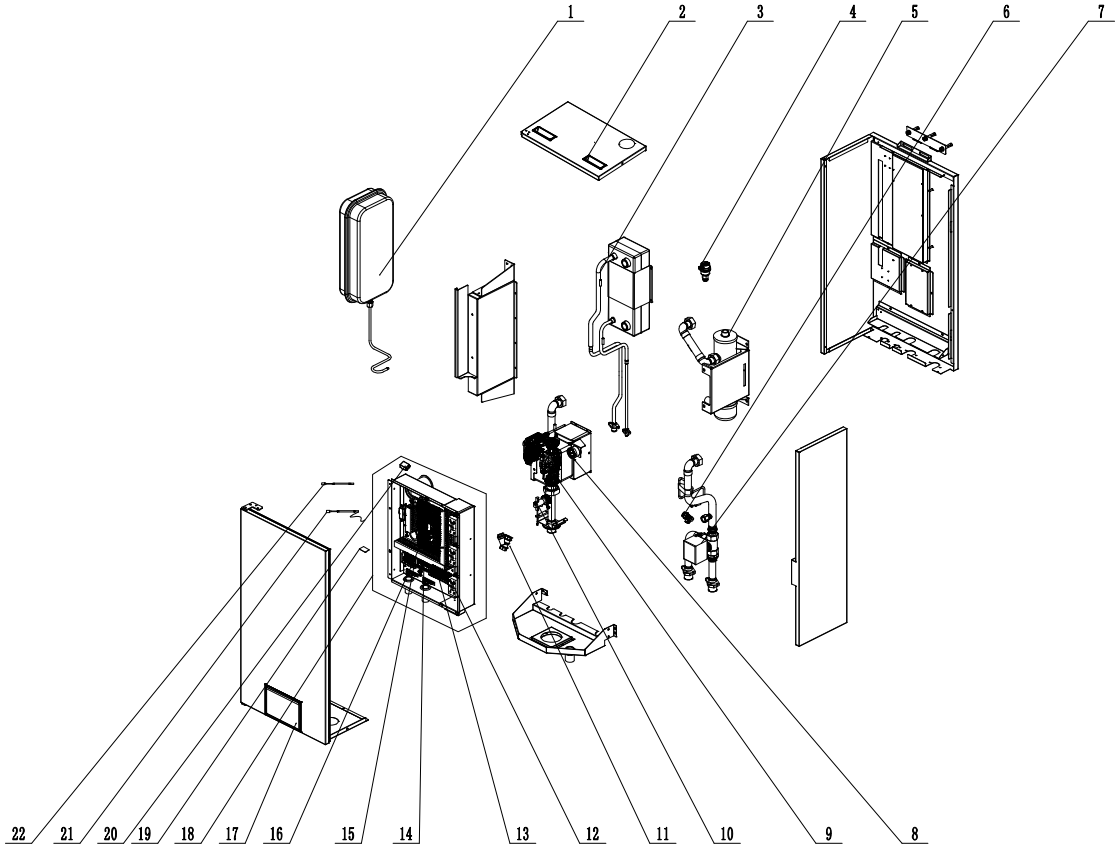

Parts List of CH-HP8.0SIRK4(I), CH-HP10SIRK4(I)

No.	Name of part	Quantity
1	Expansion Drum	1
2	Handle	2
3	Plate-type Heat Exchanger Sub-Assy	1
4	Auto Air Outlet Valve	1
5	Electric Heater	1
6	Relief Valve	1
7	Electric starter of water valve	1
8	Water Pressure Gauge	1
9	Water Pump	1
10	Steam current Switch	1
11	Strainer	1
12	Bipolar AC Contactor	3
13	Terminal Board	1
14	Terminal Board	1
15	Terminal Board	1
16	Main Board	1
17	Display Board	1
18	Electric Box Assy	1
19	Jumper	1
20	Thermostat	1
21	Sensor Sub-assy	1
22	Temperature Sensor	1

Air-to-water Heat Pump Split Unitherm

(4) CH-HP8.0SIRK4(O), CH-HP10SIRK4(O)

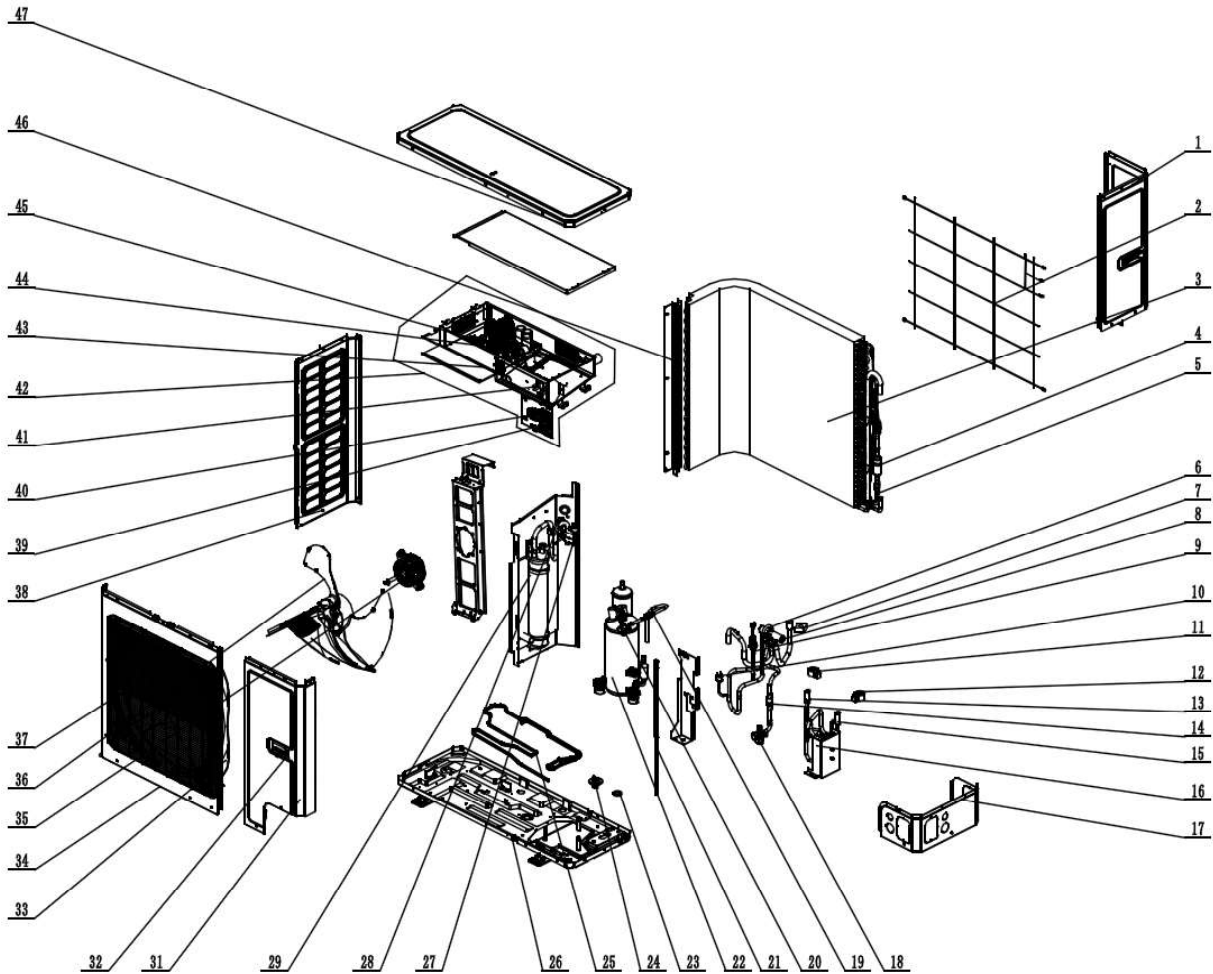

Parts List of CH-HP8.0SIRK4(O), CH-HP10SIRK4(O)

No.	Name of part	Quantity
1	Rear Side Plate	1
2	Rear Grill	1
3	Condenser Assy	1
4	Silencer	1
5	Strainer	1
6	4-Way Valve Assy	1
7	Magnet Coil	1
8	4-way Valve	1
9	Pressure Sensor	1
10	Pressure Protect Switch	1
11	Electric Expand Valve Fitting	1
12	Electric Expand Valve Fitting	1
13	Electronic Expansion Valve	1
14	Strainer	1
15	Electronic Expansion Valve	1
16	Plate-type Heat Exchanger	1
17	Right Side Plate Sub-Assy	1
18	Cut off Valve	1
19	Filter	1
20	Cut-off valve 1/4(N)	1

No.	Name of part	Quantity
21	Electric Heater(Compressor)	1
22	Compressor and Fittings	1
23	Drainage hole Cap	3
24	Drainage Joint	1
25	Electrical Heater	1
26	Chassis	1
27	Pressure Protect Switch	1
28	Pressure Protect Switch	1
29	Gas-liquid Separator	1
30	Motor Support Sub-Assy	1
31	Front Side Plate	1
32	Handle	2
33	Diversion Circle	1
34	Cabinet	1
35	BrushlessDCMotor	1
36	Axial Flow Fan	1
37	Front Grill	1
38	Left Side Plate	1
39	Communication Board	1
40	Terminal Board	1
41	Filter Board	1
42	Electric Box Assy	1
43	Radiator	1
44	Main Board	1
45	Main Board	1
46	Supporting Strip(Condenser)	1
47	Coping	1

# Air-to-water Heat Pump Split Unitherm

(5) CH-HP12SIRK4(I), CH-HP14SIRK4(I), CH-HP16SIRK4(I)

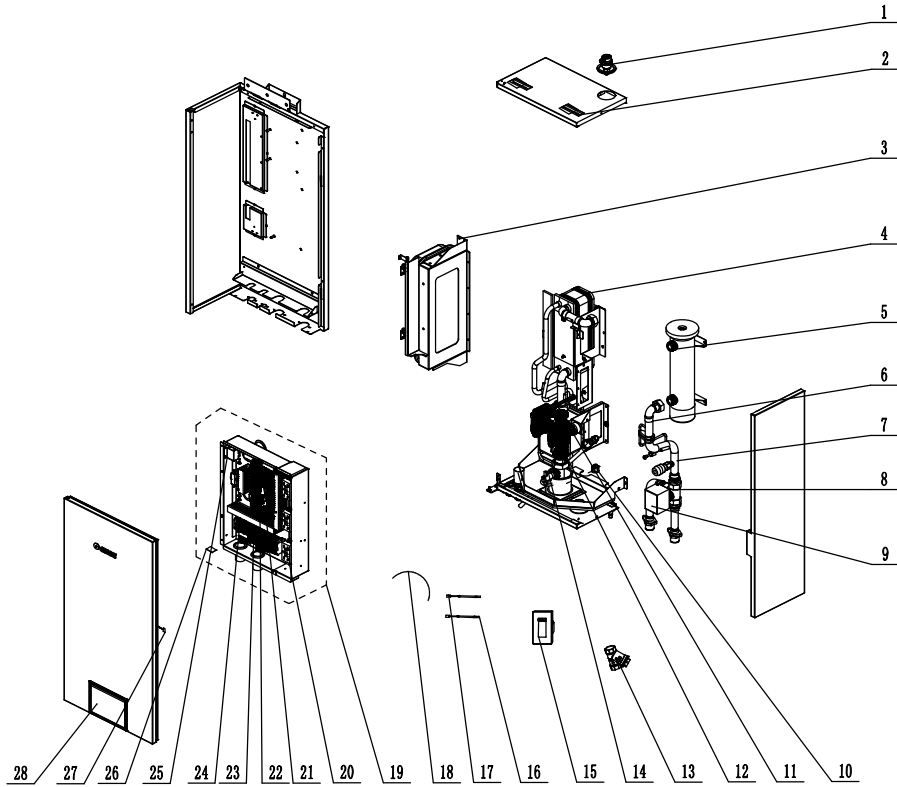

Parts List of CH-HP12SIRK4(I), CH-HP14SIRK4(I), CH-HP16SIRK4(I)

No.	Name of part	Quantity
1	Auto Air Outlet Valve	1
2	Handle	2
3	Expansion Drum	1
4	Plate-type Heat Exchanger Sub-Assy	1
5	Electric Heater	1
6	Drainage Pipe Sub-assy	1
7	Relief Valve	1
8	Electric three-way ball valve body	1
9	Electric starter of water valve	1
10	Sealing Cap(Pressure Warning)	1
11	Water Pressure Gauge	1
12	Water Pump	1
13	Strainer	1
14	Flow switch	1
15	Remote room temperature sensor	1
16	Temperature Sensor	1
17	Temperature Sensor	1
18	Signal Wire	1
19	Electric Box Assy	1
20	Bipolar AC Contactor	3
21	mounting card(main board)	1
22	Main Board	1
23	Terminal Board	1
24	Terminal Board	1
25	Thermostat	1
26	Jumper	1
27	Magnet Sub-assy	2
28	Display Board	1

(6) CH-HP12SIRK4(O), CH-HP14SIRK4(O), CH-HP16SIRK4(O)

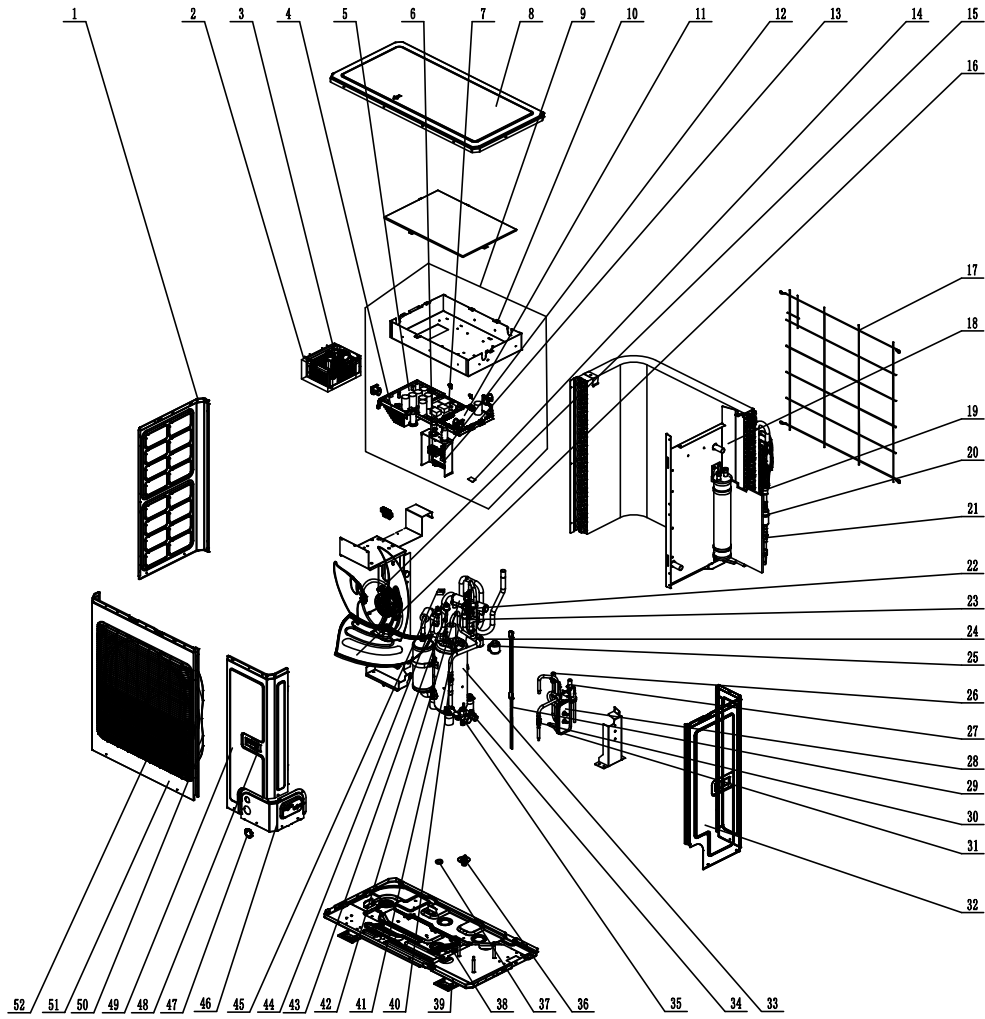

Parts List of CH-HP12SIRK4(O), CH-HP14SIRK4(O), CH-HP16SIRK4(O)

No.	Name of part	Quantity
1	Left Side Plate	1
2	Inductance Box Assy	1
3	Inductance	1
4	Radiator	1
5	Drive Board	1
6	Terminal board	1
7	Filter Board	1
8	Coping	1
9	Electric Box Assy	1
10	Electric Box	1
11	Main Board	1
12	Communication Interface Board	1
13	Electrical Retaining Plate	1
14	Jumper	1
15	Brushless DC Motor	1
16	Axial Flow Fan	1
17	Rear Grill	1
18	Condenser Assy	1
19	Current Divider	1
20	Silencer	1
21	Strainer	1
22	Pressure Sensor	1
23	Nozzle for Adding Freon	1

Air-to-water Heat Pump Split Unitherm

No.	Name of part	Quantity
24	Electric Expand Valve Fitting	1
25	Electric Expand Valve Fitting	1
26	Electronic Expansion Valve	1
27	Electronic Expansion Valve	1
28	Plate-type Heat Exchanger	1
29	Electrical Heater	1
30	Strainer	1
31	Energy saver sub-assy	1
32	Rear Side Plate	1
33	Compressor and Fittings	1
34	Cut-off valve 1/4(N)	1
35	Cut-off valve 5/8	1
36	Drainage Joint	1
37	Drainage hole Cap	3
38	Electrical Heater	1
39	Foot	2
40	Filter	1
41	Pressure Protect Switch	1
42	4-Way Valve	1
43	Pressure Protect Switch	1
44	Pressure Protect Switch	1
45	Magnet Coil	1
46	Valve Support Sub-Assy	1
47	Gland Bush	1
48	Handle	2
49	Front Side Plate	1
50	Diversion Circle	1
51	Cabinet	1
52	Front Grill	1

(7) CH-HP8SIRM4(I), CH-HP10SIRM4(I)

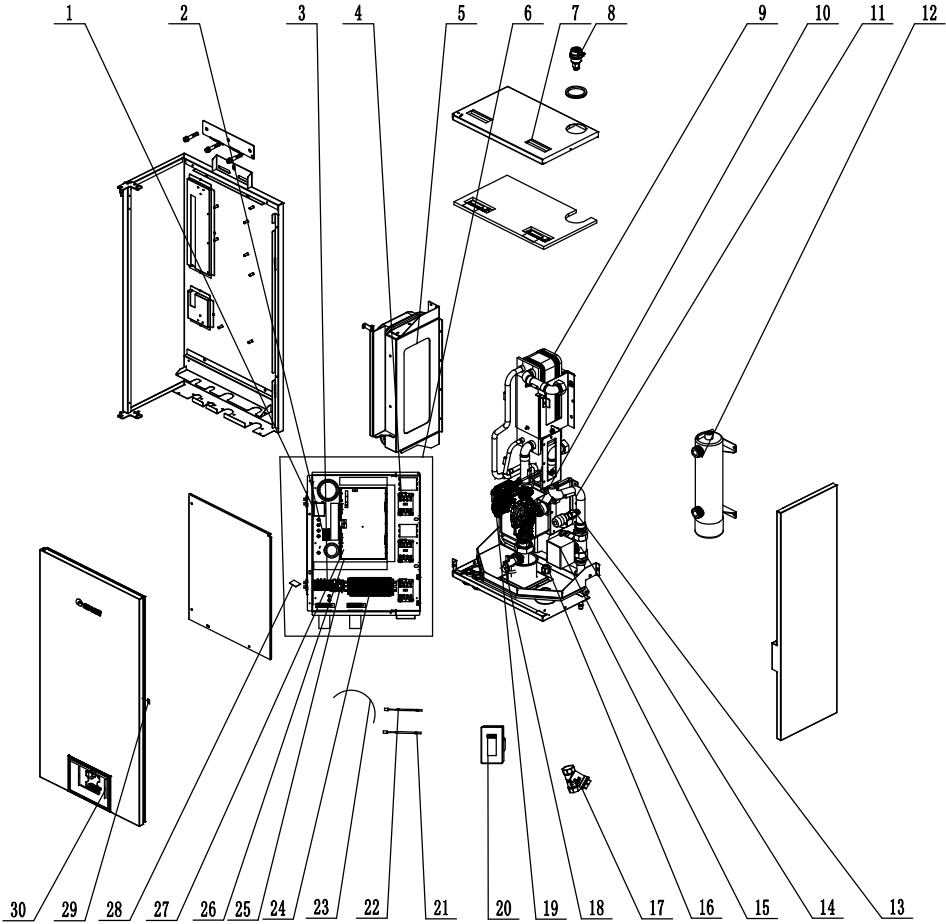

Parts List of CH-HP8SIRM4(I), CH-HP10SIRM4(I)

No	Name of part	Quantity
1	Display Board	1
2	Magnet Sub-assy	2
3	Jumper	1
4	Main Board	1
5	Mounting board	1
6	Terminal Board	1
7	Terminal Board	1
8	Communication line	1
9	Temperature Sensor	1
10	Temperature Sensor	1
11	Remote room temperature sensor	1
12	Water Pump	1
13	Flow switch	1
14	Strainer	1
15	Sealing Cap(Pressure Warning)	1
16	Electric starter of water valve	1
17	Electric three-way ball valve body	1
18	Relief Valve	1
19	Electric Heater	1
20	Drainage Pipe Sub-assy	1
21	Water Pressure Gauge	1

Air-to-water Heat Pump Split Unitherm

No	Name of part	Quantity
22	Plate-type Heat Exchanger Sub-Assy	1
23	Auto Air Outlet Valve	1
24	Handle	2
25	Electric Box Assy	1
26	Expansion Drum	1
27	AC Contactor	3
28	Terminal Board	1
29	Terminal Board	1
30	Thermostat	1

(8) CH-HP8SIRM4(O), CH-HP10SIRM4(O)

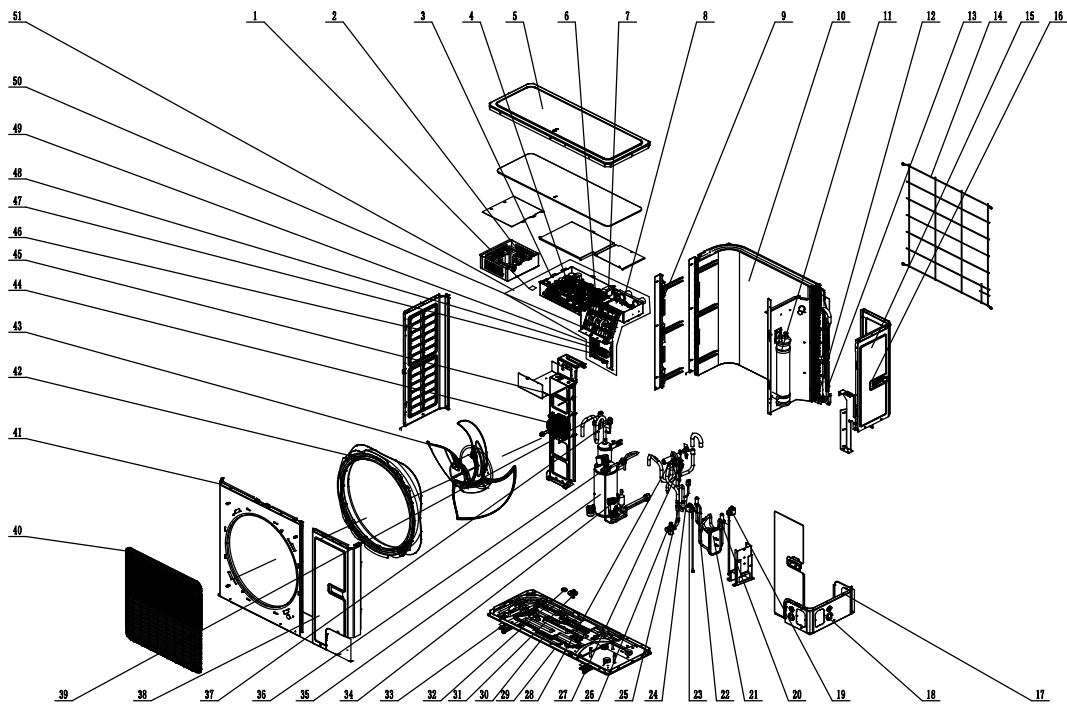

Parts List of CH-HP8SIRM4(O), CH-HP10SIRM4(O)

No.	Name of part	Quantity
1	Jumper	1
2	Reactor	3
3	Electric Box	1
4	Drive Board	1
5	Coping	1
6	Mouting plate	1
7	Inductance	1
8	Main Board	1
9	Supporting Strip(Condenser)	1
10	Condenser Assy	1
11	Gas-liquid Separator	1
12	Current Divider	2
13	Strainer	1
14	Rear Grill	1
15	Rear Side Plate	1
16	Handle	2
17	Right Side Plate Sub-Assy	1
18	Gland Bush	2
19	Electric Expand Valve Fitting	1
20	Electronic Expansion Valve	1
21	Plate-type Heat Exchanger	1



No.	Name of part	Quantity
22	Electronic Expansion Valve	1
23	Electric Expand Valve Fitting	1
24	Pressure Protect Switch	1
25	Filter	1
26	Cut off Valve	1
27	Pressure Sensor	1
28	4-Way Valve Sub-Assy	1
29	Chassis	1
30	Electrical Heater	1
31	Drainage Joint	1
32	Drainage hole Cap	3
33	Foot	2
34	Strainer	1
35	Compressor and Fittings	1
36	Cut-off valve 1/4(N)	1
37	Pressure Protect Switch	1
38	Front Side Plate	1
39	Pressure Protect Switch	1
40	Front Grill	1
41	Cabinet Assy	1
42	Diversion Circle	1
43	Axial Flow Fan	1
44	Brushless DC Motor	1
45	Motor Support Sub-Assy	1
46	Left Side Plate	1
47	Terminal Board	1
48	Communication Interface Board	1
49	Electrical Retaining Plate	1
50	Filter Board	1
51	Electric Box Assy	1

# Air-to-water Heat Pump Split Unitherm

(9) CH-HP12SIRM4(I), CH-HP14SIRM4(I), CH-HP16SIRM4(I)

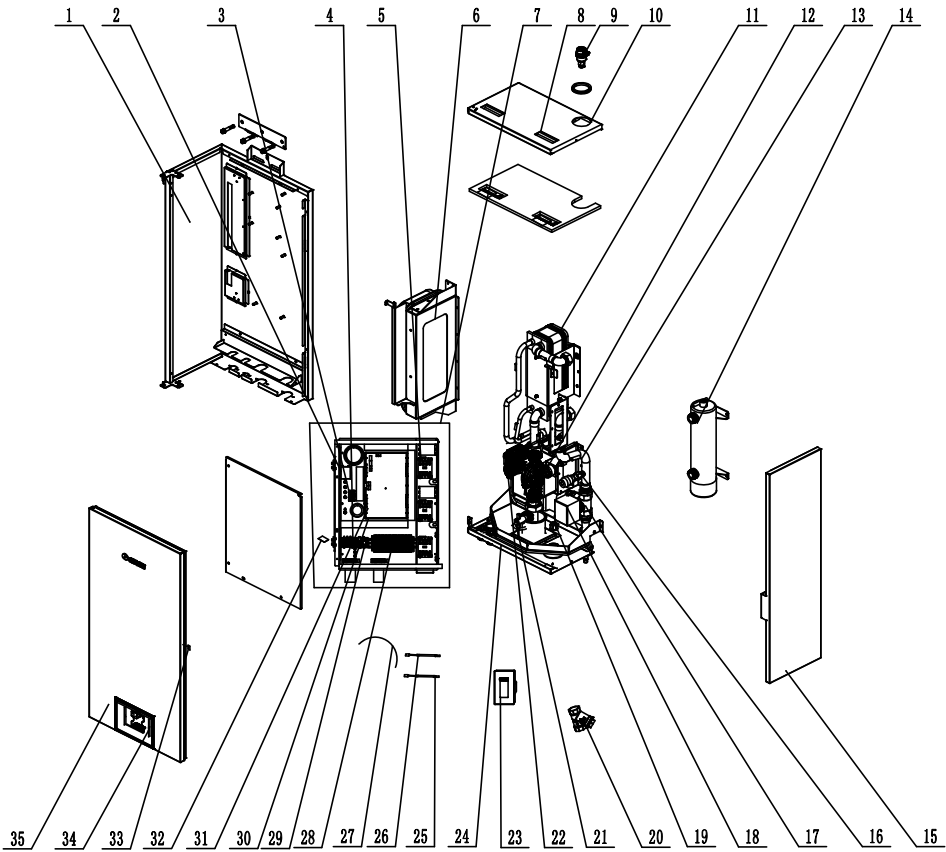

Parts List of CH-HP12SIRM4(I), CH-HP14SIRM4(I), CH-HP16SIRM4(I)

No	Name of part	Quantity
1	Chassis Sub-as	1
2	Thermostat	1
3	Terminal Board	1
4	Terminal Board	1
5	AC Contactor	3
6	Expansion Drum	1
7	Electric Box Assy	1
8	Handle	2
9	Auto Air Outlet Valve	1
10	Cover Plate	1
11	Plate-type Heat Exchanger Sub-Assy	1
12	Water Pressure Gauge	1
13	Drainage Pipe Sub-assy	1
14	Electric Heater	1
15	Right Side Plate	1
16	Relief Valve	1
17	Electric three-way ball valve body	1
18	Electric starter of water valve	1
19	Sealing Cap(Pressure Warning)	1
20	Strainer	1
21	Flow switch	1
22	Water Pump	1
23	Remote room temperature sensor	1
24	Connection Board	1

No	Name of part	Quantity
25	Temperature Sensor	1
26	Temperature Sensor	1
27	Communication line	1
28	Terminal Board	1
29	Terminal Board	1
30	Mounting board	1
31	Main Board	1
32	Jumper	1
33	Magnet Sub-assy	2
34	Display Board	1
35	Front Panel Sub-Assy	1

(10) CH-HP12SIRM4(O), CH-HP14SIRM4(O), CH-HP16SIRM4(O)

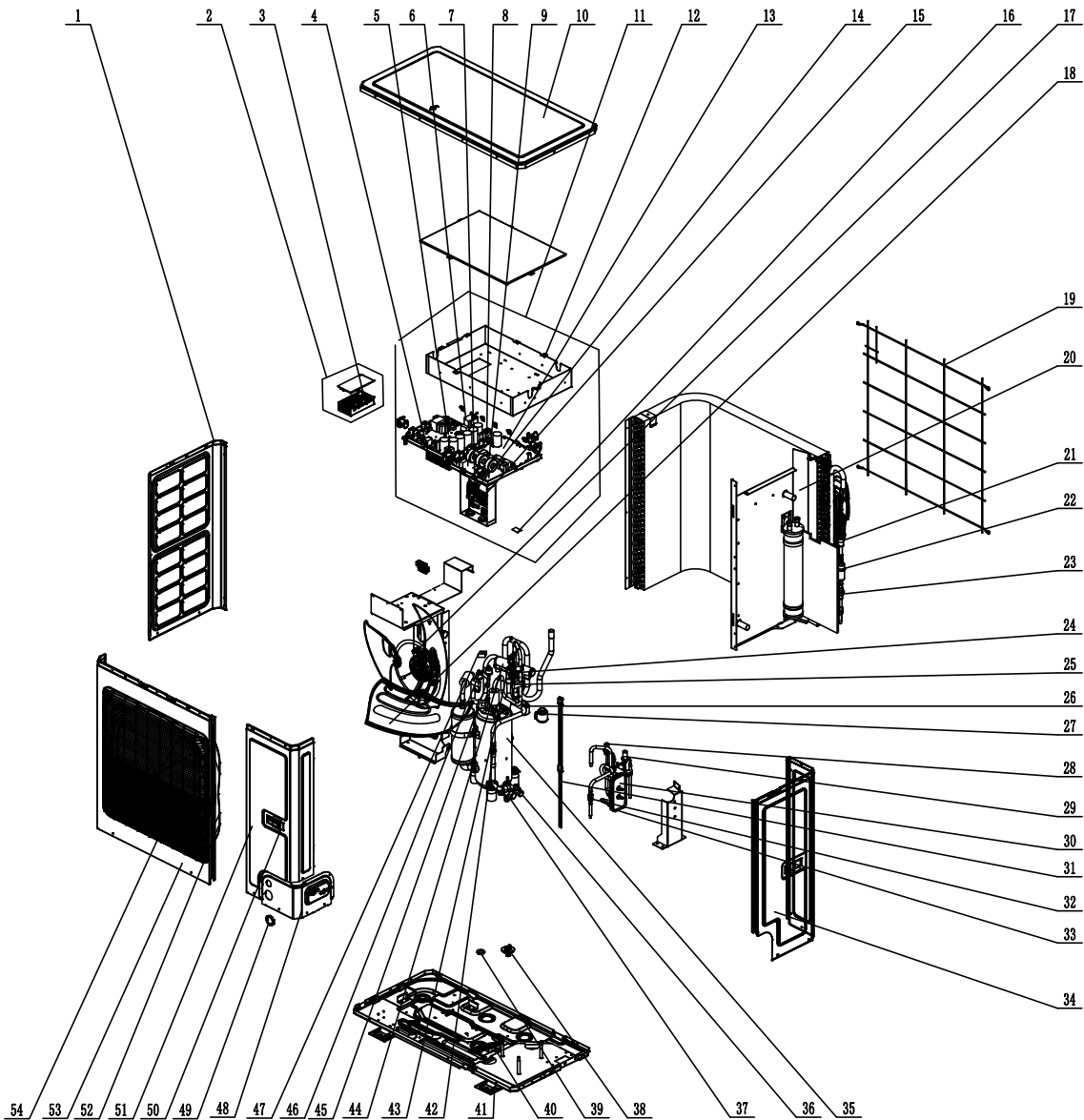

Air-to-water Heat Pump Split Unitherm

Parts List of CH-HP12SIRM4(O), CH-HP14SIRM4(O), CH-HP16SIRM4(O)

No	Name of part	Quantity
1	Left Side Plate	1
2	Inductance Box Assy	1
3	Reactor	3
4	Radiator	1
5	Main Board	1
6	Inductance	1
7	Communication Interface Board	1
8	Terminal board	1
9	Filter Board	1
10	Coping	1
11	Electric Box Assy	1
12	Electric Box	1
13	Main Board	1
14	Electrical Retaining Plate	1
15	Terminal board	1
16	Jumper	1
17	Brushless DC Motor	1
18	Axial Flow Fan	1
19	Rear Grill	1
20	Condenser Assy	1
21	Current Divider	1
22	Silencer	1
23	Strainer	1
24	Pressure Sensor	1
25	Nozzle for Adding Freon	1
26	Electric Expand Valve Fitting	1
27	Electric Expand Valve Fitting	1
28	Electronic Expansion Valve	1
29	Electronic Expansion Valve	1
30	Plate-type Heat Exchanger	1
31	Electrical Heater	1
32	Strainer	1
33	Energy saver sub-assy	1
34	Rear Side Plate	1
35	Compressor and Fittings	1
36	Cut-off valve 1/4(N)	1
37	Cut-off valve 5/8	1
38	Drainage Joint	1
39	Drainage hole Cap	3
40	Electrical Heater	1
41	Foot	2
42	Filter	1
43	Pressure Protect Switch	1
44	4-Way Valve	1
45	Pressure Protect Switch	1
46	Pressure Protect Switch	1
47	Magnet Coil	1
48	Valve Support Sub-Assy	1

No	Name of part	Quantity
49	Gland Bush	1
50	Handle	2
51	Front Side Plate	1
52	Diversion Circle	1
53	Cabinet	1
54	Front Grill	1

### 3 Supply Scope

S= Standard O= Optional F= Field Supplied

Name	Standard	Optional	Field Supplied
Owner's Manual for the Main Unit	√	/	/
Owner's Manual for the Control	√	/	/
2-way Valve	/	/	√
3-way Valve	√	/	/
Remote Temperature Sensor	√	/	/
Wired Controller	√	/	/
Communication Cable	√	/	/
Water Tank Temperature Sensor	√	/	/
Expansion Bolt	√	/	/
Other thermal	/	/	√
Optional Electric Heater	√	/	/

Name	Standard Part Code
Owner's Manual for the Main Unit	600005062359
Owner's Manual for the Control	600005060789
3-way Valve	4504800101(actuator) 072005000003(valve)
Remote Temperature Sensor	30261014
Wired Controller	300001060562
Communication Cable	4003014308(between indoor and outdoor units) 400300412(between the display panel and the indoor unit) 40038006(between the indoor unit and the remote room temperature sensor)
Water Tank Temperature Sensor	3900028316G
Support hook	012045060004P
Expansion Bolt	70110066
Optional Electric Heater	32000406007502(1.5+1.5kW): standard models CH-HP4.0SIRK4, CH-HP6.0SIRK4, 32000406006302(3+3kW): standard models CH-HP8.0SIRK4, CH-HP10SIRK4.

# Model Selection

## 1 General

### 1.1 Power Supply

Model	Power supply	
	V,Ph,Hz	
CH-HP4.0SIRK4	230VAC, 1Ph, 50Hz	
CH-HP6.0SIRK4		
CH-HP8.0SIRK4		
CH-HP10SIRK4		
CH-HP12SIRK4		
CH-HP14SIRK4		
CH-HP16SIRK4		
CH-HP8.0SIRM4		400V, 3N, 50 Hz
CH-HP10SIRM4		
CH-HP12SIRM4		
CH-HP14SIRM4		
CH-HP16SIRM4		

### 1.2 Operation Conditions

Capacities and power inputs are based on the following conditions (floor heating /cooling )	
a. Cooling conditions	b. Heating conditions
Indoor Water Temp 23°C/18°C;	Indoor Water Temp 30°C/35°C;
Outdoor Air Temp 35°C DB/24°C WB	Outdoor Air Temp 7°C DB/6°C WB
Capacities and power inputs are based on the following conditions (FCU or radiator)	
a. Cooling conditions	b. Heating conditions
Indoor Water Temp 12°C/7°C;	Indoor Water Temp 40°C/45°C;
Outdoor Air Temp 35°C DB/24°C WB	Outdoor Air Temp 7°C DB/6°C WB

### 1.3 Flowchart of Model Selection

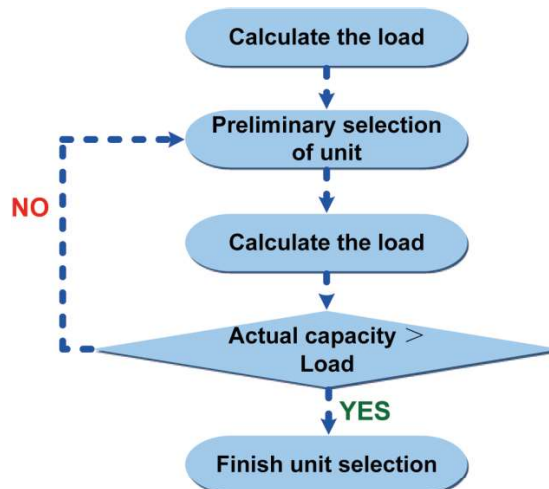

### 1.4 Design Principle

- (1) Cooling: capacity of the unit  $\geq$  cooling load of the air conditioning
- (2) Heating: capacity of the unit  $\geq$  max{ heating load, floor heating load, water heating load}

- (3) Water Tank: it should be selected based on the sanitary outfit or quantity of users. Each unit can accommodate only one water tank.

## 2 Selection of the Underfloor Coils

### 2.1 Calculation of Unit Load for Floor Heating

**Empirical Values of Floor Heating Load Per Square Meter**

House W/m <sup>2</sup>	
Dining Room	100~120
Master Room	100~110
Guest Room	110~130
Study Room	90~110
Villa W/m <sup>2</sup>	
Dining Room	110~140
Master Room	100~120
Guest Room	100~130
Study Room	100~120

**Notes:**

- (1) Villas whose load is generally larger than the houses should take the value between the middle and the maximum empirical values listed above.
- (2) The top layer whose load is generally larger than the middle or bottom layer should take the maximum empirical value.
- (3) The guest room whose load is generally much larger should take the value between the intermediate and the maximum empirical values listed above.
- (4) For those whose external walls or glass areas are large, it is recommended to take the load calculation.
- (5) The heating load for the bathroom is generally 500W/room.

### 2.2 Selection of Tube Spacing of the Underfloor Coils

Tube spacing of the underfloor coils which will directly affect heat dissipation of the floor depends on the tube material, indoor design temperature, supply water temperature and floor material.

**Heat Dissipation of Commonly Used Coils**

(Tube material: PE-X, Indoor temperature:18°C, Average water temperature:45°C)

Floor Material	Thermal Resistance m <sup>2</sup> ·K/W	Tube Spacing mm	Heat Dissipation W/m <sup>2</sup>	Tube Spacing mm	Heat Dissipation W/m <sup>2</sup>
Stone	0.02	200	147.0	150	159.8
Wood	0.075	200	111.2	150	117.8

The dissipated heat of the floor coil is larger than the load for the floor heating system; however the deviation cannot be larger than 10%.

### 2.3 Selection of Loop Quantity of Coils for Each Room

#### 2.3.1 Type of Underfloor Coils

When selecting underfloor coils, we should consider both their comfortability and heating capacity. The most commonly used coils are as shown below.

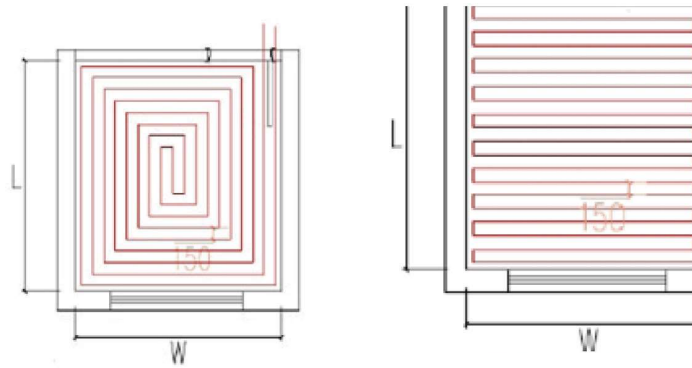

Square-shaped Coil (Recommended) U-shaped Coil

Length of coils is calculated as below:

Square-shaped coil:  $=L*W/\text{tube spacing}=\text{area}/\text{tube spacing}$

U-shaped coil:  $=L-1+L*W/\text{tube spacing}=L-1+\text{area}/\text{tube spacing}$

The reason why the square-shaped coils are recommended is because they can keep even temperature distribution. Special demand can be met by adjusting the tube spacing.

Distance from the room to the water manifold should be estimated according to the actual conditions of the project and generally should not exceed 30m.

### 2.3.2 Selection of Loop Quantity for Each Room

Length of a single loop should not exceed 100m. If so, it should be divided into multiple loops.

Area of a single loop= $\text{tube length} \times \text{tube spacing}=100\text{m} \times 150\text{mm}=15\text{m}^2$

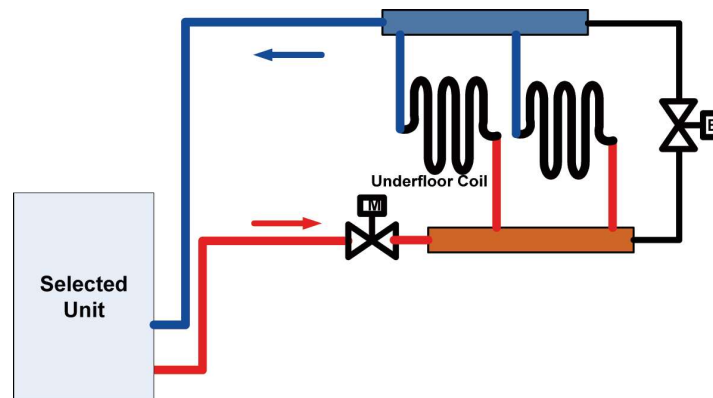

Length of underfloor coils is recommended to be within 100m and length of each branch should be kept the same to the most extent.

## 3 Quantity and Location of the Water Manifold

The water manifold is a kind of device for distributing water for the water supply and return tubes.

### 3.1 Design Requirements on Loop Quantity for Circulation Water

- (1) One water manifold is allowed for at most 8 loops. When quantity of loops exceeds 12, then two water manifold should be used, or it will cause uneven water distribution.
- (2) The maximum flow rate of the water manifold should be less than 0.8m/s.
- (3) The inlet and outlet of each loop should be connected to the water manifold and the inner diameter of the water manifold should be or larger than that of the main water supply/return tube.

Calculation of loop quantity for circulation water can be done as per the formula below:

$$N=A/A1$$

N—loop quantity

A— total floor heating area (unit:  $\text{m}^2$ )

A1— floor heating area per single loop (unit:  $\text{m}^2$ )



Example for how to calculating the floor heating area per single loop: when the tube length is 120m, and tube spacing is 200mm, then the floor heating area per single loop is  $120 \times 0.2 = 24\text{m}^2$ .

(4) One water manifold cannot be used for different floors, or it would cause uneven water distribution.

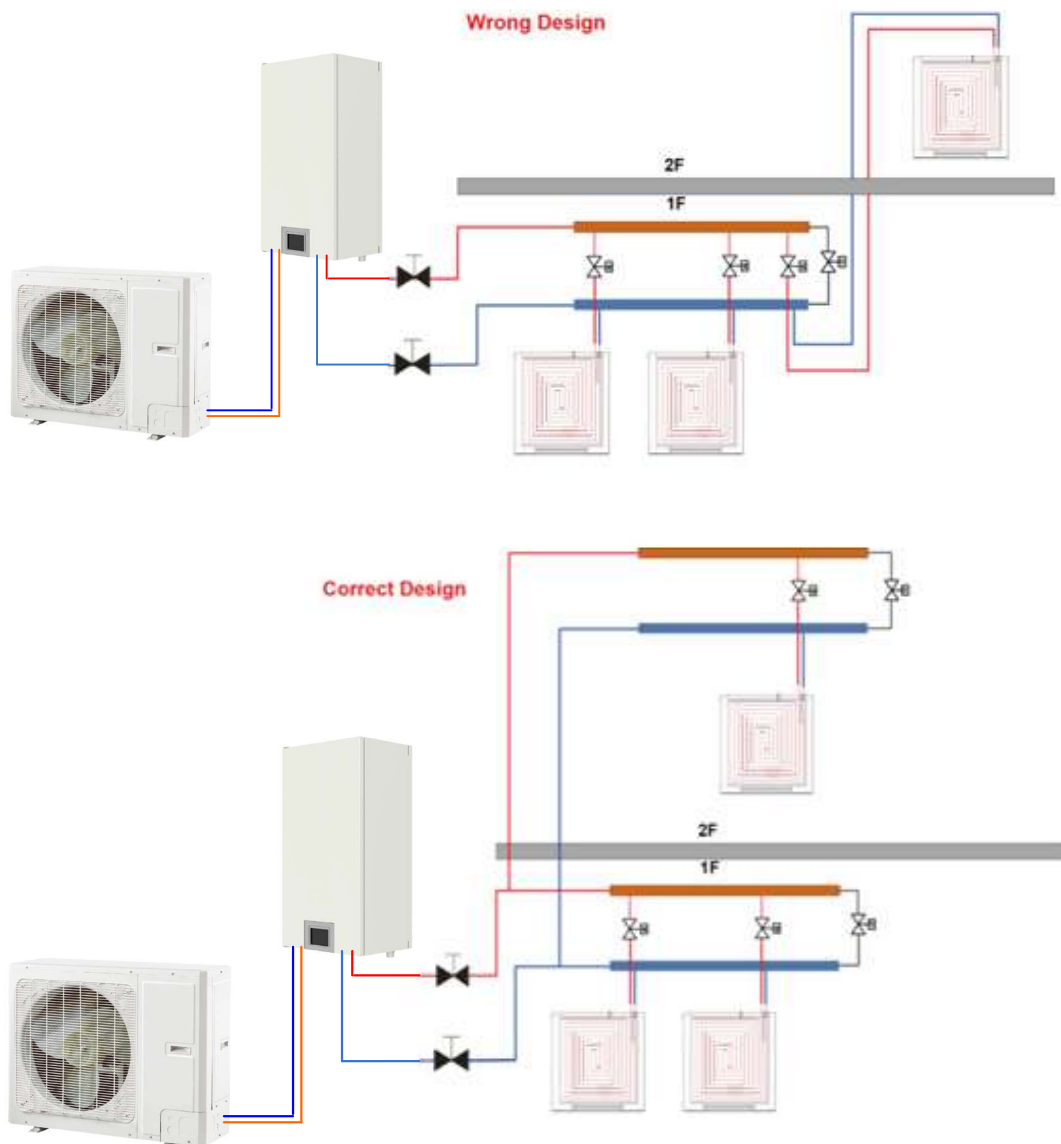

(5) Distance between the unit and the water manifold should be within 15m. If the distance exceeds 20m, then it is required to calculate the hydraulic power.

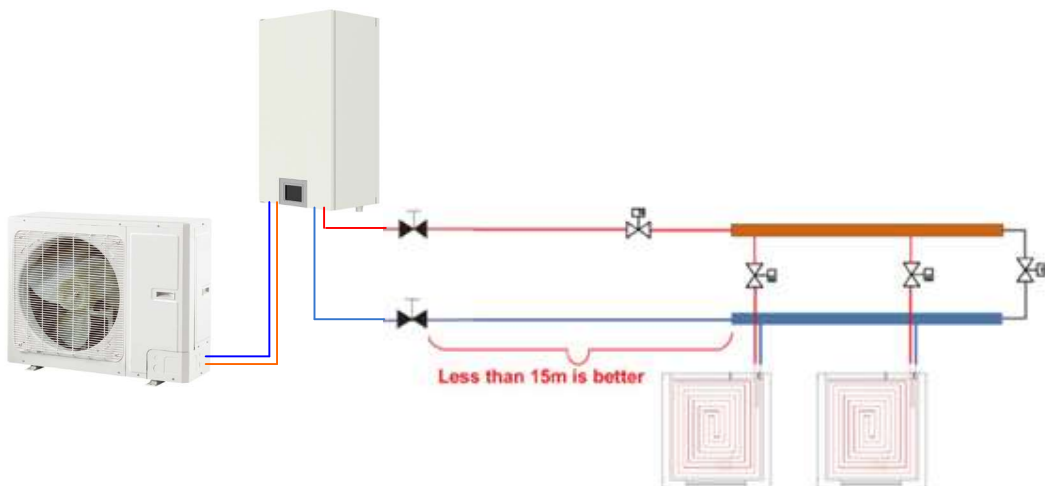

### 3.2 Requirements on Installation of the Water Manifold

- (1) The water manifold should be installed on the wall or inside the special box. For housing constructions, it is generally installed in the kitchen.
- (2) The valve for the water manifold should be installed horizontally and keep a distance of at least 300mm to the ground.
- (3) The water supply valve should be installed upstream of the water manifold and the return valve should be installed downstream of the water manifold.
- (4) A filter is required upstream of the water manifold.

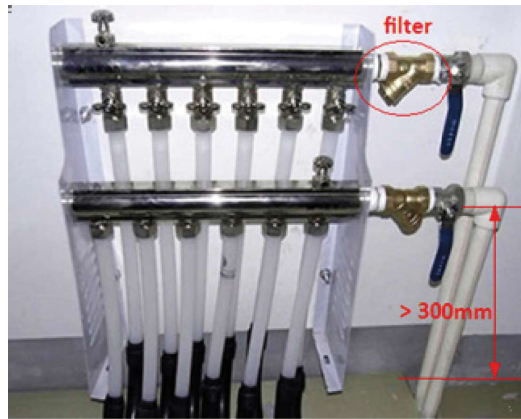

## 4 Section of FCU

### 4.1 FCU Type Selection



The air-water fan coil unit is optional for Unitherm units.

### 4.2 Matching of Capacity

Load of the FCU is recommended to be between 70%~120% of the Unitherm

#### Notes

- (a) When load of the FCU is too small, the unit would start/stop frequently, which is adverse for oil return.
- (b) When load of the FCU is too large, the unit would always run under high frequency, which may bring about energy waste.

Type	Air Volume (m <sup>3</sup> /h)	Cooling Capacity (kW)	Heating Capacity (kW)	Static Pressure (Pa)	Appearance
Wall mounted type	166~1020	2.1~5.4	3.15~8.5	—	
Concealed ceiling type	213~2380	1.85~12.8	3.1~21	12, 30	
Floor ceiling type	213~2040	1.9~10.8	2.8~16.2	—	

Type	Air Volume (m <sup>3</sup> /h)	Cooling Capacity (kW)	Heating Capacity (kW)	Static Pressure (Pa)	Appearance
Cassette type	480~1700	4.5~9	6.8~13.7	—	

## 5 Selection of the Water Tank

### 5.1 Specifications of the Water Tank

SWT200C3EK	220~240V-1N-50Hz
SWT300C3EK	A single coil with the electric heater is integrated, used for floor heating system
SWT200CD3EK	220~240V-1N-50Hz
SWT300CD3EK	Dual coils with the electric heater are integrated, used for floor heating system and the solar system

### 5.2 Volume Selection of the Water Tank

#### 5.2.1 Selection Based on Water Consumption Per Capita

Building Type	Unit	Daily Water Consumption (L)	Water Temperature (°C)
House	Per person, Per day	40~80	60
Villa	Per person, Per day	70~110	60

#### 5.2.2 Selection Based on Sanitary Utensils

Utensil Type	Daily Water Consumption (L)	Water Temperature (°C)
Bathtub, Sprinkler system (with shower)	150	40
Bathtub, Sprinkler system (without shower)	125	40
Shower	70~100	37~40
Wash Basin	3	30

#### 5.2.3 Selection of the Water Tank

Selection of the water tank should consider the flow rate of the shower head, duration of use per person and daily water consumption.

$$\text{Volume of the Water Tank} = \frac{t(\text{design temperature}) - t(\text{entering cold water temperature})}{t(\text{water tank temperature set point}) - t(\text{entering cold water temperature})} \cdot \text{consumption}$$

$$= \alpha \cdot \text{consumption}$$

t (design temperature): generally it is 60°C ;

t (entering cold water temperature): it differs for different regions;

t ( water tank temperature set point): it is the target heating temperature of the water tank.

α: correction factor

**Empirical Values for Volume Correction of the Water Tank**

Flow Rate of the Shower Head (L/min) \ Duration of Use (min/Person)	10	15	20	25	30	40
4	0.48	0.71	0.94	1.18	1.42	1.89
6	0.71	1.06	1.42	1.77	2.12	2.83
8	0.95	1.42	1.89	2.36	2.83	3.77
10	1.18	1.77	2.36	2.95	3.54	4.72
15	1.76	2.65	3.54	4.42	5.31	7.08

Empirical values are worked out under conditions of 80L consumption (per day per person), 8L/min flow rate of the shower head, and 10 minutes use duration per person.

## 6 Examples for Model Selection

### 6.1 General Introduction to the Example Project

For a two-floor house, there is a master room and a bathroom for each floor and both of them require floor heating. Other rooms use the heat pump for heating in winter. The master room covers 28m<sup>2</sup> and the bathroom covers 12m<sup>2</sup>.

### 6.2 Heat Load Calculation

#### 6.2.1 Load Calculation of a Single Floor

Room	Area	Heat Index (W/m <sup>2</sup> )	Heat Load (W)
Master Room	28	82	2296
Bathroom	12	72	900
Total Load	2296+900=3196W		

#### 6.2.2 Arrangement Design of the Underfloor System for A Single Floor

Assumed conditions: the floor is cement or ceramics, the normal external diameter of the heating pipe is 20mm, thickness of the stuffer is 50mm, thickness of PS foam insulation is 20mm, supply water temperature is 45°C, return water temperature is 35°C, indoor design temperature is 20°C.

$$\text{Average Temperature of the Heating Pipe} = (45+35)/2 = 40^\circ\text{C}$$

#### 6.2.3 Arrangement Design of the Underfloor System for the Bath Room

Heat load of the bath room is 900W, heat dissipation per unit area is 75W/m<sup>2</sup>, tube spacing of the heat pipe is 30mm, and heat loss is 25.4 W/m<sup>2</sup>, then the total heat loss is:

$$25.4 \times 12 = 304.8\text{W}$$

Based on the heat load listed in the table above, the heating load for the bathroom is:

$$900 + 304.8 = 1204.8\text{W}$$

According to the formula  $Q = C_p G \Delta T$ , the flow rate of the heating pipe for the bathroom is:

$$G = \frac{Q}{C_p \Delta T} = \frac{1.2048\text{kJ}/1/3600\text{ h}}{4.186\text{kJ}/(\text{kg} \cdot ^\circ\text{C}) \times 1000\text{kg}/\text{m}^3 \times (45-35)^\circ\text{C}} = 0.104\text{m}^3/\text{h}$$

If the outer diameter of the heating pipe is 20mm and thickness is 2mm, then the minimum flow for the heating pipe is:

$$G = \pi/4 D^2 v = 3.14/4 * (20-2*2)^2 * 10^{-6} * 0.25 * 3600 = (0.18\text{m}^3)/\text{h}$$

It can be see that the arranged piping system for the bathroom does not meet the technical requirement and need to be combine the loops with the mater room.

### 6.2.4 Arrangement Design of the Underfloor System for the Master and Bath Rooms

According to the calculation results, the total heat load for the master and bath rooms is 3196W, heat dissipation per unit area is 82W/m<sup>2</sup>, tube spacing of the heating pipe is 300mm, and heat loss is 25.4 W/m<sup>2</sup>, then the total heat loss is:

$$3196+1016=4212W$$

According to the formula  $Q = CpG\Delta T$ , the flow rate is

$$G = \frac{Q}{Cp\Delta T} = \frac{4.212kJ/(1/3600h)}{4.186kJ/(kg \cdot ^\circ C) * 1000kg/m^3 * (45-35)^\circ C} = 0.3622m^3 / > 0.18m^3/h$$

Loop quantity is  $0.3622/0.18=2.012$  and the round-off number is 2.

### 6.2.5 Check

- ◆ Check for the flow rate

$$\frac{0.3622/2}{3.14 * 0.008^2 * 3600} = 0.2503m/s$$

Floor rate of each loop is within 0.25~0.5m/s and the system can run stably.

- ◆ Check for the tube length

When the average tube spacing is 30mm, the required length of the heating pipe per square meter is 3.5m, length of total coils is  $3.5 \times 40 = 140$  and length for each loop is  $140/2 = 70$ .

It can be seen that the length for each loop is less than 120m and it meets the design requirement.

- ◆ Check for the ground average temperature

$$t_p = t_n + 9.82 \times (q_x / 100) \quad 0.969 = 20 + 9.82 \times (82 / 100) \quad 0.969 = 28^\circ C$$

#### Upper Limits and Average Floor Temperature

Average Floor Temperature		
Area	Average Temperature	Maximum Temperature
Long-term Dwelling Area	24~26	28
Short-term Dwelling Area	28~30	32
Nobody Area	35~40	42

### 6.3 Model Selection

Heat demand for a single layer: 3196W

Heat loss for a single layer: 1016W

Total heat load for a single layer: 4212W

Total heat load of the building: 8424W Capacity of the main unit should be larger than

8424W, so we can select: CH-HP10SIRK4

## Control

### 1 Integral Control Concept

#### 1.1 Control Principle Diagram

- ◆ Control Diagram

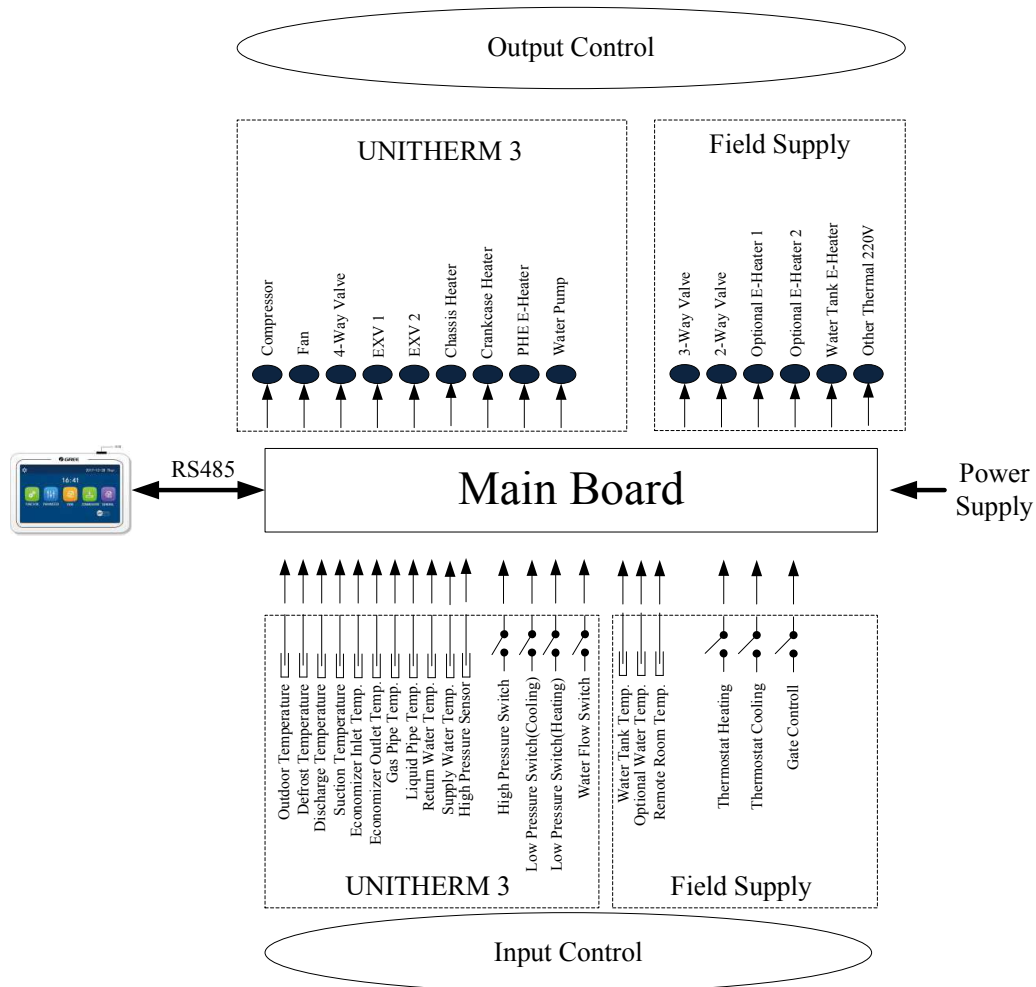

- (1) The outdoor temperature is detected by the sensor installed at fins of the finned heat exchanger, which is mainly used to control the initialization steps of the fan and the electrostatic expansion valve and also limit the maximum running frequency of the compressor. When this sensor fails, the main board will detect it and deliver this error message to the controller and then the unit will fail to start up or shut down.
- (2) The defrost temperature is detected by the sensor installed at the defrosting pipes of the finned heat exchanger, which is mainly used to control defrosting. When this sensor fails at the heating or water heating mode, the compressor will stop and this error will be displayed at the controller. When it fails at the cooling mode, the compressor continues to run but this error will be displayed at the controller.
- (3) The discharge temperature is detected by the sensor installed at the discharge pipe of the compressor, which is mainly used for high discharge temperature protection. When this sensor fails, this error will be displayed at the controller, all loads except the water pump of the solar system and the electric heater of the water tank will stop. Then, the main unit will resume normal running when this error is eliminated.
- (4) The suction temperature is detected by the sensor installed at the suction pipe of the compressor, which is mainly used to control superheating degree. When this sensor fails, this error will be displayed at the controller, all loads except the water pump of the solar system and the electric heater of the water tank will stop. Then, the main unit will resume normal running when this error is eliminated.